

SMAC

Moving Coil Actuators

PRODUCT CATALOG



www.smac-mca.com

The ability to do work and verify its accuracy at the same time.



SMAC Corporate Headquarters and Factory

About SMAC

SMAC was founded in 1990 in Carlsbad, California, USA with the target of developing devices that would automate work done by hands and fingers. By combining this capability with competitive prices SMAC believes it can eventually replace older technologies such as pneumatic cylinders and electric ball screw actuators.

SMAC now manufactures a wide range of precision programmable electric actuators based on its patented moving coil technology. These proprietary moving coil linear motor based designs are technically far ahead of old generation pneumatic and other electric actuators, including moving magnet linear motors. Our technological edge, combined with continuous cost-down/quality-up processes and its worldwide sales basis makes SMAC a leading mechatronics manufacturer in the world today.

SMAC devices have the ability to find surfaces without disturbing them, i.e., "Soft-Land™ capability." This makes them "Mechatronic Actuators."

SMAC Moving Coil Actuators are much more sophisticated than the simple devices such as solenoids or air cylinders. The variables involved in the work are programmable. So force, distance, and speed all can be varied as needed. The devices also have built-in feedback sensing that can report if the desired work was accomplished or not. The devices have the ability to find surfaces without disturbing them, i.e., "Soft-Land™ capability." This makes them "Mechatronic Actuators."

The actuators are designed to perform at exceptionally high speeds or very low speeds and with sub-micron accuracy and validatable repeatability with as precise as 1 ms response time. This makes them ideal for a wide range of positioning, measuring, inspection, and pick and place applications, particularly where 100% verification is required.

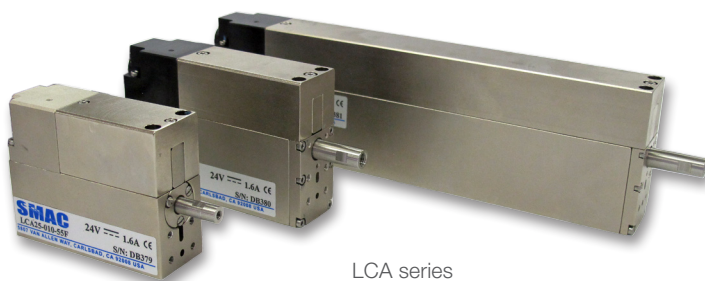

LCA series

How Moving Coil Actuators Work

Moving coil actuators work on the same principle as an audio loudspeaker. They consist of a moving carriage with an attached coil surrounding a powerful, permanent magnet. Current passing through the coil induces an electro-magnetic force, according to Fleming's left-hand rule. Varying the direction and amplitude of the current varies the induced force, allowing you to control the motion. The result is a device with few moving parts, low friction and zero backlash with excellent dynamic properties.

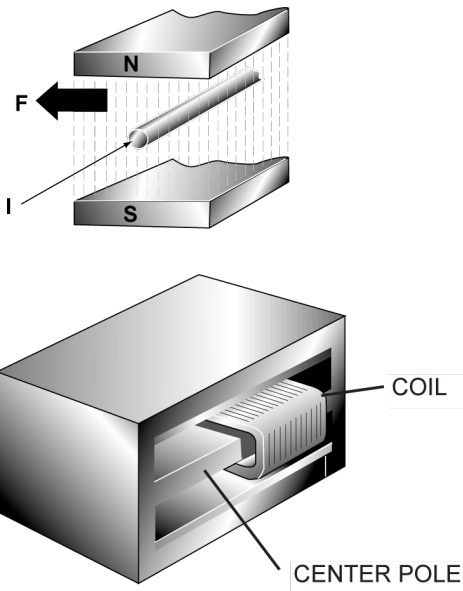

$$F \propto N I B$$

where: **F** is the force generated

N is the number of turns in the winding (Constant)

I is the current flowing through the winding and

B is the magnetic flux (Constant)

Therefore, doubling **I (current)** doubles **F (Force)**.

Other voice coil actuators give no provision for position feedback, but all SMAC actuators include a precision, non-contact linear encoder. This allows closed-loop servo control of motion in position and velocity modes and real time monitoring of position in all operating modes.

These unique features allowed SMAC to develop the Soft-Land™ routine, which has permitted applications simply not possible with other technologies.

Benefits of Moving Coil Technology

- Lower moving mass with the moving coil actuator means extremely high acceleration and velocity, as opposed to the heavier "moving magnet" technology used in most linear motors.
- Safe and energy efficient: operates at low current, typically at 1.5 amps at 24 volt DC.
- Quiet (< 55dB), airless operation: no expensive compressed air generation required. No air consumption or air leaks to attend to. No compressed air generating environmental particulate contamination.
- Force control is precise and repeatable since there is no pressure valves, no force fluctuations caused by air pressure fluctuations.

Electric Cylinder Actuators

High speed, compact and price-competitive cylinder actuators that provide an alternative to pneumatic cylinders with superior performance. The conventional cylinder actuator shape and multiple mounting points allow the electric cylinders to be directly retrofitted in most cases. When you take into account the operating cost of compressed air, unit life expectancies, replacement costs, downtime and changeover times, SMAC's actuators often have a significantly lower total cost than air cylinders and electromechanical alternatives.

Linear:

- Stroke up to 25mm, force up to 66N, position encoder resolution 5 μ m standard, 1 μ m option.
- Programmable force, position, acceleration and velocity.
- Built-in controller type is available for simple installation and effective use of space. (See page 13)
- Optional IP65 and IP67, dust-proof and waterproof features, are available.

Electric Cylinder | CBL series

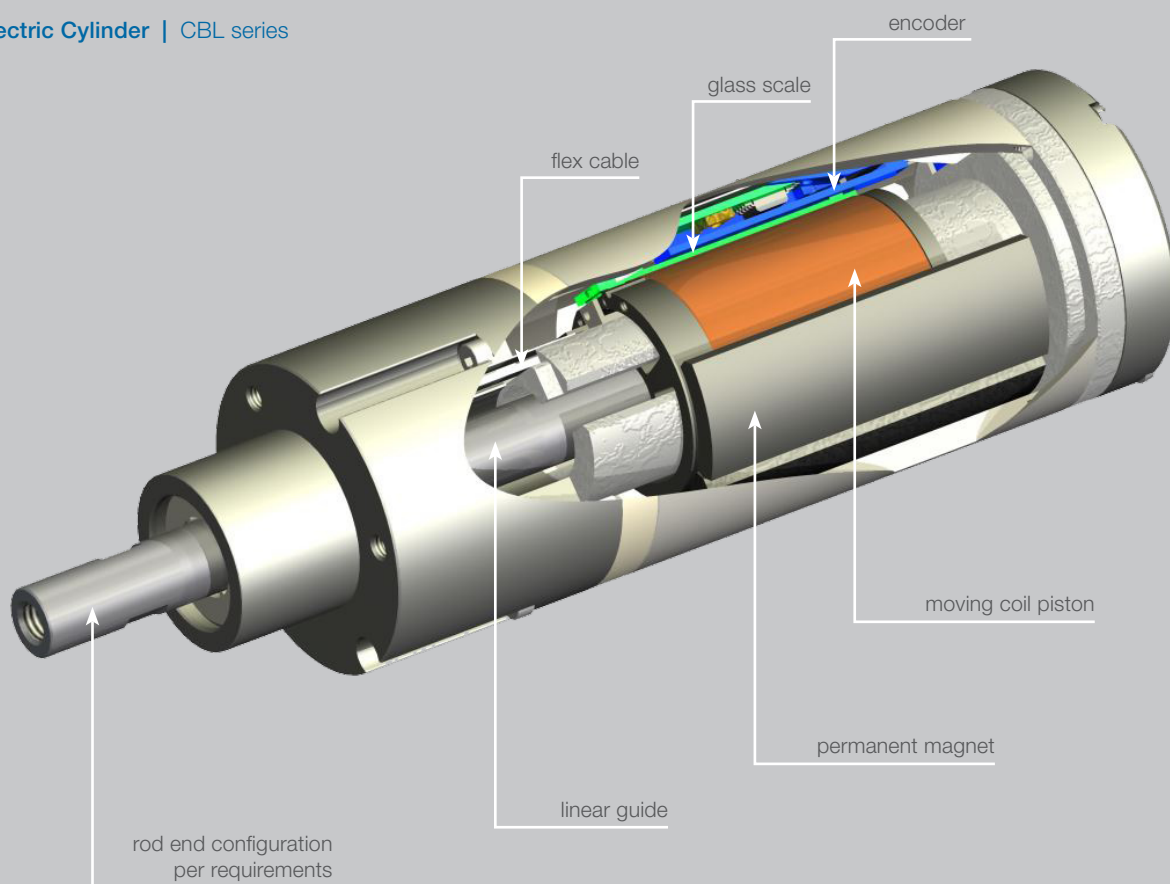

LINEAR & LINEAR ROTARY ACTUATORS

Linear and Linear Rotary Actuators

A comprehensive selection of programmable linear actuators are offered in a wide range of sizes, styles and options to satisfy your most demanding application requirements.

The precision Z-theta motion within one small actuator, providing a convenient pick, orient and place. A wide variety of linear rotary actuators are also offered with either direct drive or gearbox equipped rotary units.

Linear:

- Stroke up to 250mm, force up to 500N, position encoder resolution 5µm standard, 1 and 0.1µm option for most actuators.
- Programmable force, position, acceleration and velocity.

Rotary:

- Multi-turn servo motor, torque up to 4.5Nm, velocity up to 5000 rpm, resolution up to 132,000 increments per revolution.
- Programmable force/torque, and position.
- The vacuum passage built in the shaft through the rotary motor prevents dust build up in the unit.

Linear Rotary | LAR series

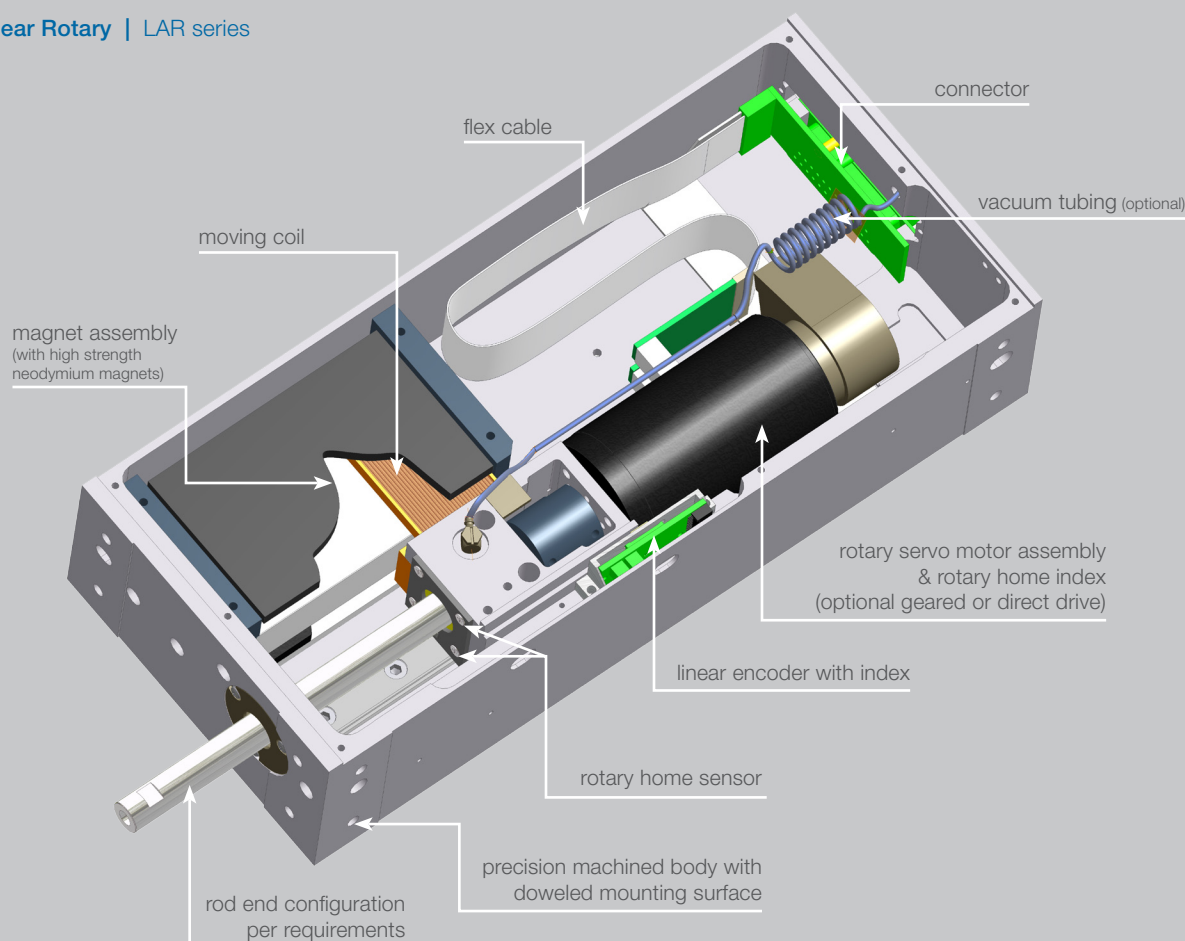

Programmability and Operating Modes

By using SMAC controllers all of our products are programmable using 3 different modes independently and controlling position, velocity, and force. This allows their performance characteristics to be tightly monitored. Pass/fail windows for any of these parameters can be set - useful for error reporting and testing applications.

Position mode

Position mode will allow the actuator to be moved to any position along the stroke using a given acceleration, velocity and force. It is possible to make absolute, relative and "learned position" moves. The force necessary to hold a given position can also be measured. This is called "holding force" and is used in applications such as switch testing.

Velocity mode

Velocity mode allows the actuator to be moved with a given velocity, acceleration, force and direction. Velocity (i.e. position vs. time) is closed-loop using feedback from the encoder, giving precise velocity control. Position and position error (the difference between actual position and desired position at a given time) can be interrogated in real time during motion. Typically used for constant speed scanning applications and Soft-Land™ routines.

Force mode

In Force mode, current in the coil is controlled to give a programmed force output. Position and velocity are open loop, using no feedback from the encoder, but actual position can still be monitored in real time. Used in applications such as tensile and compression testing.

SMAC Unique Features and Advantages

- **Fully programmable** in **Position, Acceleration, Velocity** and **Force**.
- **Soft-Land™** capability: apply controlled light force without damaging parts/material being handled.
- Direct drive = no backlash, a very high degree of accuracy & repeatability.
- Sub-micron resolution (5µm to 100nm).
- **Long operation life** = typical MTBF of over 100 million cycles.

SMAC Actuators Give You Flexibility

- Integrated position measuring system with glass scale and optical reader head (non contact).
- Ability to switch between operations - force, position and velocity mode - at any time.
- "On the fly" adjustable movement allows quick changeover.
- Constant force monitoring and control.
- Digital and analog input/output channels.
- SMAC linear motors are a servo system, hence they can be programmed to decelerate smoothly and quickly. Mechanical slamming can be totally eliminated.
- Competitively priced electric actuators that offer all of the above features and benefits.

What is a Soft-Land™?

The Soft-Land™ is a patented unique software routine which allows an SMAC actuator to approach a surface at an unknown distance and land on it with a programmed force that can be as low as 0.1N. It gives extremely accurate sensing of product location or dimensions. This is particularly useful for handling delicate or high value components, such as surface mount chips, but other uses are emerging all the time. The routine takes advantage of the SMAC actuator's unique ability to control applied force while monitoring position in real time and is available for use with all SMAC actuators.

Soft-Land™ is a patented unique capability that allows actuators to approach a surface at an unknown distance and land on it with a programmed force.

The routine consists of a controlled low force approach in velocity mode, while the position error is constantly monitored. Once contact is made the position error builds up until a pre-programmed figure is reached - resulting in the rod maintaining position on the surface of the component.

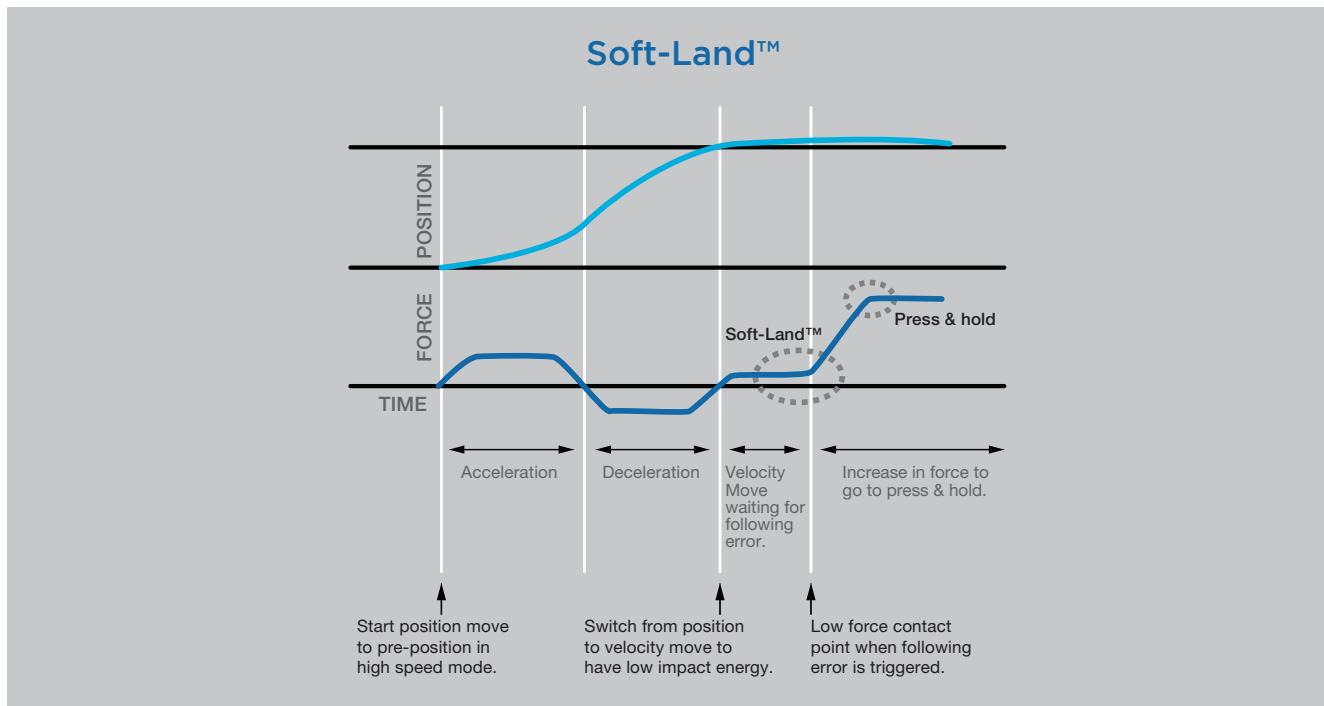

A typical Soft-Land™ routine might be as follows:

1. High speed approach in Position mode to a "safe" distance from the part.
2. Switch to Velocity mode, setting a low force and velocity.
3. Slowly approach the part, monitoring position error.
4. If position error goes outside of a programmed window, the actuator has met an obstruction (i.e. landed on the part) and the Soft-Land™ routine is completed.
5. It is also possible to set a position window where the component should be located, if it is not located within a certain position, the actuator will retract.

PRODUCT OVERVIEW

ELECTRIC CYLINDERS Stroke [mm] 10 - 25 | Peak Fore [N]: 1.5 - 130



CAL12
Stroke [mm]: 10
Force [N]: 1.5



CBL35
Stroke [mm]: 10, 15, 25
Force [N]: 8.5-22



CBL50
Stroke [mm]: 10, 25
Force [N]: 23-100



CBL35C with Built-in Controller
Stroke [mm]: 10, 15, 25
Force [N]: 8.5-22



CBL50C with Built-in Controller
Stroke [mm]: 10, 25
Force [N]: 23-100



CTL50
Stroke [mm]: 10
Force [N]: 47

LINEAR & LINEAR ROTARY ACTUATORS Stroke [mm] 10 - 250 | Peak Force [N]: 2.6 - 500



CBR100
Stroke [mm]: 50,100,150
Force [N]: 85



LCA6
Stroke [mm]: 10
Force [N]: 3.5



LCA8
Stroke [mm]: 10, 25, 50
Force [N]: 2.6 - 4



LCA13 / LCR13
Stroke [mm]: 25, 35, 50
Force [N]: 7 - 14



LCA16 / LCR16
Stroke [mm]: 10 - 50
Force [N]: 7 - 14

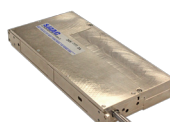

LCA20/LCR20
Stroke [mm]: 25
Force [N]: 25



LCA25
Stroke [mm]: 10 - 200
Force [N]: 7.4 - 22



LBL25
Stroke [mm]: 25 - 200
Force [N]: 60

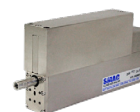

LCB25
Stroke [mm]: 10 - 25
Force [N]: 40 - 80



LCA32
Stroke [mm]: 12
Force [N]: 76

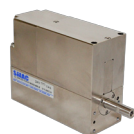

LCA50
Stroke [mm]: 25 - 250
Force [N]: 45 - 130



LAR31
Stroke [mm]: 30, 50
Force [N]: 11, 20



LAL35 / LAR35
Stroke [mm]: 25, 50, 100
Force [N]: 6 - 31.5

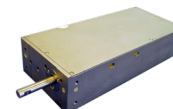

LAL55 / LAR55
Stroke [mm]: 50, 100, 150
Force [N]: 13 - 40



LAL95 / LAR95
Stroke [mm]: 15, 25, 50
Force [N]: 65 - 195



LAL300 / LAR300
Stroke [mm]: 30, 50, 100
Force [N]: 80 - 250



LAL500
Stroke [mm]: 25, 50
Force [N]: 500



LBL40 / LBR40
Stroke [mm]: 50
Force [N]: 500

PRODUCT OVERVIEW

LINEAR SLIDE ACTUATORS Stroke [mm] 5 - 250 | Peak Force [N]: 2.1 - 202



LBS17
Stroke [mm]: 5
Force [N]: 13.5



LCS8
Stroke [mm]: 10, 25, 50
Force [N]: 2.6-4



LCS25
Stroke [mm]: 10-200
Force [N]: 7.4-22

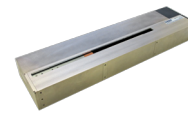

LCS50
Stroke [mm]: 25-250
Force [N]: 45-90



SLA10
Stroke [mm]: 5, 10
Force [N]: 2.1



SLA25
Stroke [mm]: 10
Force [N]: 4

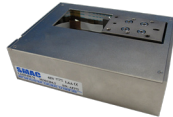

LAS35
Stroke [mm]: 25, 50, 100
Force [N]: 6-31.5

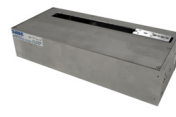

LAS55
Stroke [mm]: 50, 100, 150
Force [N]: 13-40

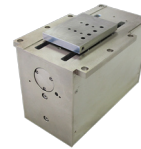

LAS95
Stroke [mm]: 15, 25, 50
Force [N]: 65-185



LAS300
Stroke [mm]: 50
Force [N]: 202

GRIPPERS & XY STAGES Stroke [mm] 10 - 30 | Peak Force [N]: 3.1 - 45



MGR7
Stroke [mm]: 10
Force [N]: 3.8



GRP20
Stroke [mm]: 10
Force [N]: 8



GRP35
Stroke [mm]: 30
Force [N]: 25, 26



GRP50
Stroke [mm]: 30
Force [N]: 35, 45

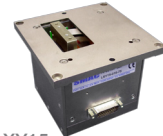

LXY15
Stroke [mm]: 15
Force [N]: 22



LXY25
Stroke [mm]: 25
Force [N]: 42

CONTROLLERS & AMPLIFIERS



VLC
"Very Low Cost" single or 2-axis DC brushed/brushless motor controller/driver



CBC / CBC-I-3/6
Single-axis miniature controller with a built-in amplifier



CBC-EIP / CBC-ECT
Integrated single axis servo motor controller/driver with Ethernet/IP and EtherCAT connectivity



LCC-10 (LCC-11)
Single-axis brushless controller with built-in amplifier



LAC-1
Single-axis controller with a built-in amplifier



LAC-25
2-axis controller with a built-in amplifier



LAC-26
2-axis controller with a built-in amplifier



MC-2
Master Controller with up to 127 axis

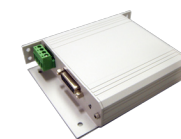

LAD-1
Single-axis smart driver



MIOE-8/8
Expansion I/O module for LAC-1, LAC-25 and LAC-45

PART NUMBERING SYSTEM

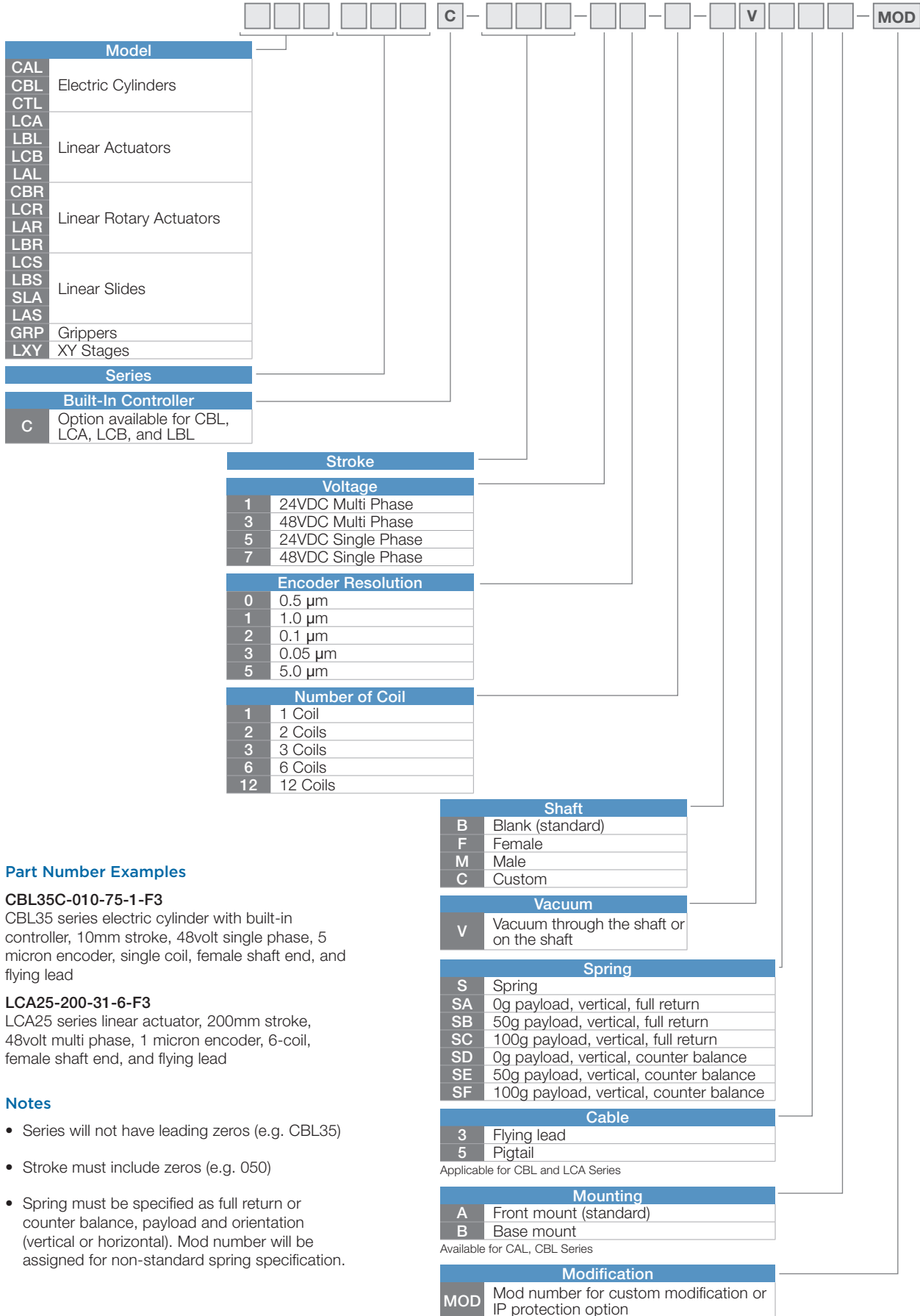

Part Number Examples

CBL35C-010-75-1-F3

CBL35 series electric cylinder with built-in controller, 10mm stroke, 48volt single phase, 5 micron encoder, single coil, female shaft end, and flying lead

LCA25-200-31-6-F3

LCA25 series linear actuator, 200mm stroke, 48volt multi phase, 1 micron encoder, 6-coil, female shaft end, and flying lead

Notes

- Series will not have leading zeros (e.g. CBL35)
- Stroke must include zeros (e.g. 050)
- Spring must be specified as full return or counter balance, payload and orientation (vertical or horizontal). Mod number will be assigned for non-standard spring specification.

SMAC Actuators' Unique Features



Soft-Land™

A patented capability to apply controlled light force without damaging parts/materials being handled.



Feedback

Built-in sensing that can report if the desired work was accomplished or not. It can be used for Data Acquisition.



Linear Rotary Motion

The precision Z-theta motion within one small compact actuator, providing convenient pick, orient, and place movements.



IP Protection

Optional IP65 and IP67, dustproof and waterproof features.



Graphical User Interface (GUI)

SMAC GUI provides a simple and straightforward way to quickly configure motion parameters of a variety of SMAC actuators and controllers. Application-based GUIs are also available.

Direct replacement of air cylinders. High speed, compact and price-competitive cylinder actuators are the ideal solution for new machine designs and upgrade.



- ✓ Direct replacement of air cylinders
- ✓ Cost competitive
- ✓ Long life expectancy, typically over 100 million cycles
- ✓ IP protection optional

Part Number	Voltage [DC]	Size: Dia.x L [mm]	Stroke [mm]	Peak Force [N]	Continuous Force [N]	Force Constance [N/A]	Maximum Current [Amp]	Moving Mass [kg]	Weight [kg]
CAL12-010-55-1	24	Ø12x112	10	1.5	0.4	1	1.5	0.01	0.08
CBL35-010-55-1	24	Ø35x96	10	15	6	9	1.5	0.04	0.45
CBL35-010-75-1	48	Ø35x96	10	22	8.8	13.4	1.6	0.04	0.45
CBL35-015-55-1	24	Ø35x101	15	10	4	7	1.5	0.06	0.5
CBL35-015-75-1	48	Ø35x101	15	14	5.6	8.8	1.6	0.06	0.5
CBL35-025-55-1	24	Ø35x111	25	8.5	3.4	5.8	1.5	0.06	0.6
CBL35-025-75-1	48	Ø35x111	25	14	5.6	8.8	1.6	0.06	0.6
CBL50-010-55-1	24	Ø50x123	10	33	13	22	1.5	0.14	1.14
CBL50-010-55-2	24	Ø50x166	10	49	19	16	3	0.21	1.7
CBL50-010-75-1	48	Ø50x123	10	40	16	26	1.5	0.14	1.14
CBL50-010-75-2	48	Ø50x166	10	100	40	33	3	0.21	1.7
CBL50-025-55-1	24	Ø50x138	25	23	9	15	1.5	0.15	1.3
CBL50-025-55-2	24	Ø50x203	25	40	16	13	3	0.24	2.1
CBL50-025-75-1	48	Ø50x138	25	40	16	26	1.5	0.15	1.3
CBL50-025-75-2	48	Ø50x203	25	70	28	23	3	0.24	2.1
CTL50-010-75-2	48	Ø48x160	10	47	18	12.7	3	0.19	1.1

NOTE: For any SMAC Moving Coil Actuators, the maximum recommended continuous duty current is 600mA supplied to the actuator over a 1 second period. For anything beyond this in terms of current draw or time please consult the factory. We manufacture actuators to suit our customers' requirements. Please call us if you do not find the right actuator in this list.



CAL12



CBL35



CBL50



CTL50

Options & Modifications (Consult factory for availability)

- Encoder resolutions ----- 5µm standard. 1µm optional.
- Shaft ends ----- Male, Female, Blank and Custom.
- Return spring ----- Prevents the shaft from dropping during vertical operation when power is cut.
- Vacuum ----- Vacuum through the shaft or on the shaft for pick and place applications.
- Mount ----- Front mount (standard), base mount optional. Threaded Mount is available for CAL12 series only.
- Dust/Waterproof ----- IP65/67 protection is available with CBL series.

ELECTRIC CYLINDERS WITH BUILT-IN CONTROLLER

A complete self-contained unit, suggested for replacement of pneumatic cylinders where increased lifetime, speed and control are desirable.



- ✓ Built-in controller
- ✓ Airless and quiet operation
- ✓ Graphical User Interface for simple set-up
- ✓ IP protection optional

Part Number	Voltage [DC]	Size: Dia.x L [mm]	Stroke [mm]	Peak Force [N]	Continuous Force [N]	Force Constance [N/A]	Maximum Current [Amp]	Moving Mass [kg]	Weight [kg]
CBL35C-010-55-1	24	Ø35x135	10	15	6	9	1.5	0.04	0.52
CBL35C-010-75-1	48	Ø35x135	10	22	8.8	13.4	1.6	0.04	0.52
CBL35C-015-55-1	24	Ø35x140	15	10	4	7	1.5	0.06	0.57
CBL35C-015-75-1	48	Ø35x140	15	14	5.6	8.8	1.6	0.06	0.57
CBL35C-025-55-1	24	Ø35x150	25	8.5	3.4	5.8	1.5	0.06	0.67
CBL35C-025-75-1	48	Ø35x150	25	14	5.6	8.8	1.6	0.06	0.67
CBL50C-010-55-1	24	Ø50x177.5	10	33	13	22	1.5	0.14	1.29
CBL50C-010-55-2	24	Ø50x220.5	10	49	19	16	3	0.21	1.8
CBL50C-010-75-1	48	Ø50x177.5	10	40	16	26	1.5	0.14	1.29
CBL50C-010-75-2	48	Ø50x220.5	10	100	40	33	3	0.21	1.8
CBL50C-025-55-1	24	Ø50x192.5	25	23	9	15	1.5	0.15	1.38
CBL50C-025-55-2	24	Ø50x258	25	40	16	13	3	0.24	2.25
CBL50C-025-75-1	48	Ø50x192.5	25	40	16	26	1.5	0.15	1.38
CBL50C-025-75-2	48	Ø50x255.5	25	70	28	23	3	0.24	2.25

NOTE: For any SMAC Moving Coil Actuators, the maximum recommended continuous duty current is 600mA supplied to the actuator over a 1 second period. For anything beyond this in terms of current draw or time please consult the factory. We manufacture actuators to suit our customers' requirements. Please call us if you do not find the right actuator in this list.



CBL35C



CBL50C



Options & Modifications (Consult factory for availability)

- Built-in Controller ----- Simple installation and effective use of space.
- Encoder resolutions ----- 5µm standard. 1µm optional.
- Shaft ends ----- Male, Female, Blank and Custom.
- Return spring ----- Prevents the shaft from dropping during vertical operation when power is cut.
- Vacuum ----- Vacuum through the shaft or on the shaft for pick and place applications.
- Mount ----- Front mount only
- Dust/Waterproof ----- IP65/67 protection is available.
- Cable ----- Flying lead only

LINEAR ACTUATORS | LCA SERIES

Developed as next generation servo motor based on moving coil technology. Snap-Together design controls tight tolerance stack-up to assure high product quality at a competitive price.



- ✓ Cost effective
- ✓ Built-in lubrication for long operation life
- ✓ High cycle and acceleration
- ✓ IP protection optional

Part Number	Voltage [DC]	Size: LxWxH [mm]	Stroke [mm]	Peak Force [N]	Continuous Force [N]	Force Constant [N/A]	Maximum Current [Amp]	Moving Mass [kg]	Weight [kg]
LCA6-010-55-3	24	135x60x6	10	3.5	(*)	2.9	1.2	0.037	0.21
LCA8-010-55-2	24	95x50x8	10	4	(*)	3.2	1.7	0.025	0.16
LCA8-025-15-3	24	110x50x8	25	2.6	(*)	2.2	1.3	0.027	0.18
LCA8-050-15-3	24	135x50x8	50	2.6	(*)	2.2	1.3	0.03	0.22
LCA13-025-55-2	24	155x75x13	25	7	2.8	2.5	3	0.08	0.4
LCA13-035-15-6	24	180x75x13	35	14	5.6	9.4	1.5	0.12	0.52
LCA13-050-15-6	24	210x75x13	50	14	5.6	9.4	1.5	0.125	0.6
LCA16-010-55-2	24	110x60x16	10	6	2.5	4.3	1.5	0.045	0.435
LCA16-010-75-2	48	110x60x16	10	13	5	6.5	1.5	0.045	0.435
LCA16-025-55-2	24	155x75x16	25	7	2.8	2.5	3	0.08	0.47
LCA16-035-15-6	24	180x75x16	35	14	5.6	9.4	1.5	0.12	0.62
LCA16-050-15-6	24	210x75x16	50	14	5.6	9.4	1.5	0.125	0.73
LCA20-025-55-2	24	155x75x20	25	9	3.6	3	3	0.08	0.71
LCA20-025-75-2	48	155x75x20	25	25	10	7	3.6	0.08	0.71
LCA25-010-55-1	24	70x55x25	10	8	3	6	1.5	0.04	0.27
LCA25-010-55-2	24	130x60x25	10	16	6	5.5	3	0.085	0.45
LCA25-010-75-1	48	70x55x25	10	12	5	8	1.5	0.04	0.27
LCA25-010-75-2	48	130x60x25	10	22	9	8	3	0.085	0.45
LCA25-025-15-6	24	130x60x25	25	15	6	13	1.6	0.076	0.55
LCA25-025-35-6	48	130x60x25	25	20.5	8.2	14.5	1.6	0.076	0.55
LCA25-025-55-2	24	130x60x25	25	7.4	2.9	2.5	3	0.076	0.55
LCA25-025-75-2	48	130x60x25	25	9.2	3.6	3	3	0.076	0.55
LCA25-050-15-6	24	155x60x25	50	15	6	13	1.6	0.082	*
LCA25-050-35-6	48	155x60x25	50	20.5	8.2	14.5	1.6	0.082	*
LCA25-100-15-6	24	205x60x25	100	15	6	13	1.6	0.1	*
LCA25-100-35-6	48	205x60x25	100	20.5	8.2	14.5	1.6	0.1	*
LCA25-150-15-6	24	258x60x25	150	15	6	13	1.6	0.12	*
LCA25-150-35-6	48	258x60x25	150	20.5	8.2	14.5	1.6	0.12	*
LCA25-200-15-6	24	310x60x25	200	15	6	13	1.6	0.14	1.3
LCA25-200-35-6	48	310x60x25	200	20.5	8.2	14.5	1.6	0.14	1.3

Part Number	Voltage [DC]	Size: LxWxH [mm]	Stroke [mm]	Peak Force [N]	Continuous Force [N]	Force Constant [N/A]	Maximum Current [Amp]	Moving Mass [kg]	Weight [kg]
LCA32-012-75-3	48	100x57x31	12	76	30	13	6	0.076	0.75
LCA50-010-75-2	48	125x50x100	10	130	50	46	2.8	0.43	2.6
LCA50-025-75-1	48	125x100x50	25	50	20	40	1.5	0.335	2.16
LCA50-050-35-6	48	250x115x50	50	90	36	67	1.7	0.665	*
LCA50-050-75-1	48	125x100x50	50	45	18	30	1.6	0.335	2.58
LCA50-050-75-2	48	215x100x50	50	85	34	30	3	0.465	4.34
LCA50-100-35-6	48	300x115x50	100	90	36	67	1.7	0.66	5.7
LCA50-150-35-6	48	350x115x50	150	90	36	67	1.7	0.825	8
LCA50-250-35-6	48	450x115x50	250	90	36	67	1.7	1	14

NOTE: For any SMAC Moving Coil Actuators, the maximum recommended continuous duty current is 600mA supplied to the actuator over a 1 second period. For anything beyond this in terms of current draw or time please consult the factory. We manufacture actuators to suit our customers' requirements. Please call us if you do not find the right actuator in this list. Linear actuators are also available as linear slides (see page 20). (*)Consult factory



LCA6



LCA8



LCA13



LCA16/LCA20



LCA25



LCA32

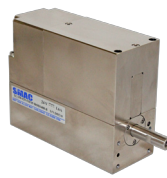

LCA50



Options & Modifications (Consult factory for availability)

- Linear encoder resolutions ----- 5µm standard. 1µm and 0.1µm optional for most units. Consult factory for availability.
- Shaft ends ----- Male, Female, Blank and Custom (check availability of custom option).
- Return spring ----- Prevents the shaft from dropping during vertical operation when power is cut.
- Vacuum ----- Vacuum through the shaft or on the shaft for pick and place applications.
- Extended nose bushing ----- For tighter shaft run-out and higher side load onto the shaft.
- Increase of force & acceleration ----- 48 volt coil and double coil options are available for some units with 24 volt single coil.
- Increase of force accuracy/lifetime ----- Low-friction linear guide/extra-long preload linear guide.
- Dust/Waterproof ----- IP65/67 protection is available with LCA50 series.

LINEAR ACTUATORS | LBL/LCB SERIES

The LBL and LCB are price competitive solutions for some higher force applications, previously dominated by pneumatic actuators.



- ✓ High force and acceleration
- ✓ Cost effective

Part Number	Voltage [DC]	Size: LxWxH [mm]	Stroke [mm]	Peak Force [N]	Continuous Force [N]	Force Constant [N/A]	Maximum Current [Amp]	Moving Mass [kg]	Weight [kg]
LBL25-025-35-3	48	175x127x25	25	70	28	31.2	2.5	0.19	-
LBL25-050-35-3	48	200x127x25	50	70	28	31.2	2.5	0.19	-
LBL25-100-35-3	48	280x127x25	100	70	28	31.2	2.5	0.19	2
LBL25-150-35-3	48	310x127x25	150	70	28	31.2	2.5	0.19	3.8
LBL25-200-35-3	48	360x127x25	200	70	28	31.2	2.5	0.21	4.56
LBL40-050-35-3	48	335x160x40	50	100	40	40	2.5	0.9	7.2
LCB25-010-75-3	48	155x81.6x29.8	10	80	30	22	3.6	0.14	1.17
LCB25-015-55-2	24	100x81.6x30	15	47	18	12.7	3.7	0.12	1.01
LCB25-025-75-2	48	155x81.6x25	25	40	16	30	1.3	0.12	1

NOTE: For any SMAC Moving Coil Actuators, the maximum recommended continuous duty current is 600mA supplied to the actuator over a 1 second period. For anything beyond this in terms of current draw or time please consult the factory. We manufacture actuators to suit our customers' requirements. Please call us if you do not find the right actuator in this list.



Options & Modifications (Consult factory for availability)

- Linear encoder resolutions ----- 5µm standard and 1µm optional.
- Shaft ends ----- Male, Female, Blank and Custom (check availability of custom option).
- Return spring ----- Prevents the shaft from dropping during vertical operation when power is cut.
- Vacuum ----- Vacuum through the shaft or on the shaft for pick and place applications.
- Extended nose bushing ----- For tighter shaft run-out and higher side load onto the shaft.
- Increase of force accuracy/lifetime ----- Low-friction linear guide/extra-long preload linear guide.

LINEAR ACTUATORS | LAL SERIES

SMAC's original series of linear actuators with stroke up to 150mm and a peak force of up to 500N. As with all SMAC actuators, the LAL has independent control of position, speed, and force.



- ✓ Soft-Land™ capability and precise force control
- ✓ High cycle
- ✓ Data feedback

Part Number	Voltage [DC]	Size: LxWxH [mm]	Stroke [mm]	Peak Force [N]	Continuous Force [N]	Force Constant [N/A]	Maximum Current [Amp]	Moving Mass [kg]	Weight [kg]
LAL35-025-55-2	24	135x90x35	25	31.5	12.6	15.5	2.9	0.19	1.06
LAL35-025-75-1	48	135x90x35	25	18	7	10	1.3	0.12	0.95
LAL35-050-55-1	24	135x90x35	50	10	4	7	1.6	0.13	1.1
LAL35-050-75-1	48	135x90x35	50	12.5	5	10	1.3	0.13	1.1
LAL35-100-55-1	24	135x90x35	100	6	2.4	3.5	1.6	0.1	1.7
LAL55-050-55-1	24	250x110x55	50	25	10	19	1.3	0.3	3
LAL55-050-75-1	48	250x110x55	50	40	16	24.5	1.8	0.3	3
LAL55-100-55-1	24	250x110x55	100	16	6.4	13	1.3	0.3	3.8
LAL55-100-75-1	48	250x110x55	100	25	10	17	1.8	0.3	3.8
LAL55-150-55-1	24	250x110x55	150	13	5	10	1.3	0.4	4.5
LAL55-150-75-1	48	250x110x55	150	19.5	8	12.5	1.8	0.4	4.5
LAL95-015-75-1	48	90x70x95	15	84	33	53	1.7	0.25	2.2
LAL95-015-75-2	48	147x70x95	15	185	74	58	3.2	0.5	3
LAL95-025-75-2	48	180x70x95	25	162	65	52	3.1	0.58	3.75
LAL95-050-75-1	48	147x70x95	50	65	26	41	1.7	0.25	3
LAL300-030-75-1	48	120x85x120	30	115	46	76	1.6	0.45	4.8
LAL300-030-75-2	48	210x85x120	30	250	100	87.3	3	0.8	7.8
LAL300-050-75-2	48	210x85x120	50	202	80	86	3	0.8	8.8
LAL300-100-75-1	48	210x85x120	100	80	32	43	2	0.7	7.9
LAL500-025-75-2	48	300x140x200	25	500	200	166	3	1.6	26.5
LAL500-050-75-2	48	300x140x200	50	500	200	100	4	1.6	26.5

NOTE: For any SMAC Moving Coil Actuators, the maximum recommended continuous duty current is 600mA supplied to the actuator over a 1 second period. For anything beyond this in terms of current draw or time please consult the factory. We manufacture actuators to suit our customers' requirements. Please call us if you do not find the right actuator in this list. Linear actuators are also available as linear slides (see page 21)

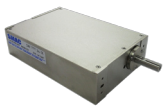

LAL35

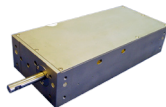

LAL55



LAL95



LAL300



LAL500

Options & Modifications (Consult factory for availability)

Linear encoder resolutions	5µm standard. 1µm and 0.1µm optional for most units. Consult factory for availability.
Shaft ends	Male, Female, Blank and Custom (check availability of custom option).
Return spring	Prevents the shaft from dropping during vertical operation when power is cut.
Vacuum	Vacuum through the shaft or on the shaft for pick and place applications.
Extended nose bushing	For tighter shaft run-out and higher side load onto the shaft.
Increase of force & acceleration	48 volt coil and double coil options are available for some units with 24 volt single coil.
Increase of force accuracy/lifetime	Low-friction linear guide/extra-long preload linear guide.
Dust/Waterproof	IP65/67 protection is available with LAL95 series.

LINEAR ROTARY ACTUATORS | CBR/LBR/LCR SERIES

The CBR offers independent linear and rotary motion within one conventional cylinder shape.

The LBR and LCR are slim, stackable Z-theta actuators.



- ✓ Independent linear and rotary motions in one unit
- ✓ Absolute control over force/torque, position, acceleration and velocity
- ✓ Direct drive brushless servo motor
- ✓ Vacuum through shaft prevents dust accumulation

Part Number	Voltage [DC]	Size: LxWxH [mm]	Stroke [mm]	Peak Force [N]	Continuous Force [N]	Force Constant [N/A]	Maximum Current [Amp]	Moving Mass [kg]	Weight [kg]	Peak Torque* [Nm]	Rotary type	Rotary Encoder Resolution	Velocity* [rpm]
CBR100-050-35-15	48	101.5x360	50	85	34	22	4	1.6	7.2	3.9	7.67:1	2K	300
CBR100-100-35-12	48	101.5x400	100	85	34	22	4	1.7	8.5	3.9	7.67:1	2K	300
CBR100-150-35-12	48	101.5x450	150	85	34	22	4	1.8	9	3.9	7.67:1	2K	300
LBR40-050-35-3	48	335x160x40	50	100	40	40	2.5	0.9	7.2	0.45	direct	2K	2100
LCR13-025-55-2	24	155x75x13	25	7	2.8	2.5	3	0.11	0.43	0.047	direct	24K	1K
LCR13-035-15-6	24	180x75x13	35	14	5.6	9.4	1.5	0.15	0.55	0.047	direct	24K	1K
LCR13-050-15-6	24	210x75x13	50	14	5.6	9.4	1.5	0.155	0.62	0.047	direct	24K	1K
LCR16-025-55-2	24	155x75x16	25	7	2.5	2.5	3	0.11	0.5	0.047	direct	24K	1K
LCR16-035-15-6	24	180x75x16	35	14	5.6	9.4	1.5	0.15	0.65	0.047	direct	24K	1K
LCR16-050-15-6	24	210x75x16	50	14	5.6	9.4	1.5	0.155	0.75	0.047	direct	24K	1K
LCR20-025-75-2	48	155x75x20	25	25	10	7	3.6	0.095	0.65	0.047	direct	24K	1K

NOTE: For any SMAC Moving Coil Actuators, the maximum recommended continuous duty current is 600mA supplied to the actuator over a 1 second period. For anything beyond this in terms of current draw or time please consult the factory. We manufacture actuators to suit our customers' requirements. Please call us if you do not find the right actuator in this list.



CBR100



LBR40

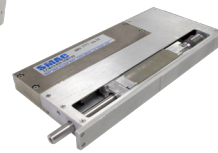

LCR13

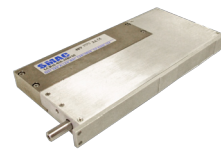

LCR16

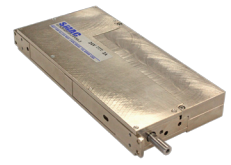

LCR20

Options & Modifications (Consult factory for availability)

Linear encoder resolutions	-----	5µm standard. 1µm optional.
Shaft ends	-----	Male, Female, Blank and Custom (check availability of custom option).
Return spring	-----	Prevents the shaft from dropping during vertical operation when power is cut.
Vacuum	-----	For pick and place applications.
Extended nose bushing	-----	For tighter shaft run-out and higher side load onto the shaft.
Increase of force & acceleration	-----	48 volt coil and double coil options are available for some units with 24 volt single coil.
Increase of torque/gear ratio	-----	Alternative geared motors are available for some units.
Rotary encoder resolution	-----	Consult factory for higher resolution.
Increase of force accuracy/lifetime	-----	Low-friction linear guide/extra-long preload linear guide.
M12 connector	-----	Option available with CBR series

LINEAR ROTARY ACTUATORS | LAR SERIES

The precision Z-theta motion within one small actuator, providing a convenient pick, orient and place.



- ✓ Soft-Land™ function and precise force/torque control
- ✓ Precision positioning
- ✓ Vacuum built-in through the shaft

Part Number	Voltage [DC]	Size: LxWxH [mm]	Stroke [mm]	Peak Force [N]	Continuous Force [N]	Force Constant [N/A]	Maximum Current [Amp]	Moving Mass [kg]	Weight [kg]	Peak Torque* [Nm]	Rotary Type	Rotary Encoder Resolution	Velocity* [rpm]
LAR31-030-55-1	24	140x80x34.7	30	11	4.4	7	1.5	0.19	0.84	0.06		40960	2000
LAR31-050-15-6	24	78.8x175x36.4	50	20	8	8.5	3.5	0.25	1	0.06		40960	2000
LAR35-025-55-1	24	190x90x35	25	12	4.8	7.5	1.6	0.32	1.55	0.085	direct	20K	75 - 5000
LAR35-050-55-1	24	190x90x35	50	10	4	7	1.6	0.29	1.4	0.085		20K	500 - 5000
LAR51-058-35-6	48	180x95.6x54	58	41	16.4	11.5	6	0.35	2.1	0.14		40960	2000
LAR55-050-55-1	24	250x110x55	50	25	10	19	1.6	0.5	3.1	0.2 - 2.5		2K - 28K	500 - 5000
LAR55-050-75-1	48	250x110x55	50	40	16	27	1.8	0.31	2.8	0.2 - 2.5		2K - 28K	500 - 5000
LAR55-100-55-1	24	250x110x55	100	16	6.4	13	1.6	0.5	3.85	0.2 - 2.5		2K - 28K	500 - 5000
LAR55-100-75-1	48	250x110x55	100	25	10	13	2	0.5	3.85	0.2 - 2.5	direct or gear box	2K - 28K	500 - 5000
LAR95-015-75-1	48	304x115x90	15	84	33	53	1.7	0.9	3.5	0.2 - 4.5		2K - 132K	75 - 5000
LAR95-050-75-1	48	304x115x90	50	65	26	41	1.7	0.93	4.2	0.2 - 4.5		2K	75 - 5000
LAR300-050-75-2	48	284x160x85	50	202	80	86	3	1	9.5	0.2 - 4.5		2K - 132K	75 - 5000
LAR300-100-75-1	48	291x160x85	100	80	32	43	4	1.69	10.7	0.2 - 4.5		2K - 132K	75 - 5000

NOTE: For any SMAC Moving Coil Actuators, the maximum recommended continuous duty current is 600mA supplied to the actuator over a 1 second period. For anything beyond this in terms of current draw or time please consult the factory. We manufacture actuators to suit our customers' requirements. Please call us if you do not find the right actuator in this list.



LAR31

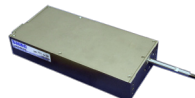

LAR35

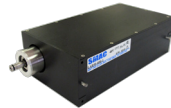

LAR51

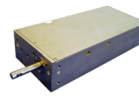

LAR55



LAR95



LAR300

Options & Modifications (Consult factory for availability)

- Linear encoder resolutions ----- 5µm standard. 1µm and 0.1µm optional for most units. Consult factory for availability.
- Shaft ends ----- Male, Female, Blank and Custom (check availability of custom option).
- Return spring ----- Prevents the shaft from dropping during vertical operation when power is cut.
- Vacuum ----- For pick and place applications.
- Extended nose bushing ----- For tighter shaft run-out and higher side load onto the shaft.
- Increase of force & acceleration ----- 48 volt coil and double coil options are available for some units with 24 volt single coil.
- Increase of torque/gear ratio ----- Alternative geared motors are available for some units.
- Rotary encoder resolution ----- Consult factory for higher resolution.
- Increase of force accuracy/lifetime ----- Low-friction linear guide/extra-long preload linear guide.

*Peak Torque and Velocity can vary based on your specific application.

LINEAR SLIDES | LCS SERIES

The LCS is designed based on the LCA series with stroke up to 250mm, and peak force up to 90N.



- ✓ High/low speed and precise positioning with high repeatability
- ✓ Ideal for parts feeding, scanning, testing
- ✓ Soft-Land™ capability

Part Number	Voltage [DC]	Size: LxWxH [mm]	Stroke [mm]	Peak Force [N]	Continuous Force [N]	Force Constant [N/A]	Maximum Current [Amp]	Moving Mass [kg]	Weight [kg]
LCS8-010-55-2	24	95x50x8	10	4	(*)	3.2	1.7	0.025	0.16
LCS8-025-15-3	24	110x50x8	25	2.6	(*)	2.2	1.3	0.025	0.17
LCS8-050-15-3	24	135x50x8	50	2.6	(*)	2.2	1.3	0.025	0.21
LCS25-010-55-1	24	70x55x25	10	8	3	6	1.5	0.04	0.27
LCS25-010-55-2	24	130x60x25	10	16	6	5.5	3	0.085	0.45
LCS25-010-75-1	48	70x55x25	10	12	4.8	8	1.5	0.04	0.27
LCS25-010-75-2	48	130x60x25	10	22	8	8	3	0.085	0.45
LCS25-025-15-6	24	130x60x25	25	15	7	13	1.6	0.08	0.55
LCS25-025-35-6	48	130x60x25	25	20.5	8	14.5	1.6	0.08	0.55
LCS25-025-55-2	24	130x60x25	25	7.4	2.9	2.5	3	0.08	0.55
LCS25-025-75-2	48	130x60x25	25	9.2	3.6	3	3	0.08	0.55
LCS25-050-15-6	24	155x60x25	50	15	7	13	1.6	0.08	0.616
LCS25-050-35-6	48	155x60x25	50	20.5	8.8	14.5	1.6	0.08	0.616
LCS25-100-15-6	24	205x60x25	100	15	7	13	1.6	0.08	0.808
LCS25-100-35-6	48	205x60x25	100	20.5	8.8	14.5	1.6	0.08	0.808
LCS25-150-15-6	24	258x60x25	150	15	7	13	1.6	0.08	*
LCS25-150-35-6	48	258x60x25	150	20.5	8.8	14.5	1.6	0.08	*
LCS25-200-15-6	24	310x60x25	200	15	7	13	1.6	0.08	1.183
LCS25-200-35-6	48	310x60x25	200	20.5	8.8	14.5	1.6	0.08	1.183
LCS50-025-75-1	48	125x100x50	25	50	20	40	1.5	0.296	2.118
LCS50-050-35-6	48	250x115x50	50	90	20	67	1.7	0.608	*
LCS50-050-75-1	48	125x100x50	50	45	18	30	1.6	0.33	2.57
LCS50-050-75-2	48	215x100x50	50	85	34	30	3	0.465	4.34
LCS50-100-35-6	48	300x115x50	100	90	36	67	1.7	0.885	5.6
LCS50-150-35-6	48	350x115x50	150	90	36	67	1.7	0.825	8
LCS50-250-35-6	48	450x115x50	250	90	36	67	1.7	0.885	14

NOTE: For any SMAC Moving Coil Actuators, the maximum recommended continuous duty current is 600mA supplied to the actuator over a 1 second period. For anything beyond this in terms of current draw or time please consult the factory. We manufacture actuators to suit our customers' requirements. Please call us if you do not find the right actuator in this list. (*)Consult factory



LCS8



LCS25

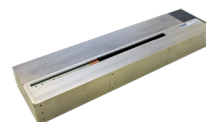

LCS50

Options & Modifications (Consult factory for availability)

- Linear encoder resolutions ----- LCS series: 5µm standard, 1µm optional
- Return spring ----- Prevents the shaft from dropping during vertical operation when power is cut.
- Increase of force & acceleration ----- 48 volt coil and double coil options are available for some units with 24 volt single coil.
- Increase of force accuracy/lifetime -- Low-friction linear guide/extra-long preload linear guide.

LINEAR SLIDES | LBS/SLA SERIES

LINEAR SLIDES

LINEAR SLIDES

The SLA incorporates precision cross roller guides with anti-creep protection for increased stiffness and lower friction.

The LBS with compact design provides quiet, efficient, and cost effective linear motion.



- ✓ Ideal for precision movements/scanning
- ✓ Encoder resolution down to 50 nm with the SLA
- ✓ Compact size

Part Number	Voltage [DC]	Size: LxWxH [mm]	Stroke [mm]	Peak Force [N]	Continuous Force [N]	Force Constant [N/A]	Maximum Current [Amp]	Moving Mass [kg]	Weight [kg]
LBS17-005-52-2	24	70x35x17	5	13.5	5.4	9.6	3	0.028	0.22
SLA10-005-55-1	24	50x50x10	5	2.2	(*)	1.5	1.5	0.02	0.08
SLA10-010-55-1	24	61x50x10	10	2.1	(*)	1.6	1.3	0.03	0.11
SLA25-010-55-2	24	72.5x40x25	10	4	(*)	2.7	1.5	0.05	0.203

NOTE: For any SMAC Moving Coil Actuators, the maximum recommended continuous duty current is 600mA supplied to the actuator over a 1 second period. For anything beyond this in terms of current draw or time please consult the factory. We manufacture actuators to suit our customers' requirements. Please call us if you do not find the right actuator in this list. (*)Consult factory



LBS17

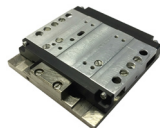

SLA10



SLA25

Options & Modifications (Consult factory for availability)

- Linear encoder resolutions ----- LBS series: 5µm standard, 1µm optional. SLA series: 5µm standard. 1µm, 0.1µm, and 0.05µm optional.
- Return spring ----- Prevents the shaft from dropping during vertical operation when power is cut.
- Increase of force & acceleration ----- 48 volt coil and double coil options are available for some units with 24 volt single coil.
- Increase of force accuracy/lifetime -- Low-friction linear guide/extra-long preload linear guide.

LINEAR SLIDES | LAS SERIES

The LAS series is designed based on the LAL series. Stroke up to 150mm, peak force up to approx. 200N.



- ✓ Soft-Land™ capability and precise force control
- ✓ Ideal for precision positioning and handling fragile material/components

Part Number	Voltage [DC]	Size: LxWxH [mm]	Stroke [mm]	Peak Force [N]	Continuous Force [N]	Force Constant [N/A]	Max Current [Amp]	Moving Mass [kg]	Weight [kg]
LAS35-025-55-2	24	135x90x35	25	31.5	12.6	15.5	2.9	0.19	1.06
LAS35-025-75-1	48	150x90x35	25	18	7	10	1.3	0.15	0.95
LAS35-050-55-1	24	135x90x35	50	10	4	7	1.6	0.13	1.1
LAS35-050-75-1	48	135x90x35	50	12.5	5	10	1.3	0.13	1.1
LAS35-100-55-1	24	135x90x35	100	6	2.4	3.5	1.6	0.13	1.7
LAS35-100-75-1	48	135x90x35	100	7.5	3	5	1.6	0.1	1.3
LAS55-050-55-1	24	250x110x55	50	25	10	19	1.3	0.3	3
LAS55-050-75-1	48	250x110x55	50	40	16	24.5	1.8	0.31	3
LAS55-100-55-1	24	250x110x55	100	16	6.4	13	1.3	0.3	3.8
LAS55-100-75-1	48	250x110x55	100	25	10	19	1.8	0.31	3.8
LAS55-150-55-1	24	250x110x55	150	13	5	10	1.3	0.4	4.5
LAS55-150-75-1	48	250x110x55	150	19.5	8	13	1.8	0.31	4.58
LAS95-015-75-1	48	90x70x95	15	84	33	53	1.7	0.25	2.1
LAS95-015-75-2	48	147x95x70	15	185	74	58	3.2	0.5	4
LAS95-025-75-2	48	179x70x95	25	162	65	52	3.1	0.5	3.78
LAS95-050-75-1	48	147x70x95	50	65	26	41	1.7	0.48	3.6
LAS300-050-75-2	48	210x85x120	50	202	80	86	3	0.8	8.8

NOTE: For any SMAC Moving Coil Actuators, the maximum recommended continuous duty current is 600mA supplied to the actuator over a 1 second period. For anything beyond this in terms of current draw or time please consult the factory. We manufacture actuators to suit our customers' requirements. Please call us if you do not find the right actuator in this list.



LAS35



LAS55



LAS95

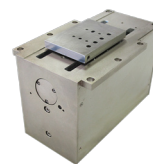

LAS300

Options & Modifications (Consult factory for availability)

- Linear encoder resolutions ----- 5µm standard. 1µm and 0.1µm optional for most units. Consult factory for availability.
- Return spring ----- Prevents the shaft from dropping during vertical operation when power is cut.
- Increase of force & acceleration ----- 48 volt coil and double coil options are available for some units with 24 volt single coil.
- Increase of force accuracy/lifetime ----- Low-friction linear guide/extra-long preload linear guide.

The MGR, GRP and LXY have the advantage of independent control of the velocity, acceleration, positioning and force of each axis. This gives you a flexible and accurate tool.



- ✓ Precise force control, measuring and positioning
- ✓ Soft-Land™ capability for sensing product location and dimensions
- ✓ No backlash, no cogging

Part Number	Voltage [DC]	Size: LxWxH [mm]	Stroke per Axis [mm]	Axis 1				Axis 2				Maximum Current [Amp]	Weight [kg]	Maximum Opening
				Peak Force [N]	Continuous Force [N]	Force Constant [N/A]	Moving Mass [kg]	Peak Force [N]	Continuous Force [N]	Force Constant [N/A]	Moving Mass [kg]			
MGR7-010-51-1	24	55x47.5x24	5	3.8	(*)	10.9	0.009	3.8	(*)	10.9	0.009	0.35	0.17	10
GRP20-010-51-1	24	80x90x23	5	8	3.2	5.5	0.065	8	3.2	5.5	0.065	1.8	0.5	10
GRP35-030-55-1	24	93x110x38	15	25	10	17	0.1	25	10	17	0.1	1.5	1.5	30
GRP35-030-75-1	48	93x110x38	15	26	10	13	0.1	26	10	13	0.1	1.9	1.5	30
GRP50-030-55-1	24	90x125x55	15	35	14	23	0.15	35	14	23	0.15	1.5	2.1	30
GRP50-030-75-1	48	90x125x55	15	45	18	23.6	0.15	45	18	23.6	0.15	1.9	2.1	30
LXY15-015-75-1	48	111x112x86	15	22	11	13	0.13	25	12	12	0.22	2.2	1.65	N/A
LXY25-025-75-2	48	125x125x65	25	42	17	14	0.19	42	17	14	1.5	3	3.2	N/A

NOTE: For any SMAC Moving Coil Actuators, the maximum recommended continuous duty current is 600mA supplied to the actuator over a 1 second period. For anything beyond this in terms of current draw or time please consult the factory. We manufacture actuators to suit our customers' requirements. Please call us if you do not find the right actuator in this list. (*)Consult factory



MGR7



GRP20



GRP35



GRP50

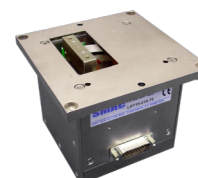

LXY15



LXY25

Options & Modifications (Consult factory for availability)

- Linear encoder resolutions ----- 5µm standard, 1µm and 0.1µm optional for most units. Consult factory for availability.
MGR7: 1µm standard.
GRP20: 1µm standard and 0.1µm optional.
GRP35 and GRP50: 5µm standard, 1µm and 0.1µm optional.
- Increase of force & acceleration ----- 48 volt coil and double coil options are available for some units with 24 volt single coil.
- Increase of force accuracy/lifetime ----- Low-friction linear guide/extra-long preload linear guide.

Multi-Axis Orientation Options

SMAC offers versatile and flexible multi-axis solutions. The systems with SMAC multi-axis solutions deliver the capability to learn and follow a 3D contour or motion path with a high degree of speed, precision, accuracy, and repeatability. All combinations of SMAC actuators can be used: linear, linear slide, linear/rotary and XY stage axis.

SMAC multi-axis solutions feature and utilize linear/circular interpolation and electronic gearing which enables a constant speed while following the chosen XYZ axis contour. Ideal applications are measuring and testing (i.e., quality control), pick and place, deposition, machining, scoring and cutting, to name a few.

Multi-axis systems with SMAC actuators enable total programmability of speed, position and force, all at the same time, with an exceptional degree of accuracy and repeatability. These multi-axis systems offer a wide range of solutions with a number of highly flexible control interfaces. When system integrators consider SMAC actuators, many new opportunities are now available with airless, clean-room capable features. These are some examples of how SMAC actuators have been combined.

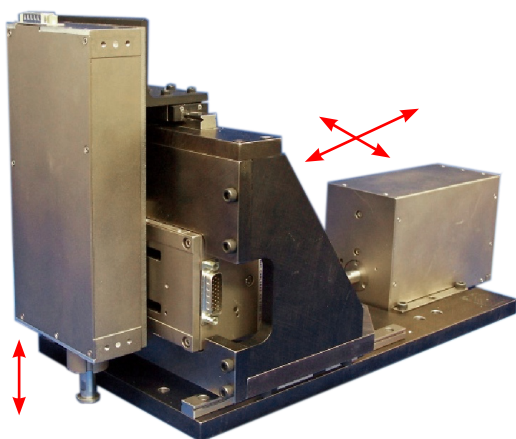

Multi-Axis LAL35, LAL95 and LAS95 (3 Axes)

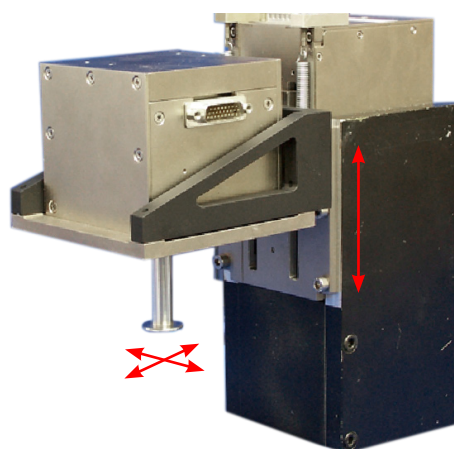

Multi-Axis LXY15 and LAS95 (3 Axes)

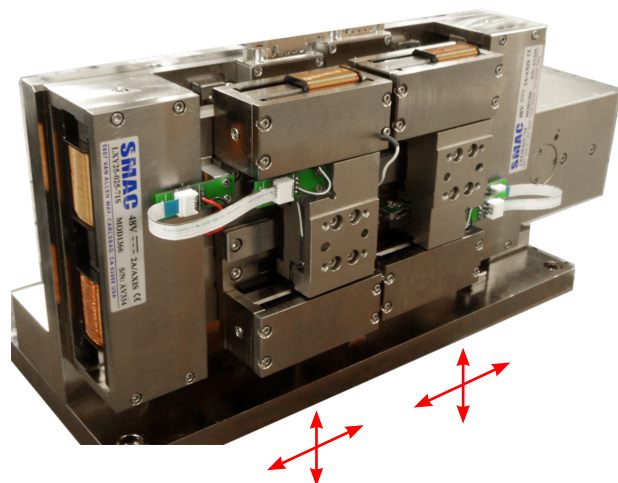

Multi-Axis, x2) LXY25 and x1) LAS95 (5 Axes)

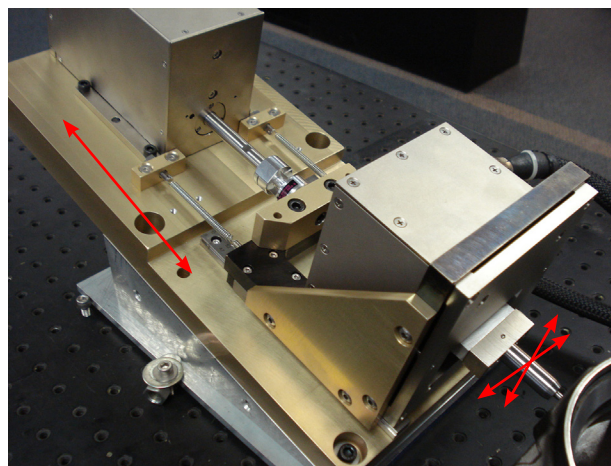

Multi-Axis LXY15 and LAL95 (3 Axes)

Controllers and Amplifiers

SMAC supplies a range of single and multi-axis controllers as well as stand-alone amplifiers. Complimentary standard programming software is available on the SMAC website, <http://www.smac-mca.com/products/controllers>. SMAC supports connectivity with ethernet fieldbuses like EtherCAT and Ethernet /IP on certain models. Please contact us for more information.



GUI

VLC-M1

"Very Low Cost" single axis servo motor controller/driver, designed and manufactured by SMAC. 3-Phase Brushless, DC Brushed, DC linear actuator.

Mode: Position/Velocity/Force/Soft-Land

8-50VDC
 3.5 Arms continuous, 6.5 Arms peak
 1 analog input, 0-10V range, 12 bit
 2 PLC level opto isolated digital outputs 5 to 24V
 2 SSR (solid state relay) isolated digital inputs 5-24V
 RS232



GUI

VLCI-R1

"Very Low Cost" single axis servo motor controller/driver, designed and manufactured by SMAC. 3-Phase Brushless, DC Brushed, DC linear actuator. Can be integrated into actuators.

Mode: Position/Velocity/Force/Soft-Land

8-48VDC
 3.5 Arms cont., 6.5 Arms peak
 2 differential analog inputs, 12 bit
 4 PLC level opto isolated digital outputs 5 to 24V
 4 SSR (solid state relay) isolated digital inputs 5-24V
 STO (Safe Torque Off)
 2 STO Opto-Isolated Inputs 5-24V
 1 STO Opto-Isolated Feedback Output 5-24V
 Analog Outputs 1 Channel, 0 to 10V with 12-Bit Resolution
 RS232



GUI

VLCC-25-07

"Very Low Cost" two-axis servo motor controller/driver, designed and manufactured by SMAC. 3-Phase Brushless, DC Brushed, DC linear actuator.

Mode: Position/Velocity/Force/Soft-Land

8-48VDC
 6 Arms cont., 7.8 Arms peak
 10 Arms cont., 13 Arms peak output optional (consult factory)
 4 PLC level opto isolated digital outputs 5 to 24V
 4 SSR (solid state relay) isolated digital inputs 5-24V
 2 Opto-Isolated Coarse Home Inputs
 2 STO Opto-Isolated Digital Inputs, 5V to 24V Max
 1 STO Opto-Isolated Feedback Output 5-24V
 2 12-Bit Differential Analog Inputs, 0 to +/- 10V Range
 3 12-Bit Analog Inputs, 0V to 10V Range
 2 12-Bit Analog Outputs, 0V to 10V Range (0V to 5V Optional)

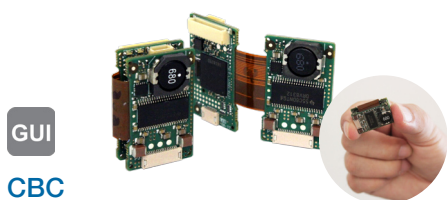

GUI

CBC

Single-axis miniature controller with a built-in amplifier. Single-phase/brushed and 3-phase/brushless motors/actuators.

Mode: Position/Velocity/Force/Soft-Land

8-48VDC
 3 Arms cont., 6 Arms peak
 2 PLC level (24V) non-isolated digital inputs
 2 Open drain digital outputs*
 1 single-ended analog input, 0-5VDC, 10-bit
 1ms position loop sampling rate
 Built-in configurable I²T function to prevent overheating
 RS232, CANopen

* Consult factory for opto-isolated I/O options.



CBC-I-3/6-C

Single-axis miniature controller with a built-in amplifier. Single-phase/brushed and 3-phase/brushless motor/actuators

Mode: Position/Velocity/Force/Soft-Land

8-48VDC
 3 Arms cont., 6 Arms peak
 4 PLC level opto isolated digital outputs 5-24V
 4 SSR (solid state relay) isolated digital inputs 5-24V
 1 single-ended analog input, 0-5Vdc, 10-bit
 2 STO opto-isolated inputs 5-24V
 1 STO opto-isolated feedback output (optional)
 1ms position loop sampling rate
 Built-in configurable I²T function to prevent overheating
 RS232, CANopen



GUI

CBC-EIP / CBC-ECT

Industrial EtherNet-ready servo drives. Integrated single-axis servo motor controller/driver with Ethernet/IP (CBC-EIP) or EtherCAT (CBC-ECT) connectivity.

Mode: Position/Velocity/Force/Soft-Land

8-48VDC
 3 Arms cont., 6 Arms peak
 4 PLC level opto isolated digital outputs 5 to 24V
 4 SSR (solid state relay) isolated digital inputs 5-24V
 1 5V output supply for powering external circuitry
 1 0-5V single ended analog input
 2 STO inputs, isolated inputs 5-24V
 1 STO feedback output (optional) 5-24V
 External diagnostics capability
 Abnormal operation detection
 RS232, Ethernet/IP (2-port) or EtherCAT (2-port)

GUI



LCC-10 (LCC-11)

Single-axis controller with a built-in amplifier. Single-phase/brushed and 3-phase/brushless motors/actuators.

Mode: Position/Velocity/Force

24-48VDC
 2 Arms cont., 4 Arms peak
 4 TTL compatible non-isolated digital inputs/outputs*
 1 single-ended analog input, 0-5VDC, 12-bit
 1 differential analog input, +/-10VDC, 12-bit
 1 analog output.
 LCC-10: 0-5VDC, 10-bit.
 LCC-11: 0-10VDC, 16-bit.
 1ms position loop sampling rate
 Built-in configurable I²T function to prevent overheating
 Can be run as amplifier only, velocity drive and Step & Direction Emulator
 RS232, CANopen

GUI



LAC-1/LAC-1C/LAC-1D

Single-axis controller with a built-in amplifier. Single-phase/brushed motors/actuators.

Mode: Position/Velocity/Force

12-48VDC
 3 Arms cont., 6 Arms peak
 8 TTL compatible non-isolated digital inputs/outputs*
 3 analog inputs. LAC-1/LAC1-C: 0-5VDC and 10-bit.
 LAC-1D: programmable voltage range and 16-bit.
 Max. position loop sampling rate. LAC-1: 0.2ms. LAC-1C/LAC1-D: 0.1ms.
 RS232

GUI



LAC-25

2-axis controller with built-in amplifiers. Independent or coordinated 2-axis motion. Single-phase/brushed motors/actuators (axis 1 and 2)

Mode: Position/Velocity/Force/Gearing

12-48VDC
 3 Arms cont./axis, 6 Arms peak/axis
 4 SSR (solid state relay) isolated digital inputs 5-24V
 4 PLC level opto isolated digital outputs 5 to 24V
 Max. position loop sampling rate of 0.1ms per axis
 RS232

MC-2



CANopen-based master controller enabling multi-axis (up to 127) motion coordination of SMAC's LCC/CBC controllers. Additionally, the master controller can act as a gateway to a PLC through Ethernet/IP.



LAD-1

Smart Driver for single-axis stepper input to servo output
 24-48VDC
 RS232

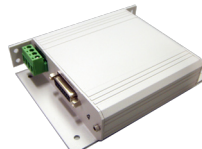

LAA-5

Single-axis PWM Amplifier
 24-48VDC
 3 Arms cont., 6 Arms peak
 +/- 10 Volt command input
 Single-axis PWM Amplifier

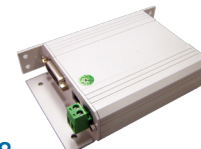

MIOE-8/8

Expansion I/O module for LAC-1, LAC-25 and LAC-45
 24-48VDC
 8 opto-isolated input/output

Graphical User Interface (GUI)

SMAC Graphical User Interface provides a simple and straightforward way to quickly configure motion parameters of a variety of SMAC single/dual axis actuators and controllers. Pre-installed, user configurable application-based GUIs are also available.

- Little to no programming experience required
- Menu-driven, Windows based, easy setup
- Pre-programmed with application-specific features
- Real time analysis
- Data and graphical feedback tools
- Built-in tutorial and help features

LCC Control Center

Achieve high level programming with no programming experience, monitoring and logging of parameters, fine-tuning of control parameters for LCC and CBC controller.

LAC-X Editor

Easy setup and tuning of control parameters for LAC-1 and LAC-25.

Thread Check Center: TCC

User configurable Thread-Checking applications. Fully automated 100% inspection of internal & external threads. Verification of counter bore height, thread pitch, oversized/undersized threads, cross thread and shallow thread, etc.

Capping Control Center: CCC

User configurable threaded bottle/container capping applications. Detect and report no/obstructed cap. Adjust force and torque, show the different quality check capabilities such as cap height, torque limit, force required to press-in, and even check the clicks on child proof caps.

Gauging Control Center: GCC

User configurable gauging applications. Provide real time plot of measured values in relation to limits. The user may save a .csv or image file of the measured values or graph area respectively for data logging.

Ejection Control Center: ECC

User configurable Ejection applications. Select and program between 4 types of ejection sequence including soft eject, rapid eject etc. Control velocity for ejection based on customer cycle time requirements. Adjust force to eject based on the weight/mass of the object to eject. Manipulate position to park the actuator based on the program sequence.

Leak Test Center: LTC

User configurable Leak testing applications: Select and program between two types of leak testing procedure(Velocity and Force). Unique capability of SMAC actuator to soft land on the object and applying force can be programmed using this GUI. Precise monitoring of displacement of the bottle/container/ or any testing sample during leak testing. Adjust the force to be applied on the test object using this software.

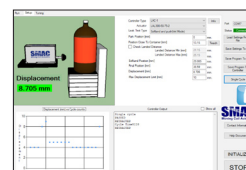
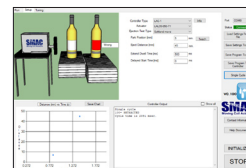
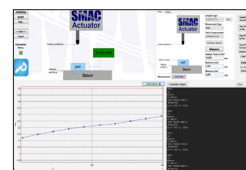
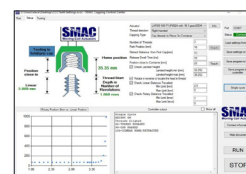
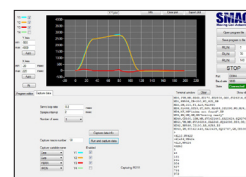
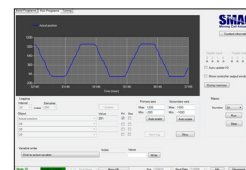

Why Use SMAC Cables?

SMAC actuators are used in numerous high speed, high cycle applications and are guaranteed for millions of cycles. For this reason, it is imperative that the cables used to connect with our actuators are capable of similar arduous duty cycles and life span. Only cables manufactured by SMAC can be guaranteed to meet the rigorous standards required during use. Many years of experience has taught us that cheaper third party cables simply are not up to the task required. They are, in fact, one the most common causes of technical problems experienced by our customers.

Models	Single Axis Controller		Dual Axis Controller		Amplifier	Smart Driver
Actuator	LAC-1 / VLC-M1	LCC-10(11)	VLC-25-07/13	LAC-25	LAA-5	LAD-1
CAL*	CAH-LOD26-03	CAH-LOD26-03			CAH-LAD26-03	CAH-LSD26-03
2x CAL*				CAH-LTD-03		
CBL*	CAH-LOD26-03	CAH-LOD26-03			CAH-LAD26-03	CAH-LSD26-03
2x CBL*				CAH-LTD-03		
CBR			MAH-RTD026-03			
CTL Single Phase	CAH-LOD26-03	CAH-LOD26-03			CAH-LAD26-03	CAH-LSD26-03
LBL Multi Phase		MAH-LOD26-03				
LCA(S) Single Phase	CAH-LOD26-03	CAH-LOD26-03			CAH-LAD26-03	CAH-LSD26-03
LCA (S)* Multi Phase		MAH-LOD26-03				
SLA10	CAH-LOD26-03 (with LAH-PT12-26)	CAH-LOD26-03 (with LAH-PT12-26)			CAH-LAD26-03 (with LAH-PT12-26)	CAH-LSD26-03 (with LAH-PT12-26)
SLA25*	CAH-LOD26-03	CAH-LOD26-03			CAH-LAD26-03	CAH-LSD26-03
LAL35/LAL95	LAH-LOD26-03	LAH-LOD26-03			LAH-LAD26-03	LAH-LSD26-03
LAL55/LAL300/LAL500	LAH-LOD-03	LAH-LOD-03			LAH-LAD-03	LAH-LSD-03
LAR35	LAH-RED26-03 (with 2x LAC-1s)	LAH-RED26-03 (with 2x LCC-10s)		LAH-RTD26-03	LAH-RAD26-03	LAH-RSD26-03
LAR31-030		MAH-RED226-03 (with 2x LCC-10s)	MAH-RTD226-03			
LAR31-050		MAH-RED026-03 (with 2x LCC-10s)				
LAR55/LAR95/LAR300	LAH-RED-03 (with 2x LAC-1s)	LAH-RED-03 (with 2x LCC-10s)		LAH-RTD-03	LAH-RAD-03	LAH-RSD-03
LBR			MAH-RTD026-03			
LCR13/LCR16/LCR20 Under 25mm stroke (Linear single pole, rotary multi pole)		MAH-RED226-03 (with 2x LCC-10s)	MAH-RTD226-03			
LCR13/LCR16/LCR20 35mm stroke and above (Both linear and rotary multi pole)		MAH-RED026-03 (with 2x LCC-10s)				
2x LAL35/LAL95				LAH-LTD26-03		
2x LAL55/LAL300/ LAL500				LAH-LTD-03		
MGR	CAH-RED26-03 (with 2x LAC-1)	CAH-RED26-03 (with 2x LCC-10)		LAH-RTD26-03		
GRP20/GRP35/ GRP50**	LAH-RED26-03	LAH-RED26-03		LAH-RTD26-03		
LXY15/LXY25				LAH-GRP-03		

* No cable required for flying lead option. ** Old type of GRP50 requires LAH-GRP26-03 cable.

Options & Modifications (Consult factory for availability)

Cable length ----- 3m standard, optional 10m length is available. Consult factory for other length.

Superflex ----- Suitable for robotic applications.

Non-SMAC controller connector ----- Consult factory for details.

SMAC Moving Coil Actuators

SYSTEM CONFIGURATION

Configuration with SMAC Controllers

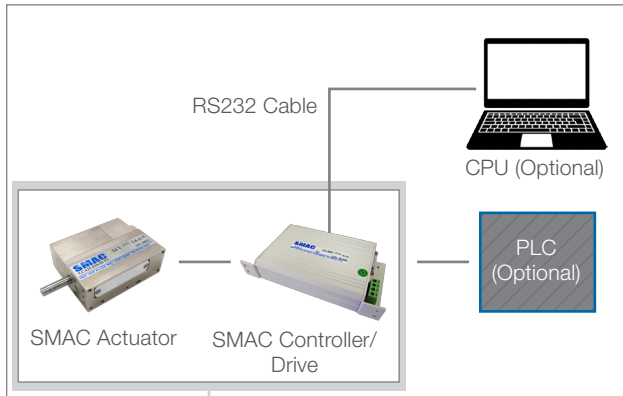

Configuration with Non-SMAC Controllers

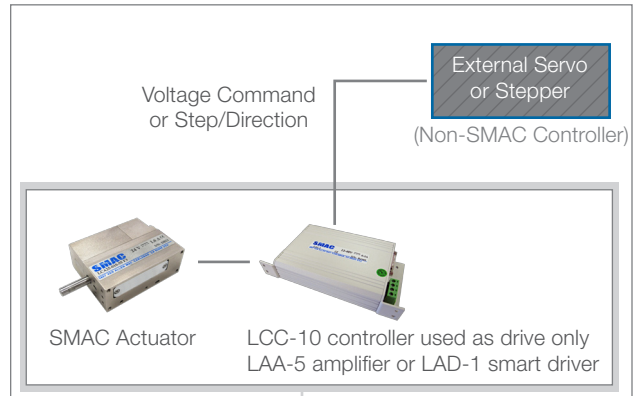

Configuration for Flying Lead Cable

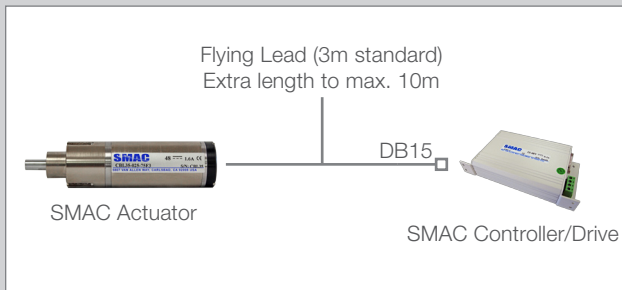

CAL, CBL, CTL, LCA, LCB, LBL, MGR and SLA series

Configuration for Pigtail Cable

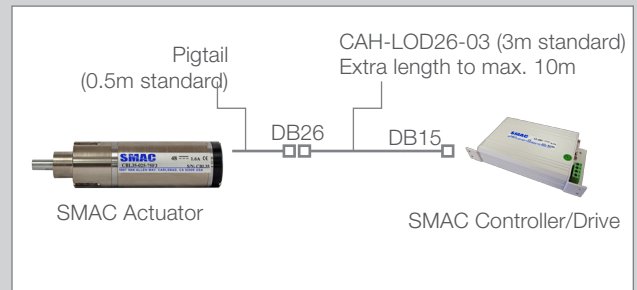

Configuration for SMAC Cable

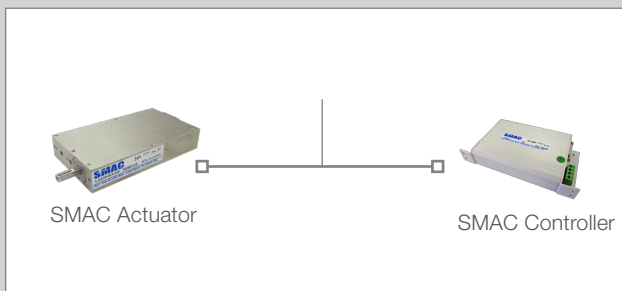

LAL(S), LAR, GRP and LXY series

Configuration with 2 Single Axis Controllers

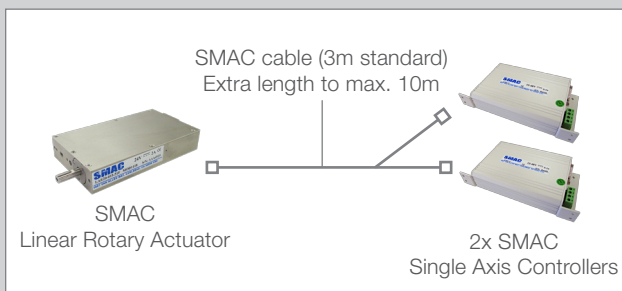

LAR and LCR series

Configuration with 1 Dual Axis Controller

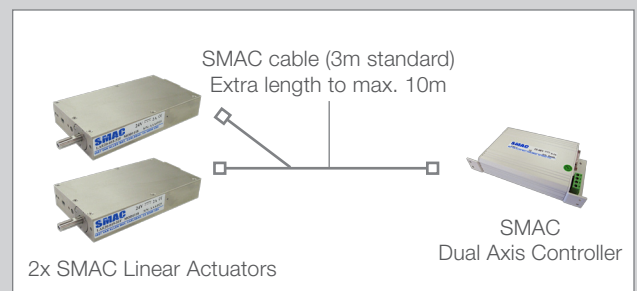

LAL(S) series

INSTALLATION GUIDE

Duty Cycle

For any SMAC Moving Coil Actuator, the maximum recommended continuous duty current is 600mA supplied to the actuator over a 1 second period. For anything beyond this in terms of current draw or time please consult the factory.

NOTE: Failure to observe this duty cycle recommendation may result in the actuator sustaining damage through overloading. Overloading will overheat the coil and may cause deformation or an impact on the magnet housing.

Continuous Force

Peak force applied for duration shorter than 0.4 sec. in one second interval. (force mode): 40% of peak force, continuous.

Force Mode

The specified current may be applied continuously to generate the desired force. However, the recommended continuous force limit should be set in the control program.

In vertical operation, the actuator rod will drop when power is cut off. The rod in a lowered position may be damaged by other moving parts in the machine. A return spring (optional feature) will keep the rod raised. A safety lock-out should be installed in the machine program to confirm the rod location before another interfering component can be moved.

SMAC actuators are equipped with these safety features:

- Index line/home position: used to monitor absolute position
- Breakaway shaft (optional)

Safety Considerations

Unintentional full force may be applied continuously under the following conditions:

- missed target position
- excessive friction
- equipment malfunction, i.e. jam

If left undetected, this can cause destruction of the coil in some units. A servo program should perform the following checks regularly:

- Re-home: to assure target position has not shifted beyond end of stroke
- Time-outs: to shut power down within 10 seconds of error detection
- Following Error Limits: software safety

Mounting

If the actuator is mounted vertically, the shaft drops down when the actuator is powerless. It is possible that other moving parts of the machine may damage the actuator at this position. A return spring would hold the actuator in an upper position when it is powerless.

A safety function in your machine should check the actuator's current position before other components may move into the working area of the actuator.

INDIVIDUAL MODIFICATION

Many of our standard actuators listed on previous pages are compatible with both add-on options and modifications. In addition to the standard vacuum and spring option SMAC can offer the following modifications subject to approval by the factory.

Linear Guide Options

Increased rigidity and side load tolerance can be gained by using a higher specification "wide guide". Additionally, in force sensitive applications we can fit a low friction guide.

Double Coil

Integrating an extra coil can enhance both force and acceleration.

Custom Nose-Bushing

An extended nose bushing with increased side load tolerance are available on many models. We can also offer scraper and wiper seals around the shaft to protect the bearings from excessive wear in harsh environments.

Custom Shafts

In addition to the standard male/female rod ends we can also offer options such as "breakaway" shafts and custom shaft diameters.

10µm T.I.R.

Total indicator run-out under 10µm is available on several linear/rotary models.

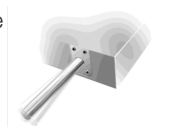

Rotary

Increased torque/gear ratio can be gained by using alternative geared motors or direct drive motors.

Higher rotary encoder resolutions are optional. Please consult factory for availability.

If a longer life rotary is required, then we can fit a brushless rotary motor.

Flying Lead

Instead of the standard chassis connector we can offer a flying lead option. The flying lead is standard for all the CA and LCA series actuators.

Cable Options

Whenever an SMAC actuator is mounted to any 3rd party device such as a gantry or multi-axis robot, SMAC strongly recommends that a superflex cable is used. Cable lengths with a standard of 3 meters up to a maximum of 10 meters can be offered.

SELECT YOUR ACTUATORS

Select Your Actuator

In order to select the correct actuator for your application, the following parameters should be known.

Machine Function: Space Available [mm]: x= y= z=	Mount Details: Mount surface: Axis side surface / Actuator side surface
Orientation: Horizontal / Vertical rod down / Vertical rod up	Environment: Debris / Dust / Vapor / Temperature / Harsh Cleaning Chemicals

Specifications	
Linear	Rotary
Stroke [mm]:	Degree of Rotation:
Max. Velocity:	Max. Rot. Velocity:
Min. Velocity:	Min. Rot. Velocity:
Max. Acceleration:	Max. Rot Acceleration:
Max Force [N]: Continuous force [N]:	Max Torque:
Force Resolution [N]:	Torque Resolution:
Force Repeatability [N]:	Torque Repeatability:
Encoder Resolution [µm]: 5 / 1 / 0.1 / other ()	Encoder Resolution:
Repeatability [µm]:	Repeatability:
Cycles/sec:	Cycles/sec:
Expected Cycle Life:	Expected Cycle Life:

Rod		
Moving part: Rod / Slide	Rod Length (Full Retract) [mm]:	Tip: Male / Female / Blank / Custom
Material requirement:	Vacuum through shaft: Yes / No	Thread of shaft: Standard / M ()

Special Features			
Plating:	Cable:	Spring:	Linear Guide:
Standard / Black anodized	Standard / Superflex	Full return / Counter balance	Standard / Long life

Controller or Amplifier			
Location:	Cable:	I/O:	Smart Driver:
Built-in / External at () m	Standard / Flying lead	Number and TTL / 24V	Yes / No

Payload		
Weight [gram]:	Size: (LxWxH)	Inertia:
Shape:	Relation to rod/slide: Fixed / Push only / Other	Remarks:

APPLICATIONS

Mechatronic SMAC electronic actuators are used widely in automotive, packaging, electronics, robotics, pharmaceutical, medical assembly, laser cutting, high speed scanning, glass cutting, dispensing, switch testing, spot welding, soldering, and measuring applications to name but a few. SMAC is constantly working on new and diverse applications with both OEMs and end-users across the world.

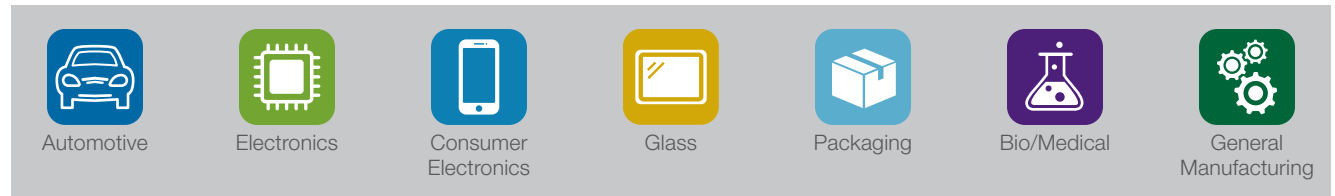

Pick & Place

The precision Z-theta motion within one small actuator, providing a convenient pick, orient and place. The unique Soft-Land function allows the unit to gently land on a delicate component with a controlled force, avoiding damage to the component. These characteristics make SMAC electric actuators ideal for assembling small, fragile components.

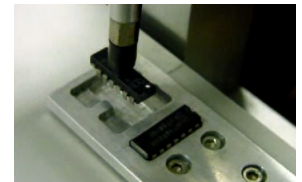

Switch Testing

In-line durability test. Measuring click point, force and displacement. Report force vs. position with SPC data collection. Life testing of components as well as measurement and QA reporting functions in one unit.

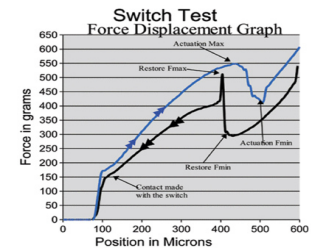

Touch Screen Testing

Quality check for touch screen, including zoom in and out, swiping motion, touch screen fatigue test. SMAC's Soft-Land procedure, programmable force, high speed and detailed feedback are essential in the testing.



100% Automated Thread Check

Fully automated 100% inspection and test of screw thread check for optimal quality assurance. The unique low-cost SMAC solution enables you to automatically check the following screw thread parameters: Oversize/undersized threads, cross threads, thread depth, no-threads, mis-located threads, thread pitch, and shallow/blocked hole.

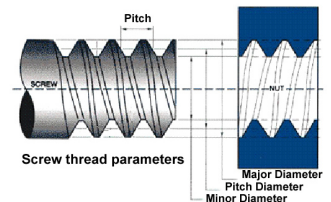

Measuring, Bore Gauging and Groove Inspection

100% measure and test inline production of small components for quality control. The SMAC actuator conducts multiple point gauging on parts externally and internally within a few seconds. It can run 24/7 and enables 100% data feedback and verification of each individual test on each individual part.

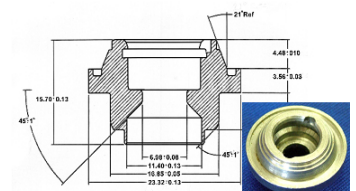

Tensioning with Precision Force Control



SMAC excels at force control which is key for tensioning materials such as car batteries. Force resolution of 10 grams maintained over the entire force range. Easily replaces low friction pneumatic cylinders that have inconsistent force throughput. Response time 10x better than our closest competitor.



Dispensing / Filling



SMAC actuators' repeatable positioning coupled with high speed allows you to more precisely and repeatedly control the dosing amount. SMAC actuators also allow for easy change over for different dosing requirements based upon the material and container size.



High Speed Pressure/Leak Detecting



SMAC actuator senses the surface of container/package, push with specific force and monitor the movement to determine pressure in container/package. This solution can be used for soft pouch packaging such as contact lens or single-served coffee "pods."



Rejecting, Diverting, and Multi-Lane Sorting



SMAC can reject or divert one container at line speeds over 1200 containers/ minute. Movement of container is smooth, fast, and gentle with unique Soft-Land™ feature. Container will not tip over because of force and velocity control.



Capping



SMAC linear rotary actuator rotates the cap while pushing down. Actuators can press with programmable force and provide torque feedback that informs when the cap has torqued out (or not) to ensure a quality operation. It shows the different quality check capabilities such as cap height, torque limit, force required to press in, and even check the clicks on child proof caps.



Assembly

Assembly requires both precise placement and precise low force control. SMAC linear rotary actuators perform pick, orient, and place movements in a single unit. Precise force control and Soft-Land™ capability preventing parts damage delivers a great advantage. Feedback of assembly positioning provides real time quality control information.



Smart Screwdriver

SMAC linear rotary actuators are an all in one solution. Fast approach, then find the surface with Soft-Land™ capability. Turn counter clock-wise, screw moves up, then drops as first thread found, then start rotating clock-wise. First a “snug” torque is applied, when there are a number of screws holding a part on the clamping surface, then a final torque is applied. Monitoring the torque and pitch verification. Good, shallow, cross/no-threads, and the precision of the thread are detected through linear position feedback.

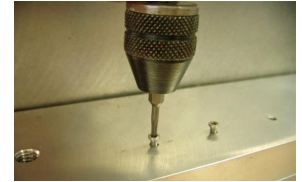

High Speed On-the-Fly Labeling

The label applicator (SMAC actuator) matches the speed of the conveyor as the product comes through. High cycle rate, energy efficient, and adjustable speed and height for the different kind of products. The Soft-Land™ capability allows the actuator to apply labels with controlled low force.

Scanning

A series of precise short movements with repeatability in micron or sub micron ranges used for moving lenses/cameras, wafer scanning, microscopy, cytometry, etc. SMAC actuators eliminate incremental errors that come with the use of open-loop actuators. SMAC's precision actuators are fully close-looped and provide extremely accurate position data and positioning capability with resolution as to five nanometers. Easy setup, compact, all-in-one package is ideal for integration to existing equipment and new developments.



Material Test

SMAC actuators can be programmed to develop a motion profile required. By measuring the force used to stretch/manipulate the material to the prescribed length, the gradual degradation of the material could be continuously monitored.

Glass Cutting / Scoring

Precision work in grinding, cutting, and polishing processes can be easily done by SMAC programmable actuator. Precise force control and the ability to track a surface with constant force throughout the stroke are important when handling brittle material. SMAC's unique Soft-Land function, the ability to apply as low force as 0.1N or less, and move with a set force while bevelling or cutting is something SMAC can easily do.

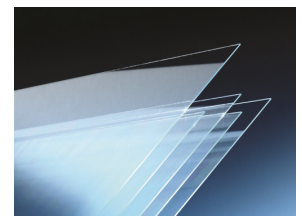

The SMAC 12 Month Product Guarantee

SMAC Corporation designs and manufactures advanced electric actuators. All SMAC actuators are quality products specifically designed and built for long service. Therefore, all actuators appearing in this catalog are guaranteed for a period of twelve months from the original date of shipment from our factory.

The guarantee conditions are effective when a SMAC actuator is connected via a SMAC or SMAC approved cable/connector and controlled by either a SMAC or SMAC approved controller. If a customer wishes to use a cable/connector or controller which is neither manufactured by, nor qualified/approved by SMAC, SMAC offers a test and qualification service to the customer. Once tested and approved the standard SMAC guarantee applies. Please contact your local SMAC branch for details. This guarantee is limited to a one-time replacement or rebuilding of any actuator which should fail to operate properly.

Actuators must be returned with transportation prepaid and received at our factory within the guarantee period. They will be returned to the customer at the expense of SMAC.

No claims for labor, material, time, damage or transportation are allowable. Actuators damaged as a result of misapplication by the customer are excluded from this guarantee. The guarantee does not apply to loss or damage caused by fire, theft, riot, explosion, labor dispute, act of God or other causes beyond the control of SMAC. SMAC shall in no event be liable for remote, special or consequential damages, under the SMAC guarantee or under any implied warranty.

The above guarantee is our manner of extending the engineering and service resources of the SMAC organization to assure our customers long and continued satisfaction.

The SMAC Rebuild Program

Actuators no longer covered by the SMAC guarantee can be rebuilt under the SMAC rebuild program. Our continued research and development program extends the life of our actuators making them even more reliable under adverse operating conditions. Actuators returned under this program are completely disassembled, inspected and rebuilt to current operating standards wherever possible, tested and returned within a few days for a reasonable charge (typically 35% of standard list price). For 90 days from date of shipment from our factory, all rebuilt actuators carry the same guarantee as provided for new actuators.

SMAC products have been tested and found to be fully compliant with EN 50082-2 & EN 55011 Group 1, Class A.

Terms & Conditions of Sale

SMAC manufactures and sells actuators, controllers and cables. It has a standard warranty policy covering these products. SMAC does not offer integration services. These are the responsibility of SMAC distribution and their customers. This means SMAC takes no responsibility for software programming, mechanical designs and all other engineering involved in a project using SMAC devices. SMAC may, at its discretion, offer technical recommendations or suggestions to help its customer, the distributor, on a particular application. SMAC will only do this once a signed release of responsibility is received from its customer.

U.S. and world wide patents issued & applied for. SMAC improves its product line on a continuing basis. Specifications and mechanical dimensions are subject to change without notice. Please consult factory before proceeding with your design.

WORLDWIDE LOCATIONS

North & South America

SMAC Inc.

Corporate Headquarters & Factory

5807 Van Allen Way
Carlsbad, CA 92008

Tel: 760-929-7575

Fax: 760-929-7588

Email: info@smac-mca.com

Website: www.smac-mca.com

SMAC Western Region

Tel: +1 760-420-5381

Email: mferris@smac-mca.com

SMAC Northeast (NH)

Tel: 603-329-3158

Cell: 978-891-7341

Email: smaceast@tds.net

SMAC Midwest (MI)

Tel: +1 616-554-5672

Fax: +1 616-554-5762

Cell: +1 616-813-2990

Email: smacmidwest@tds.net

SMAC Midwest (OH)

Cell: +1 330-730-5149

Email: smacoh@tds.net

SMAC Midwest (IL)

Cell: +1 312-446-8643

Email: haidos@gmail.com

SMAC Midwest (IN)

Cell: +1 317-927-5699

Email: smacin@tds.net

SMAC Texas

Tel: +1 512-365-0151

Email: rick-hernandez@smac-mca.com

SMAC Mexico

Cell: +52 1-449-266-3984

Email: manuelr@smac-mca.com

Website: www.smac-mca.mx

Europe

SMAC Europe Ltd. (UK)

Tel: +44 (0)1293-520147

Email: info@smac-mca.co.uk

Website: www.smac-mca.co.uk

SMAC Italy / Spain / Portugal

Tel: +39 0382-921742

Cell: + 39 377-2862952

Email: roberto.bardoni@smac-mca.it

SMAC Germany

Email: centraleurope@smac-mca.com

Tel: +49 (0)176-20646866

Website: www.smac-mca.com

Asia

SMAC Japan

Tel: 81-(0)3-6408-5358

Fax: 81-(0)3-6408-5359

Email: smacjapan@smac-mca.co.jp

Website: www.smac-mca.co.jp

SMAC Taiwan

Tel: +886-2-2974-9732

Fax: +886-2-2974-3706

Email: sales@smac-mca.com.tw

SMAC South Korea

Tel: +82-70-8784-9006

Fax: +82-31-851-6015

Cell: +82-10-3934-9006

Email: smac.korea@yahoo.com

Website: www.smac-mca.co.kr

SMAC China (Shanghai)

Tel: +86 (0)21-6435-1661

Fax: +86 (0)21-3429-0092

Cell: +86 (0)133-1186-5359

Email: smac.sh@163.com

SMAC China (Shenzhen)

Tel: +86 134-2899-5922

Email: kerwin@smac-china.com

SMAC Malaysia

Tel: +6012 7036618

Email: tapahkheong99@yahoo.com

SMAC
Moving Coil Actuators