

# RCS3(P)-SA8/SS8 RCS3(P)CR-SA8/SS8



**1.8 times the maximum speed, 1.3 times the payload (\*)**  
**Highest-end models of ROBO Cylinder slider types have been updated.**  
**Enjoy significantly higher traveling performance and positioning repeatability.**



**RCS3-SA8C**  
 (Standard specification: Coupling type)



**RCS3-SA8R**  
 (Standard specification: Side mounted motor type)

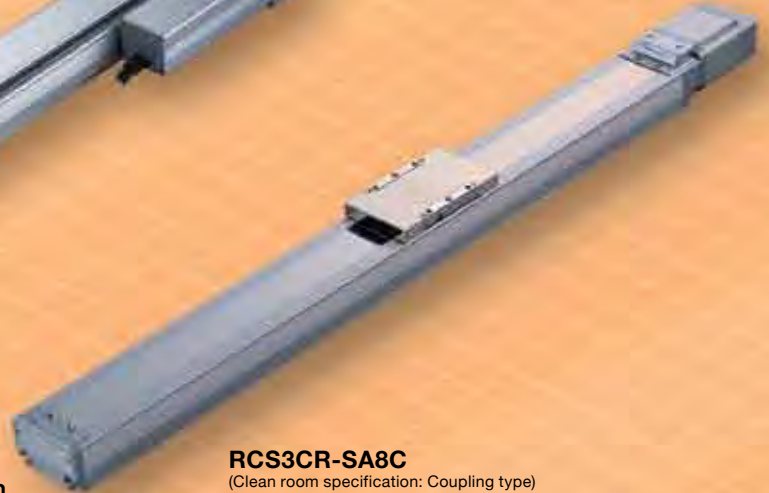

**RCS3CR-SA8C**  
 (Clean room specification: Coupling type)

**SA8 type** Aluminum base for weight/cost reduction

## 1 High speed & high acceleration/deceleration

The high-speed performance characterized by 1800 mm/s of maximum speed and 1 G of maximum acceleration/deceleration leads to a shorter cycle time of your equipment.

### [Comparison of required time based on travel of 600 mm]

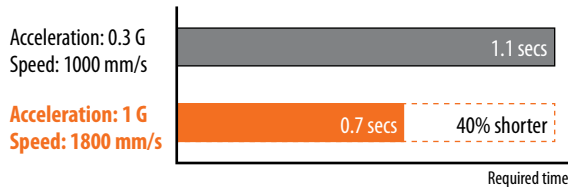

## 2 High payload

The compact body of only 80 mm in width can support up to 80 kg along a horizontal path. Wide-ranging variations are available and by combining one of two motors (100 W/150 W) with a desirable ball screw lead, you can certainly select a model that best suits your specific application.

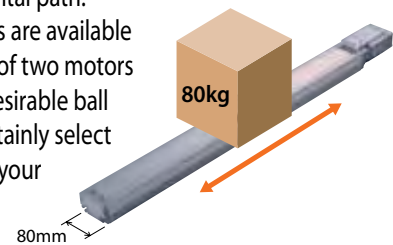

## 3 High precision

High-precision types (RCS3P/RCS3PCR) boasting a positioning repeatability of  $\pm 0.01$  mm have been added to the series. They can be used for applications requiring precise positioning.

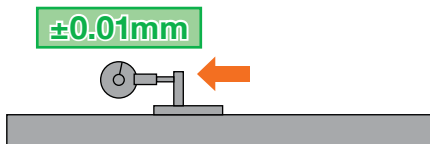

## 4 Clean room specifications

Clean room specifications have been added to the SA8/SS8 types. These models let you achieve class 10 cleanliness with a minimum suction rate.



# The birth of compact, high-performance motorized actuators. Utilize them to make your system smaller and faster.



**RCS3-SS8C**  
(Standard specification: Coupling type)

**RCS3-SS8R**  
(Standard specification: Side mounted motor type)

**RCS3CR-SS8C**  
(Clean room specification: Coupling type)

## SS8 type Iron base for high rigidity

### 5 Compact & rigid

The compact motor unit design made it possible to shorten the overall length by 116.5 mm compared to a comparable existing model. You can also choose a lightweight aluminum base or a rigid iron base.

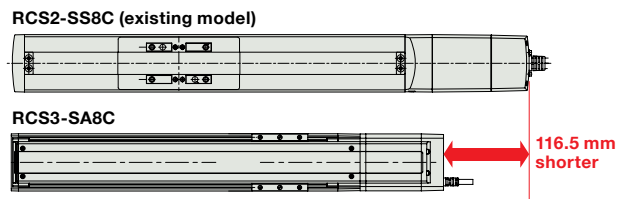

### 7 Expanded lineup with side mounted motor types

The product lineup has been expanded with side mounted motor types. These actuators are shorter than coupling types by 65 mm in overall length, thereby saving space.

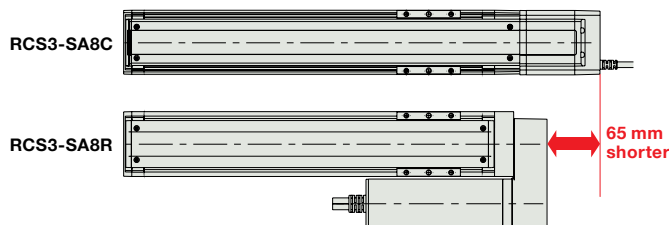

### 6 Cable exit directions

You can select one of four directions from which the motor/encoder cables exit according to the requirement for installation space.

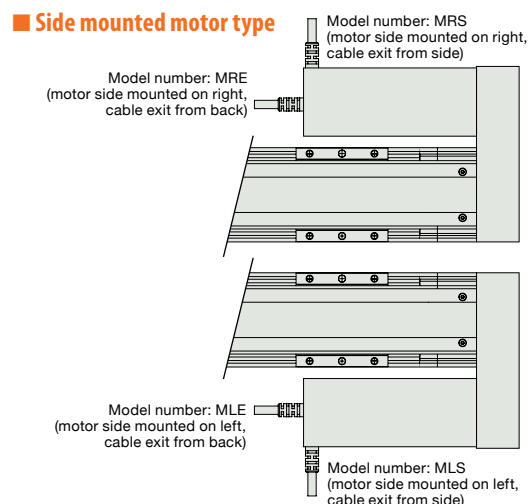
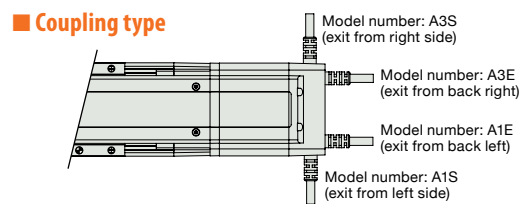



## Specification List

Category	Series	Type	Base material	Motor output (W)	Ball screw lead (mm)	Maximum speed (mm/sec) (Note 1)	Maximum payload (kg)		Acceleration (G)		Stroke (mm)	Allowable dynamic moment (N-m) (Note 2)			Page						
							Horizontal	Vertical	Rated	Maximum		Ma	Mb	Mc							
Standard specification	RCS3 (Standard specification)	SA8C	Aluminum base	100	30	1800	8	2	0.3	1	50 to 1100 (every 50 mm)	23.1	32.9	54.1	P.5						
					20	1200	20	4	0.3	0.7											
					10	600	40	8	0.3	0.5											
					5	300	80	16	0.2	0.3											
					30	1800	12	3	0.3	1											
		150	20	1200	30	6	0.3	0.7													
			10	600	60	12	0.3	0.5													
			30	1800	8	2	0.3	1													
			100	20	1200	20	4	0.3	0.7												
				10	600	40	8	0.3	0.5												
	5	300		80	16	0.2	0.3														
	150	30	1800	12	3	0.3	1														
		20	1200	30	6	0.3	0.7														
		10	600	60	12	0.3	0.5														
		SA8R	Aluminum base	100	30	1800	8	2	0.3	1											
					20	1200	20	4	0.3	0.7											
	10				600	40	8	0.3	0.5												
	5				300	80	16	0.2	0.3												
	30				1800	12	3	0.3	1												
	150	20	1200	30	6	0.3	0.7														
10		600	60	12	0.3	0.5															
SS8R		Iron base	100	30	1800	8	2	0.3	1												
				20	1200	20	4	0.3	0.7												
				10	600	40	8	0.3	0.5												
	5			300	80	16	0.2	0.3													
	30			1800	12	3	0.3	1													
150	20	1200	30	6	0.3	0.7															
	10	600	60	12	0.3	0.5															
	Clean room specification	RCS3CR (Standard specification)	SA8C	Aluminum base	100	30	1800	8	2	0.3	1	50 to 1100 (every 50 mm)	23.1	32.9	54.1	P.13					
						20	1200	20	4	0.3	0.7										
						10	600	40	8	0.3	0.5										
5						300	80	16	0.2	0.3											
30						1800	12	3	0.3	1											
150		20	1200	30	6	0.3	0.7														
		10	600	60	12	0.3	0.5														
		RCS3PCR (High-precision specification)	SS8C	Iron base	100	30	1800	8	2	0.3	1						50 to 1000 (every 50 mm)	36.3	36.3	77.4	P.15
						20	1200	20	4	0.3	0.7										
						10	600	40	8	0.3	0.5										
5	300					80	16	0.2	0.3												
30	1800					12	3	0.3	1												
150	20	1200	30	6	0.3	0.7															
	10	600	60	12	0.3	0.5															

(Note 1) If the stroke is short, the corresponding maximum speed may not be reached.  
When the stroke is increased, on the other hand, the maximum speed will drop to prevent reaching dangerous speeds.  
For details, refer to the page explaining the specification of each model.

(Note 2) When the travel life is assumed as 10,000 km.

## Table of Payloads by Acceleration

The following table applies commonly to the RCS3, RCS3P, RCS3CR and RCS3PCR series.

Type	Motor wattage	Ball screw lead	Installation orientation	Payloads by acceleration				
				0.2G	0.3G	0.5G	0.7G	1.0G
SA8C SS8C SA8R SS8R	100W	30	Horizontal	8	8	6	4	1
			Vertical	2	2	1.5	1	—
		20	Horizontal	20	20	10	5	—
			Vertical	4	4	2	1.5	—
		10	Horizontal	40	40	20	—	—
			Vertical	8	8	4	—	—
	5	Horizontal	80	65	—	—	—	
		Vertical	16	12	—	—	—	
	150W	30	Horizontal	12	12	10	6	2
			Vertical	3	3	2	1.5	—
		20	Horizontal	30	30	15	7.5	—
			Vertical	6	6	3	2	—
10		Horizontal	60	60	30	—	—	
		Vertical	12	12	6	—	—	

## Explanation of Model Specification Items

\*The selectable options for each item vary depending on the type. Check the details on the page explaining each type.

Example) **RCS3 SA8C I 150 30 1100 T2 S A1E**

Series      Type      Encoder type      Motor type      Lead      Stroke      Applicable controller      Cable type      Option

RCS3	Standard specification with servo motor		100	100W		T1	XSEL-J/K	A1E	Cable exit from back left
RCS3P	High-precision specification with servo motor		150	150W			SCON	A1S	Cable exit from left side
RCS3CR	Clean room specification with servo motor					T2	SSEL	A3E	Cable exit from back right
RCS3PCR	High-precision clean room specification with servo motor						XSEL-P/Q	A3S	Cable exit from right side
			30	30mm				B	Brake
			20	20mm				MLE	Motor is mounted on the left side, cable exit from back
			10	10mm				MLS	Motor is mounted on the left side, cable exit from side
			5	5mm				MRE	Motor is mounted on the right side, cable exit from back
								MRS	Motor is mounted on the right side, cable exit from side
			50	50mm				NM	Reversed-home specification
			5	5mm				SR	Slider roller specification
			1100	1100mm				VL	L-shaped suction joint specification
								VN	No suction joint

\* For the side mounted motor types, this option is selectable only when "RCS3" or "RCS3P" has been selected.

\* Up to 1000 mm for SS8C/SS8R

A	Absolute specification
I	Incremental specification

## Explanation of Options

Option code	Name	Description	Applicable models					
			RCS3/RCS3P				RCS3CR/RCS3PCR	
			SA8C	SS8C	SA8R	SS8R	SA8C	SS8C
A1E	Cable exit from back left	Specify a desired code indicating the actuator cable exit direction.						
A1S	Cable exit from left side							
A3E	Cable exit from back right							
A3S	Cable exit from right side							
B	Brake	If the actuator is used vertically, a brake is used to prevent the slider from dropping when the power is turned off.						
MLE	Motor mounted on left, cable exit from back	For a side mounted motor type, specify a desired code indicating the side that the motor will be mounted on and actuator cable exit direction.						
MLS	Motor mounted on left, cable exit from side							
MRE	Motor mounted on right, cable exit from back							
MRS	Motor mounted on right, cable exit from side							
NM	Reversed-home specification	Specify this code if you want to change the direction of home. (Standard: Motor side / Reversed home: Front side)						
SR	Slider roller specification	The scraper normally installed on the slider is changed with the same rollers used on the clean room specification.						
VL	L-shaped suction joint specification	The suction joint of the clean room specification is changed from the straight type to L-shaped type.						
VN	No suction joint	Same as the clean room specification, less the suction joint.						

### Cable Exit Direction

#### Coupling type

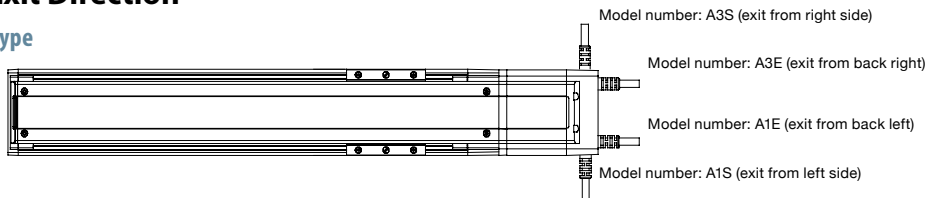

#### Side mounted motor type

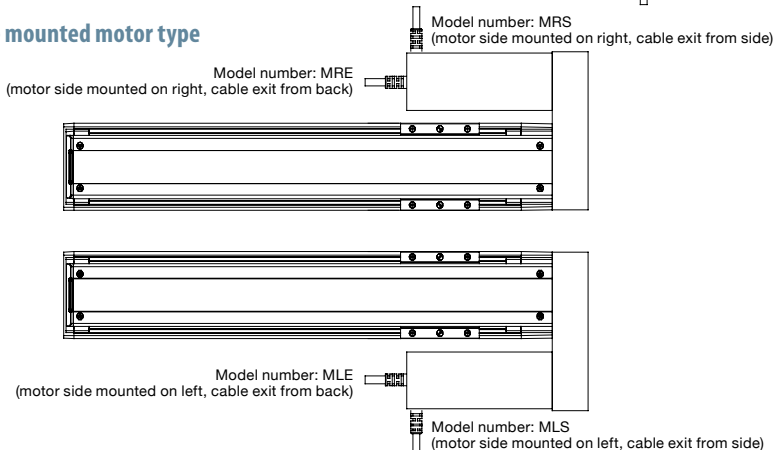

# RCS3-SA8C

ROBO Cylinder, Slider Type, Actuator Width 80 mm, 200-V Servo Motor, Aluminum Base, Coupling

# RCS3P-SA8C

ROBO Cylinder, Slider Type, Actuator Width 80 mm, 200-V Servo Motor, Aluminum Base, Coupling

High-precision specification

Model Specification Items	Series	Type	Encoder type	Motor type	Lead	Stroke	Applicable controller	Cable length	Options
	RCS3: Standard specification RCS3P: High-precision specification	SA8C	I: Incremental specification A: Absolute specification	100: Servo motor, 100 W 150: Servo motor, 150 W	30: 30 mm 20: 20 mm 10: 10 mm 5: 5 mm	50: 50 mm 1100: 1100 mm (specifiable in 50 mm increments)	T1: XSEL-J/K T2: SCON SSEL XSEL-P/Q	N: None P: 1 m S: 3 m M: 5 m X□□: Specified length R□□: Robot cable	Refer to the option table below. * Be sure to specify a code indicating your desired cable exit direction.

\* For contents of the model specification items, refer to page 4.



**POINT**  
Notes on selection

- When the stroke is increased, the maximum speed will drop to prevent reaching dangerous speeds of ball screws. Confirm the maximum speed at the desired stroke by referring to the table of strokes and maximum speeds below.
- The payload represents a value when the actuator is operated at a horizontal acceleration of 0.3 G (lead 5: 0.2 G) and vertical acceleration of 0.2 G.
- The payload drops when the acceleration is raised. For details, refer to the list of payloads by acceleration provided on page 3.

## Actuator Specifications

### Lead and Payloads

Model number	Motor output (W)	Lead (mm)	Maximum payload		Rated thrust (N)	Stroke (mm)	
			Horizontal (kg)	Vertical (kg)			
RCS3[RCS3P]-SA8C-①-100-30-②-③-④-⑤	100	30	8	2	56.6	50 to 1100 (every 50 mm)	
RCS3[RCS3P]-SA8C-①-100-20-②-③-④-⑤		20	20	4	84.9		
RCS3[RCS3P]-SA8C-①-100-10-②-③-④-⑤		10	40	8	169.8		
RCS3[RCS3P]-SA8C-①-100-5-②-③-④-⑤		5	80	16	339.7		
RCS3[RCS3P]-SA8C-①-150-30-②-③-④-⑤		150	30	12	3		85.1
RCS3[RCS3P]-SA8C-①-150-20-②-③-④-⑤			20	30	6		127.6
RCS3[RCS3P]-SA8C-①-150-10-②-③-④-⑤	10		60	12	255.3		

Code explanation ① Encoder type ② Stroke ③ Applicable controller ④ Cable length ⑤ Option

### Stroke and Maximum Speed (unit: mm/s)

Stroke / Lead	50 to 650 (every 50 mm)	700	750	800	850	900	950	1000	1050	1100
	30	1800	1610	1420	1260	1120	1010	910	830	760
20	1200	1070	940	840	750	670	610	550	500	460
10	600	530	470	410	370	340	310	270	250	230
5	300	260	230	200	180	170	150	135	120	110

### ① Encoder Type / ② Stroke

② Stroke (mm)	Standard Prices							
	RCS3-SA8C				RCS3P-SA8C			
	① Encoder Type				① Encoder Type			
	Incremental		Absolute		Incremental		Absolute	
	Motor wattage	Motor wattage	Motor wattage	Motor wattage	Motor wattage	Motor wattage	Motor wattage	Motor wattage
	100W	150W	100W	150W	100W	150W	100W	150W
50/100	-	-	-	-	-	-	-	-
150/200	-	-	-	-	-	-	-	-
250/300	-	-	-	-	-	-	-	-
350/400	-	-	-	-	-	-	-	-
450/500	-	-	-	-	-	-	-	-
550/600	-	-	-	-	-	-	-	-
650/700	-	-	-	-	-	-	-	-
750/800	-	-	-	-	-	-	-	-
850/900	-	-	-	-	-	-	-	-
950/1000	-	-	-	-	-	-	-	-
1050/1100	-	-	-	-	-	-	-	-

### ④ Cable Length

Type	Cable symbol	Standard price
Standard type	P (1m)	-
	S (3m)	-
	M (5m)	-
Special length	X06 (6m) ~ X10 (10m)	-
	X11 (11m) ~ X15 (15m)	-
	X16 (16m) ~ X20 (20m)	-
Robot cable	R01 (1m) ~ R03 (3m)	-
	R04 (4m) ~ R05 (5m)	-
	R06 (6m) ~ R10 (10m)	-
	R11 (11m) ~ R15 (15m)	-
	R16 (16m) ~ R20 (20m)	-

\* For the cables used for maintenance, refer to the back cover.

### ⑤ Options

Name	Option code	Page	Standard Prices
Cables exit from back left	A1E	→ P4	-
Cables exit from left side	A1S	→ P4	-
Cables exit from back right	A3E	→ P4	-
Cables exit from right side	A3S	→ P4	-
Brake	B	→ P4	-
Reversed-home specification	NM	→ P4	-

### Actuator Specifications RCS3P specifications are shown in []. (Other items are the same.)

Item	Description
Drive method	Ball screw, Ø16 mm, rolled C10 [rolled C5]
Positioning repeatability	±0.02 mm [±0.01 mm]
Lost motion	0.1 mm [0.05 mm] max.
Base	Material: Aluminum with white alumite treatment
Allowable static moment	Ma: 113.5 N·m Mb: 117 N·m Mc: 266 N·m
Allowable dynamic moment (*)	Ma: 23.1 N·m Mb: 32.9 N·m Mc: 54.1 N·m
Overhang load length	390 mm max. in Ma direction, 390 mm max. in Mb/Mc directions
Ambient operating temperature/humidity	0 to 40°C, 85% RH max. (No condensation)

(\*) When the traveling life is assumed as 10,000 km.

Direction of allowable load moment.

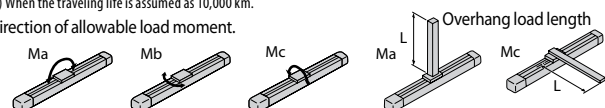

Diagram

CAD drawings are available for download from our website. Visit

www.intelligentactuator.com



- \*1 Connect the motor/encoder cables. Refer to the back cover for details on cables.
- \*2 The slider moves to the ME during home return, so pay attention to potential contact with surrounding parts/structures.  
ME: Mechanical End SE: Stroke End
- \*3 Reference position used when calculating the Ma moment

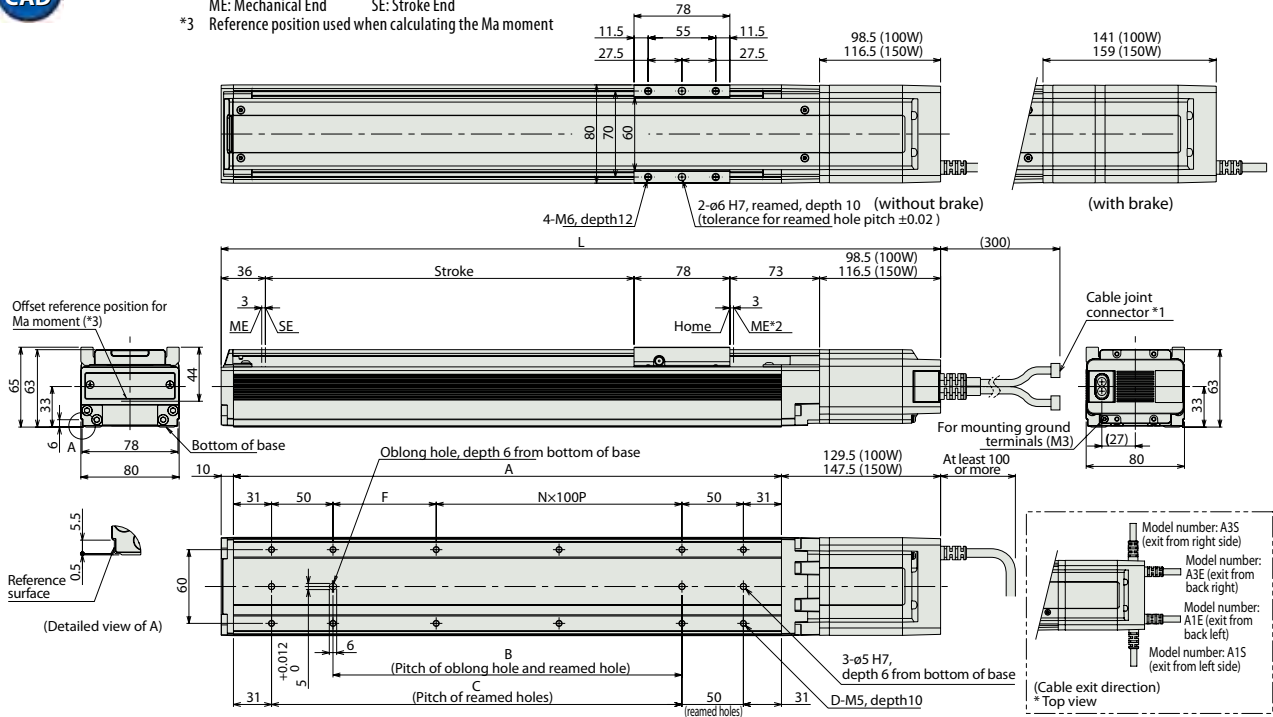

■ Dimensions and Weights by Stroke

Stroke	Stroke																							
	50	100	150	200	250	300	350	400	450	500	550	600	650	700	750	800	850	900	950	1000	1050	1100		
L	100W	without brake	335.5	385.5	435.5	485.5	535.5	585.5	635.5	685.5	735.5	785.5	835.5	885.5	935.5	985.5	1035.5	1085.5	1135.5	1185.5	1235.5	1285.5	1335.5	1385.5
		with brake	378	428	478	528	578	628	678	728	778	828	878	928	978	1028	1078	1128	1178	1228	1278	1328	1378	1428
	150W	without brake	353.5	403.5	453.5	503.5	553.5	603.5	653.5	703.5	753.5	803.5	853.5	903.5	953.5	1003.5	1053.5	1103.5	1153.5	1203.5	1253.5	1303.5	1353.5	1403.5
		with brake	396	446	496	546	596	646	696	746	796	846	896	946	996	1046	1096	1146	1196	1246	1296	1346	1396	1446
A	196	246	296	346	396	446	496	546	596	646	696	746	796	846	896	946	996	1046	1096	1146	1196	1246	1296	
B	34	84	134	184	234	284	334	384	434	484	534	584	634	684	734	784	834	884	934	984	1034	1084	1134	
C	84	134	184	234	284	334	384	434	484	534	584	634	684	734	784	834	884	934	984	1034	1084	1134	1184	
D	8	8	10	10	12	12	14	14	16	16	18	18	20	20	22	22	24	24	26	26	28	28	30	
F	34	84	34	84	34	84	34	84	34	84	34	84	34	84	34	84	34	84	34	84	34	84	34	
N	0	0	1	1	2	2	3	3	4	4	5	5	6	6	7	7	8	8	9	9	10	10	10	
Weight (kg)	100W	without brake	2.9	3.2	3.5	3.8	4.1	4.4	4.7	5.0	5.3	5.6	5.9	6.2	6.5	6.8	7.1	7.4	7.7	8.0	8.3	8.6	8.9	9.2
		with brake	3.3	3.6	3.9	4.2	4.5	4.8	5.1	5.4	5.7	6.0	6.3	6.6	6.9	7.2	7.5	7.8	8.1	8.4	8.7	9.0	9.3	9.6
	150W	without brake	3.0	3.3	3.6	3.9	4.2	4.5	4.8	5.1	5.4	5.7	6.0	6.3	6.6	6.9	7.2	7.5	7.8	8.1	8.4	8.7	9.0	9.3
		with brake	3.5	3.8	4.1	4.4	4.7	5.0	5.3	5.6	5.9	6.2	6.5	6.8	7.1	7.4	7.7	8.0	8.3	8.6	8.9	9.2	9.5	9.8

③ Applicable controllers

RCS3-series actuators can be operated with the following controllers. Select an appropriate controller type according to your application.

Name	External view	Model number	Features	Max # of positioning points	Input power supply	Power-supply capacity	Standard price	Page
Positioner mode		SCON-C-100①-NP-2-② SCON-C-150①-NP-2-②	Up to 512 positioning points are supported.	512 points	Single-phase 100VAC Single-phase 200VAC 3-phase 200 VAC (XSEL-P/Q only)	388 VA max. * 1-axis specification operated at 150 W	-	→ P17
Solenoid valve mode			Actuators can be operated through the same control used for solenoid valves.	7 points				
Serial communication type			Dedicated serial communication type	64 points				
Pulse-train input control type			Dedicated pulse-train input type	(-)				
Program control type, 1 to 2 axes		SSEL-C-1-100①-NP-2-② SSEL-C-1-150①-NP-2-②	Program operation is supported. Up to 2 axes can be operated.	20000 points				
Program control type, 1 to 6 axes		XSEL-③-1-100①-N1-EEE-2-④ XSEL-③-1-150①-N1-EEE-2-④	Program operation is supported. Up to 6 axes can be operated.	20000 points				

\* The information on SSEL and XSEL controllers are based on a 1-axis specification.  
 \* ① indicates the encoder type (I: Incremental / A: Absolute).  
 \* ② indicates the power-supply voltage type (1: 100 V / 2: Single-phase 200 V).  
 \* ③ indicates the XSEL type (I / K / P / Q).  
 \* ④ indicates the power-supply voltage type (1: 100 V / 2: Single-phase 200 V / 3: Three-phase 200 V).

# RCS3-SS8C

ROBO Cylinder, Slider Type, Actuator Width 80 mm, 200-V Servo Motor, Iron Base, Coupling

# RCS3P-SS8C

ROBO Cylinder, Slider Type, Actuator Width 80 mm, 200-V Servo Motor, Iron Base, Coupling

High-precision specification

Model Specification Items	Series	Type	Encoder type	Motor type	Lead	Stroke	Applicable controller	Cable length	Options
	RCS3: Standard specification RCS3P: High-precision specification	SS8C	I: Incremental specification A: Absolute specification	100: Servo motor, 100 W 150: Servo motor, 150 W	30: 30 mm 20: 20 mm 10: 10 mm 5: 5 mm	50: 50 mm 1000: 1000 mm (specifiable in 50 mm increments)	T1: XSEL-J/K T2: SCON SSEL XSEL-P/Q	N: None P: 1 m S: 3 m M: 5 m X□□: Specified length R□□: Robot cable	Refer to the option table below. * Be sure to specify a code indicating your desired cable exit direction.

\* For contents of the model specification items, refer to page 4.



**POINT**  
Notes on selection

- (1) When the stroke is increased, the maximum speed will drop to prevent reaching dangerous speeds of ball screws. Confirm the maximum speed at the desired stroke by referring to the table of strokes and maximum speeds below.
- (2) The payload represents a value when the actuator is operated at a horizontal acceleration of 0.3 G (lead 5: 0.2 G) and vertical acceleration of 0.2 G.
- (3) The payload drops when the acceleration is raised. For details, refer to the list of payloads by acceleration provided on page 3.

## Actuator Specifications

### Lead and Payloads

Model number	Motor output (W)	Lead (mm)	Maximum payload		Rated thrust (N)	Stroke (mm)	
			Horizontal (kg)	Vertical (kg)			
RCS3[RCS3P]-SS8C-①-100-30-②-③-④-⑤	100	30	8	2	56.6	50 to 1000 (every 50 mm)	
RCS3[RCS3P]-SS8C-①-100-20-②-③-④-⑤		20	20	4	84.9		
RCS3[RCS3P]-SS8C-①-100-10-②-③-④-⑤		10	40	8	169.8		
RCS3[RCS3P]-SS8C-①-100-5-②-③-④-⑤		5	80	16	339.7		
RCS3[RCS3P]-SS8C-①-150-30-②-③-④-⑤		150	30	12	3		85.1
RCS3[RCS3P]-SS8C-①-150-20-②-③-④-⑤			20	30	6		127.6
RCS3[RCS3P]-SS8C-①-150-10-②-③-④-⑤	10		60	12	255.3		

Code explanation ① Encoder type ② Stroke ③ Applicable controller ④ Cable length ⑤ Option

### Stroke and Maximum Speed (unit: mm/s)

Stroke / Lead	Maximum Speed (mm/s)								
	50 to 600 (every 50 mm)	650	700	750	800	850	900	950	1000
30	1800	1660	1460	1295	1155	1035	935	850	775
20	1200	1105	970	860	770	690	625	565	515
10	600	550	485	430	385	345	310	280	255
5	300	275	240	215	190	170	150	140	125

### ① Encoder Type / ② Stroke

② Stroke (mm)	Standard Prices							
	RCS3-SS8C				RCS3P-SS8C			
	① Encoder Type				① Encoder Type			
	Incremental		Absolute		Incremental		Absolute	
	Motor wattage	Motor wattage	Motor wattage	Motor wattage	Motor wattage	Motor wattage	Motor wattage	Motor wattage
	100W	150W	100W	150W	100W	150W	100W	150W
50/100	-	-	-	-	-	-	-	-
150/200	-	-	-	-	-	-	-	-
250/300	-	-	-	-	-	-	-	-
350/400	-	-	-	-	-	-	-	-
450/500	-	-	-	-	-	-	-	-
550/600	-	-	-	-	-	-	-	-
650/700	-	-	-	-	-	-	-	-
750/800	-	-	-	-	-	-	-	-
850/900	-	-	-	-	-	-	-	-
950/1000	-	-	-	-	-	-	-	-

### ④ Cable Length

Type	Cable symbol	Standard price
Standard type	P (1m)	-
	S (3m)	-
	M (5m)	-
Special length	X06 (6m) ~ X10 (10m)	-
	X11 (11m) ~ X15 (15m)	-
	X16 (16m) ~ X20 (20m)	-
Robot cable	R01 (1m) ~ R03 (3m)	-
	R04 (4m) ~ R05 (5m)	-
	R06 (6m) ~ R10 (10m)	-
	R11 (11m) ~ R15 (15m)	-
	R16 (16m) ~ R20 (20m)	-

\* For the cables used for maintenance, refer to the back cover.

### ⑤ Options

Name	Option code	Page	Standard Prices
Cables exit from back left	A1E	→ P4	-
Cables exit from left side	A1S	→ P4	-
Cables exit from back right	A3E	→ P4	-
Cables exit from right side	A3S	→ P4	-
Brake	B	→ P4	-
Reversed-home specification	NM	→ P4	-
Slider roller specification	SR	→ P4	-

### Actuator Specifications RCS3P specifications are shown in []. (Other items are the same.)

Item	Description
Drive method	Ball screw, $\phi$ 16 mm, rolled C10 [rolled CS]
Positioning repeatability	$\pm 0.02$ mm [ $\pm 0.01$ mm]
Lost motion	0.1 mm [0.05 mm] max.
Base	Material: Dedicated alloy steel
Allowable static moment	Ma: 198.9 N·m Mb: 198.9 N·m Mc: 416.7 N·m
Allowable dynamic moment (*)	Ma: 36.3 N·m Mb: 36.3 N·m Mc: 77.4 N·m
Overhang load length	450 mm max. in Ma direction, 450 mm max. in Mb/Mc directions
Ambient operating temperature/humidity	0 to 40°C, 85% RH max. (No condensation)

(\*) When the traveling life is assumed as 10,000 km.

Direction of allowable load moment.

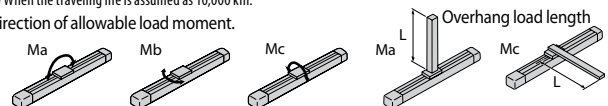



Diagram

CAD drawings are available for download from our website. Visit [www.intelligentactuator.com](http://www.intelligentactuator.com)



- \*1 Connect the motor/encoder cables. Refer to the back cover for details on cables.
- \*2 The slider moves to the ME during home return, so pay attention to potential contact with surrounding parts/structures.  
ME: Mechanical End SE: Stroke End
- \*3 Reference position used when calculating the Ma moment

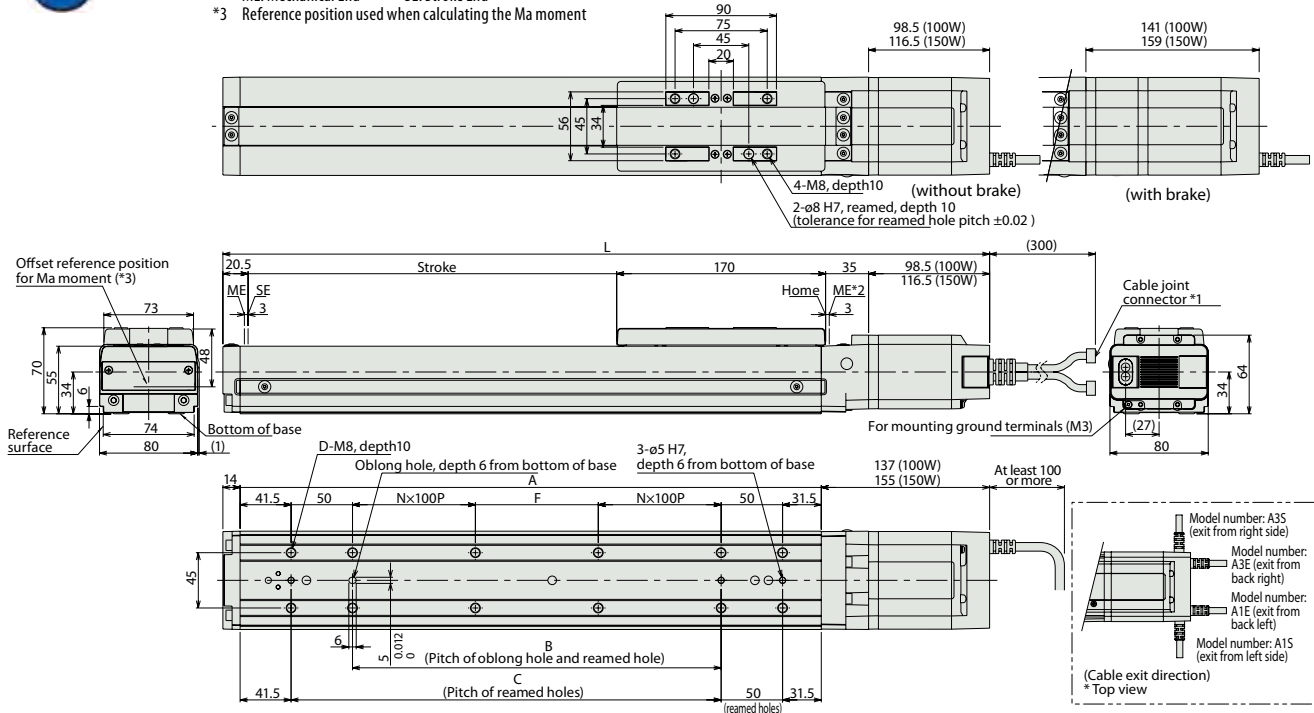

■ Dimensions and Weights by Stroke

L	Stroke	Stroke																				
		50	100	150	200	250	300	350	400	450	500	550	600	650	700	750	800	850	900	950	1000	
100W	without brake	374	424	474	524	574	624	674	724	774	824	874	924	974	1024	1074	1124	1174	1224	1274	1324	
	with brake	416.5	466.5	516.5	566.5	616.5	666.5	716.5	766.5	816.5	866.5	916.5	966.5	1016.5	1066.5	1116.5	1166.5	1216.5	1266.5	1316.5	1366.5	
150W	without brake	392	442	492	542	592	642	692	742	792	842	892	942	992	1042	1092	1142	1192	1242	1292	1342	
	with brake	434.5	484.5	534.5	584.5	634.5	684.5	734.5	784.5	834.5	884.5	934.5	984.5	1034.5	1084.5	1134.5	1184.5	1234.5	1284.5	1334.5	1384.5	
A		223	273	323	373	423	473	523	573	623	673	723	773	823	873	923	973	1023	1073	1123	1173	
B		50	100	150	200	250	300	350	400	450	500	550	600	650	700	750	800	850	900	950	1000	
C		100	150	200	250	300	350	400	450	500	550	600	650	700	750	800	850	900	950	1000	1050	
D		8	8	8	10	12	12	14	16	16	18	20	20	20	20	22	24	24	24	24	26	
F		50	100	150	0	50	100	150	0	50	100	150	0	50	100	150	0	50	100	150	0	
N		0	0	0	1	1	1	1	2	2	2	3	3	3	3	4	4	4	4	4	5	
Weight (kg)	100W	without brake	5.1	5.6	6.2	6.7	7.3	7.8	8.4	8.9	9.5	10.0	10.6	11.1	11.7	12.2	12.8	13.3	13.9	14.4	15.0	15.5
		with brake	5.5	6.0	6.6	7.1	7.7	8.2	8.8	9.3	9.9	10.4	11.0	11.5	12.1	12.6	13.2	13.7	14.3	14.8	15.4	15.9
	150W	without brake	5.1	5.7	6.2	6.8	7.3	7.9	8.4	9.0	9.5	10.1	10.6	11.2	11.7	12.3	12.8	13.4	13.9	14.5	15.0	15.6
		with brake	5.6	6.1	6.7	7.2	7.8	8.3	8.9	9.4	10.0	10.5	11.1	11.6	12.2	12.7	13.3	13.8	14.4	14.9	15.5	16.0

③ Applicable controllers

RCS3-series actuators can be operated with the following controllers. Select an appropriate controller type according to your application.

Name	External view	Model number	Features	Max # of positioning points	Input power supply	Power-supply capacity	Standard price	Page
Positioner mode		SCON-C-100①-NP-2-② SCON-C-150①-NP-2-②	Up to 512 positioning points are supported.	512 points	Single-phase 100VAC Single-phase 200VAC 3-phase 200 VAC (XSEL-P/Q only)	388 VA max. * 1-axis specification operated at 150 W	-	→ P17
Solenoid valve mode			Actuators can be operated through the same control used for solenoid valves.	7 points				
Serial communication type			Dedicated serial communication type	64 points				
Pulse-train input control type			Dedicated pulse-train input type	(-)				
Program control type, 1 to 2 axes		SSEL-C-1-100①-NP-2-② SSEL-C-1-150①-NP-2-②	Program operation is supported. Up to 2 axes can be operated.	20000 points				
Program control type, 1 to 6 axes		XSEL-③-1-100①-N1-EEE-2-④ XSEL-③-1-150①-N1-EEE-2-④	Program operation is supported. Up to 6 axes can be operated.	20000 points				

\* The information on SSEL and XSEL controllers are based on a 1-axis specification.  
 ① indicates the encoder type (I: Incremental / A: Absolute).  
 \* ② indicates the power-supply voltage type (1: 100 V / 2: Single-phase 200 V).  
 \* ③ indicates the XSEL type (J / K / P / Q).  
 \* ④ indicates the power-supply voltage type (1: 100 V / 2: Single-phase 200 V / 3: Three-phase 200 V).

# RCS3-SA8R

ROBO Cylinder, Slider Type, Actuator Width 80 mm, 200-V Servo Motor, Side Mounted Motor Specification with Aluminum Base

# RCS3P-SA8R

ROBO Cylinder, Slider Type, Actuator Width 80 mm, 200-V Servo Motor, Side Mounted Motor Specification With Aluminum Base

High-precision specification

Model Specification Items	Series	Type	Encoder type	Motor type	Lead	Stroke	Applicable controller	Cable length	Options
	RCS3: Standard specification RCS3P: High-precision specification	SA8R	I: Incremental specification A: Absolute specification	100: Servo motor, 100 W 150: Servo motor, 150 W	30: 30 mm 20: 20 mm 10: 10 mm 5: 5 mm	50: 50 mm 1100: 1100 mm (specifiable in 50 mm increments)	T1: XSEL-J/K T2: SCON SSEL XSEL-P/Q	N: None P: 1 m S: 3 m M: 5 m X□□: Specified length R□□: Robot cable	Refer to the option table below. * Be sure to specify a code indicating your desired cable exit direction.

\* For contents of the model specification items, refer to page 4.



**POINT**  
Notes on selection

- (1) When the stroke is increased, the maximum speed will drop to prevent reaching dangerous speeds of ball screws. Confirm the maximum speed at the desired stroke by referring to the table of strokes and maximum speeds below.
- (2) The payload represents a value when the actuator is operated at a horizontal acceleration of 0.3 G (lead 5: 0.2 G) and vertical acceleration of 0.2 G.
- (3) The payload drops when the acceleration is raised. For details, refer to the list of payloads by acceleration provided on page 3.

### Actuator Specifications

#### Lead and Payloads

Model number	Motor output (W)	Lead (mm)	Maximum payload		Rated thrust (N)	Stroke (mm)	
			Horizontal (kg)	Vertical (kg)			
RCS3[RCS3P]-SA8R-①-100-30-②-③-④-⑤	100	30	8	2	56.6	50 to 1100 (every 50 mm)	
RCS3[RCS3P]-SA8R-①-100-20-②-③-④-⑤		20	20	4	84.9		
RCS3[RCS3P]-SA8R-①-100-10-②-③-④-⑤		10	40	8	169.8		
RCS3[RCS3P]-SA8R-①-100-5-②-③-④-⑤		5	80	16	339.7		
RCS3[RCS3P]-SA8R-①-150-30-②-③-④-⑤		150	30	12	3		85.1
RCS3[RCS3P]-SA8R-①-150-20-②-③-④-⑤			20	30	6		127.6
RCS3[RCS3P]-SA8R-①-150-10-②-③-④-⑤	10		60	12	255.3		

#### Stroke and Maximum Speed (unit: mm/s)

Stroke (mm)	Maximum Speed (mm/s)									
	50 to 650 (every 50 mm)	700	750	800	850	900	950	1000	1050	1100
30	1800	1610	1420	1260	1120	1010	910	830	760	690
20	1200	1070	940	840	750	670	610	550	500	460
10	600	530	470	410	370	340	310	270	250	230
5	300	260	230	200	180	170	150	135	120	110

Code explanation ① Encoder type ② Stroke ③ Applicable controller ④ Cable length ⑤ Option

#### ① Encoder Type / ② Stroke

② Stroke (mm)	Standard Prices							
	RCS3-SA8R				RCS3P-SA8R			
	① Encoder Type		① Encoder Type		① Encoder Type		① Encoder Type	
	Incremental	Absolute	Incremental	Absolute	Incremental	Absolute	Incremental	Absolute
	Motor wattage		Motor wattage		Motor wattage		Motor wattage	
	100W	150W	100W	150W	100W	150W	100W	150W
50/100	-	-	-	-	-	-	-	-
150/200	-	-	-	-	-	-	-	-
250/300	-	-	-	-	-	-	-	-
350/400	-	-	-	-	-	-	-	-
450/500	-	-	-	-	-	-	-	-
550/600	-	-	-	-	-	-	-	-
650/700	-	-	-	-	-	-	-	-
750/800	-	-	-	-	-	-	-	-
850/900	-	-	-	-	-	-	-	-
950/1000	-	-	-	-	-	-	-	-
1050/1100	-	-	-	-	-	-	-	-

#### ④ Cable Length

Type	Cable symbol	Standard price
Standard type	P (1m)	-
	S (3m)	-
	M (5m)	-
Special length	X06 (6m) ~ X10 (10m)	-
	X11 (11m) ~ X15 (15m)	-
	X16 (16m) ~ X20 (20m)	-
Robot cable	R01 (1m) ~ R03 (3m)	-
	R04 (4m) ~ R05 (5m)	-
	R06 (6m) ~ R10 (10m)	-
	R11 (11m) ~ R15 (15m)	-
	R16 (16m) ~ R20 (20m)	-

\* For the cables used for maintenance, refer to the back cover.

#### ⑤ Options

Name	Option code	Page	Standard Prices
Brake	B	→ P4	-
Motor mounted on left, cable exit from back	MLE	→ P4	-
Motor mounted on left, cable exit from side	MLS	→ P4	-
Motor mounted on right, cable exit from back	MRE	→ P4	-
Motor mounted on right, cable exit from side	MRS	→ P4	-
Reversed-home specification	NM	→ P4	-

#### Actuator Specifications (RCS3P specifications are shown in [ ]. (Other items are the same.))

Item	Description
Drive method	Ball screw, Ø16 mm, rolled C10 [rolled C5]
Positioning repeatability	±0.02 mm [±0.01 mm]
Lost motion	0.1 mm [0.05 mm] max.
Base	Material: Aluminum with white alumite treatment
Allowable static moment	Ma: 113.5 N·m Mb: 177 N·m Mc: 266 N·m
Allowable dynamic moment (*)	Ma: 23.1 N·m Mb: 32.9 N·m Mc: 54.1 N·m
Overhang load length	390 mm max. in Ma direction, 390 mm max. in Mb/Mc directions
Ambient operating temperature/humidity	0 to 40°C, 85% RH max. (No condensation)

(\*) When the traveling life is assumed as 10,000 km.

Direction of allowable load moment.

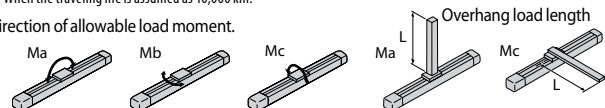

Diagram

CAD drawings are available for download from our website. Visit [www.intelligentactuator.com](http://www.intelligentactuator.com)



- \*1 Connect the motor/encoder cables. Refer to the back cover for details on cables.
- \*2 The slider moves to the ME during home return, so pay attention to potential contact with surrounding parts/structures.  
ME: Mechanical End SE: Stroke End
- \*Offset reference position for Ma moment is same as that of SA8C type. (Refer to page 6.)

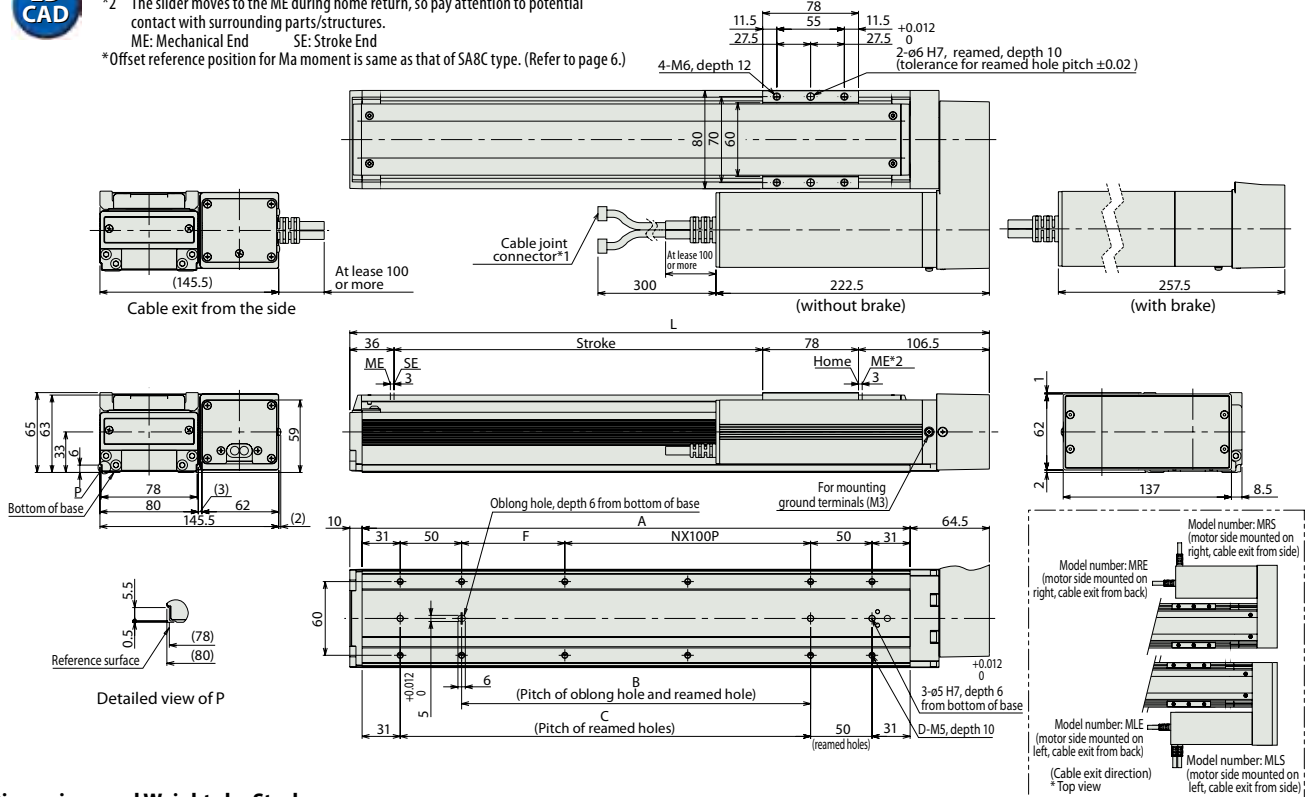

■ Dimensions and Weights by Stroke

Stroke	50	100	150	200	250	300	350	400	450	500	550	600	650	700	750	800	850	900	950	1000	1050	1100		
L	270.5	320.5	370.5	420.5	470.5	520.5	570.5	620.5	670.5	720.5	770.5	820.5	870.5	920.5	970.5	1020.5	1070.5	1120.5	1170.5	1220.5	1270.5	1320.5		
A	196	246	296	346	396	446	496	546	596	646	696	746	796	846	896	946	996	1046	1096	1146	1196	1246		
B	34	84	134	184	234	284	334	384	434	484	534	584	634	684	734	784	834	884	934	984	1034	1084		
C	84	134	184	234	284	334	384	434	484	534	584	634	684	734	784	834	884	934	984	1034	1084	1134		
D	8	8	10	10	12	12	14	14	16	16	18	18	20	20	22	22	24	24	26	26	28	28		
F	34	84	34	84	34	84	34	84	34	84	34	84	34	84	34	84	34	84	34	84	34	84		
N	0	0	1	1	2	2	3	3	4	4	5	5	6	6	7	7	8	8	9	9	10	10		
Weight (kg)	100W	without brake	3.6	3.9	4.2	4.5	4.8	5.1	5.4	5.7	6.0	6.3	6.6	6.9	7.2	7.5	7.8	8.1	8.4	8.7	9.0	9.3	9.6	9.9
		with brake	4.0	4.3	4.6	4.9	5.2	5.5	5.8	6.1	6.4	6.7	7.0	7.3	7.6	7.9	8.2	8.5	8.8	9.1	9.4	9.7	10.0	10.3
150W	without brake	3.8	4.1	4.4	4.7	5.0	5.3	5.6	5.9	6.2	6.5	6.8	7.1	7.4	7.7	8.0	8.3	8.6	8.9	9.2	9.5	9.8	10.1	
	with brake	4.1	4.4	4.7	5.0	5.3	5.6	5.9	6.2	6.5	6.8	7.1	7.4	7.7	8.0	8.3	8.6	8.9	9.2	9.5	9.8	10.1	10.4	

③ Applicable controllers

RCS3-series actuators can be operated with the following controllers. Select an appropriate controller type according to your application.

Name	External view	Model number	Features	Max # of positioning points	Input power supply	Power-supply capacity	Standard price	Page
Positioner mode		SCON-C-100①-NP-2-② SCON-C-150①-NP-2-②	Up to 512 positioning points are supported.	512 points	Single-phase 100VAC Single-phase 200VAC 3-phase 200 VAC (XSEL-P/Q only)	388 VA max. * 1-axis specification operated at 150 W	-	→ P17
Solenoid valve mode			Actuators can be operated through the same control used for solenoid valves.	7 points				
Serial communication type			Dedicated serial communication type	64 points				
Pulse-train input control type			Dedicated pulse-train input type	(-)				
Program control type, 1 to 2 axes		SSEL-C-1-100①-NP-2-② SSEL-C-1-150①-NP-2-②	Program operation is supported. Up to 2 axes can be operated.	20000 points				
Program control type, 1 to 6 axes		XSEL-③-1-100①-N1-EEE-2-④ XSEL-③-1-150①-N1-EEE-2-④	Program operation is supported. Up to 6 axes can be operated.	20000 points				

\* The information on SSEL and XSEL controllers are based on a 1-axis specification.  
 ① indicates the encoder type (I: Incremental / A: Absolute).  
 ② indicates the power-supply voltage type (1: 100 V / 2: Single-phase 200 V).  
 ③ indicates the XSEL type (I / K / P / Q).  
 ④ indicates the power-supply voltage type (1: 100 V / 2: Single-phase 200 V / 3: Three-phase 200 V).

# RCS3-SS8R

ROBO Cylinder, Slider Type, Actuator Width 80 mm, 200-V Servo Motor, Side Mounted Motor Specification With Iron Base

# RCS3P-SS8R

ROBO Cylinder, Slider Type, Actuator Width 80 mm, 200-V Servo Motor, Side Mounted Motor Specification With Iron Base

High-precision specification

Model Specification Items	Series	Type	Encoder type	Motor type	Lead	Stroke	Applicable controller	Cable length	Options
	RCS3: Standard specification RCS3P: High-precision specification	SS8R	I: Incremental specification A: Absolute specification	100: Servo motor, 100 W 150: Servo motor, 150 W	30: 30 mm 20: 20 mm 10: 10 mm 5: 5 mm	50: 50 mm ? : ? 1000: 1000 mm (specifiable in 50 mm increments)	T1: XSEL-J/K T2: SCON SSEL XSEL-P/Q	N: None P: 1 m S: 3 m M: 5 m X□□: Specified length R□□: Robot cable	Refer to the option table below. * Be sure to specify a code indicating your desired cable exit direction.
	* For contents of the model specification items, refer to page 4.								



- (1) When the stroke is increased, the maximum speed will drop to prevent reaching dangerous speeds of ball screws. Confirm the maximum speed at the desired stroke by referring to the table of strokes and maximum speeds below.
- (2) The payload represents a value when the actuator is operated at a horizontal acceleration of 0.3 G (lead 5: 0.2 G) and vertical acceleration of 0.2 G.
- (3) The payload drops when the acceleration is raised. For details, refer to the list of payloads by acceleration provided on page 3.

## Actuator Specifications

### Lead and Payloads

Model number	Motor output (W)	Lead (mm)	Maximum payload		Rated thrust (N)	Stroke (mm)	
			Horizontal (kg)	Vertical (kg)			
RCS3[RCS3P]-SS8R-①-100-30-②-③-④-⑤	100	30	8	2	56.6	50 to 1000 (every 50 mm)	
RCS3[RCS3P]-SS8R-①-100-20-②-③-④-⑤		20	20	4	84.9		
RCS3[RCS3P]-SS8R-①-100-10-②-③-④-⑤		10	40	8	169.8		
RCS3[RCS3P]-SS8R-①-100-5-②-③-④-⑤		5	80	16	339.7		
RCS3[RCS3P]-SS8R-①-150-30-②-③-④-⑤		150	30	12	3		85.1
RCS3[RCS3P]-SS8R-①-150-20-②-③-④-⑤			20	30	6		127.6
RCS3[RCS3P]-SS8R-①-150-10-②-③-④-⑤	10		60	12	255.3		

Code explanation ① Encoder type ② Stroke ③ Applicable controller ④ Cable length ⑤ Option

### Stroke and Maximum Speed (unit: mm/s)

Stroke / Lead	Maximum Speed (mm/s)									
	50 to 600 (every 50 mm)	650	700	750	800	850	900	950	1000	
30	1800	1660	1460	1295	1155	1035	935	850	775	
20	1200	1105	970	860	770	690	625	565	515	
10	600	550	485	430	385	345	310	280	255	
5	300	275	240	215	190	170	150	140	125	

### ① Encoder Type / ② Stroke

② Stroke (mm)	Standard Prices							
	RCS3-SS8C				RCS3P-SS8C			
	① Encoder Type							
	Incremental		Absolute		Incremental		Absolute	
	Motor wattage	Motor wattage	Motor wattage	Motor wattage	Motor wattage	Motor wattage	Motor wattage	
	100W	150W	100W	150W	100W	150W	100W	150W
50/100	-	-	-	-	-	-	-	-
150/200	-	-	-	-	-	-	-	-
250/300	-	-	-	-	-	-	-	-
350/400	-	-	-	-	-	-	-	-
450/500	-	-	-	-	-	-	-	-
550/600	-	-	-	-	-	-	-	-
650/700	-	-	-	-	-	-	-	-
750/800	-	-	-	-	-	-	-	-
850/900	-	-	-	-	-	-	-	-
950/1000	-	-	-	-	-	-	-	-

### ④ Cable Length

Type	Cable symbol	Standard price
Standard type	P (1m)	-
	S (3m)	-
	M (5m)	-
Special length	X06 (6m) ~ X10 (10m)	-
	X11 (11m) ~ X15 (15m)	-
	X16 (16m) ~ X20 (20m)	-
Robot cable	R01 (1m) ~ R03 (3m)	-
	R04 (4m) ~ R05 (5m)	-
	R06 (6m) ~ R10 (10m)	-
	R11 (11m) ~ R15 (15m)	-
	R16 (16m) ~ R20 (20m)	-

\* For the cables used for maintenance, refer to the back cover.

### ⑤ Options

Name	Option code	Page	Standard Prices
Brake	B	→ P4	-
Motor mounted on left, cable exit from back	MLE	→ P4	-
Motor mounted on left, cable exit from side	MLS	→ P4	-
Motor mounted on right, cable exit from back	MRE	→ P4	-
Motor mounted on right, cable exit from side	MRS	→ P4	-
Reversed-home specification	NM	→ P4	-
Slider roller specification	SR	→ P4	-

### Actuator Specifications (RCS3P specifications are shown in [ ]). (Other items are the same.)

Item	Description
Drive method	Ball screw, Ø16 mm, rolled C10 [rolled C5]
Positioning repeatability	±0.02 mm [±0.01 mm]
Lost motion	0.1 mm [0.05 mm] max.
Base	Material: Dedicated alloy steel
Allowable static moment	Ma: 198.9 N·m Mb: 198.9 N·m Mc: 416.7 N·m
Allowable dynamic moment (*)	Ma: 36.3 N·m Mb: 36.3 N·m Mc: 77.4 N·m
Overhang load length	450 mm max. in Ma direction, 450 mm max. in Mb/Mc directions
Ambient operating temperature/humidity	0 to 40°C, 85% RH max. (No condensation)

(\*) When the traveling life is assumed as 10,000 km.

Direction of allowable load moment.

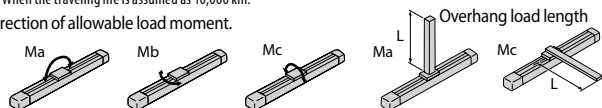



Diagram

CAD drawings are available for download from our website. Visit [www.intelligentactuator.com](http://www.intelligentactuator.com)



- \*1 Connect the motor/encoder cables. Refer to the back cover for details on cables.
- \*2 The slider moves to the ME during home return, so pay attention to potential contact with surrounding parts/structures.  
ME: Mechanical End SE: Stroke End
- \* Offset reference position for Ma moment is same as that of SS8C type. (Refer to page 8.)

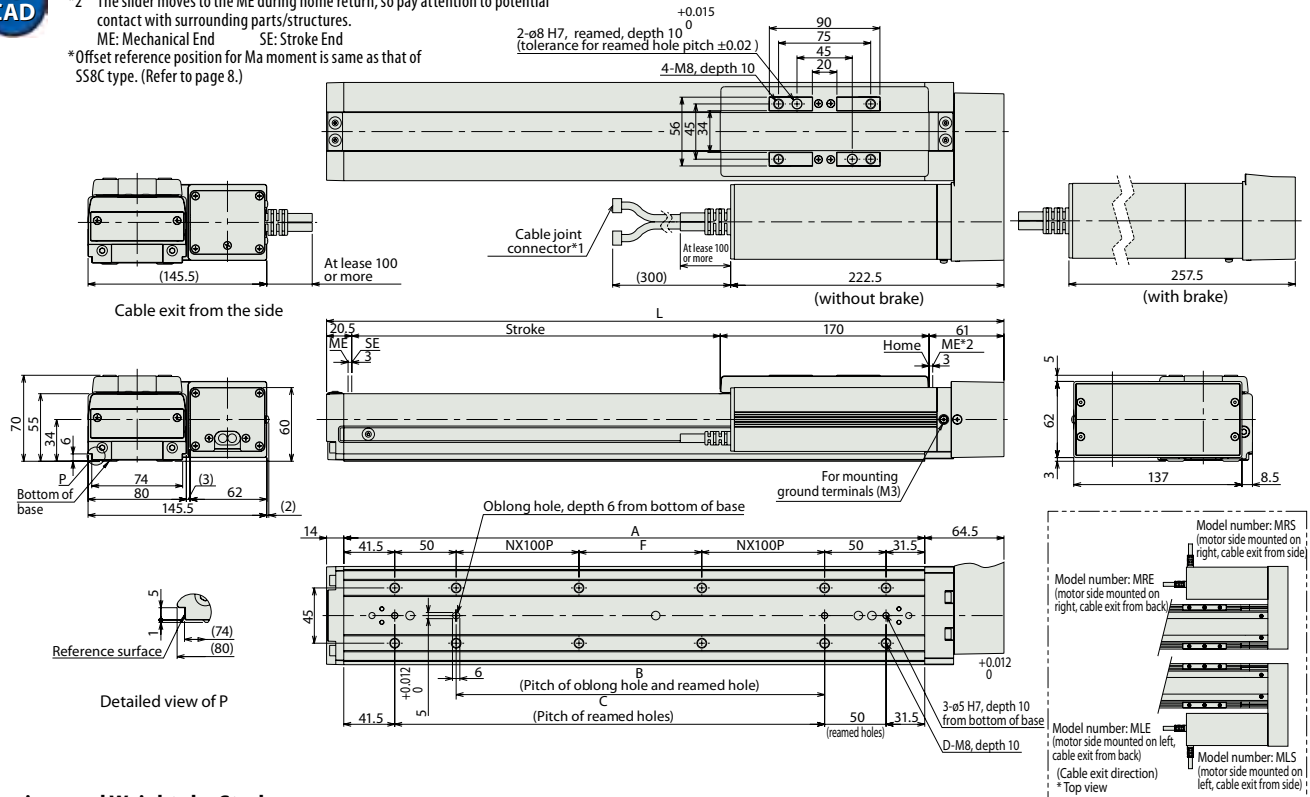

■ Dimensions and Weights by Stroke

Stroke	50	100	150	200	250	300	350	400	450	500	550	600	650	700	750	800	850	900	950	1000		
L	301.5	351.5	401.5	451.5	501.5	551.5	601.5	651.5	701.5	751.5	801.5	851.5	901.5	951.5	1001.5	1051.5	1101.5	1151.5	1201.5	1201.5		
A	223	273	323	373	423	473	523	573	623	673	723	773	823	873	923	973	1023	1073	1123	1173		
B	50	100	150	200	250	300	350	400	450	500	550	600	650	700	750	800	850	900	950	1000		
C	100	150	200	250	300	350	400	450	500	550	600	650	700	750	800	850	900	950	1000	1050		
D	8	8	8	10	12	12	14	16	16	16	16	18	20	20	20	22	24	24	24	26		
F	50	100	150	0	50	100	150	0	50	100	150	0	50	100	150	0	50	100	150	0		
N	0	0	0	1	1	1	1	2	2	2	3	3	3	3	3	4	4	4	4	5		
Weight (kg)	100W	without brake	6.0	6.5	7.1	7.6	8.2	8.7	9.3	9.8	10.4	10.9	11.5	12.0	12.6	13.1	13.7	14.2	14.8	15.3	15.9	16.4
		with brake	6.3	6.8	7.4	7.9	8.5	9.0	9.6	10.1	10.7	11.2	11.8	12.3	12.9	13.4	14.0	14.5	15.1	15.6	16.2	16.7
	150W	without brake	6.1	6.6	7.2	7.7	8.3	8.8	9.4	9.9	10.5	11.0	11.6	12.1	12.7	13.2	13.8	14.3	14.9	15.4	16.0	16.5
		with brake	6.4	6.9	7.5	8.0	8.6	9.1	9.7	10.2	10.8	11.3	11.9	12.4	13.0	13.5	14.1	14.6	15.2	15.7	16.3	16.8

③ Applicable controllers

RCS3-series actuators can be operated with the following controllers. Select an appropriate controller type according to your application.

Name	External view	Model number	Features	Max # of positioning points	Input power supply	Power-supply capacity	Standard price	Page
Positioner mode		SCON-C-100①-NP-2-② SCON-C-150①-NP-2-②	Up to 512 positioning points are supported.	512 points	Single-phase 100VAC Single-phase 200VAC 3-phase 200 VAC (XSEL-P/Q only)	388 VA max. * 1-axis specification operated at 150 W	-	→ P17
Solenoid valve mode			Actuators can be operated through the same control used for solenoid valves.	7 points				
Serial communication type			Dedicated serial communication type	64 points				
Pulse-train input control type			Dedicated pulse-train input type	(-)				
Program control type, 1 to 2 axes		SSEL-C-1-100①-NP-2-② SSEL-C-1-150①-NP-2-②	Program operation is supported. Up to 2 axes can be operated.	20000 points				
Program control type, 1 to 6 axes		XSEL-③-1-100①-N1-EEE-2-④ XSEL-③-1-150①-N1-EEE-2-④	Program operation is supported. Up to 6 axes can be operated.	20000 points				

\* The information on SSEL and XSEL controllers are based on a 1-axis specification.  
 ① indicates the encoder type (I: Incremental / A: Absolute).  
 ② indicates the power-supply voltage type (1: 100 V / 2: Single-phase 200 V).  
 ③ indicates the XSEL type (J / K / P / Q).  
 ④ indicates the power-supply voltage type (1: 100 V / 2: Single-phase 200 V / 3: Three-phase 200 V).

# RCS3CR-SA8C

ROBO Cylinder for Clean Room, Slider Type, Actuator Width 80 mm, 200-V Servo Motor, Aluminum Base, Coupling

# RCS3PCR-SA8C

ROBO Cylinder for Clean Room, Slider Type, Actuator Width 80 mm, 200-V Servo Motor, Aluminum Base, Coupling  
**High-precision specification**

Model Specification Items	Series	Type	Encoder type	Motor type	Lead	Stroke	Applicable controller	Cable length	Options
	RCS3: Standard specification RCS3P: High-precision specification	SA8C	I: Incremental specification A: Absolute specification	100: Servo motor, 100 W 150: Servo motor, 150 W	30: 30 mm 20: 20 mm 10: 10 mm 5: 5 mm	50: 50 mm ~ 1100: 1100 mm (specifiable in 50 mm increments)	T1: XSEL-J/K T2: SCON SSEL XSEL-P/Q	N: None P: 1 m S: 3 m M: 5 m X□□: Specified length R□□: Robot cable	Refer to the option table below. * Be sure to specify a code indicating your desired cable exit direction.

\* For contents of the model specification items, refer to page 4.



**POINT**  
Notes on selection

- (1) When the stroke is increased, the maximum speed will drop to prevent reaching dangerous speeds of ball screws. Confirm the maximum speed at the desired stroke by referring to the table of strokes and maximum speeds below.
- (2) The payload represents a value when the actuator is operated at a horizontal acceleration of 0.3 G (lead 5: 0.2 G) and vertical acceleration of 0.2 G.
- (3) The payload drops when the acceleration is raised. For details, refer to the list of payloads by acceleration provided on page 3.

### Actuator Specifications

#### Lead and Payloads

Model number	Motor output (W)	Lead (mm)	Maximum payload		Rated thrust (N)	Stroke (mm)
			Horizontal (kg)	Vertical (kg)		
RCS3CR[RCS3PCR]-SA8C-①-100-30-②③④⑤	100	30	8	2	56.6	50 to 1100 (every 50 mm)
RCS3CR[RCS3PCR]-SA8C-①-100-20-②③④⑤		20	20	4	84.9	
RCS3CR[RCS3PCR]-SA8C-①-100-10-②③④⑤		10	40	8	169.8	
RCS3CR[RCS3PCR]-SA8C-①-100-5-②③④⑤		5	80	16	339.7	
RCS3CR[RCS3PCR]-SA8C-①-150-30-②③④⑤	150	30	12	3	85.1	
RCS3CR[RCS3PCR]-SA8C-①-150-20-②③④⑤		20	30	6	127.6	
RCS3CR[RCS3PCR]-SA8C-①-150-10-②③④⑤		10	60	12	255.3	

Code explanation ① Encoder type ② Stroke ③ Applicable controller ④ Cable length ⑤ Option

#### Stroke and Maximum Speed (unit: mm/s)

Stroke / Lead	Stroke (mm)										Suction rate (NL/min)
	50 to 650 every 50 mm	700	750	800	850	900	950	1000	1050	1100	
30	1800	1510	1340	1190	1070	960	870	790	720	660	130 (160)*
20	1200	1010	890	790	710	640	580	530	480	440	110
10	600	500	440	390	350	320	290	260	240	220	60
5	300	250	220	190	170	160	140	130	120	110	30

(\*) 130 NL/min if the speed is 1500 mm/s or below, or 160 NL/min if the speed exceeds 1500 mm/s.

#### ① Encoder Type / ② Stroke

② Stroke (mm)	Standard Prices							
	RCS3CR-SA8C				RCS3PCR-SA8C			
	① Encoder Type							
	Incremental Motor wattage		Absolute Motor wattage		Incremental Motor wattage		Absolute Motor wattage	
	100W	150W	100W	150W	100W	150W	100W	150W
50/100	-	-	-	-	-	-	-	-
150/200	-	-	-	-	-	-	-	-
250/300	-	-	-	-	-	-	-	-
350/400	-	-	-	-	-	-	-	-
450/500	-	-	-	-	-	-	-	-
550/600	-	-	-	-	-	-	-	-
650/700	-	-	-	-	-	-	-	-
750/800	-	-	-	-	-	-	-	-
850/900	-	-	-	-	-	-	-	-
950/1000	-	-	-	-	-	-	-	-
1050/1100	-	-	-	-	-	-	-	-

#### ④ Cable Length

Type	Cable symbol	Standard price
Standard type	P (1m)	-
	S (3m)	-
	M (5m)	-
Special length	X06 (6m) ~ X10 (10m)	-
	X11 (11m) ~ X15 (15m)	-
Robot cable	X16 (16m) ~ X20 (20m)	-
	R01 (1m) ~ R03 (3m)	-
	R04 (4m) ~ R05 (5m)	-
	R06 (6m) ~ R10 (10m)	-
	R11 (11m) ~ R15 (15m)	-
	R16 (16m) ~ R20 (20m)	-

\* For the cables used for maintenance, refer to the back cover.

#### ⑤ Options

Name	Option code	Page	Standard Prices
Cables exit from back left	A1E	→ P4	-
Cables exit from left side	A1S	→ P4	-
Cables exit from back right	A3E	→ P4	-
Cables exit from right side	A3S	→ P4	-
Brake	B	→ P4	-
Reversed-home specification	NM	→ P4	-
L-shaped suction joint specification	VL	→ P4	-
No suction joint	VN	→ P4	-

#### Actuator Specifications RCS3PCR specifications are shown in [ ]. (Other items are the same.)

Item	Description
Drive method	Ball screw, Ø16 mm, rolled C10 [rolled C5]
Positioning repeatability	±0.02 mm [±0.01 mm]
Lost motion	0.1 mm [0.05 mm] max.
Base	Material: Aluminum with white alumite treatment
Allowable static moment	Ma: 113.5 N·m Mb: 177 N·m Mc: 266 N·m
Allowable dynamic moment (*)	Ma: 23.1 N·m Mb: 32.9 N·m Mc: 54.1 N·m
Overhang load length	390 mm max. in Ma direction, 390 mm max. in Mb/Mc directions
Grease	Low dust-raising grease is used (for both the ball screw and guide).
Cleanliness class	Able to achieve cleanliness class 10 (0.1 µm).
Ambient operating temperature/humidity	0 to 40°C, 85% RH max. (No condensation)

(\*) When the traveling life is assumed as 10,000 km.

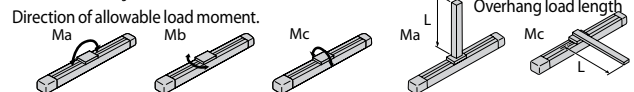

Diagram

CAD drawings are available for download from our website. Visit [www.intelligentactuator.com](http://www.intelligentactuator.com)



- \*1 Connect the motor/encoder cables. Refer to the back cover for details on cables.
- \*2 The slider moves to the ME during home return, so pay attention to potential contact with surrounding parts/structures.  
ME: Mechanical End SE: Stroke End
- \*3 Reference position used when calculating the Ma moment

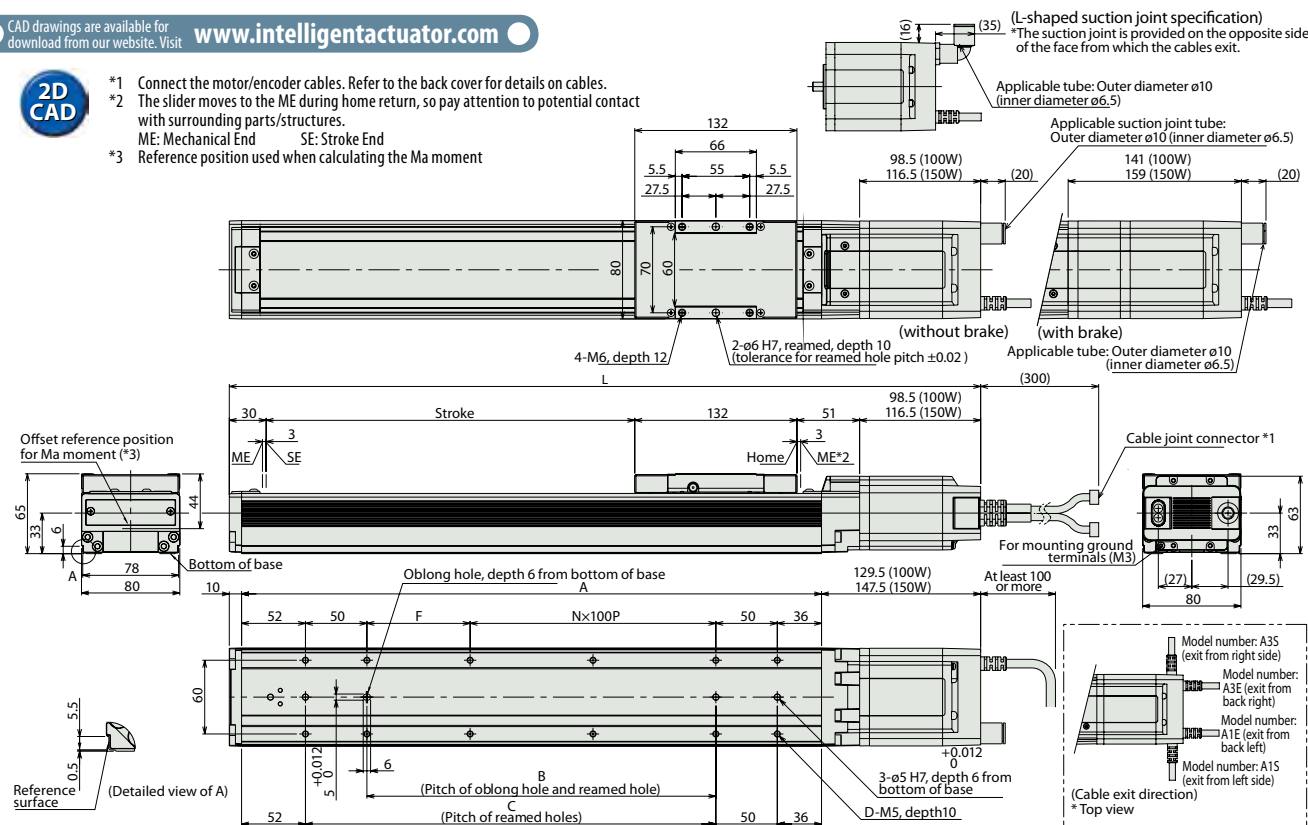

■ Dimensions and Weights by Stroke

Stroke		50	100	150	200	250	300	350	400	450	500	550	600	650	700	750	800	850	900	950	1000	1050	1100	
L	100W	without brake	361.5	411.5	461.5	511.5	561.5	611.5	661.5	711.5	761.5	811.5	861.5	911.5	961.5	1011.5	1061.5	1111.5	1161.5	1211.5	1261.5	1311.5	1361.5	1411.5
		with brake	404	454	504	554	604	654	704	754	804	854	904	954	1004	1054	1104	1154	1204	1254	1304	1354	1404	1454
	150W	without brake	379.5	429.5	479.5	529.5	579.5	629.5	679.5	729.5	779.5	829.5	879.5	929.5	979.5	1029.5	1079.5	1129.5	1179.5	1229.5	1279.5	1329.5	1379.5	1429.5
		with brake	422	472	522	572	622	672	722	772	822	872	922	972	1022	1072	1122	1172	1222	1272	1322	1372	1422	1472
A		222	272	322	372	422	472	522	572	622	672	722	772	822	872	922	972	1022	1072	1122	1172	1222	1272	
B		34	84	134	184	234	284	334	384	434	484	534	584	634	684	734	784	834	884	934	984	1034	1084	
C		84	134	184	234	284	334	384	434	484	534	584	634	684	734	784	834	884	934	984	1034	1084	1134	
D		8	8	10	10	12	12	14	14	16	16	18	18	20	20	22	22	24	24	26	26	28	28	
F		34	84	34	84	34	84	34	84	34	84	34	84	34	84	34	84	34	84	34	84	34	84	
N		0	0	1	1	2	2	3	3	4	4	5	5	6	6	7	7	8	8	9	9	10	10	
Weight (kg)	100W	without brake	2.8	3.1	3.4	3.7	4.0	4.3	4.6	4.9	5.2	5.5	5.8	6.1	6.4	6.7	7.0	7.3	7.6	7.9	8.2	8.5	8.8	9.1
		with brake	3.2	3.5	3.8	4.1	4.4	4.7	5.0	5.3	5.6	5.9	6.2	6.5	6.8	7.1	7.4	7.7	8.0	8.3	8.6	8.9	9.2	9.5
	150W	without brake	2.9	3.2	3.5	3.8	4.1	4.4	4.7	5.0	5.3	5.6	5.9	6.2	6.5	6.8	7.1	7.4	7.7	8.0	8.3	8.6	8.9	9.2
		with brake	3.4	3.7	4.0	4.3	4.6	4.9	5.2	5.5	5.8	6.1	6.4	6.7	7.0	7.3	7.6	7.9	8.2	8.5	8.8	9.1	9.4	9.7

③ Applicable controllers

RCS3CR-series actuators can be operated with the following controllers. Select an appropriate controller type according to your application.

Name	External view	Model number	Features	Max # of positioning points	Input power supply	Power-supply capacity	Standard price	Page
Positioner mode		SCON-C-100①-NP-2-② SCON-C-150①-NP-2-②	Up to 512 positioning points are supported.	512 points	Single-phase 100VAC Single-phase 200VAC 3-phase 200 VAC (XSEL-P/Q only)	388 VA max. * 1-axis specification operated at 150 W	-	→ P17
Solenoid valve mode			Actuators can be operated through the same control used for solenoid valves.	7 points				
Serial communication type			Dedicated serial communication type	64 points				
Pulse-train input control type			Dedicated pulse-train input type	(-)				
Program control type, 1 to 2 axes		SSEL-C-1-100①-NP-2-② SSEL-C-1-150①-NP-2-②	Program operation is supported. Up to 2 axes can be operated.	20000 points				
Program control type, 1 to 6 axes		XSEL-③-1-100①-N1-EEE-2-④ XSEL-③-1-150①-N1-EEE-2-④	Program operation is supported. Up to 6 axes can be operated.	20000 points				

\* The information on SSEL and XSEL controllers are based on a 1-axis specification.  
 ① indicates the encoder type (I: Incremental / A: Absolute).  
 ② indicates the power-supply voltage type (1: 100 V / 2: Single-phase 200 V).  
 ③ indicates the XSEL type (J / K / P / Q).  
 ④ indicates the power-supply voltage type (1: 100 V / 2: Single-phase 200 V / 3: Three-phase 200 V).

# RCS3CR-SS8C

ROBO Cylinder for Clean Room, Slider Type, Actuator Width 80 mm, 200-V Servo Motor, Aluminum Base, Coupling

# RCS3PCR-SS8C

ROBO Cylinder for Clean Room, Slider Type, Actuator Width 80 mm, 200-V Servo Motor, Aluminum Base, Coupling  
**High-precision specification**

Model Specification Items	Series	Type	Encoder type	Motor type	Lead	Stroke	Applicable controller	Cable length	Options
	RCS3: Standard specification RCS3P: High-precision specification	SS8C	I: Incremental specification A: Absolute specification	100: Servo motor, 100 W 150: Servo motor, 150 W	30: 30 mm 20: 20 mm 10: 10 mm 5: 5 mm	50: 50 mm } 1000: 1000 mm (specifiable in 50 mm increments)	T1: XSEL-J/K T2: SCON SSEL XSEL-P/Q	N: None P: 1 m S: 3 m M: 5 m X□□: Specified length R□□: Robot cable	Refer to the option table below. * Be sure to specify a code indicating your desired cable exit direction.
	* For contents of the model specification items, refer to page 4.								

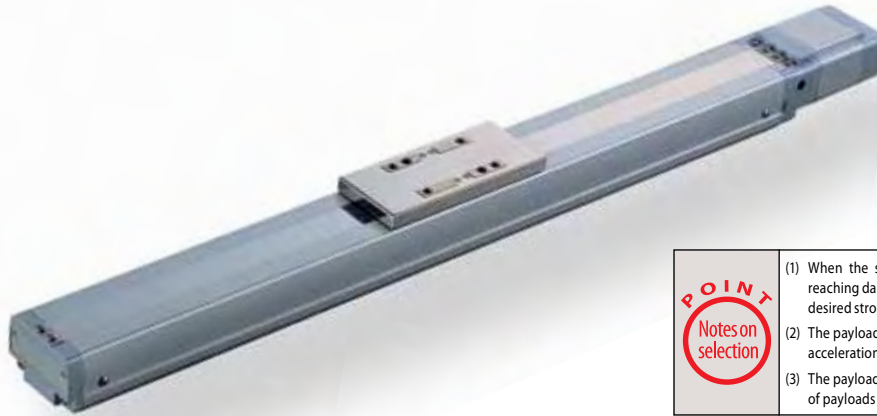

**POINT**  
Notes on selection

- (1) When the stroke is increased, the maximum speed will drop to prevent reaching dangerous speeds of ball screws. Confirm the maximum speed at the desired stroke by referring to the table of strokes and maximum speeds below.
- (2) The payload represents a value when the actuator is operated at a horizontal acceleration of 0.3 G (lead 5: 0.2 G) and vertical acceleration of 0.2 G.
- (3) The payload drops when the acceleration is raised. For details, refer to the list of payloads by acceleration provided on page 3.

## Actuator Specifications

### Lead and Payloads

Model number	Motor output (W)	Lead (mm)	Maximum payload		Rated thrust (N)	Stroke (mm)
			Horizontal (kg)	Vertical (kg)		
RCS3CR[RCS3PCR]-SS8C-①-100-30-②-③-④-⑤	100	30	8	2	56.6	50 to 1000 (every 50 mm)
RCS3CR[RCS3PCR]-SS8C-①-100-20-②-③-④-⑤		20	20	4	84.9	
RCS3CR[RCS3PCR]-SS8C-①-100-10-②-③-④-⑤		10	40	8	169.8	
RCS3CR[RCS3PCR]-SS8C-①-100-5-②-③-④-⑤		5	80	16	339.7	
RCS3CR[RCS3PCR]-SS8C-①-150-30-②-③-④-⑤	150	30	12	3	85.1	
RCS3CR[RCS3PCR]-SS8C-①-150-20-②-③-④-⑤		20	30	6	127.6	
RCS3CR[RCS3PCR]-SS8C-①-150-10-②-③-④-⑤		10	60	12	255.3	

Code explanation ① Encoder type ② Stroke ③ Applicable controller ④ Cable length ⑤ Option

### Stroke and Maximum Speed (unit: mm/s)

Stroke / Lead	50 to 600 (every 50 mm)	650	700	750	800	850	900	950	1000	Suction rate (NL/min)
30	1800	1660	1460	1295	1155	1035	935	850	775	160 (190)*
20	1200	1105	970	860	770	690	625	565	515	120
10	600	550	485	430	385	345	310	280	255	80
5	300	275	240	215	190	170	150	140	125	30

(\*): 160 NL/min if the speed is 1500 mm/s or below, or 190 NL/min if the speed exceeds 1500 mm/s.

### ① Encoder Type / ② Stroke

② Stroke (mm)	Standard Prices							
	RCS3CR-SS8C				RCS3PCR-SS8C			
	① Encoder Type				① Encoder Type			
	Incremental		Absolute		Incremental		Absolute	
	Motor wattage	Motor wattage	Motor wattage	Motor wattage	Motor wattage	Motor wattage	Motor wattage	Motor wattage
	100W	150W	100W	150W	100W	150W	100W	150W
50/100	-	-	-	-	-	-	-	-
150/200	-	-	-	-	-	-	-	-
250/300	-	-	-	-	-	-	-	-
350/400	-	-	-	-	-	-	-	-
450/500	-	-	-	-	-	-	-	-
550/600	-	-	-	-	-	-	-	-
650/700	-	-	-	-	-	-	-	-
750/800	-	-	-	-	-	-	-	-
850/900	-	-	-	-	-	-	-	-
950/1000	-	-	-	-	-	-	-	-

### ④ Cable Length

Type	Cable symbol	Standard price
Standard type	P (1m)	-
	S (3m)	-
	M (5m)	-
Special length	X06 (6m) ~ X10 (10m)	-
	X11 (11m) ~ X15 (15m)	-
	X16 (16m) ~ X20 (20m)	-
Robot cable	R01 (1m) ~ R03 (3m)	-
	R04 (4m) ~ R05 (5m)	-
	R06 (6m) ~ R10 (10m)	-
	R11 (11m) ~ R15 (15m)	-
	R16 (16m) ~ R20 (20m)	-

\* For the cables used for maintenance, refer to the back cover.

### ⑤ Options

Name	Option code	Page	Standard Prices
Cables exit from back left	A1E	→ P4	-
Cables exit from left side	A1S	→ P4	-
Cables exit from back right	A3E	→ P4	-
Cables exit from right side	A3S	→ P4	-
Brake	B	→ P4	-
Reversed-home specification	NM	→ P4	-
L-shaped suction joint specification	VL	→ P4	-

### Actuator Specifications RCS3PCR specifications are shown in [ ]. (Other items are the same.)

Item	Description
Drive method	Ball screw, Ø16 mm, rolled C10 [rolled C5]
Positioning repeatability	±0.02 mm [±0.01 mm]
Lost motion	0.1 mm [0.05 mm] max.
Base	Material: Dedicated alloy steel
Allowable static moment	Ma: 198.9 N·m Mb: 198.9 N·m Mc: 416.7 N·m
Allowable dynamic moment (*)	Ma: 36.3 N·m Mb: 36.3 N·m Mc: 77.4 N·m
Overhang load length	450 mm max. in Ma direction, 450 mm max. in Mb/Mc directions
Grease	Low dust-raising grease is used (for both the ball screw and guide).
Cleanliness class	Able to achieve cleanliness class 10 (0.1 µm).
Ambient operating temperature/humidity	0 to 40°C, 85% RH max. (No condensation)

(\*) When the traveling life is assumed as 10,000 km.

Direction of allowable load moment.

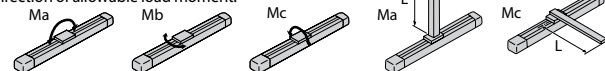



Diagram

CAD drawings are available for download from our website. Visit [www.intelligentactuator.com](http://www.intelligentactuator.com)



- \*1 Connect the motor/encoder cables. Refer to the back cover for details on cables.
- \*2 The slider moves to the ME during home return, so pay attention to potential contact with surrounding parts/structures.  
ME: Mechanical End SE: Stroke End
- \*3 Reference position used when calculating the Ma moment

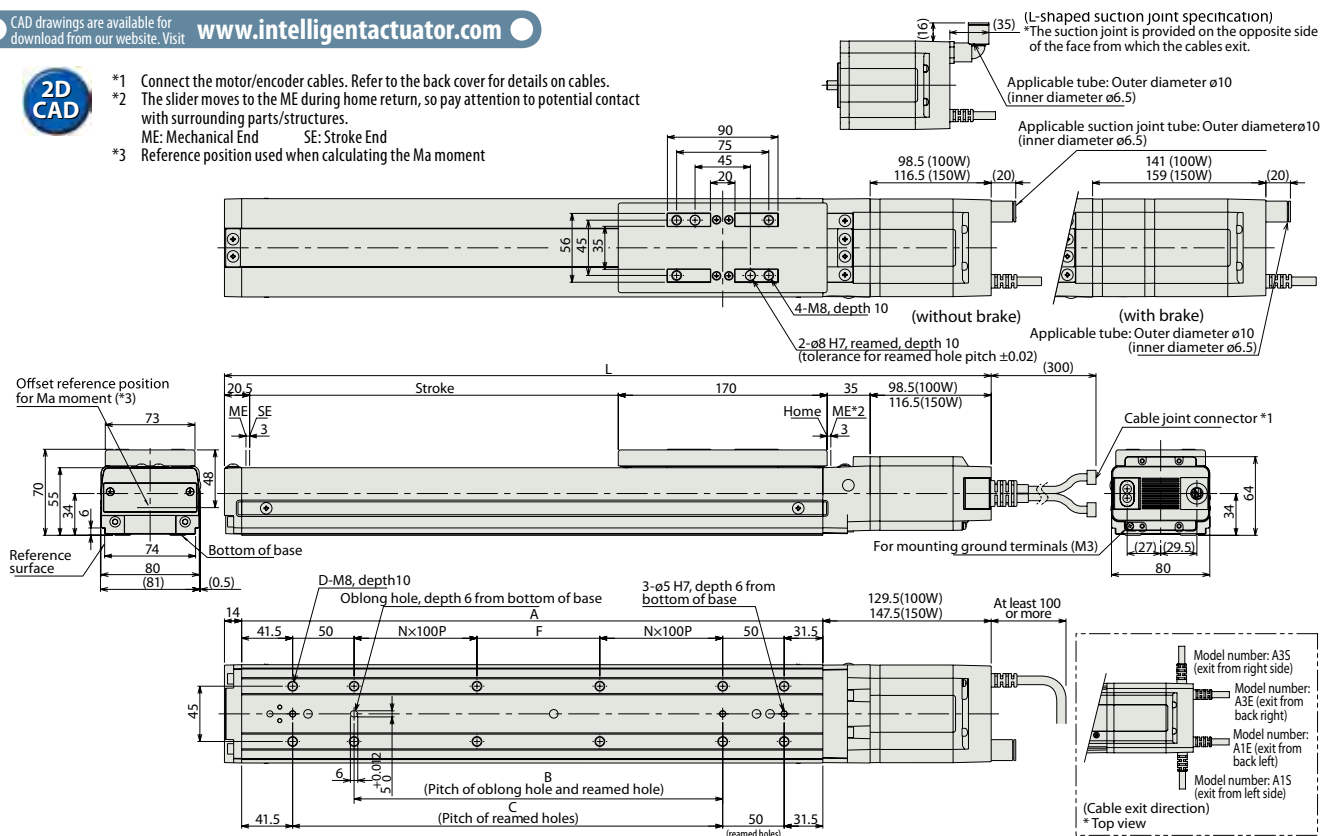

Dimensions and Weights by Stroke

L	Stroke	Stroke																				
		50	100	150	200	250	300	350	400	450	500	550	600	650	700	750	800	850	900	950	1000	
100W	without brake	374	424	474	524	574	624	674	724	774	824	874	924	974	1024	1074	1124	1174	1224	1274	1324	
	with brake	416.5	466.5	516.5	566.5	616.5	666.5	716.5	766.5	816.5	866.5	916.5	966.5	1016.5	1066.5	1116.5	1166.5	1216.5	1266.5	1316.5	1366.5	
150W	without brake	392	442	492	542	592	642	692	742	792	842	892	942	992	1042	1092	1142	1192	1242	1292	1342	
	with brake	434.5	484.5	534.5	584.5	634.5	684.5	734.5	784.5	834.5	884.5	934.5	984.5	1034.5	1084.5	1134.5	1184.5	1234.5	1284.5	1334.5	1384.5	
A		223	273	323	373	423	473	523	573	623	673	723	773	823	873	923	973	1023	1073	1123	1173	
B		50	100	150	200	250	300	350	400	450	500	550	600	650	700	750	800	850	900	950	1000	
C		100	150	200	250	300	350	400	450	500	550	600	650	700	750	800	850	900	950	1000	1050	
D		8	8	8	10	12	12	12	14	16	16	16	18	20	20	20	22	24	24	24	26	
F		50	100	150	0	50	100	150	0	50	100	150	0	50	100	150	0	50	100	150	0	
N		0	0	0	1	1	1	1	2	2	2	2	3	3	3	3	4	4	4	4	5	
Weight (kg)	100W	without brake	5.3	5.8	6.4	6.9	7.5	8.0	8.6	9.1	9.7	10.2	10.8	11.3	11.9	12.4	13.0	13.5	14.1	14.6	15.2	15.7
		with brake	5.7	6.2	6.8	7.3	7.9	8.4	9.0	9.5	10.1	10.6	11.2	11.7	12.3	12.8	13.4	13.9	14.5	15.0	15.6	16.1
	150W	without brake	5.3	5.9	6.4	7.0	7.5	8.1	8.6	9.2	9.7	10.3	10.8	11.4	11.9	12.5	13.0	13.6	14.1	14.7	15.2	15.8
		with brake	5.8	6.3	6.9	7.4	8.0	8.5	9.1	9.6	10.2	10.7	11.3	11.8	12.4	12.9	13.5	14.0	14.6	15.1	15.7	16.2

Applicable controllers

RCS3CR-series actuators can be operated with the following controllers. Select an appropriate controller type according to your application.

Name	External view	Model number	Features	Max # of positioning points	Input power supply	Power-supply capacity	Standard price	Page
Positioner mode		SCON-C-100①-NP-2-② SCON-C-150①-NP-2-②	Up to 512 positioning points are supported.	512 points	Single-phase 100VAC Single-phase 200VAC 3-phase 200 VAC (XSEL-P/Q only)	388 VA max. * 1-axis specification operated at 150 W	-	→ P17
Solenoid valve mode			Actuators can be operated through the same control used for solenoid valves.	7 points				
Serial communication type			Dedicated serial communication type	64 points				
Pulse-train input control type			Dedicated pulse-train input type	(-)				
Program control type, 1 to 2 axes		SSEL-C-1-100①-NP-2-② SSEL-C-1-150①-NP-2-②	Program operation is supported. Up to 2 axes can be operated.	20000 points				
Program control type, 1 to 6 axes		XSEL-③-1-100①-N1-EEE-2-④ XSEL-③-1-150①-N1-EEE-2-④	Program operation is supported. Up to 6 axes can be operated.	20000 points				





\* The information on SSEL and XSEL controllers are based on a 1-axis specification.  
 ① indicates the encoder type (I: Incremental / A: Absolute).  
 ② indicates the power-supply voltage type (1: 100 V / 2: Single-phase 200 V).  
 ③ indicates the XSEL type (I / K / P / Q).  
 ④ indicates the power-supply voltage type (1: 100 V / 2: Single-phase 200 V / 3: Three-phase 200 V).

## Applicable Controllers

RCS3, RCS3P, RCS3CR and RCS3PCR actuators can be operated with the controllers specified below.

Select a controller that meets the specification of your system.

\* For the details of each controller, refer to our General Catalog.

	Controller series/type	SCON	SSEL	XSEL	
				J/K type	P/Q type
Base specifications	Base specifications				
	Features	<ul style="list-style-type: none"> <li>A positioner controller supporting up to 512 positioning points.</li> <li>Actuators can be controlled not only by the positioner method, but also using pulse-train input.</li> </ul>	<ul style="list-style-type: none"> <li>A program controller capable of interpolation operation involving two axes.</li> <li>Although SSEL controllers are less scalable than XSEL controllers, they offer excellent cost performance.</li> </ul>	<ul style="list-style-type: none"> <li>A high-function controller capable of interpolation operation involving up to four axes.</li> <li>Can be operated with 100 VAC.</li> </ul>	<ul style="list-style-type: none"> <li>A high-function controller capable of interpolation operation involving up to six axes.</li> <li>Multiple actuators can be connected up to a maximum output of 2400 W.</li> </ul>
	Power-supply capacity	100W/282VA 150W/376VA	100W/294VA 150W/388VA (The above capacities are based on a 1-axis specification.)	The specific capacities vary depending on the specification. Contact IAI for details.	
	Input power supply	Single-phase 100 VAC Single-phase 200 VAC	Single-phase 100 VAC Single-phase 200 VAC	Single-phase 100 VAC Single-phase 200 VAC	Single-phase 200 VAC Three-phase 200 VAC
	Operating power-supply voltage range	±10%			
Control specifications	Total output of maximum number of connected axes (W)	200 W (100-V power-supply specification) 750 W (200-V power-supply specification)	400 W (100-V power-supply specification) 800 W (200-V power-supply specification)	400 W (XSEL-J single-phase 100 V) 800 W (XSEL-K single-phase 100 V)	1600 W (single-phase 200 V) 2400 W (three-phase 200 V)
	Maximum number of controlled axes	1 axis	2 axes	4 axes	6 axes
	Position detection type	Incremental encoder/absolute encoder			
	Operation type	Positioner operation Pulse-train control	Program operation Positioner operation (switchable)	Program operation	
Program	Program language	–	Super SEL language		
	Number of programs	–	128	64	128
	Number of program steps	–	9999	6000	9999
	Number of multi-tasking programs	–	8	16	16
	Number of positions	Up to 512	20000	3000	20000
	Data input device (option)	Teaching pendant Model number: CON-PT/CON-T RCM-E/RCM-P PC software Model number: RCM-101-MW (for RS232 communication) RCM-101-USB (for USB communication)	Teaching pendant Model number: SEL-T-J SEL-TD-J PC software Model number: IA-101-X-MW-J (for RS232 communication) IA-101-X-USB (for USB communication)	Teaching pendant Model number: IA-T-X/XD (common to XSEL-J/K) SEL-T/TD/TG (for XSEL-K) PC software Model number: IA-101-X-MW (for RS232 communication) IA-101-X-USBMW (for USB communication)	Teaching pendant Model number: SEL-T/TD/TG PC software Model number: IA-101-X-MW IA-101-X-USBMW (for XSEL-P) IA-101-XA-MW (for XSEL-Q)
I/O, communication	Standard I/Os	16 input points/16 output points (NPN/PNP selectable)	24 input points/8 output points (NPN/PNP selectable)	32 input points/16 output points (NPN/PNP selectable)	
	Extended I/Os	Not supported		Total input/output points: 80 (XSEL-J) Total input/output points: 336 (XSEL-K)	Total input/output points: 384
	Field network	DeviceNet, CC-Link, Profibus, Ethernet			
Operating environment	Operating ambient temperature/humidity	0 to 40°C, 10 to 95% (no condensation)			
	Operating ambience	Free from corrosive gases and too much powder dust.			
	External dimensions	56 (W) x 200.5 (H) x 121 (D) (200 W or less) 72 (W) x 200.5 (H) x 121 (D) (400 W or more)	100 (W) x 202.6 (H) x 126 (D) (absolute battery installed)	159.4 (W) x 195 (H) x 125.3 (D) (XSEL-J 1-axis specification) 369.4 (W) x 195 (H) x 125.3 (D) (XSEL-K 1-axis specification)	265 (W) x 195 (H) x 125.3 (D) (XSEL-P 1-axis specification) 222 (W) x 195 (H) x 125.3 (D) (XSEL-Q 1-axis specification)
	Weight	1.1kg	1.4kg	2.6kg (XSEL-J) 6.0kg (XSEL-K)	5.2kg (XSEL-P) 4.5kg (XSEL-Q)
	Accessory	I/O flat cable (40-core)	I/O flat cable (34-core)	I/O flat cable (50-core)	

# System Configuration

## ■ Connecting a SCON Controller

**Note**

A regenerative resistance unit may be needed depending on the actuator(s) operated by the controller. For details, refer to our General Catalog.



**Actuator**

Motor cable  
Model number: CB-RCC-MA□□□□  
Model number: CB-RCC-MA□□□□-RB  
(Comes with the actuator)

Encoder cable  
Model number: CB-RCS2-PA□□□□  
Model number: CB-X3-PA□□□□  
(Comes with the actuator)

**Main power**

Single-phase 100 VAC  
Single-phase 200 VAC



I/O flat cable  
Model number: CB-PAC-PI0020  
Standard 2 m (Comes with the controller)

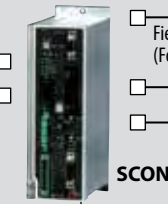

**SCON**

Field network (option)  
(For details, refer to our General Catalog.)

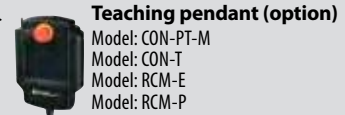

**Teaching pendant (option)**

Model: CON-PT-M  
Model: CON-T  
Model: RCM-E  
Model: RCM-P



**PC**

**PC software (option)**

RS232 connection type  
Model number: RCM-101-MW  
USB connection type  
Model number: RCM-101-USB

\* Be sure to use a noise filter for the power supply. (For the recommended models of noise filters, refer to our General Catalog.)

## ■ Connecting a SSEL Controller

**Note**

A regenerative resistance unit may be needed depending on the actuator(s) operated by the controller. For details, refer to our General Catalog.



**Actuator**

Motor cable  
Model number: CB-RCC-MA□□□□  
Model number: CB-RCC-MA□□□□-RB  
(Comes with the actuator)

Encoder cable  
Model number: CB-RCS2-PA□□□□  
Model number: CB-X3-PA□□□□  
(Comes with the actuator)

**Main power**

Single-phase 100 VAC  
Single-phase 200 VAC



I/O flat cable  
Model number: CB-PAC-PI0020  
Standard 2 m (Comes with the controller)



**SSEL**

Field network (option)  
(For details, refer to our General Catalog.)



**Teaching pendant (option)**

Model: SEL-T-J  
Model: SEL-TD-J  
Model: IA-T-X-J  
Model: IA-T-XD-J



**PC**

**PC software (option)**

RS232 connection type  
Model number: IA-101-X-MW-J  
USB connection type  
Model number: IA-101-X-USB

\* Be sure to use a noise filter for the power supply. (For the recommended models of noise filters, refer to our General Catalog.)

## ■ Connecting a XSEL-J/K Controller

**Note**

A regenerative resistance unit may be needed depending on the actuator(s) operated by the controller. For details, refer to our General Catalog.



**Actuator**

Motor cable  
Model number: CB-RCC-MA□□□□  
Model number: CB-RCC-MA□□□□-RB  
(Comes with the actuator)

Encoder cable  
Model number: CB-RCBC-PA□□□□  
Model number: CB-RCBC-PA□□□□-RB  
(Comes with the actuator)

**Main power**

Single-phase 100 VAC  
Single-phase 200 VAC



I/O flat cable  
Model number: CB-X-PI0020  
Standard 2 m (Comes with the controller)



**XSEL-J/K**

Field network (option)  
(For details, refer to our General Catalog.)



**Teaching pendant (option)**

Model: IA-T-X  
Model: IA-T-XD  
Model: SEL-T  
Model: SEL-TD  
\* SEL-T/SEL-TD teaching pendants cannot be used with X-SEL-J controllers.



**PC**

**PC software (option)**

RS232 connection type  
Model number: IA-101-X-MW  
USB connection type  
Model number: IA-101-X-USBMW

\* Be sure to use a noise filter for the power supply. (For the recommended models of noise filters, refer to our General Catalog.)

## ■ Connecting a XSEL-P/Q Controller

**Note**

A regenerative resistance unit may be needed depending on the actuator(s) operated by the controller. For details, refer to our General Catalog.



**Actuator**

Motor cable  
Model number: CB-RCC-MA□□□□  
Model number: CB-RCC-MA□□□□-RB  
(Comes with the actuator)

Encoder cable  
Model number: CB-RCS2-PA□□□□  
Model number: CB-X3-PA□□□□  
(Comes with the actuator)

**Main power**

Single-phase 200 VAC  
Three-phase 200 VAC



I/O flat cable  
Model number: CB-X-PI0020  
Standard 2 m (Comes with the controller)



**XSEL-P/Q**

Field network (option)  
(For details, refer to our General Catalog.)



**Teaching pendant (option)**

Model: SEL-T  
Model: SEL-TD  
Model: IA-T-X  
Model: IA-T-XD



**PC**

**PC software (option)**

RS232 connection type  
Model number: IA-101-X-MW  
USB connection type  
Model number: IA-101-X-USBMW

\* Be sure to use a noise filter for the power supply. (For the recommended models of noise filters, refer to our General Catalog.)

## Service Parts

Refer to the model numbers below if you need to purchase any of these parts for cable replacement, etc., after purchasing your product.

### Motor cable/ Motor robot cable

Model number **CB-RCC-MA**□□□/ **CB-RCC-MA**□□□-**RB**

\* □□□ indicates the cable length (L). A desired length can be specified up to 20 m. Example: 080 = 8 m

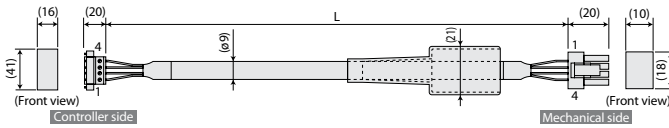

Minimum bending radius  
 $r = 50$  mm min.  
 (When movable cables are used)  
 \* Only robot cables can be used in cable tracks.

Wiring	Signal	No.	No.	Signal	Wiring
0.75sq	PE	1	1	U	0.75sq (Crimped)
	U	2	2	V	
	V	3	3	W	
	W	4	4	PE	

### Encoder cable/ Encoder robot cable (XSEL-J/K types)

Model number **CB-RCBC-PA**□□□/ **CB-RCBC-PA**□□□-**RB**

\* □□□ indicates the cable length (L). A desired length can be specified up to 15 m. Example: 080 = 8 m

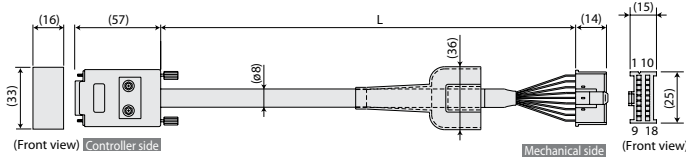

Minimum bending radius  $r = 50$  mm min. (When movable cables are used)  
 \* Only robot cables can be used in cable tracks.

Wiring	Signal	No.	No.	Signal	Wiring
0.15sq (Crimped)	A/U	1	1	A/U	0.15sq (Crimped)
	A/U	2	2	A/U	
	B/V	3	3	B/V	
	B/V	4	4	B/V	
	Z/W	5	5	Z/W	
	Z/W	6	6	Z/W	
	SD	7	7	—	
	SD	8	8	—	
	BAT+	9	9	FG	
	BAT-	10	10	SD	
	VCC	11	11	SD	
	GND	12	12	BAT+	
	BK-	13	13	BAT-	
	BK+	14	14	VCC	
	—	15	15	GND	
	—	16	16	—	
	—	17	17	BK-	
	—	18	18	BK+	

Connect the shield to the hood via a clamp.  
 Ground wire and braided wire shield

### Encoder cable/ Encoder robot cable (SCON/SSEL/XSEL-P/Q types)

Model number **CB-RCS2-PA**□□□/ **CB-X3-PA**□□□

\* □□□ indicates the cable length (L). A desired length can be specified up to 20 m. Example: 080 = 8 m

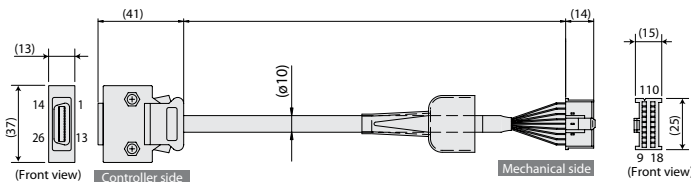

Minimum bending radius  $r = 50$  mm min. (When movable cables are used)  
 \* Only robot cables can be used in cable tracks.

Wiring	Color	Signal	No.	No.	Signal	Color	Wiring
AWG26 (Soldered)	—	—	10	1	A	Pink	AWG26 (Crimped)
	—	—	11	2	A	Purple	
	—	E24V	12	3	B	White	
	Gray/white	OV	13	4	B	Blue/red	
	Brown/white	LS	26	5	Z	Orange/white	
	—	CREEP	25	6	Z	Green/white	
	—	OT	24	7	LS+	Brown/white	
	—	RSV	23	8	—	—	
	—	—	9	9	FG	Ground	
	—	—	18	10	SD	Blue	
	—	—	19	11	SD	Orange	
	Pink	A+	1	12	BAT+	Black	
	Purple	A-	2	13	BAT-	Yellow	
	White	B+	3	14	VCC	Green	
	Blue/red	B-	4	15	GND	Brown	
	Orange/white	Z+	5	16	LS-	Gray/white	
	Green/white	Z-	6	17	BK-	Gray	
	Blue	SRD+	7	18	BK+	Red	
	Orange	SRD-	8	—	—	—	
	Black	BAT+	14	—	—	—	
	Yellow	BAT-	15	—	—	—	
	Green	VCC	16	—	—	—	
Brown	GND	17	—	—	—		
Gray	BKR+	20	—	—	—		
Red	BKR-	21	—	—	—		
—	—	22	—	—	—		

Connect the shield to the hood via a clamp.  
 Ground wire and braided wire shield