

Long Stroke Gripper **RCP6(S)-GRST**

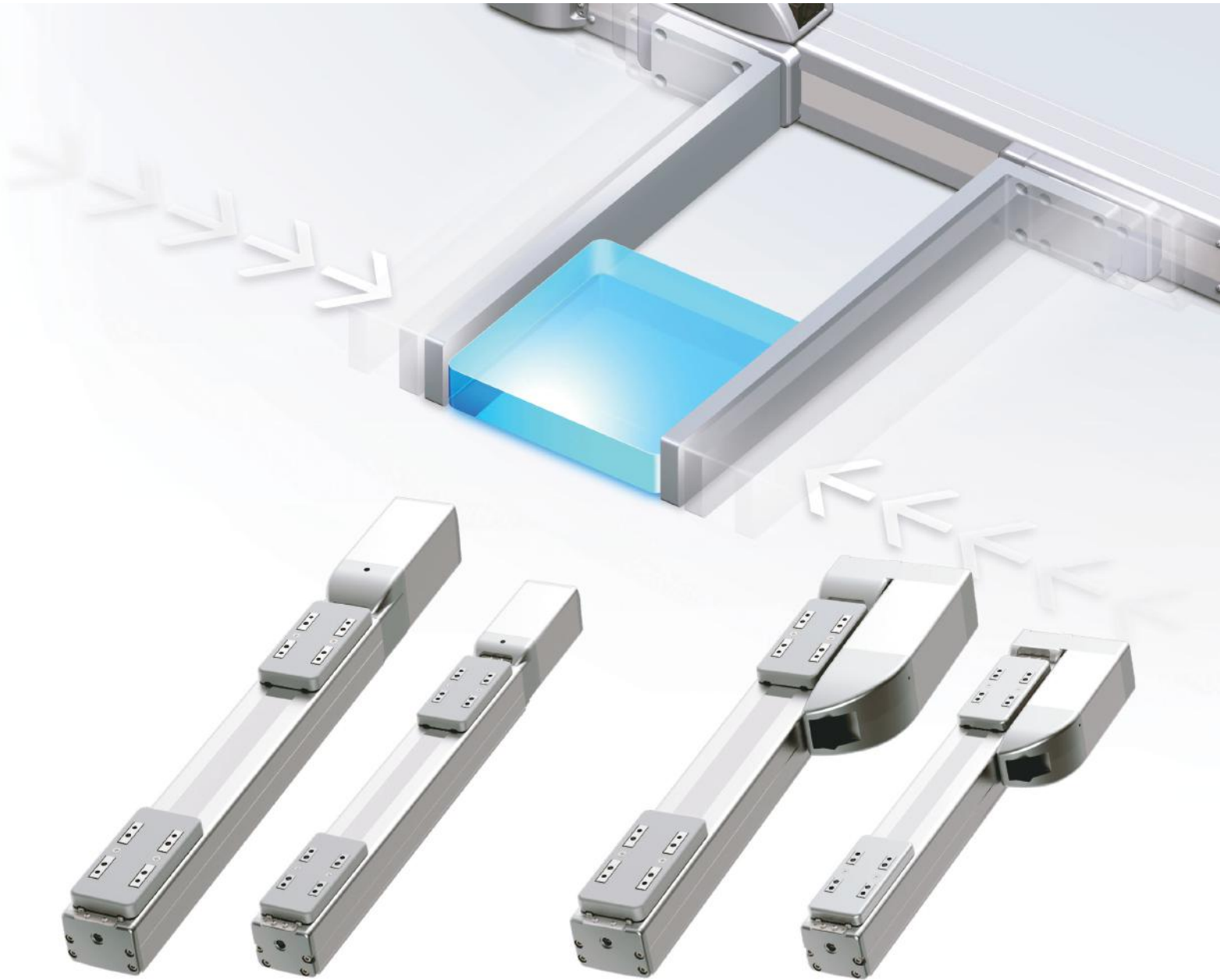

Long stroke and high grip force

Long stroke gripper is ideal for grasping large workpieces.

1. Long stroke provides high rigidity

- A long stroke type with maximum opening/closing stroke of 260mm (130mm per side).

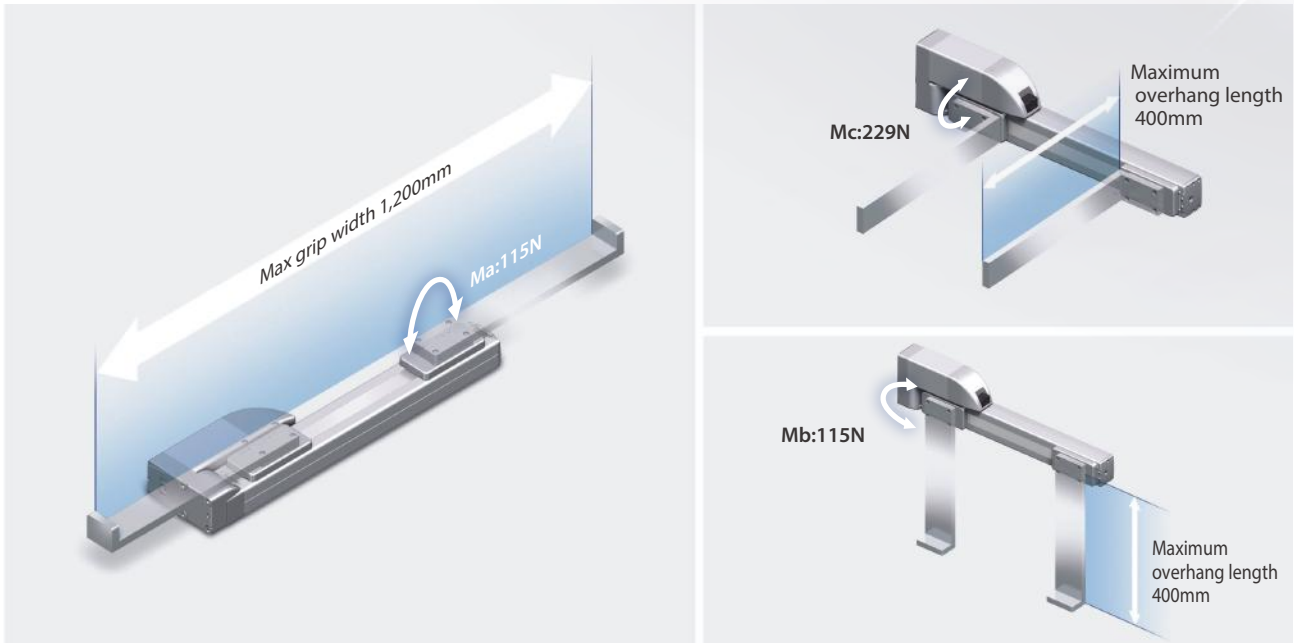

2. High grip force of up to 440N

The grip force can be adjusted according to the workpiece.

* Grip force per side of the slider

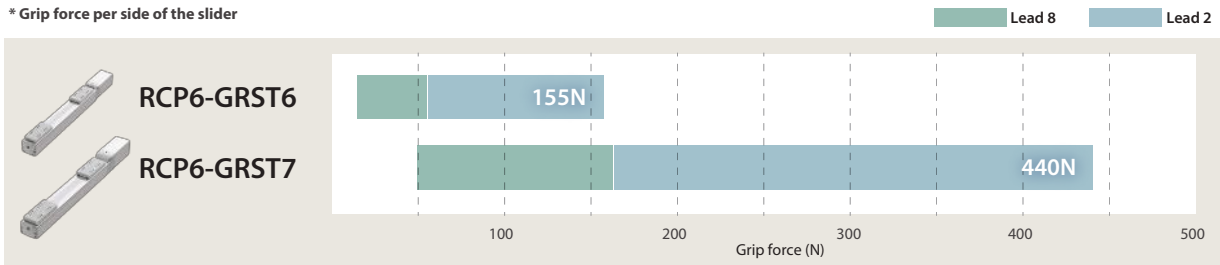

3. Equipped with a Battery-less Absolute Encoder as standard

Since the home position is stored even when the power is turned off and on again, home return is not required. You can move to the next operation while gripping the workpiece.

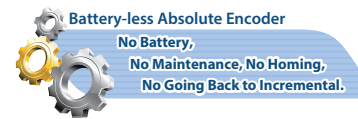





4. Built-in controller type available

Types without controller (RCP6) and with built-in controller (RCP6S) are available.

Advantages
of built-in
controller type

- Smaller control panel.
- Simple wiring.

Type	Coupling type				Side-mounted motor type			
Model	RCP6(S)-GRST6C		RCP6(S)-GRST7C		RCP6(S)-GRST6R		RCP6(S)-GRST7R	
External view								
Opening/closing stroke [mm]	180/230		210/260		180/230		210/260	
Ball screw lead [mm]	8	2	8	2	8	2	8	2
Maximum opening/closing speed [mm/s]	180 (per side)	45 (per side)	180 (per side) (Note)	45 (per side)	180 (per side)	45 (per side)	180 (per side) (Note)	45 (per side)
Max grip force [N]	55 (per side)	155 (per side)	170 (per side)	440 (per side)	55 (per side)	155 (per side)	170 (per side)	440 (per side)
Positioning repeatability [mm]	±0.01							
Reference page	P3		P7		P11		P15	

Note: 140 per side when operating ambient temperature is 5°C or below

Explanation of Model Specification Items

RCP6
RCP6S

Series

RCP6	Separate controller
RCP6S	Built-in controller

Type

GRST6C	Body width 60mm Coupled type
GRST7C	Body width 70mm Coupled type
GRST6R	Body width 60mm Side-mounted motor type
GRST7R	Body width 70mm Side-mounted motor type

Encoder Type

WA	Battery-less Absolute
----	-----------------------

Motor Type

42P	42□ Stepper motor
56P	56□ Stepper motor

Ball screw lead

2	Lead 2mm
8	Lead 8mm

Stroke

180	180mm (90mm per side)
210	210mm (105mm per side)
230	230mm (115mm per side)
260	260mm (130mm per side)

Applicable Controllers (RCP6)

P3	PCON-CB/CGB PCON-CYB/PLB/POB MCON-C/CG-LC/LCG MSEL-PC/PG
P5	RCM-P6PC RCON

I/O Type (RCP6S)

SE	SIO type
----	----------

Cable Length

N	None
P	1m
S	3m
M	5m
X□□	Specified length
R□□	Robot cable

Options

B	Brake
CJT	Cable exit direction (Top)
CJR	Cable exit direction (Right)
CJL	Cable exit direction (Left)
CJB	Cable exit direction (Bottom)
CJO	Cable exit direction (Outside)
MJF	Finger attachment mounting jig
ML	Motor side-mounted to left spec.
MR	Motor side-mounted to right spec.
NM	Non-motor end specification
SR	Slider roller specification
SS	Slider spacer

* When RCP6 (separate controller type) is selected, pick a code for the applicable controller, and when RCP6S (built-in controller type) is selected, pick a code for the I/O type.

* The type of motor, ball screw lead, stroke, and selection options vary depending on the actuator type. Please refer to the pages of each type for details.

RCP6-GRST6C

RCP6S-GRST6C

±10µm
Simple Dustproof
Battery-less Absolute
Slide Type
2-finger
Coupled Motor
Body Width 60mm
24v Stepper Motor

Model Specification Items

GRST6C		WA		42P											
Series		Encoder type		Motor type		Lead		Stroke		Applicable controllers / I/O type		Cable length		Options	
RCP6 Separate controller		WA Battery-less Absolute		42P Stepper motor 42□ size		8 8mm	2 2mm	180 180mm (90mm per side)	230 230mm (115mm per side)	RCP6	P3 PCON MCON MSEL		N None	Refer to Options table below.	
RCP6S Built-in controller										P5 RCM-P6PC RCON	X□□ Specified length R□□ Robot cable				
										RCP6S					
										SE SIO type					



CE
RoHS

Horizontal
Vertical
Side
Ceiling

Stroke		
Stroke (mm)	RCP6	RCP6S
180	<input type="checkbox"/>	<input type="checkbox"/>
230	<input type="checkbox"/>	<input type="checkbox"/>

Option		
Name	Option code	Reference page
Brake	B	See P.21
Cable exit direction (Top)	CJT	See P.21
Cable exit direction (Right)	CJR	See P.21
Cable exit direction (Left)	CJL	See P.21
Cable exit direction (Bottom)	CJB	See P.21
Finger attachment mounting jig	MJF	See P.21
Non-motor end specification	NM	See P.22
Slider Roller Specification	SR	See P.22

Cable Length				
Type	Cable code	RCP6-GRST6C		RCP6S-GRST6C
		P3	P5	SE
Standard type	P (1m)	<input type="checkbox"/>	<input type="checkbox"/>	<input type="checkbox"/>
	S (3m)	<input type="checkbox"/>	<input type="checkbox"/>	<input type="checkbox"/>
	M (5m)	<input type="checkbox"/>	<input type="checkbox"/>	<input type="checkbox"/>
Specified length	X06 (6m) ~ X10 (10m)	<input type="checkbox"/>	<input type="checkbox"/>	<input type="checkbox"/>
	X11 (11m) ~ X15 (15m)	<input type="checkbox"/>	<input type="checkbox"/>	<input type="checkbox"/>
	X16 (16m) ~ X20 (20m)	<input type="checkbox"/>	<input type="checkbox"/>	<input type="checkbox"/>
Robot cable	R01 (1m) ~ R03 (3m)	<input type="checkbox"/>	<input type="checkbox"/>	<input type="checkbox"/>
	R04 (4m) ~ R05 (5m)	<input type="checkbox"/>	<input type="checkbox"/>	<input type="checkbox"/>
	R06 (6m) ~ R10 (10m)	<input type="checkbox"/>	<input type="checkbox"/>	<input type="checkbox"/>
	R11 (11m) ~ R15 (15m)	<input type="checkbox"/>	<input type="checkbox"/>	<input type="checkbox"/>
	R16 (16m) ~ R20 (20m)	<input type="checkbox"/>	<input type="checkbox"/>	<input type="checkbox"/>

* Please contact IAI for more information regarding the maintenance cables.

POINT Selection Notes

- (1) The maximum opening/closing speed indicates the operating speed per side. The relative operating speed is twice this value.
- (2) The maximum grip force is the total value of both slider grip forces for the slider top surface (gripping position: 0mm, overhang amount: 0mm).
- (3) The maximum acceleration/deceleration while moving is 0.3G.
- (4) The fluctuation in grip force is ±25% (F.S.) (guideline).
- (5) The guideline for the overhang load length is 300mm or less in the Ma, Mb and Mc directions.
- (6) The self-locking function allows Lead 2 to maintain workpiece grip force even when the servo is turned off or the controller power supply is cut off. Lead 8 does not have a self-locking function.

Main Specifications

Item	Description	
Lead	Lead screw (mm)	8 2
	Max grip force (N)	110 (55 per side) 310 (155 per side)
Grip	Max speed while gripping (mm/s)	10 5
	Max speed (mm/s)	180 (per side) 45 (per side)
Speed / acceleration/ deceleration	Min speed (mm/s)	10 (per side) 5 (per side)
	Max. acceleration/deceleration (G)	0.3 0.3
Brake (option)	Brake specifications	Non-excitation actuated electromagnetic brake
	Brake retention force (kgf)	5.5 -
Opening/closing stroke	Min. stroke (mm)	180 (90 per side) 180 (90 per side)
	Max. stroke (mm)	230 (115 per side) 230 (115 per side)

Item	Description
Drive system	Left/right trapezoidal screw
Positioning repeatability	±0.01mm
Backlash	Lead 8mm: 0.3mm or less per side, Lead 2mm: 0.25mm or less per side
Lost motion	Lead 8mm: 0.3mm or less per side, Lead 2mm: 0.25mm or less per side
Linear guide	Direct-acting infinite circulation type
Allowable static moment	Ma: 48N-m
	Mb: 69N-m
	Mc: 103N-m
Allowable dynamic moment (Note 1)	Ma: 11N-m
	Mb: 16N-m
	Mc: 24N-m
Ambient operating temp. & humidity	0 to 40°C, 85% RH or less (Non-condensing)
Degree of protection	IP20
Vibration resistance / shock resistance	4.9m/s ² 100Hz or less
Compliant international standards	CE marking, RoHS Directive
Encoder type	Battery-less Absolute Encoder
Encoder pulse count	8192 pulse/rev

(Note 1) Assumes a standard rated life of 5,000km. The running life will vary depending on operation and installation conditions. Please contact IAI for the running life.

Slider Type Moment Direction

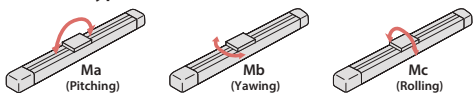

Stroke and Max Speed

Lead (mm)	Stroke	180 (mm)	230 (mm)
	8		180
2		45	

(Unit: mm/s)

Gripping Force vs Electric Current Limit

The gripping (pushing) force can be adjusted freely within the range of electric current limits of 30% to 70%.

* For L1 and L2, refer to the "Gripper selection method" on P.19.

The grip force in the graph below assumes that L1 and L2 in the figure at left are zero. Grip force is the sum of both fingers.

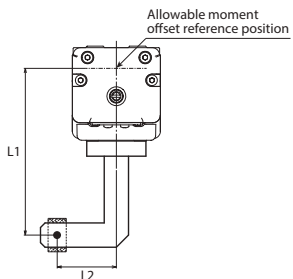

Lead 8

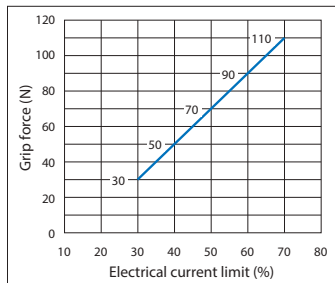

Lead 2

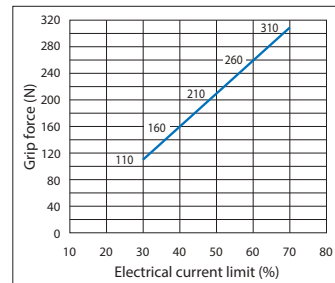

RCP6-GRST6C

- *1 When the sliders are returning to their home position, please be careful of interference from surrounding objects, as both the sliders will travel until they reach the M.E.
- * Both sliders simultaneously operate in opposite directions.

ST: Stroke
M.E: Mechanical end
S.E: Stroke end

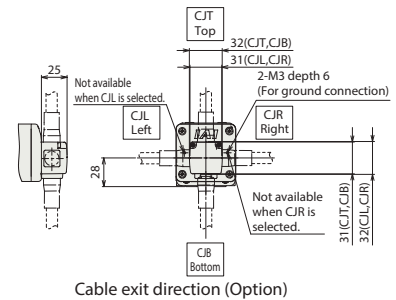
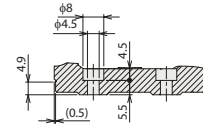
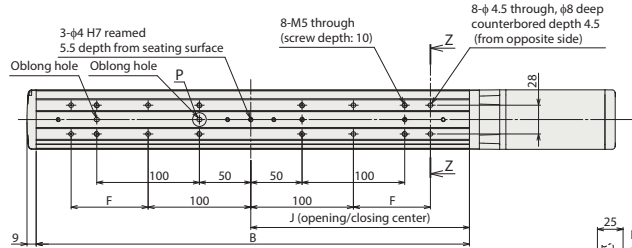
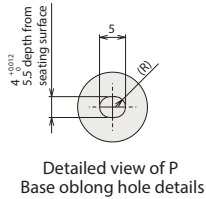
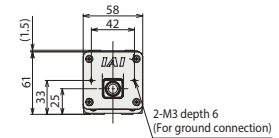
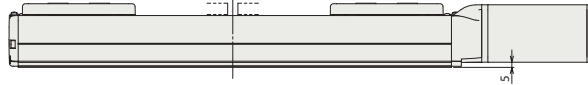
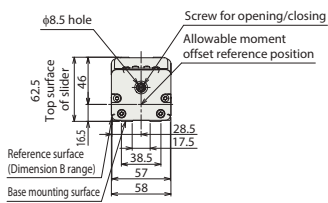
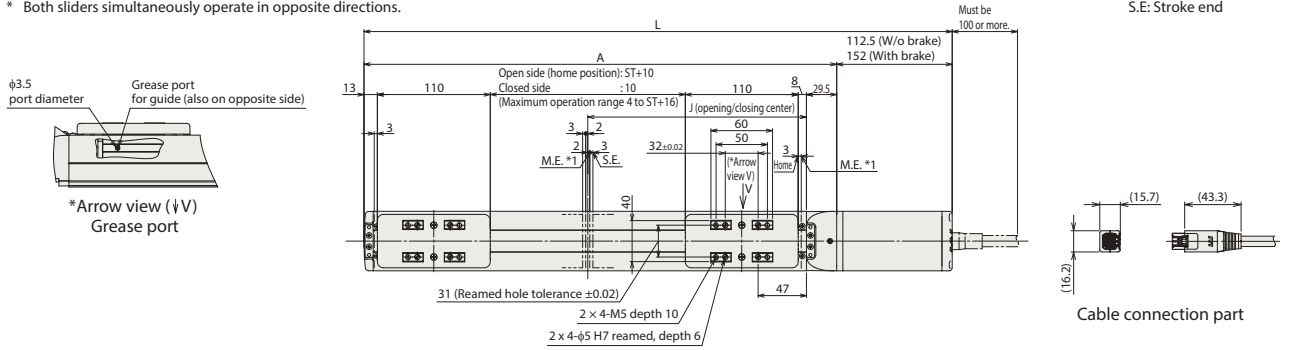

Dimensions by Stroke

L	Stroke		180	230
		W/o Brake	With Brake	573
	A	B	460.5	510.5
	F	J	75	100
			213	238

Mass by Stroke

Mass (kg)	RCP6	Stroke		180	230
			W/o Brake	With Brake	3.2
				3.4	3.6

■ RCP6S-GRST6C

*1 When the sliders are returning to their home position, please be careful of interference from surrounding objects, as both the sliders will travel until they reach the M.E.
 * Both sliders simultaneously operate in opposite directions.

ST: Stroke
 M.E: Mechanical end
 S.E: Stroke end

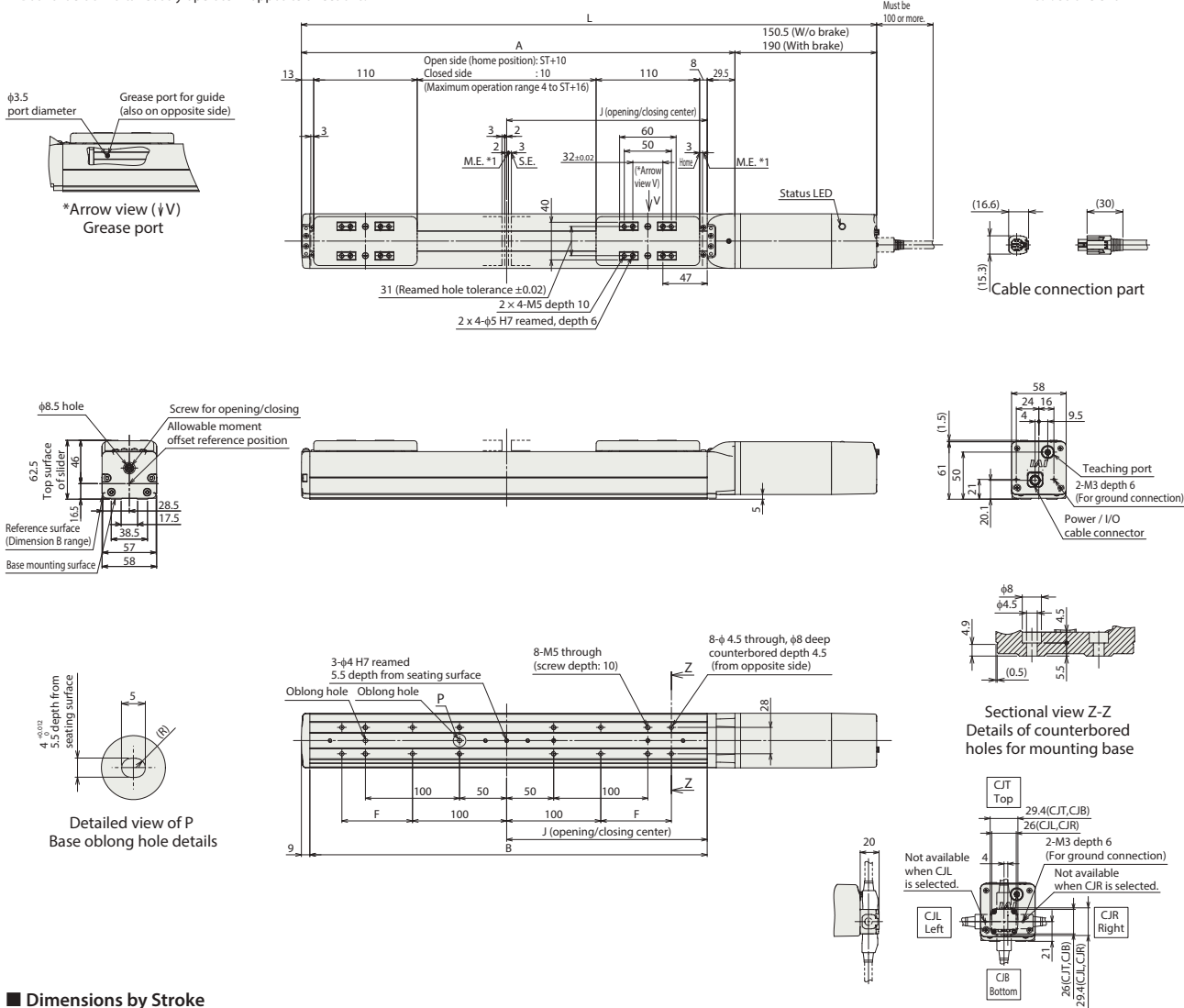

■ Dimensions by Stroke

L	Stroke		180	230
	W/o Brake	With Brake	611	661
A		460.5	510.5	
B		422	472	
F		75	100	
J		213	238	

■ Mass by Stroke

Mass (kg)	RCP6S	Stroke		180	230
		W/o Brake	With Brake	3.3	3.5

Applicable Controllers

The actuators on this page can be operated by the controllers indicated below. Please select the type depending on your intended use.

Name	External view	Max. number of connectable axes	Power supply voltage	Control method														Maximum number of positioning points	Reference page
				Positioner	Pulse-train	Program	Network option *1												
				DV	CC	CIE	PR	CN	ML	ML3	EC	EP	PRT	SSN	ECM				
MCON-C/CG		8	24VDC	-	-	-	●	●	-	●	●	-	●	●	●	●	256	Please contact IAI for more information.	
MCON-LC/LCG		6		-	-	●	●	-	●	●	-	-	●	●	-	-	256		
MSEL-PC/PG		4	Single phase 100~230VAC	-	-	●	●	-	-	-	-	●	●	-	-	30000			
PCON-CB/CGB		1	24VDC	● * Option	● * Option	-	●	●	-	●	●	●	●	-	-	512 (768 for network spec.)			
PCON-CYB/PLB/POB		1		● * Option	● * Option	-	-	-	-	-	-	-	-	-	-	64			
RCM-P6PC		1	Can be used within the RCP6S Gateway system.													768			
RCON		16	24VDC	-	-	-	●	●	●	●	-	-	●	●	-	128	RCON pamphlet		

*1 For network abbreviations such as DV and CC, please contact IAI.
 * For the RCP6S Series built-in controller, please contact IAI.

RCP6-GRST7C

RCP6S-GRST7C



Simple Dustproof

Battery-less Absolute

Slide Type

2-finger

Coupled Motor

Body Width
70 mm

24v Stepper Motor

Model Specification Items

Series		Type		Encoder type		Motor type		Lead		Stroke		Applicable controllers / I/O type		Cable length		Options	
RCP6	Separate controller	GRST7C		WA	Battery-less Absolute	56P	Stepper motor 56□ size	8	8mm	210	210mm (105mm per side)	RCP6		N	None	Refer to Options table below.	
RCP6S	Built-in controller							2	2mm	260	260mm (130mm per side)	P3	PCON MCON MSEL	P	1m		
												P5	RCM-P6PC RCON	S	3m		
														M	5m		
														X	Specified length		
														R	Robot cable		
												RCP6S					
												SE	SIO type				

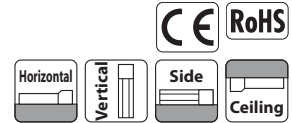

Stroke

Stroke (mm)	RCP6	RCP6S
210	<input type="checkbox"/>	<input type="checkbox"/>
260	<input type="checkbox"/>	<input type="checkbox"/>

Option

Name	Option code	Reference page
Brake	B	See P.21
Cable exit direction (Top)	CJT	See P.21
Cable exit direction (Right)	CJR	See P.21
Cable exit direction (Left)	CJL	See P.21
Cable exit direction (Bottom)	CJB	See P.21
Finger attachment mounting jig	MJF	See P.21
Non-motor end specification	NM	See P.22
Slider roller specification	SR	See P.22

Cable Length

Type	Cable code	RCP6-GRST7C		RCP6S-GRST7C
		P3	P5	SE
Standard type	P(1m)	<input type="checkbox"/>	<input type="checkbox"/>	<input type="checkbox"/>
	S(3m)	<input type="checkbox"/>	<input type="checkbox"/>	<input type="checkbox"/>
	M(5m)	<input type="checkbox"/>	<input type="checkbox"/>	<input type="checkbox"/>
Specified length	X06(6m) ~ X10(10m)	<input type="checkbox"/>	<input type="checkbox"/>	<input type="checkbox"/>
	X11(11m) ~ X15(15m)	<input type="checkbox"/>	<input type="checkbox"/>	<input type="checkbox"/>
	X16(16m) ~ X20(20m)	<input type="checkbox"/>	<input type="checkbox"/>	<input type="checkbox"/>
Robot cable	R01(1m) ~ R03(3m)	<input type="checkbox"/>	<input type="checkbox"/>	<input type="checkbox"/>
	R04(4m) ~ R05(5m)	<input type="checkbox"/>	<input type="checkbox"/>	<input type="checkbox"/>
	R06(6m) ~ R10(10m)	<input type="checkbox"/>	<input type="checkbox"/>	<input type="checkbox"/>
	R11(11m) ~ R15(15m)	<input type="checkbox"/>	<input type="checkbox"/>	<input type="checkbox"/>
	R16(16m) ~ R20(20m)	<input type="checkbox"/>	<input type="checkbox"/>	<input type="checkbox"/>

* Please contact IAI for more information regarding the maintenance cables.

POINT Selection Notes

- (1) The maximum opening/closing speed indicates the operating speed per side. The relative operating speed is twice this value.
- (2) The maximum grip force is the total value of both slider grip forces for the slider top surface (gripping position: 0mm, overhang amount: 0mm).
- (3) The maximum acceleration/deceleration while moving is 0.3G.
- (4) The fluctuation in grip force is ±25% (F.S.) (guideline).
- (5) The guideline for the overhang load length is 300mm or less in the Ma, Mb and Mc directions.
- (6) The self-locking function allows Lead 2 to maintain workpiece grip force even when the servo is turned off or the controller power supply is cut off. Lead 8 does not have a self-locking function.

Main Specifications

Item	Description	
Lead	Lead screw (mm)	8 2
	Max grip force (N)	340 (170 per side) 880 (440 per side)
Grip	Max speed while gripping (mm/s)	10 5
	Max. speed (mm/s) (Note 1)	180 (per side) <140 (per side)> 45 (per side)
Speed / acceleration/ deceleration	Min speed (mm/s)	10 (per side) 5 (per side)
	Max. acceleration/deceleration (G)	0.3 0.3
Brake (option)	Brake specifications	Non-excitation actuated electromagnetic brake
	Brake retention force (kgf)	17 -
Opening/closing stroke	Min. stroke (mm)	210 (105 per side) 210 (105 per side)
	Max. stroke (mm)	260 (130 per side) 260 (130 per side)

(Note 1) Value in brackets < > is where the operating ambient temperature is 5°C or below.

Item	Description
Drive system	Left/right trapezoidal screw
Positioning repeatability	±0.01mm
Backlash	Lead 8mm: 0.3mm or less per side, Lead 2mm: 0.25mm or less per side
Lost motion	Lead 8mm: 0.3mm or less per side, Lead 2mm: 0.25mm or less per side
Linear guide	Direct-acting infinite circulation type
Allowable static moment	Ma: 115N-m
	Mb: 115N-m
	Mc: 229N-m
Allowable dynamic moment (Note 2)	Ma: 44N-m
	Mb: 44N-m
	Mc: 89N-m
Ambient operating temp. & humidity	0 to 40°C, 85% RH or less (Non-condensing)
Degree of protection	IP20
Vibration resistance / shock resistance	4.9m/s ² 100Hz or less
Compliant international standards	CE marking, RoHS Directive
Encoder type	Battery-less Absolute Encoder
Encoder pulse count	8192 pulse/rev

(Note 2) Assumes a standard rated life of 5,000km. The running life will vary depending on operation and installation conditions. Please contact IAI for the running life.

Slider Type Moment Direction

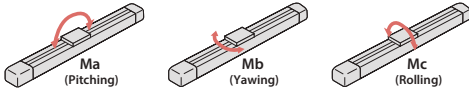

Stroke and Max Speed

Lead (mm)	Stroke	210 (mm)	260 (mm)
	8		180 <140>
2		45	

The value in angle quotes is where the operating ambient temperature is 5°C or below. (Unit: mm/s)

Gripping Force vs Electric Current Limit

The gripping (pushing) force can be adjusted freely within the range of electric current limits of 20% to 70%.

* For L1 and L2, refer to the "Gripper selection method" on P.19.

The grip force in the graph below assumes that L1 and L2 in the figure at left are zero. Grip force is the sum of both fingers.

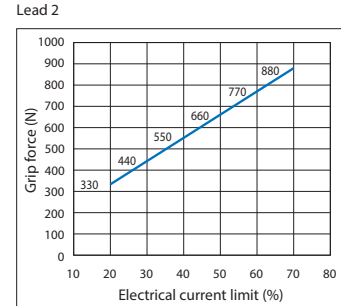
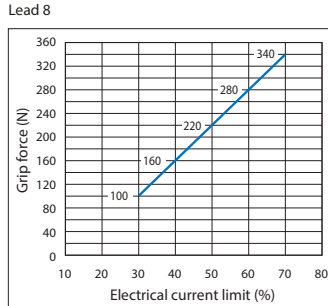
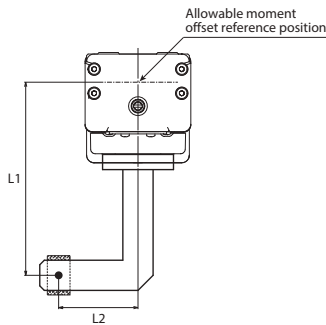

■ RCP6-GRST7C

- *1 When the sliders are returning to their home position, please be careful of interference from surrounding objects, as both the sliders will travel until they reach the M.E.
- * Both sliders simultaneously operate in opposite directions.

ST: Stroke
M.E: Mechanical end
S.E: Stroke end

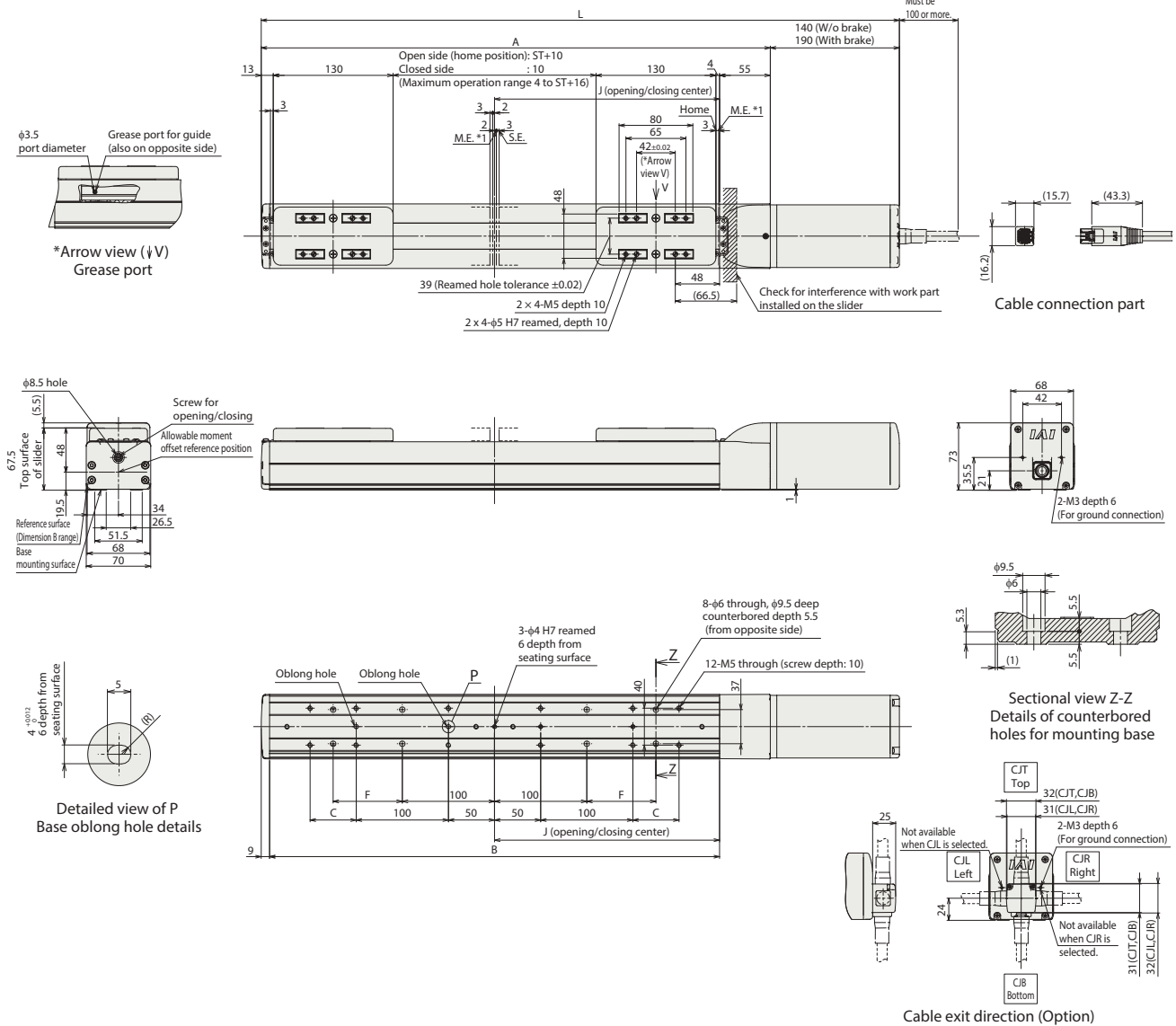

■ Dimensions by Stroke

L	Stroke	210	260
	W/o Brake	692	742
With Brake	742	792	
A	552	602	
B	488	538	
C	50	100	
F	75	100	
J	244	269	

■ Mass by Stroke

Mass (kg)	RCP6	Stroke	210	260
		W/o Brake	5.4	5.6
With Brake	5.8	6.0		

■ RCP6S-GRST7C

- *1 When the sliders are returning to their home position, please be careful of interference from surrounding objects, as both the sliders will travel until they reach the M.E.
- * Both sliders simultaneously operate in opposite directions.

ST: Stroke
M.E: Mechanical end
S.E: Stroke end

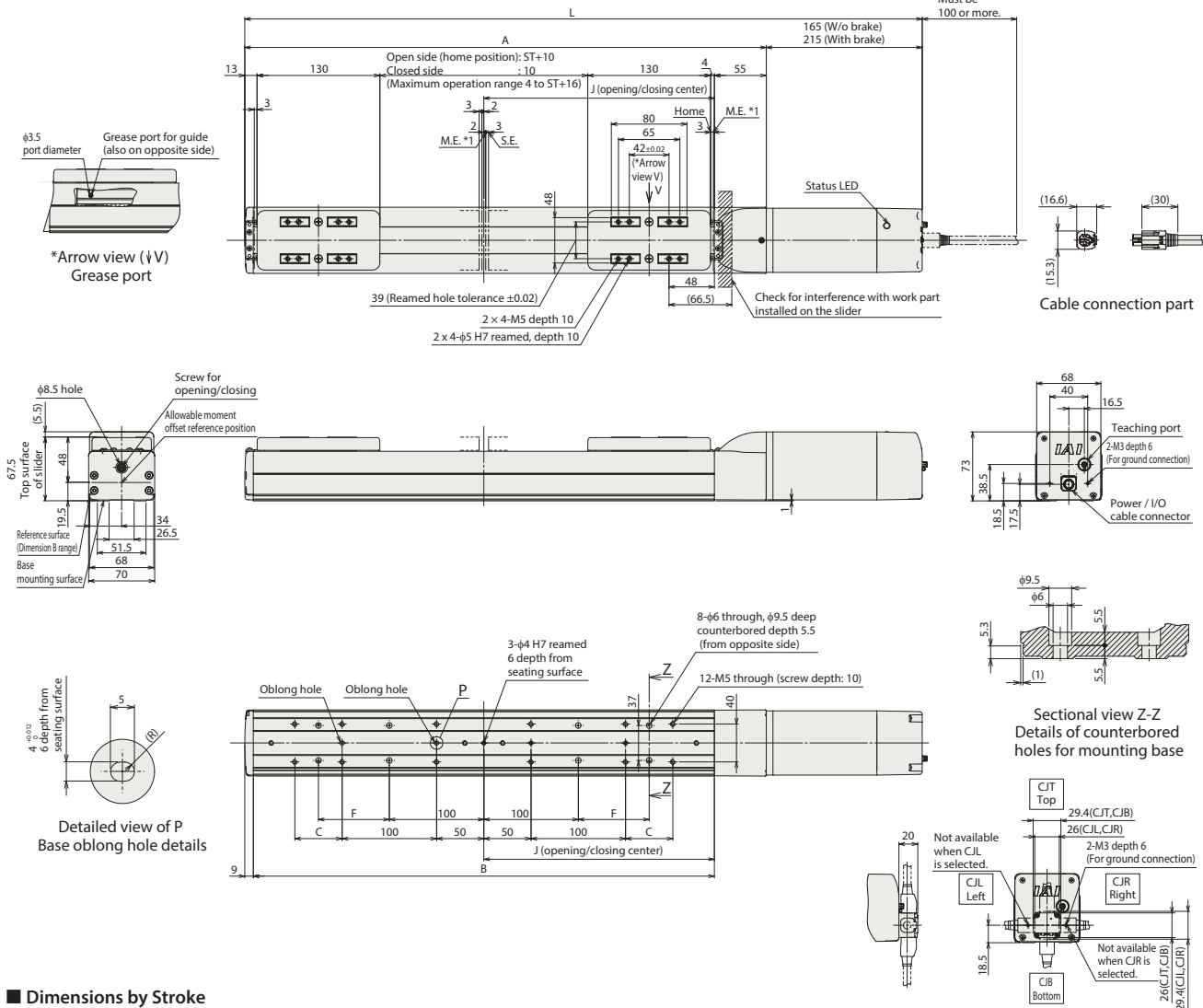

■ Dimensions by Stroke

L	Stroke		210	260
	W/o Brake	With Brake	717	767
A			552	602
B			488	538
C			50	100
F			75	100
J			244	269

■ Mass by Stroke

Mass (kg)	RCP6S	Stroke		210	260
		W/o Brake	With Brake	5.5	5.8
				6.0	6.2

Applicable Controllers

The actuators on this page can be operated by the controllers indicated below. Please select the type depending on your intended use.

Name	External view	Max. number of connectable axes	Power supply voltage	Control method			Network option *1										Maximum number of positioning points	Reference page	
				Positioner	Pulse-train	Program	DV	CC	CIE	PR	CN	ML	ML3	EC	EP	PRT			SSN
MCON-C/CG		8	24VDC	-	-	-	●	●	-	●	●	-	●	●	●	●	●	256	Please contact IAI for more information.
MCON-LC/LCG		6		-	-	●	●	●	-	●	●	-	-	●	●	-	-	256	
MSEL-PC/PG		4	Single phase 100-230VAC	-	-	●	●	●	-	-	-	-	-	●	●	-	-	30000	
PCON-CB/CGB		1	24VDC	● * Option	● * Option	-	●	●	-	●	●	●	●	●	●	-	-	512 (768 for network spec.)	
PCON-CYB/PLB/POB		1		● * Option	● * Option	-	-	-	-	-	-	-	-	-	-	-	-	64	
RCM-P6PC		1	Can be used within the RCP6S Gateway system.										768						
RCON		16	24VDC	-	-	-	●	●	●	●	-	-	-	●	●	-	-	128	RCON pamphlet

*1 For network abbreviations such as DV and CC, please contact IAI.
* For the RCP6S Series built-in controller, please contact IAI.

RCP6-GRST6R

RCP6S-GRST6R

±10μm
Simple Dustproof
Battery-less Absolute
Slide Type
2-finger
Side-mounted Motor
Body width 60*
24v Stepper Motor

Model Specification Items

Series		Type		Encoder type		Motor type		Lead		Stroke		Applicable controllers / IO type		Cable length		Options	
RCP6	Separate controller		GRST6R	WA	Battery-less Absolute	42P	Stepper motor 42□ size	8	8mm	180	180mm (90mm per side)	RCP6		N	None	Refer to Options table below.	
RCP6S	Built-in controller							2	2mm	230	230mm (115mm per side)	P3	PCON MCON MSEL	P	1m		
												P5	RCM-P6PC RCON	S	3m		
														M	5m		
														X□	Specified length		
														R□	Robot cable		
												RCP6S					
												SE	SIO type				

* Body width does not include the width of the side-mounted motor.



CE
RoHS

Horizontal
Vertical
Side
Ceiling

Stroke

Stroke (mm)	RCP6	RCP6S
180	<input type="checkbox"/>	<input type="checkbox"/>
230	<input type="checkbox"/>	<input type="checkbox"/>

Option

Name	Option code	Reference page
Brake	B	See P.21
Cable exit direction (Outside)	CJO	See P.21
Finger attachment mounting jig	MJF	See P.21
Motor side-mounted to left (Note 1)	ML	See P.22
Motor side-mounted to right (Note 1)	MR	See P.22
Non-motor end specification	NM	See P.22
Slider Roller Specification	SR	See P.22

(Note 1) Be sure to fill in one of the codes in the Model Specification Items option column.

Cable Length

Type	Cable code	RCP6-GRST6R		RCP6S-GRST6R
		P3	P5	SE
Standard type	P(1m)	<input type="checkbox"/>	<input type="checkbox"/>	<input type="checkbox"/>
	S(3m)	<input type="checkbox"/>	<input type="checkbox"/>	<input type="checkbox"/>
	M(5m)	<input type="checkbox"/>	<input type="checkbox"/>	<input type="checkbox"/>
Specified length	X06(6m) ~ X10(10m)	<input type="checkbox"/>	<input type="checkbox"/>	<input type="checkbox"/>
	X11(11m) ~ X15(15m)	<input type="checkbox"/>	<input type="checkbox"/>	<input type="checkbox"/>
	X16(16m) ~ X20(20m)	<input type="checkbox"/>	<input type="checkbox"/>	<input type="checkbox"/>
Robot cable	R01(1m) ~ R03(3m)	<input type="checkbox"/>	<input type="checkbox"/>	<input type="checkbox"/>
	R04(4m) ~ R05(5m)	<input type="checkbox"/>	<input type="checkbox"/>	<input type="checkbox"/>
	R06(6m) ~ R10(10m)	<input type="checkbox"/>	<input type="checkbox"/>	<input type="checkbox"/>
	R11(11m) ~ R15(15m)	<input type="checkbox"/>	<input type="checkbox"/>	<input type="checkbox"/>
	R16(16m) ~ R20(20m)	<input type="checkbox"/>	<input type="checkbox"/>	<input type="checkbox"/>

* Please contact IAI for more information regarding the maintenance cables.

POINT Selection Notes

- (1) The maximum opening/closing speed indicates the operating speed per side. The relative operating speed is twice this value.
- (2) The maximum grip force is the total value of both slider grip forces for the slider top surface (gripping position: 0mm, overhang amount: 0mm).
- (3) The maximum acceleration/deceleration while moving is 0.3G.
- (4) The fluctuation in grip force is ±25% (F.S.) (guideline).
- (5) The guideline for the overhang load length is 300mm or less in the Ma, Mb and Mc directions.
- (6) The self-locking function allows Lead 2 to maintain workpiece grip force even when the servo is turned off or the controller power supply is cut off. Lead 8 does not have a self-locking function.

Main Specifications

Item	Description	
Lead	Lead screw (mm)	8 2
	Max grip force (N)	110 (55 per side) 310 (155 per side)
Grip	Max speed while gripping (mm/s)	10 5
	Max speed (mm/s)	180 (per side) 45 (per side)
Speed / acceleration/ deceleration	Min speed (mm/s)	10 (per side) 5 (per side)
	Max. acceleration/deceleration (G)	0.3 0.3
Brake (option)	Brake specifications	Non-excitation actuated electromagnetic brake
	Brake retention force (kgf)	5.5 -
Opening/closing stroke	Min. stroke (mm)	180 (90 per side) 180 (90 per side)
	Max. stroke (mm)	230 (115 per side) 230 (115 per side)

Item	Description
Drive system	Left/right trapezoidal screw
Positioning repeatability	±0.01mm
Backlash	Lead 8mm: 0.3mm or less per side, Lead 2mm: 0.25mm or less per side
Lost motion	Lead 8mm: 0.3mm or less per side, Lead 2mm: 0.25mm or less per side
Linear guide	Direct-acting infinite circulation type
Allowable static moment	Ma: 48N-m
	Mb: 69N-m
	Mc: 103N-m
Allowable dynamic moment (Note 2)	Ma: 11N-m
	Mb: 16N-m
	Mc: 24N-m
Ambient operating temp. & humidity	0 to 40°C, 85% RH or less (Non-condensing)
Degree of protection	IP20
Vibration resistance / shock resistance	4.9m/s ² 100Hz or less
Compliant international standards	CE marking, RoHS Directive
Encoder type	Battery-less Absolute Encoder
Encoder pulse count	8192 pulse/rev

(Note 2) Assumes a standard rated life of 5,000km. The running life will vary depending on operation and installation conditions. Please contact IAI for the running life.

Slider Type Moment Direction

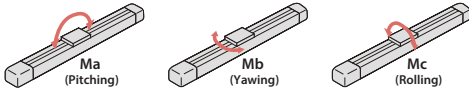

Stroke and Max Speed

Lead (mm)	Stroke	
	180 (mm)	230 (mm)
8	180	
2	45	

(Unit: mm/s)

Gripping Force vs Electric Current Limit

The gripping (pushing) force can be adjusted freely within the range of electric current limits of 30% to 70%.

* For L1 and L2, refer to the "Gripper selection method" on P.19.

The grip force in the graph below assumes that L1 and L2 in the figure at left are zero. Grip force is the sum of both fingers.

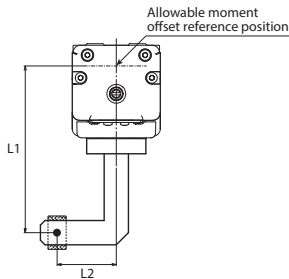

Lead 8

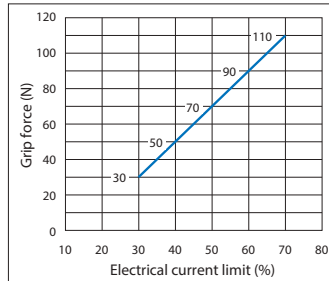

Lead 2

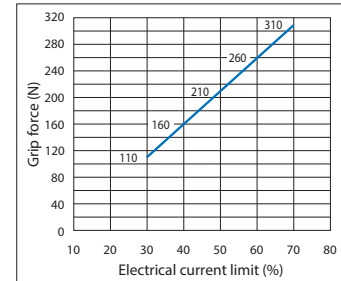

■ RCP6-GRST6R

- *1 When the sliders are returning to their home position, please be careful of interference from surrounding objects, as both the sliders will travel until they reach the M.E.
- * When fixing the actuator using counterbored holes, first remove the motor cover and then the side cover.
- * The figure below is the motor side-mounted to left (ML).
- * Both sliders simultaneously operate in opposite directions.

ST: Stroke
M.E: Mechanical end
S.E: Stroke end

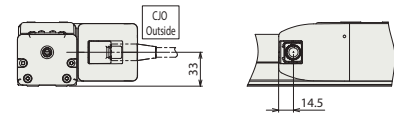
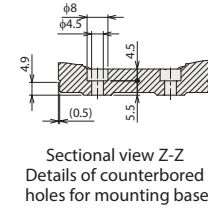
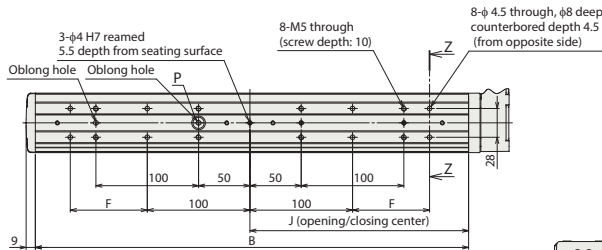
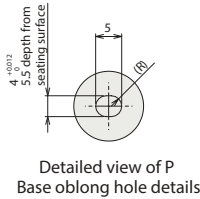
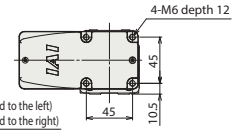
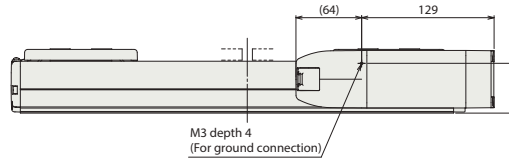
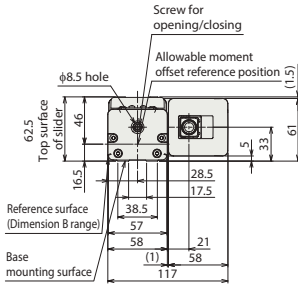
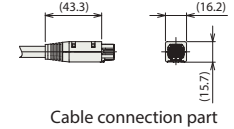
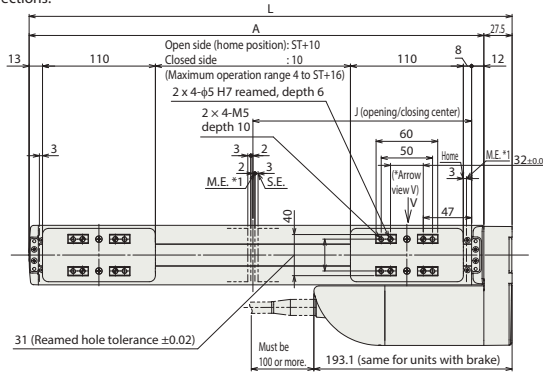
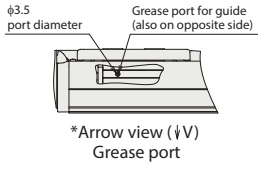

■ Dimensions by Stroke

Stroke		180	230
L	W/o Brake	470.5	520.5
	With Brake		
A		443	493
B		422	472
F		75	100
J		213	238

■ Mass by Stroke

Stroke		180	230
Mass (kg)	W/o Brake	3.5	3.6
	With Brake	3.5	3.7

■ RCP6S-GRST6R

- *1 When the sliders are returning to their home position, please be careful of interference from surrounding objects, as both the sliders will travel until they reach the M.E.
- * When fixing the actuator using counterbored holes, first remove the motor cover and then the side cover.
- * The figure below is the motor side-mounted to left (ML).
- * Both sliders simultaneously operate in opposite directions.

ST: Stroke
M.E: Mechanical end
S.E: Stroke end

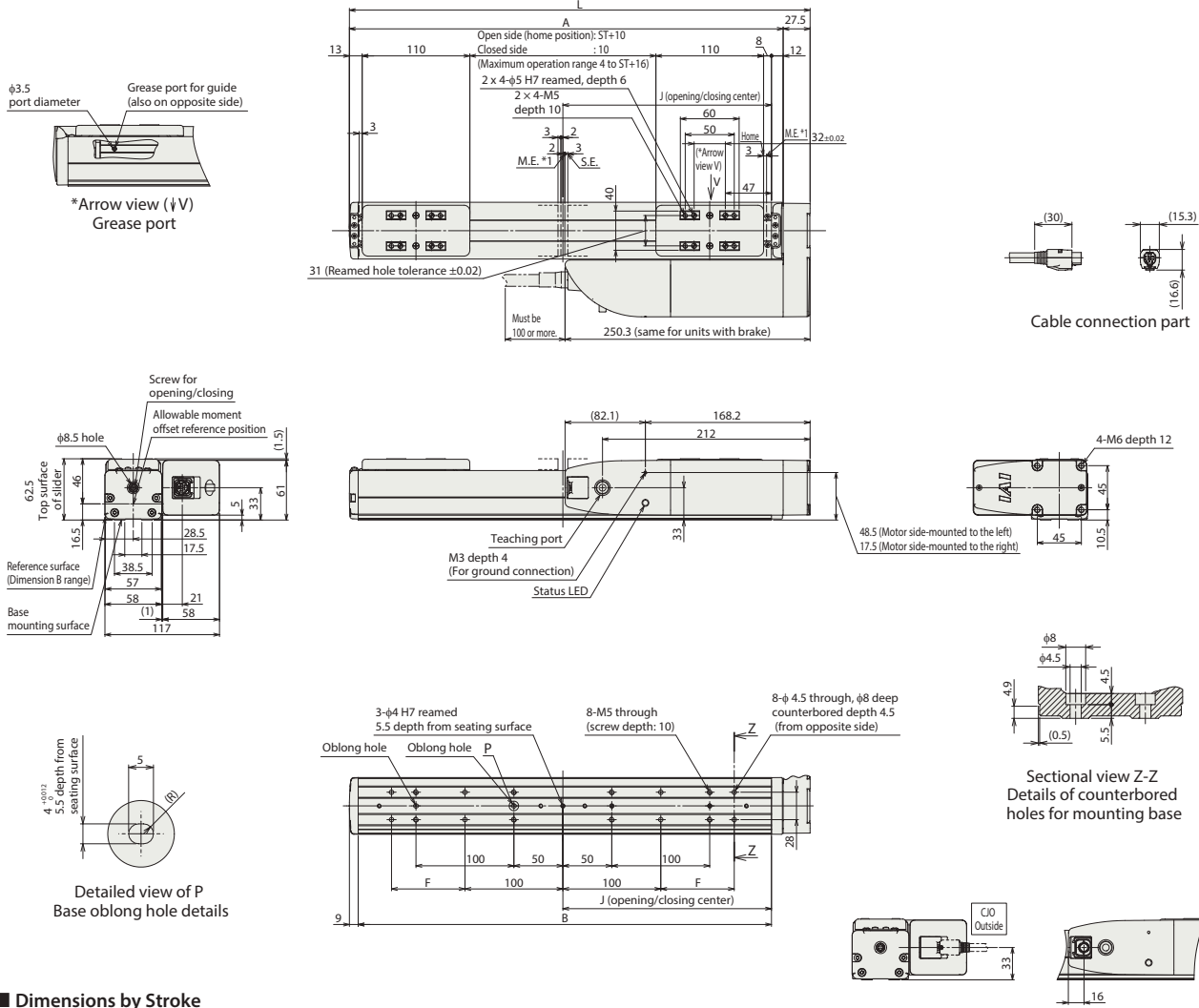

■ Dimensions by Stroke

L	Stroke		180	230
	W/o Brake	With Brake	470.5	520.5
A			443	493
B			422	472
F			75	100
J			213	238

■ Mass by Stroke

Mass (kg)	RCP6S	Stroke		180	230
		W/o Brake	With Brake	3.6	3.8
				3.7	3.8

Applicable Controllers

The actuators on this page can be operated by the controllers indicated below. Please select the type depending on your intended use.

Name	External view	Max. number of connectable axes	Power supply voltage	Control method													Maximum number of positioning points	Reference page
				Positioner	Pulse-train	Program	Network option *1											
				DV	CC	CIE	PR	CN	ML	ML3	EC	EP	PRT	SSN	ECM			
MCON-C/CG		8	24VDC	-	-	-	●	●	-	●	●	-	●	●	●	●	256	Please contact IAI for more information.
MCON-LC/LCG		6		-	-	●	●	-	●	●	-	●	●	-	-	-	256	
MSEL-PC/PG		4	Single phase 100-230VAC	-	-	●	●	-	●	-	-	●	●	-	-	30000		
PCON-CB/CGB		1	24VDC	●	●	-	●	●	●	●	●	●	●	-	-	512 (768 for network spec.)		
PCON-CYB/PLB/POB		1		* Option	* Option	-	-	-	-	-	-	-	-	-	-	-	64	
RCM-P6PC		1	Can be used within the RCP6S Gateway system.													768		
RCON		16	24VDC	-	-	-	●	●	●	●	-	-	●	●	-	128	RCON pamphlet	

*1 For network abbreviations such as DV and CC, please contact IAI.
* For the RCP6S Series built-in controller, please contact IAI.

RCP6-GRST7R

RCP6S-GRST7R



Simple Dustproof

Battery-less Absolute

Slide Type

2-finger



Body width
70 mm*

24V Stepper Motor

Model Specification Items

	GRST7R	WA	56P						
Series	Type	Encoder type	Motor type	Lead	Stroke	Applicable controllers / I/O type	Cable length	Options	
RCP6 Separate controller RCP6S Built-in controller		WA Battery-less Absolute	56P Stepper motor 56□ size	8 8mm 2 2mm	210 210mm (105mm per side) 260 260mm (130mm per side)	RCP6 P3 PCON MCON MSEL P5 RCM-P6PC RCON RCP6S SE SIO type	N None P 1m S 3m M 5m X□ Specified length R□ Robot cable	Refer to Options table below.	

* Body width does not include the width of the side-mounted motor.



Stroke

Stroke (mm)	RCP6	RCP6S
210	<input type="checkbox"/>	<input type="checkbox"/>
260	<input type="checkbox"/>	<input type="checkbox"/>

Option

Name	Option code	Reference page
Brake	B	See P.21
Cable exit direction (Outside)	CJO	See P.21
Finger attachment mounting jig	MJF	See P.21
Motor side-mounted to left (Note 1)	ML	See P.22
Motor side-mounted to right (Note 1)	MR	See P.22
Non-motor end specification	NM	See P.22
Slider roller specification	SR	See P.22
Slider spacer	SS	See P.22

(Note 1) Be sure to fill in one of the codes in the Model Specification Items option column.

Cable Length

Type	Cable code	RCP6-GRST7R		RCP6S-GRST7R
		P3	P5	SE
Standard type	P (1m)	<input type="checkbox"/>	<input type="checkbox"/>	<input type="checkbox"/>
	S (3m)	<input type="checkbox"/>	<input type="checkbox"/>	<input type="checkbox"/>
	M (5m)	<input type="checkbox"/>	<input type="checkbox"/>	<input type="checkbox"/>
Specified length	X06 (6m) ~ X10 (10m)	<input type="checkbox"/>	<input type="checkbox"/>	<input type="checkbox"/>
	X11 (11m) ~ X15 (15m)	<input type="checkbox"/>	<input type="checkbox"/>	<input type="checkbox"/>
	X16 (16m) ~ X20 (20m)	<input type="checkbox"/>	<input type="checkbox"/>	<input type="checkbox"/>
Robot cable	R01 (1m) ~ R03 (3m)	<input type="checkbox"/>	<input type="checkbox"/>	<input type="checkbox"/>
	R04 (4m) ~ R05 (5m)	<input type="checkbox"/>	<input type="checkbox"/>	<input type="checkbox"/>
	R06 (6m) ~ R10 (10m)	<input type="checkbox"/>	<input type="checkbox"/>	<input type="checkbox"/>
	R11 (11m) ~ R15 (15m)	<input type="checkbox"/>	<input type="checkbox"/>	<input type="checkbox"/>
	R16 (16m) ~ R20 (20m)	<input type="checkbox"/>	<input type="checkbox"/>	<input type="checkbox"/>

* Please contact IAI for more information regarding the maintenance cables.

POINT Selection Notes

- (1) The maximum opening/closing speed indicates the operating speed per side. The relative operating speed is twice this value.
- (2) The maximum grip force is the total value of both slider grip forces for the slider top surface (gripping position: 0mm, overhang amount: 0mm).
- (3) The maximum acceleration/deceleration while moving is 0.3G.
- (4) The fluctuation in grip force is $\pm 25\%$ (F.S.) (guideline).
- (5) The guideline for the overhang load length is 300mm or less in the Ma, Mb and Mc directions.
- (6) The self-locking function allows Lead 2 to maintain workpiece grip force even when the servo is turned off or the controller power supply is cut off. Lead 8 does not have a self-locking function.

Main Specifications

Item	Description	
Lead	Lead screw (mm)	8 2
	Max grip force (N)	340 (170 per side) 880 (440 per side)
Grip	Max speed while gripping (mm/s)	10 5
	Max. speed (mm/s) (Note 2)	180 (per side) <140 (per side)> 45 (per side)
Speed / acceleration/ deceleration	Min speed (mm/s)	10 (per side) 5 (per side)
	Max. acceleration/deceleration (G)	0.3 0.3
Brake (option)	Brake specifications	Non-excitation actuated electromagnetic brake
	Brake retention force (kgf)	17 -
Opening/closing stroke	Min. stroke (mm)	210 (105 per side) 210 (105 per side)
	Max. stroke (mm)	260 (130 per side) 260 (130 per side)

(Note 2) Value in brackets < > is where the operating ambient temperature is 5°C or below.

Item	Description
Drive system	Left/right trapezoidal screw
Positioning repeatability	±0.01mm
Backlash	Lead 8mm: 0.3mm or less per side, Lead 2mm: 0.25mm or less per side
Lost motion	Lead 8mm: 0.3mm or less per side, Lead 2mm: 0.25mm or less per side
Linear guide	Direct-acting infinite circulation type
Allowable static moment	Ma: 115N-m
	Mb: 115N-m
	Mc: 229N-m
Allowable dynamic moment (Note 3)	Ma: 44N-m
	Mb: 44N-m
	Mc: 89N-m
Ambient operating temp. & humidity	0 to 40°C, 85% RH or less (Non-condensing)
Degree of protection	IP20
Vibration resistance / shock resistance	4.9m/s ² 100Hz or less
Compliant international standards	CE marking, RoHS Directive
Encoder type	Battery-less Absolute Encoder
Encoder pulse count	8192 pulse/rev

(Note 3) Assumes a standard rated life of 5,000km. The running life will vary depending on operation and installation conditions. Please contact IAI for the running life.

Slider Type Moment Direction

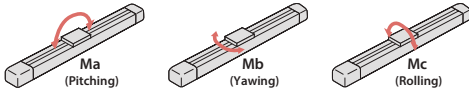

Stroke and Max Speed

Lead (mm)	Stroke	210 (mm)	260 (mm)
	8		180 <140>
2			45

The value in angle quotes is where the operating ambient temperature is 5°C or below. (Unit: mm/s)

Gripping Force vs Electric Current Limit

The gripping (pushing) force can be adjusted freely within the range of electric current limits of 20% to 70%.

* For L1 and L2, refer to the "Gripper selection method" on P.19.

The grip force in the graph below assumes that L1 and L2 in the figure at left are zero. Grip force is the sum of both fingers.

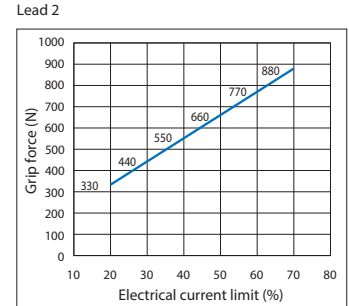
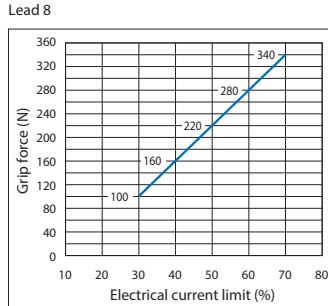
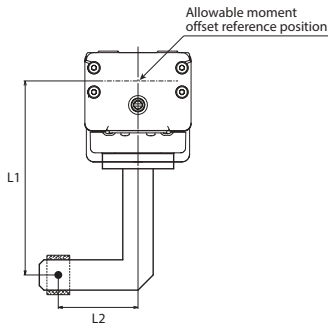

■ RCP6-GRST7R

- *1 When the sliders are returning to their home position, please be careful of interference from surrounding objects, as both the sliders will travel until they reach the M.E.
- * When fixing the actuator using counterbored holes, first remove the motor cover and then the side cover.
- * The figure below is the motor side-mounted to left (ML).
- * Both sliders simultaneously operate in opposite directions.

ST: Stroke
M.E: Mechanical end
S.E: Stroke end

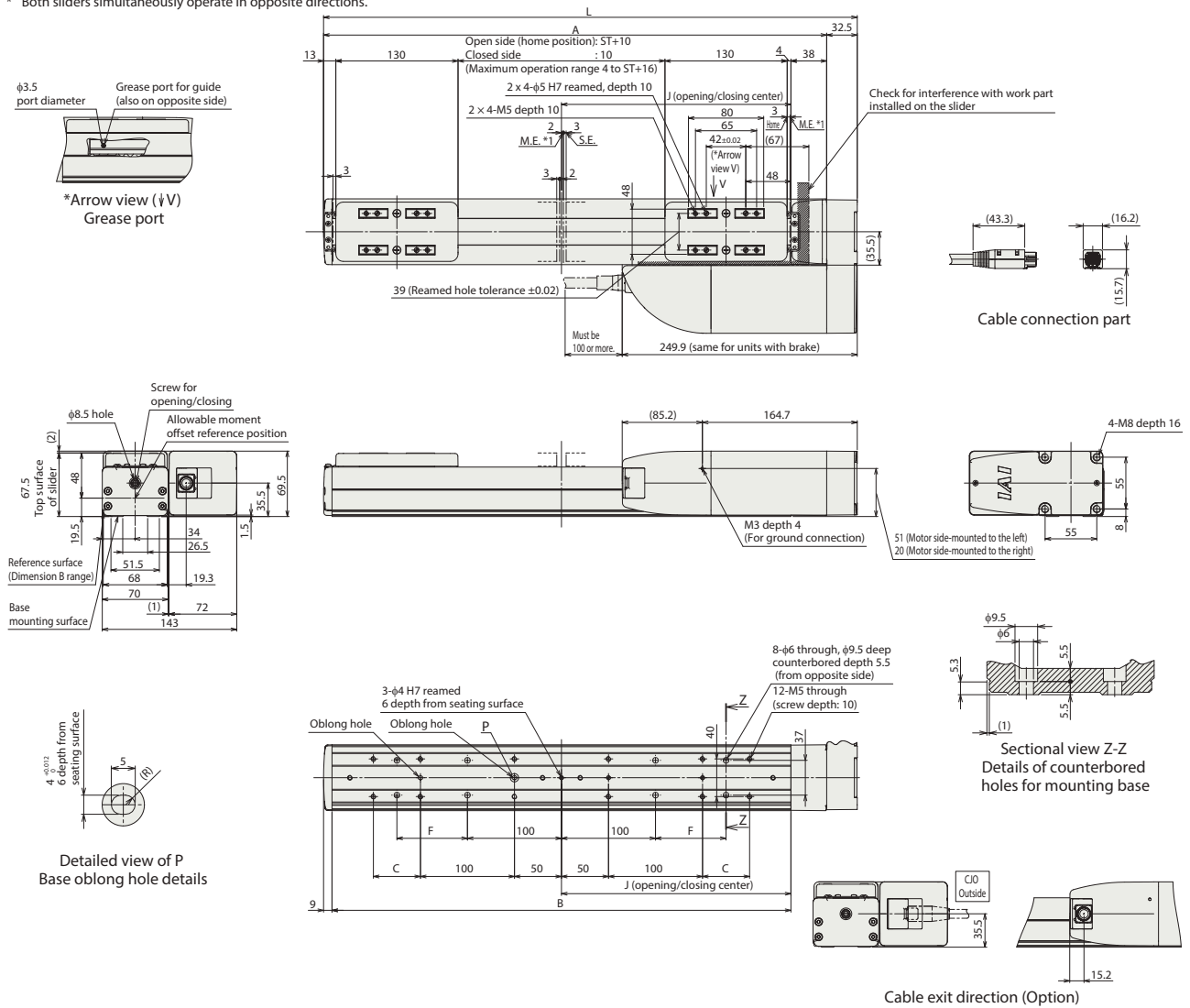

■ Dimensions by Stroke

Stroke		210	260
L	W/o Brake	567.5	617.5
	With Brake		
A		535	585
B		488	538
C		50	100
F		75	100
J		244	269

■ Mass by Stroke

Stroke		210	260
Mass (kg)	RCP6	6.0	6.2
	W/o Brake		
	With Brake	6.1	6.3

■ RCP6S-GRST7R

- *1 When the sliders are returning to their home position, please be careful of interference from surrounding objects, as both the sliders will travel until they reach the M.E.
- * When fixing the actuator using counterbored holes, first remove the motor cover and then the side cover.
- * The figure below is the motor side-mounted to left (ML).
- * Both sliders simultaneously operate in opposite directions.

ST: Stroke
M.E: Mechanical end
S.E: Stroke end

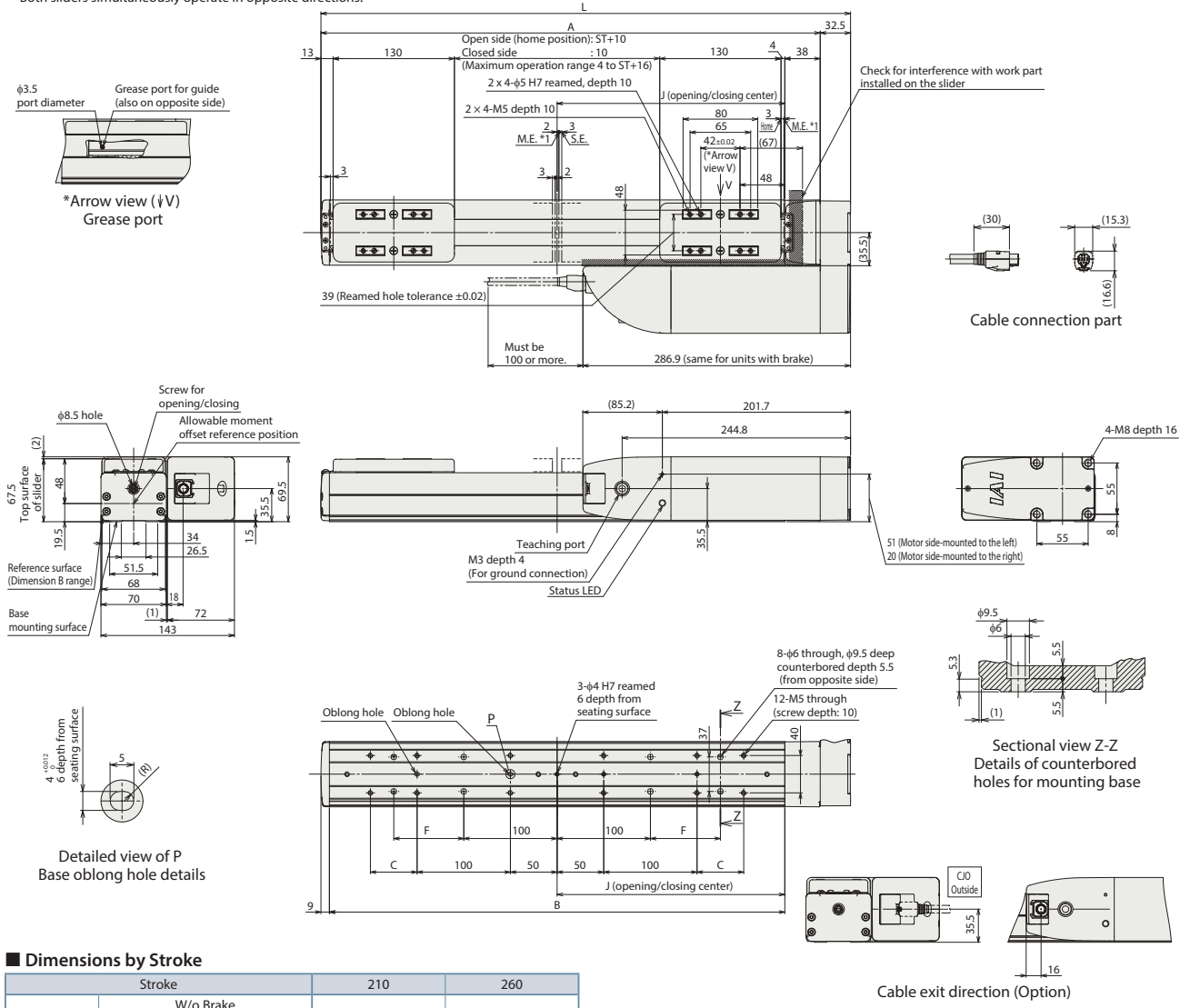

■ Dimensions by Stroke

L	Stroke		210	260
	W/o Brake	With Brake	567.5	617.5
A			535	585
B			488	538
C			50	100
F			75	100
J			244	269

■ Mass by Stroke

Mass (kg)	RCP6S	Stroke		210	260
		W/o Brake	With Brake	6.1	6.3
				6.2	6.4

■ Applicable Controllers

The actuators on this page can be operated by the controllers indicated below. Please select the type depending on your intended use.

Name	External view	Max. number of connectable axes	Power supply voltage	Control method			Network option *1										Maximum number of positioning points	Reference page	
				Positioner	Pulse-train	Program	DV	CC	CIE	PR	CN	ML	ML3	EC	EP	PRT			SSN
MCON-C/CG		8	24VDC	-	-	-	●	●	-	●	●	-	●	●	●	●	●	256	Please contact IAI for more information.
MCON-LC/LCG		6		-	-	●	●	-	●	●	-	-	●	●	-	-	-	256	
MSEL-PC/PG		4	Single phase 100~230VAC	-	-	●	●	-	●	-	-	-	●	●	-	-	-	30000	
PCON-CB/CGB		1	24VDC	* Option	* Option	-	●	●	-	●	●	-	●	●	-	-	-	512 (768 for network spec.)	
PCON-CYB/PLB/POB		1		* Option	* Option	-	-	-	-	-	-	-	-	-	-	-	-	64	
RCM-P6PC		1	Can be used within the RCP6S Gateway system.										768	RCON pamphlet					
RCON		16	24VDC	-	-	-	●	●	●	●	-	-	-		●	●	-	-	128

*1 For network abbreviations such as DV and CC, please contact IAI.
* For the RCP6S Series built-in controller, please contact IAI.

Reference Data

Gripper Selection Method

Slide type

Step 1

Check the required grip force and allowable workpiece mass



Step 2

Check the gripping point distance



Step 3

Check external force applied to fingers

Step 1 Check the required grip force and allowable workpiece mass

When gripping the workpiece with frictional grip force, calculate the required grip force as follows.

(1) For normal transfer

F: Grip force (N) ... Total sum of push forces of both fingers.
 μ : Static friction coefficient between the finger attachment and the workpiece
m: Workpiece mass (kg)
g: Gravitational acceleration ($=9.8\text{m/s}^2$)

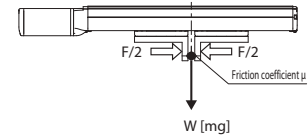

- The conditions under which the workpiece remains statically gripped without dropping are as follows:

$$F\mu > W \quad F > \frac{mg}{\mu}$$

- Assuming a recommended safety factor of 2 for normal transfer, the required gripping force is calculated as follows:

$$F > \frac{mg}{\mu} \times 2 \text{ (safety factor)}$$

- When the friction coefficient is $\mu 0.1 \sim 0.2$

$$F > \frac{mg}{0.1 \sim 0.2} \times 2 = (10 \sim 20) \times mg$$

* The greater the coefficient of static friction, the greater the maximum allowable workpiece mass. However, select a model that can generate a gripping force of at least 10 to 20 times this workpiece mass to ensure safety.

For ordinary workpiece transferring

Required grip force: ▶ **10~20 times or more the workpiece mass**

Max. allowable mass: ▶ **Not more than 1/10th to 1/20th the gripping force**

(2) When considerable acceleration, deceleration, or impact force is applied during transfer of the workpiece

In addition to gravity, a stronger inertial force is applied to the workpiece. In this case, select a model with an even higher safety factor.

When large acceleration, deceleration, or shock is applied

Required grip force: ▶ **30~50 times or more the workpiece mass**

Max. allowable mass: ▶ **Not more than 1/30th to 1/50th the gripping force**

Step 2 Check the distance to the gripping point

The distances (L, H) from the finger mounting surface to the gripping point have to fall in the ranges specified below. If the limits are exceeded, excessive moments may act upon the sliding part of the finger and internal mechanism and it could shorten the service life.

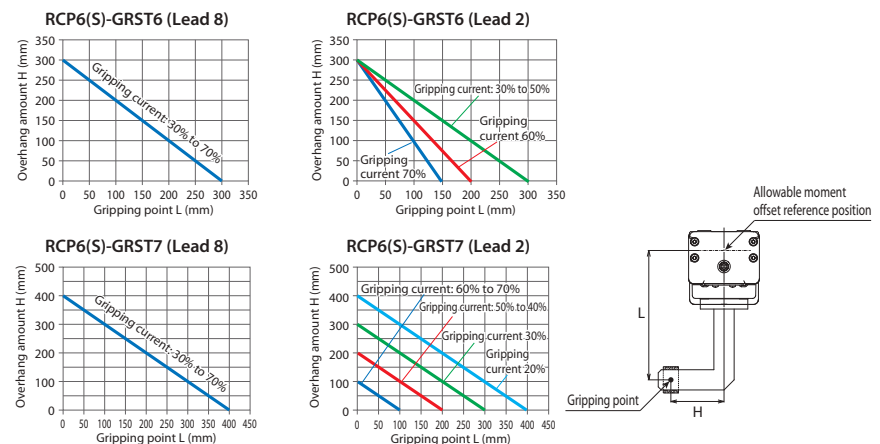

Even if the gripping point distance is within the limit range, keep it as small and lightweight as possible. If the fingers are long and large, or if the mass is large, inertial force and bending moment during opening and closing may worsen the performance and adversely affect the guide section.

Gripper Selection Method

Step 3 Check external force applied to fingers

(1) Allowable vertical load

Make sure that the vertical load applied to each finger is less than the allowable load.

(2) Allowable load moment

Calculate M_a and M_c using value of L_1 and L_2 . Make sure the moment applied to each finger is less than the maximum allowable load moment.

- The allowable external force when applying moment load to each claw is

$$\text{Allowable load } F(\text{N}) > \frac{M (\text{Maximum allowable moment (N-m)})}{L(\text{mm}) \times 10^3}$$

Calculate $F(\text{N})$ using L_1 and L_2 .

Check that the external force applied to the finger is less than the calculated allowable load $F(\text{N})$ (the smaller value of L_1 and L_2).

Model	Allowable vertical load F (N)	Maximum allowable load moment (N-m)		
		M_a	M_b	M_c
RCP6(S)-GRST6	1080	48.5	69.3	103
RCP6(S)-GRST7	1400	115	115	229

1. The allowable value above indicates a static value. 2. Indicates the allowable value per finger.

* The weight of the finger and the workpiece weight are also part of the external force. Other external forces applied to the fingers are the centrifugal force when swiveling the gripper with the workpiece gripped and the inertia force due to acceleration/deceleration during travel.

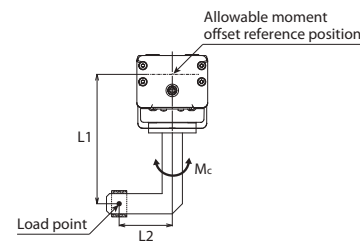
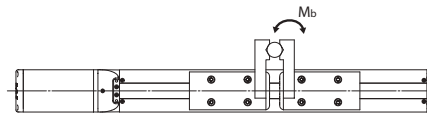
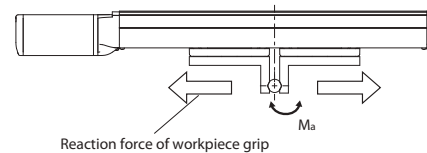

* The load point above indicates the load position on the fingers. The position varies depending on the type of load.

- Load due to grip force: Gripping point
- Load due to gravity: Center mass location
- Inertial force during travel, centrifugal force during swivel: Center mass location

The load moment is the total value calculated for each type of load.

Duty Cycle

Duty cycle is the percentage of the actuator's active operation time in each cycle. Operation is possible at 100% of the duty cycle.

[Duty Cycle]

Duty cycle is the percentage of the actuator's active operation time in each cycle.

$$D = \frac{T_M}{T_M + T_R} \times 100(\%)$$

D: Duty
 T_M : Operating time
 (including push-motion operation)
 T_R : Stopping time

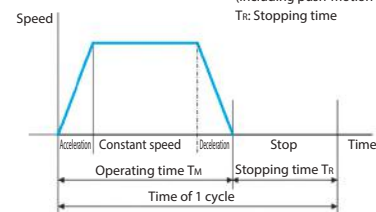

RCP6 Series Options

Brake

Model

B

Applicable models

All Models

Description

It prevents the slider from falling when the actuator is positioned vertically and the power or servo is turned off. However, it cannot maintain workpiece grip force equivalent to the self-locking function.
 * The Lead 2 self-locking function may cease to function due to vibration or impact.
 Select the brake option when using the unit in an environment where vibration or impact may be transmitted.

Cable exit direction

Model

CJT / CJR / CJL / CJB / CJO

Applicable models

All Models

Description

This option allows you to change the exit direction of the motor-encoder cable to top, bottom, left, or right.

Coupled motor type

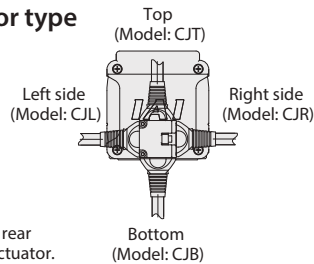

* When seen from the rear (motor side) of the actuator.

Side-mounted motor type

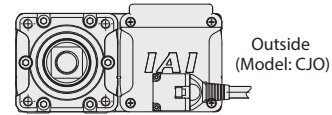

* When seen from the front of the actuator.

Finger attachment mounting jig

Model

MJF

Applicable models

All Models

Description

This is a jig for mounting the finger attachment to the slider.

RCP6(S)-GRST6C/GRST6R Model Name: RCP6-MJF-GRST6

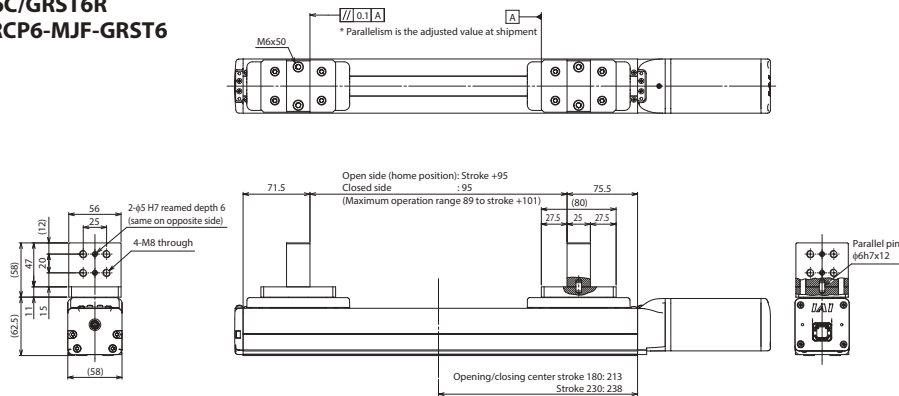

RCP6(S)-GRST7C/GRST7R Model Name: RCP6-MJF-GRST7

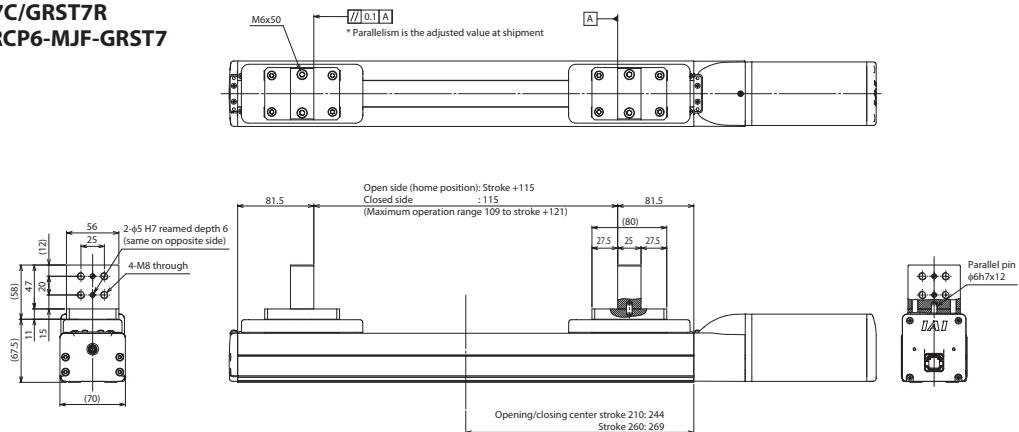

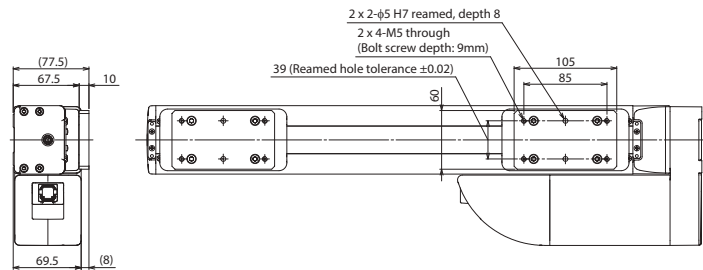
Side-mounted Motor Direction**Model** **ML / MR****Applicable models** **RCP6(S)-GRST□R****Description** This allows you to specify the direction of the side-mounted motor type.
As viewed from the motor side of the actuator, side-mounting to left is ML and right is MR.**Non-motor end specification****Model** **NM** **Applicable models** **All Models****Description** The standard home position is set to the open side, but this is the option to set the home position on the closed side in order to accommodate variations in equipment layout, etc. (Please note that changing the home position after the actuators are shipped may require the products to be sent back to IAI for re-setting.)**Slider roller specification****Model** **SR** **Applicable models** **All Models****Description** Changes the slider structure of the standard specification to the same roller structure as the cleanroom specification.**Slider spacer****Model** **SS** **Applicable models** **RCP6(S)-GRST7R****Description** This option changes the top of the slider position to be higher than the motor height.**RCP6(S)-GRST7R**
Model Name: RCP6-SS-GRST7

IAI America, Inc.

US Headquarters: 2690 W. 237th Street, Torrance, CA 90505 (800) 736-1712

Chicago Office: 110 E. State Pkwy, Schaumburg, IL 60173 (800) 944-0333

Atlanta Office: 1220 Kennestone Circle, Suite 108, Marietta, GA 30066 (888) 354-9470

www.intelligentactuator.com

The information contained in this product brochure may change without prior notice due to product improvements. Please contact IAI for latest information.

IAI Industrieroboter GmbH

Ober der Röth 4, D-65824 Schwalbach am Taunus, Germany

IAI (Shanghai) Co., Ltd.

Shanghai Jiahua Business Center A8-303, 808, Hongqiao Rd., Shanghai 200030, China

IAI Robot (Thailand) Co., Ltd.

825 Phairojkijja Tower 7th Floor, Bangna-Trad RD., Bangna, Bangna, Bangkok 10260, Thailand