

RoboCylinder Standard & Cleanroom Types
with Battery-less Absolute Encoder

RCP5/RCP5CR Series

**ROBO
CYLINDER**

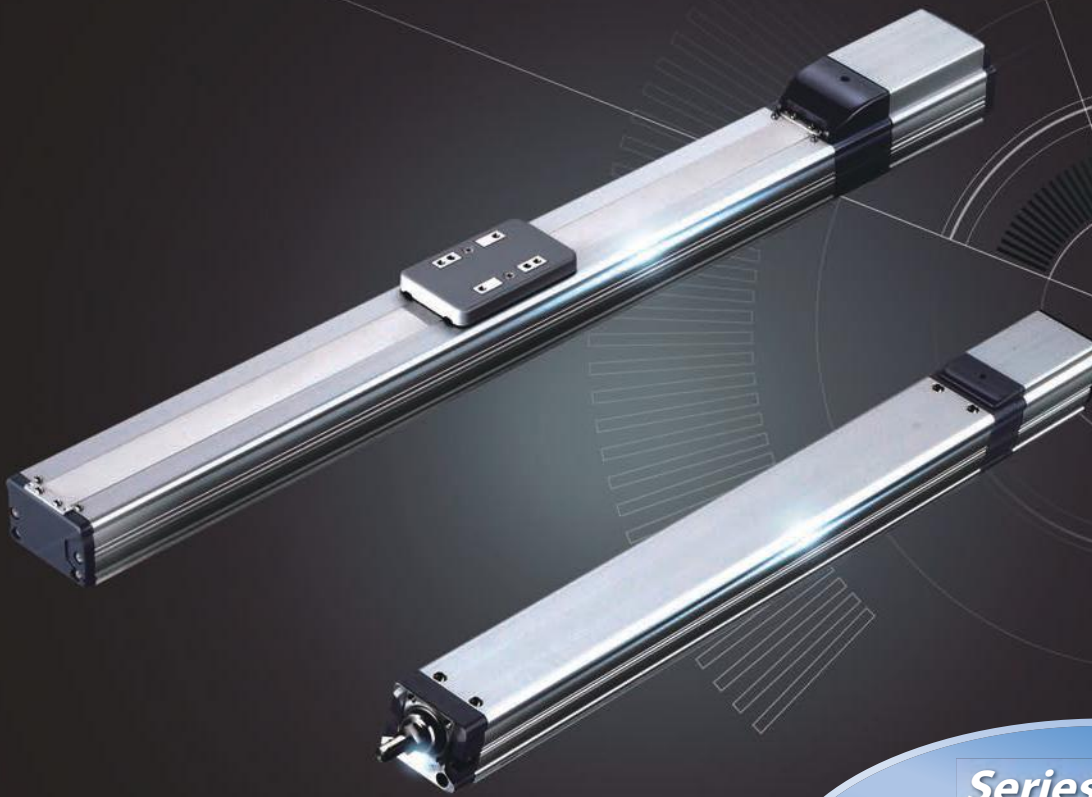

Battery-less
Absolute



Introducing the RCP5 Series, powered by a battery-less actuator, with the convenience of an absolute encoder and the cost and simplicity of an incremental encoder

The innovative battery-less absolute encoder (patent pending) operates through a combination of gears to read the rotational position data. This eliminates the need for the battery that is normally required for a conventional absolute encoder. This means there is no longer a need for battery replacement, with the associated costs and adjustments.

Slider Type



Rod Type

Radial Cylinder

Can carry radial loads.

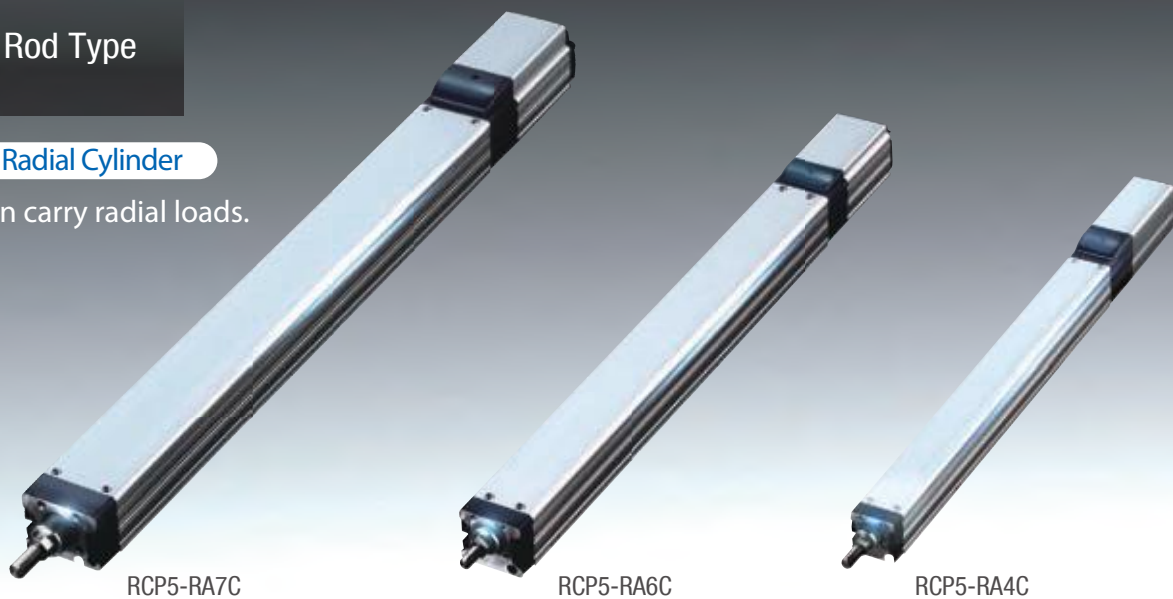

Added to the Series: Side-mounted Motor and Belt Types

Compared to the existing model (RCP2-BA), the belt type is:

- Available with a maximum stroke of 2600mm
- Equipped with a standard stainless steel dust cover
- 1.5 times greater maximum speed and maximum payload

Side-mounted
Motor Type

Belt Type

Slider Type

Rod Type (Radial Cylinder)

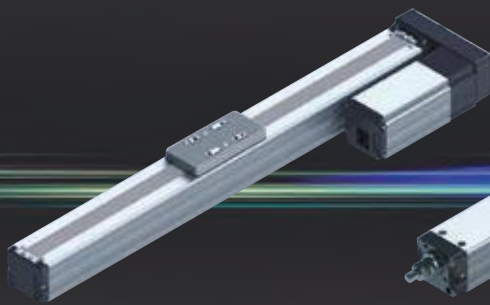

RCP5-SA4R/SA6R/SA7R

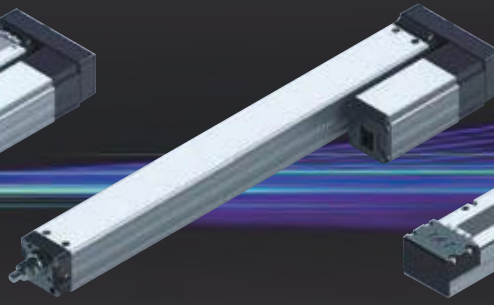

RCP5-RA4R/RA6R/RA7R

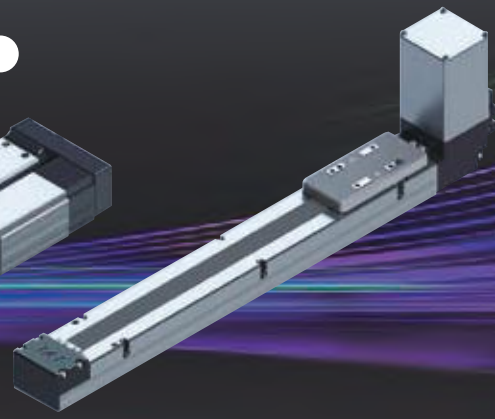

RCP5-BA4/BA6/BA7

Cleanroom
Type

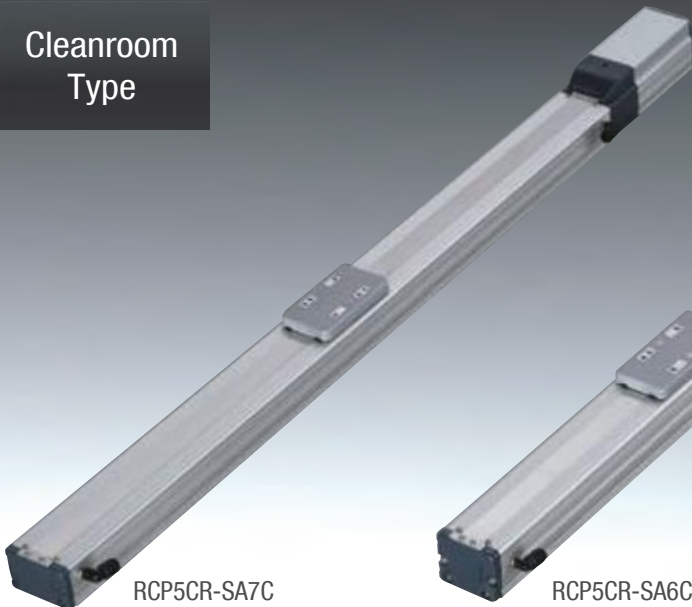

RCP5CR-SA7C



RCP5CR-SA6C



RCP5CR-SA4C

The RoboCylinder is Easy to Use!!!

Problem Solving

Manufacturing Site Problems and Solutions

Air Cylinder Problems

- 1 Reduced operation rate due to choco-tei caused by position switch failure or air pressure fluctuations
- 2 Cycle time cannot be shortened when sudden stops limit the operating speed.

Electric Actuator (Incremental Type) Problems

- 1 After an emergency stop is reset, there is a long delay before the actuator returns to its home position or for an adjustment

Electric Actuator (Absolute Type) Problems

- 1 Higher cost
- 2 Battery replacement time management is required
- 3 Battery replacement labor and cost



Electric Actuator Solutions (CT Effect)*

- 1 Choco-tei significantly reduced
- 2 Operating speeds are able to increase since there are no sudden stops

Absolute Type Solutions

- 1 Home return is not required

Battery-less Absolute Type Solutions

- 1 Battery is not required
- 2 Slider type offered at the same price as the incremental type in RCP4 Series

Problems solved with the RCP5 Series!



Battery-less
ABSOLUTE

* The "CT Effect" refers to the increase in production volume per unit of time, which enables "shorter cycle-times" and "reduced choco-tei", due to reevaluating the configuration of the automated equipment.

Feature 1

The Battery-less Absolute Encoder

What is an absolute encoder?

Incremental type

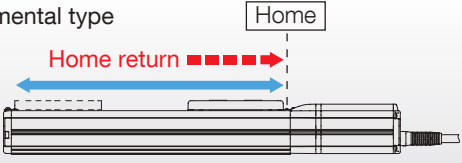

Since position data is lost when the power is shut down, this type of encoder will not operate until it has established its home position.

Absolute type

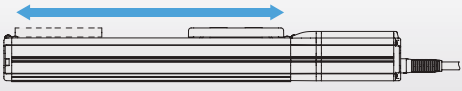

This type of encoder will maintain its position data even when the power is shut off, and will resume operating from its current position when the power is switched on.

Advantages of an absolute encoder

- Advantage 1:** Home return is not required, which means reduced amount of labor and time required for adjustment when starting up the device.
- Advantage 2:** The amount of time required for adjustment after an emergency stop until operation resumes is reduced.

What is a battery-less absolute encoder?

The battery-less absolute encoder verifies its current position based on the linked gear positions. A conventional absolute encoder uses a battery to store its current position, but since the battery-less type has no need to store this data, the battery was eliminated.



Advantages of a battery-less absolute encoder

- Advantage 1:** More economical with no cost associated with battery replacement.
- Advantage 2:** Battery replacement management is no longer required. Labor for replacement work is also no longer required.
- Advantage 3:** Battery installation space is not required.
- Advantage 4:** Even if the cable between the controller and the actuator is replaced, operation will resume with no adjustments needed, since positioning data is read each time it operates.
- Advantage 5:** No external sensor, such as a sensor to check the origin, is required since home return is not necessary.
- Advantage 6:** IAI's slider type, even with the battery-less absolute encoder, is offered for the same price as the conventional incremental type in RCP4 series.

Service life of a battery-less absolute encoder

The mechanical configuration of the battery-less absolute encoder offers a service life that is approximately four times the actuator guide's standard rating. Furthermore, it can be used with a sense of security because it will output an error when a certain amount of wear in the gear section is detected.

The RoboCylinder is Easy to Use!!!

Feature **2**

1.5 Times Higher Maximum Speed and Double the Payload When Combined with a PowerCon

Shorter cycle time significantly boosts the productivity of your system

The new controller (PowerCon) is equipped with the newly developed high-output driver (patent pending) and has achieved significantly higher speeds up to 1.5 times more than IAI's conventional models. In addition, the payload is as much as two times greater, which are astonishing improvements in specifications (*). Furthermore the maximum speed does not drop as much even when the payload increases due to increased torque with the high speed motor, meaning that the dynamic performance equivalent to that of a higher-class model can be achieved at lower cost.

(*). The specific rates of improvement vary depending on the model.

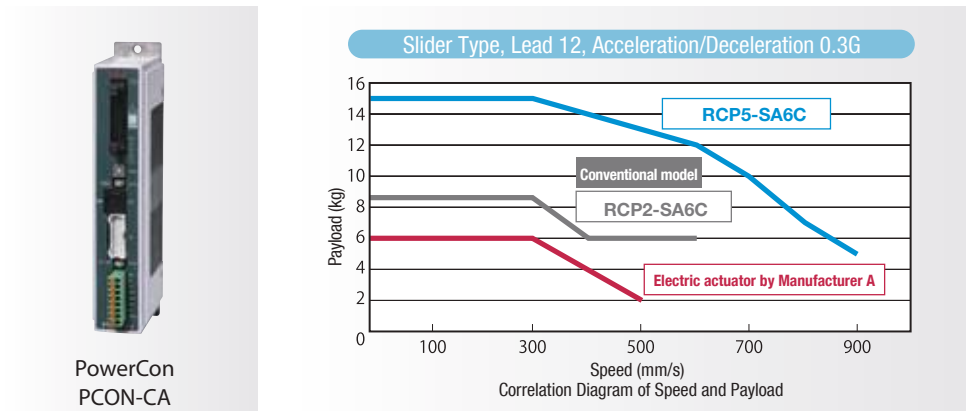

Multi-axis type is now available with a PowerCon

Since the MSEP Controller uses the PowerCon specification, it has speeds up to 1.5 times higher and a payload of up to 2 times higher compared to the existing models, and can operate a maximum of four RCP5 axes at once. Also, if high-output capability is not used, maximum of eight axes is possible. In addition, the designated target location can be changed via the field network.

A Maximum of Four RCP5 Axes Can Be Operated at Once*

Compatible Field Networks



*Up to eight axes can be operated if PowerCon is not used.



Feature **3**

The Rod Type Can Carry **Radial Loads**.

The rod type <Radial Cylinder > with a built-in guide mechanism can carry radial loads over a long stroke of up to 800mm.

The rod type (Radial Cylinder) has a built-in ball circulating type linear guide mechanism, which allows it to carry radial loads and have a long stroke of up to 800mm. In addition, the actuator can support a radial load that is offset from the center of the rod.

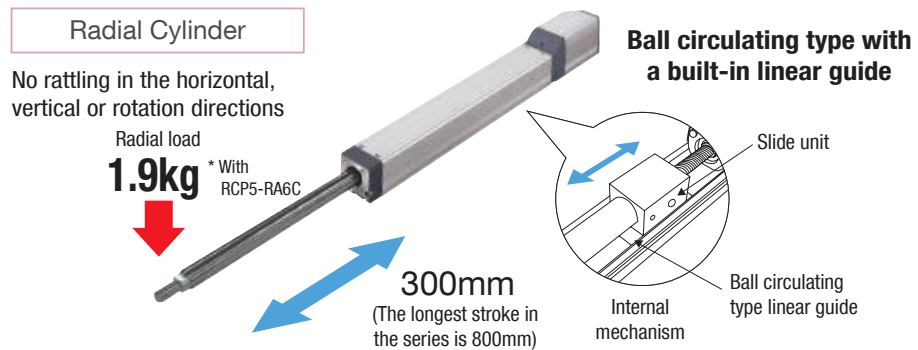

Usage example 1 When a guide mechanism is required in a tight space

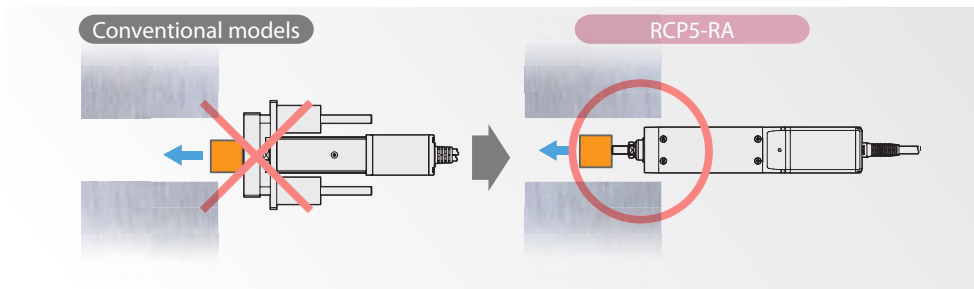

Usage example 2 When the rod needs to be straight

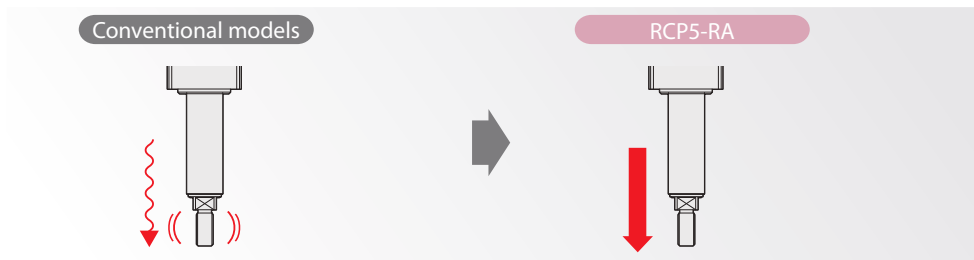

Feature **4**

Easier to Maintain

Once the frame cover is removed, both the ball screw and guide can be greased at the same time using the right and left grease nipples. (For the RCP5-RA8/RA10 models, apply grease directly to the grease nipples without removing the frame cover.)

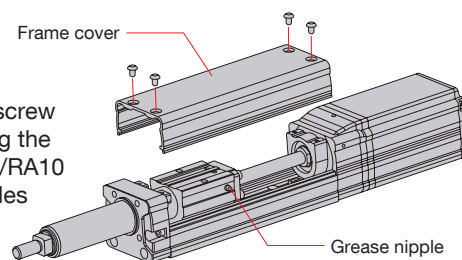













Feature **5**

Added to the Series: Side-mounted Motor and Belt Type

In addition to the cleanroom type which is applicable for ISO Cleanliness Class 4, the side-mounted motor and belt types have been added in the series.











The RoboCylinder is Easy to Use!!!

Slider Type →P. 15

Model	Type	External view	Actuator width	Stroke (mm)	Ball screw lead (mm)	Maximum speed (mm/s)	Maximum payload (kg)		Page
							Horizontal	Vertical	
Straight motor specification	SA4C			50~500	16	1260	4	1	→P. 15
					10	785	10	2.25	
					5	390	12	4.5	
					2.5	195	12	9	
	SA6C			50~800	20	1440<1280>	10	1	→P. 17
					12	900	15	2.5	
					6	450	25	6	
	SA7C			50~800	24	1200	20	3	→P. 19
					16	980<840>	40	8	
8					490	45	16		
Side-mounted motor specification	SA4R			50~500	16	1260	4	1	→P. 21
					10	785	10	2.25	
					5	390	12	4.5	
					2.5	195	12	9	
	SA6R			50~800	20	1280	10	1	→P. 23
					12	900<800>	15	2.5	
					6	450	25	6	
	SA7R			50~800	24	1000	20	3	→P. 25
					16	840<700>	40	8	
					8	490	45	16	
					4	210	45	25	
					4	210	45	25	

Values in brackets < > are for vertical use.











Rod Type →P. 27

Model	Type	External view	Actuator width	Stroke (mm)	Ball screw lead (mm)	Maximum speed (mm/s)	Maximum payload (kg)		Page
							Horizontal	Vertical	
Straight motor specification	RA4C			60~410	16	1120<840>	6	1.5	→P. 27
					10	700	15	2.5	
					5	350	28	5	
					2.5	175	40	10	
	RA6C			65~415	20	800	6	1.5	→P. 29
					12	700	25	4	
					6	450	40	10	
	RA7C			70~520	24	800<600>	20	3	→P. 31
					16	700<560>	50	8	
					8	420	60	18	
					4	210	80	28	
	RA8C			50~700	20	600<450>	30	5	→P. 33
					10	300<250>	60	40	
	RA10C			50~800	5	125	150	100	→P. 35
					10	250<167>	80	80	
					2.5	63	300	150	

Values in brackets < > are for vertical use.

Rod Type







→P. 37

Model	Type	External view	Actuator width	Stroke (mm)	Ball screw lead (mm)	Maximum speed (mm/s)	Maximum payload (kg)		Page	
							Horizontal	Vertical		
Side-mounted motor specification	RA4R			60~410	40 mm	16	840	5	1	→P. 37
						10	610	12	2.5	
						5	350	25	5	
						2.5	175	40	10	
	RA6R			65~415	58 mm	20	800	6	1.5	→P. 39
						12	700	25	4	
						6	450	40	10	
	RA7R			70~520	73 mm	24	800<600>	20	3	→P. 41
						16	560	50	8	
						8	420<350>	60	18	
	RA8R			50~700	88 mm	20	400	30	5	→P. 43
						10	200	60	40	
						5	100	100	70	
	RA10R			50~800	108 mm	10	200<140>	80	80	→P. 45
						5	100	150	100	
2.5						50	300	150		

Values in brackets <> are for vertical use.

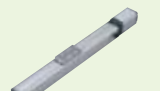
Cleanroom Type







→P. 47

Type	External view	Actuator width	Stroke (mm)	Ball screw lead (mm)	Maximum speed (mm/s)	Maximum payload (kg)		Page	
						Horizontal	Vertical		
SA4C			50~500	40 mm	16	1260	4	1	→P. 47
					10	785	10	2.25	
					5	390	12	4.5	
					2.5	195	12	9	
SA6C			50~800	58 mm	20	1440<1280>	10	1	→P. 49
					12	900	15	2.5	
					6	450	25	6	
					3	225	25	16	
SA7C			50~800	73 mm	24	1200	20	3	→P. 51
					16	980<840>	40	8	
					8	490	45	16	
					4	245<210>	45	25	

Values in brackets <> are for vertical use.

Belt Type

→P. 53

Type	External view	Actuator width	Stroke (mm)	Ball screw lead (mm)	Maximum speed (mm/s)	Maximum payload (kg)	Page
						Horizontal	
BA4/BA4U			300~1200	Equivalent to 48	1200	1.5	→P. 53
BA6/BA6U			300~2200	Equivalent to 48	1500	6	→P. 55
BA7/BA7U			300~2600	Equivalent to 48	1600	16	→P. 57

Model Specification Items

Model Specification Items

<Slider type>

RCP5 — [] — **WA** — [] — [] — [] — **P3** — [] — []

Series Type Encoder type Motor type Ball screw lead Stroke Applicable controllers Cable length Options

SA4C	Actuator width: 40mm Coupling type	WA Battery-less absolute	35P	35□ pulse motor	2.5	2.5mm	P3	PCON-CA MSEP MSEL	B Brake
SA6C	Actuator width: 58mm Coupling type		42P	42□ pulse motor	3	3mm			
SA7C	Actuator width: 73mm Coupling type	56P	56□ pulse motor	4	4mm	N No cable P 1m S 3m M 5m X□□ Specified length R□□ Robot cable	ML Motor side-mounted to the left (standard) MR Motor side-mounted to the right NM Non-motor end specification SR Slider roller specification SS Slider spacer		
SA4R	Actuator width: 40mm Side-mounted motor type			5	5mm				
SA6R	Actuator width: 58mm Side-mounted motor type			6	6mm				
SA7R	Actuator width: 73mm Side-mounted motor type			8	8mm				
				10	10mm				
				12	12mm				
				16	16mm				
				20	20mm				
				24	24mm				

* The available selections for encoder type, motor type, ball screw lead and stroke vary depending on the actuator type. For details, please refer to the page featuring each actuator type.

<Rod type: Straight motor specification>

RCP5 — [] — **WA** — [] — [] — [] — [] — [] — []

Series Type Encoder type Motor type Ball screw lead Stroke Applicable controllers Cable length Options

RA4C	Actuator width: 40mm Coupling type	WA Battery-less absolute	35P	35□ pulse motor	2.5	2.5mm	P3	PCON-CA MSEP MSEL	B Brake
RA6C	Actuator width: 58mm Coupling type		42P	42□ pulse motor	3	3mm			
RA7C	Actuator width: 73mm Coupling type	56P	56□ pulse motor	4	4mm	N No cable P 1m S 3m M 5m X□□ Specified length R□□ Robot cable	FL Flange FFA Tip adapter (flange) NFA Tip adapter (internal thread) KFA Tip adapter (keyway) NM Non-motor end specification		
RA8C	Actuator width: 88mm Coupling type	60P	60□ pulse motor	5	5mm				
RA10C	Actuator width: 108mm Coupling type	86P	86□ pulse motor	6	6mm				
				8	8mm				
				10	10mm				
				12	12mm				
				16	16mm				
				20	20mm				
				24	24mm				

* The available selections for encoder type, motor type, ball screw lead and stroke vary depending on the actuator type. For details, please refer to the page featuring each actuator type.

<Rod type: Side-mounted motor specification>

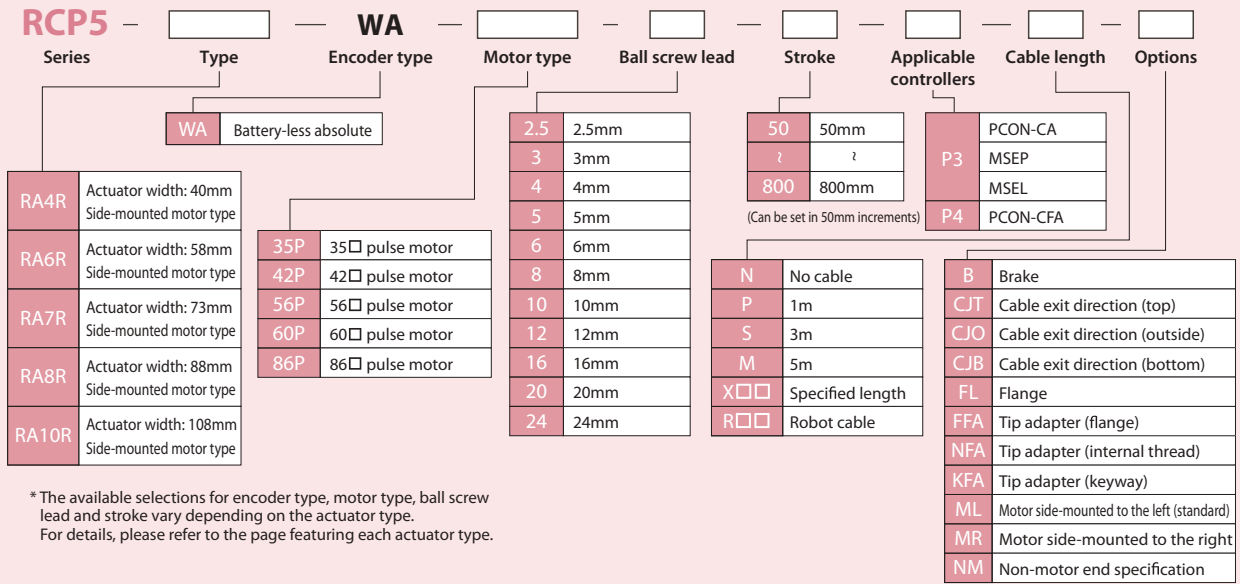

<Cleanroom type>

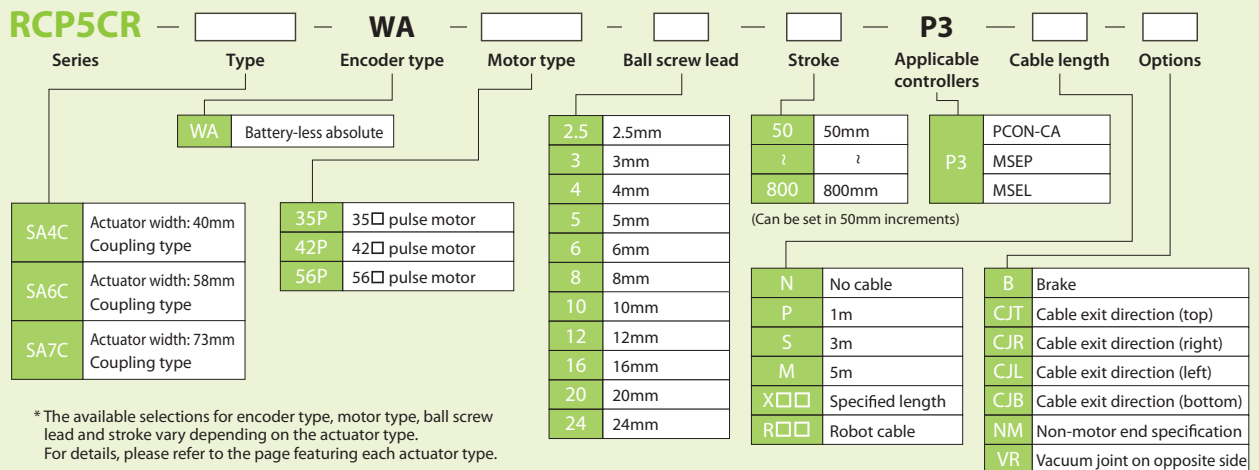

<Belt type>

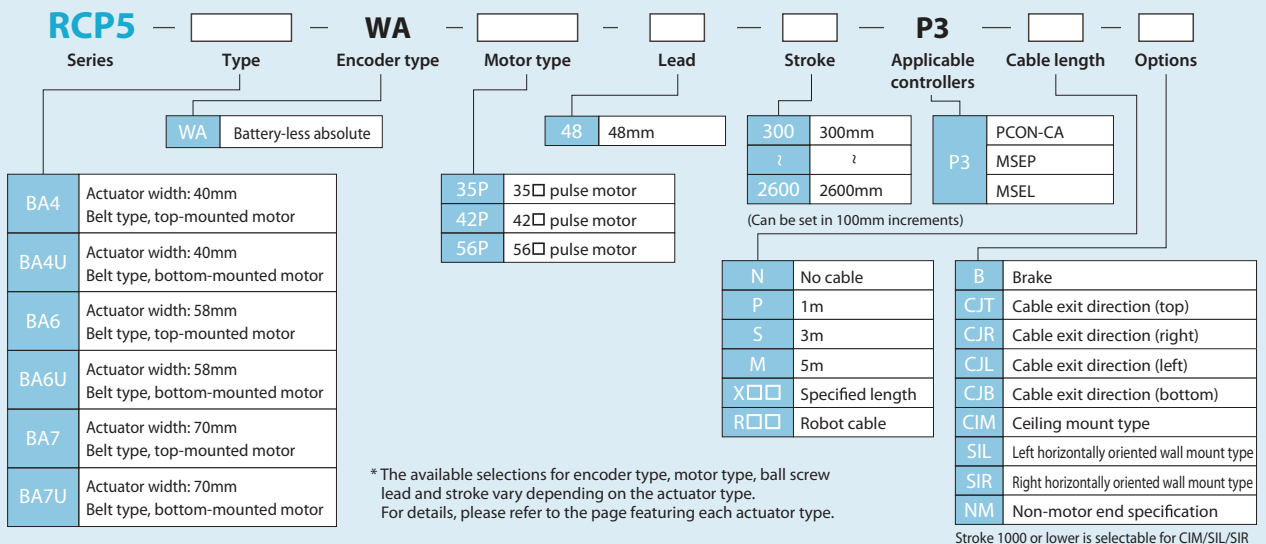

Options

Actuator Options

<p>■ Brake Option code: B</p>	<p>Applicable models All models</p> <p>Description This is a holding mechanism that prevents the slider from falling and damaging any attached fittings when the power or servo is turned off.</p>
<p>■ Optional cable exit direction Option code: CJT CJR CJL CJB CJO</p>	<p>Applicable models All models</p> <p>Description This option allows you to change the exit direction of the motor-encoder cable to up, down, left or right.</p> <div style="display: flex; justify-content: space-around;"> <div data-bbox="472 734 906 976"> <p>Motor coupled type</p> <p>* View from the rear of the actuator (motor side)</p> </div> <div data-bbox="948 734 1382 976"> <p>Side-mounted motor type</p> <p>* View from the front of the actuator</p> </div> </div>
<p>■ Side-mounted motor direction Option code: ML/MR</p> <p><small>* Please make sure to specify either "ML" or "MR" when ordering the side-mounted motor type.</small></p>	<p>Applicable models RCP5-SA□R/RA□R</p> <p>Description This allows you to specify the direction of the side-mounted motor. As viewed from the motor side of the actuator, ML represents left and MR represents right.</p> <div style="display: flex; justify-content: space-around;"> <div data-bbox="472 1133 906 1319"> <p>The motor is side-mounted to the left (standard) Option code: ML</p> </div> <div data-bbox="948 1133 1382 1319"> <p>The motor is side-mounted to the right Option code: MR</p> </div> </div>
<p>■ Non-motor end specification Option code: NM</p>	<p>Applicable models All models</p> <p>Description This option changes the home position of the actuator's slider or rod from the normal position (motor-side), to the opposite side.</p>
<p>■ Slider spacer Option code: SS</p>	<p>Applicable models RCP5-SA7R</p> <p>Description This option changes the top of the slider position to be higher than the motor height.</p>
<p>■ Slider roller specification Option code: SR</p>	<p>Applicable models RCP5-SA4□/SA6□/SA7□</p> <p>Description The slider of the standard slider type specification is changed to the same roller structure of the cleanroom type. When using the slider roller specification, the appearance and dimensions of the slider cover will be the same as the cleanroom type.</p>
<p>■ Vacuum joint on opposite side Option code: VR</p>	<p>Applicable models RCP5CR-SA4C/SA6C/SA7C</p> <p>Description The vacuum joint in the standard models are installed on the left side of the actuator as viewed from the motor side. This option changes the position to the right (opposite) side.</p>

Rod Attachment Options

Front flange

Option code: **FL**

Applicable models RCP5-RA4□/RA6□/RA7□/RA8□/RA10□

Flange

Option code :
FL

Description | A bracket that attaches to the actuator body with bolts.



RCP5-RA4□

Model number of flange
RCP5-FL-RA4

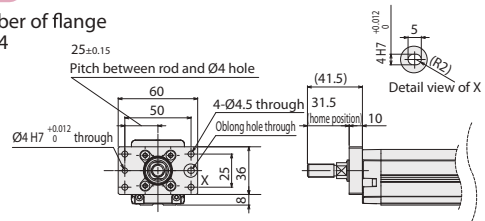

RCP5-RA6□

Model number of flange
RCP5-FL-RA6

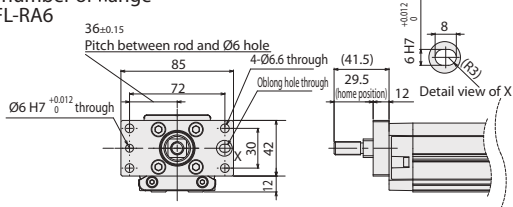

RCP5-RA7□

Model number of flange
RCP5-FL-RA7

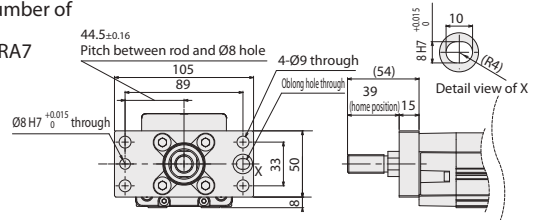

RCP5-RA8□

Model number of flange
RCP5-FL-RA8

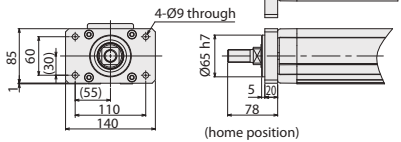

RCP5-RA10□

Model number of flange
RCP5-FL-RA10

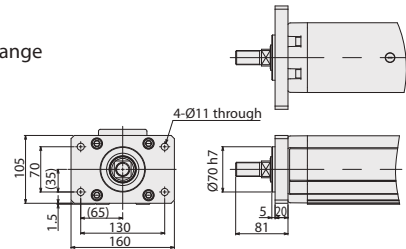

Tip Adapter (Flange)

Option code: **FFA**

Applicable models RCP5-RA4□/RA6□/RA7□

Tip Adapter (Flange)

Option code :
FFA

Description | A rod-end tooling adapter with 4 threaded holes.



RCP5-RA4□

Model number of tip adapter (flange)
RCP5-FFA-RA4

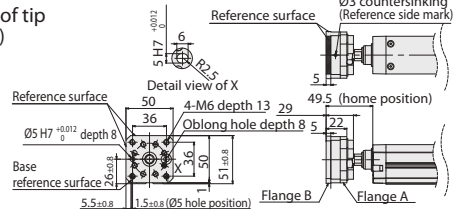

RCP5-RA6□

Model number of tip adapter (flange)
RCP5-FFA-RA6

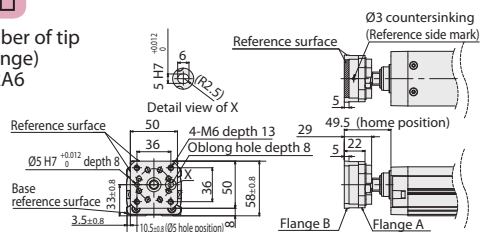

RCP5-RA7□

Model number of tip adapter (flange)
RCP5-FFA-RA7

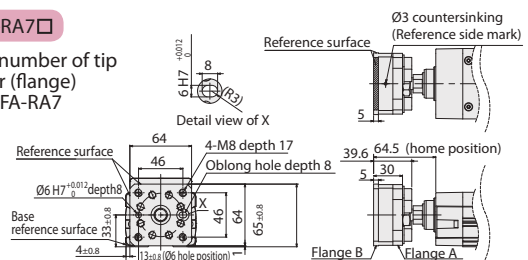

Rod Attachment Options

Tip Adapter (Internal Thread)

Option code: **NFA**

Applicable models RCP5-RA4□/RA6□/RA7□

Tip Adapter (Internal Thread):

Option code: **NFA**

Description | A threaded female tip adapter.



RCP5-RA4□

Model number of tip adapter (internal thread)
RCP5-NFA-RA4

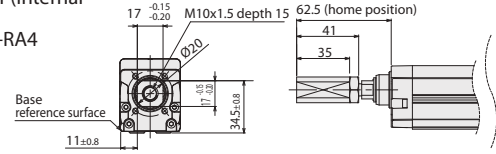

RCP5-RA6□

Model number of tip adapter (internal thread)
RCP5-NFA-RA6

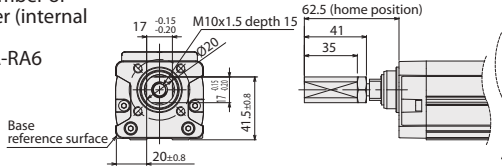

RCP5-RA7□

Model number of tip adapter (internal thread)
RCP5-NFA-RA7

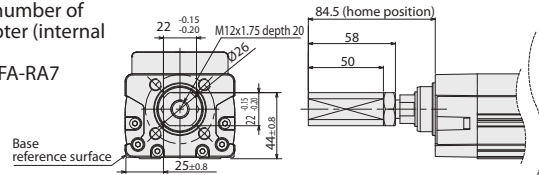

Tip Adapter (Keyway)

Option code: **KFA**

Applicable models RCP5-RA4□/RA6□/RA7□

Tip Adapter (Keyway)

Option code: **KFA**

Description | A female threaded tip adapter with a parallel keyway.



RCP5-RA4□

Model number of tip adapter (keyway)
RCP5-KFA-RA4

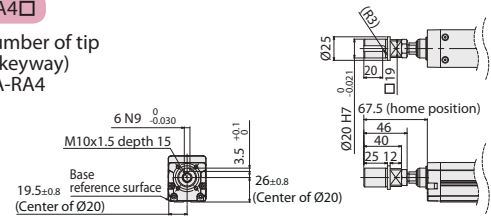

RCP5-RA6□

Model number of tip adapter (keyway)
RCP5-KFA-RA6

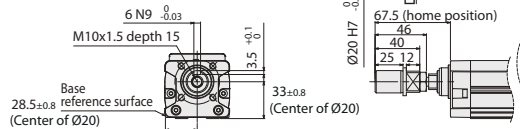

RCP5-RA7□

Model number of tip adapter (keyway)
RCP5-KFA-RA7

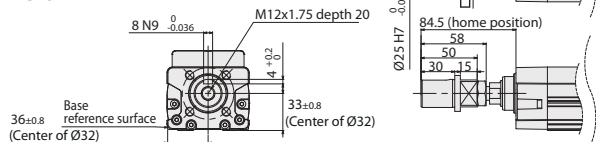

Warnings when Selecting the Rod Attachment Option

When Selecting the Front Flange (FL)

- The front flange (FL) rod attachment option cannot be selected when the following strokes are selected for RCP5-RA4R/RA6R/RA7R;

- (1) RA4R: 60mm (standard) and 60~110mm (with brake)
- (2) RA6R: 65mm (with brake)
- (3) RA7R: 70mm (standard) and 70~120mm (with brake)

- Please be careful of nearby objects when selecting the front flange (FL) option for the RCP5-RA4R/RA6R/RA7R models, as selecting a short stroke may cause some interference between the cable and installation surface for certain strokes.

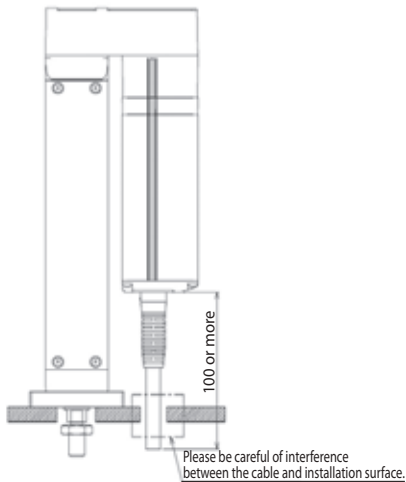

When Selecting the Tip Adapter Option (FFA, NFA, KFA)

- Please be careful of nearby objects when selecting the tip adapter option (FFA, NFA, KFA) for the RCP5-RA4R/RA6R/RA7R models, as selecting a short stroke may cause some interference between the cable and work piece for certain strokes.

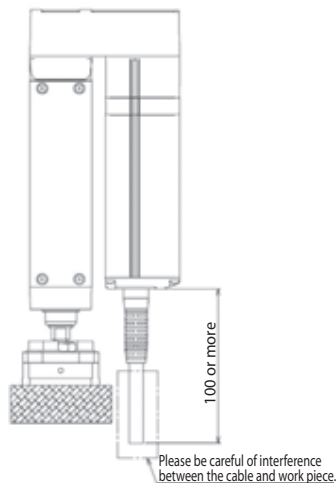
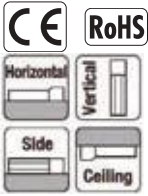

Figure above shows the case of tip adapter (Flange=FFA).

RCP5-SA4C

RoboCylinder, Slider Type, Motor Unit Coupled, Actuator Width 40mm, 24V Pulse Motor

Model	RCP5	SA4C	WA	35P				P3		
Specification	Series	Type	Encoder type	Motor type	Lead	Stroke	Applicable controllers	Cable length	Options	
Items			WA: Battery-less absolute specification	35P: Pulse motor, size 35□	16: 16mm 10: 10mm 5: 5mm 2.5: 2.5mm	50: 50mm 500: 500mm (Every 50mm)	P3: PCON-CA MSEP MSEL	N: No cable P: 1m S: 3m M: 5m X□: Specified length R□: Robot cable	Please refer to the options table below.	



* Depending on the model, there may be some limitations to using the vertical, side, and ceiling mount positions. Please refer to P.59 for details.



Correlation Diagrams of Speed and Payload

(1) High-output **enabled** with PCON-CA, MSEP, MSEL connected

RCP5-SA4C, Horizontal mount

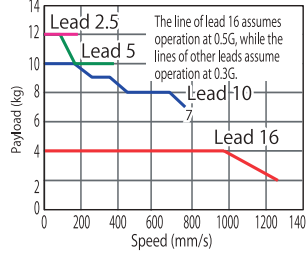

RCP5-SA4C, Vertical mount

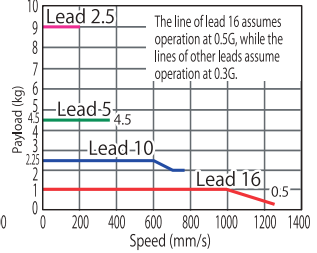

(2) High-output **disabled** with PCON-CA, MSEP connected

RCP5-SA4C, Horizontal mount

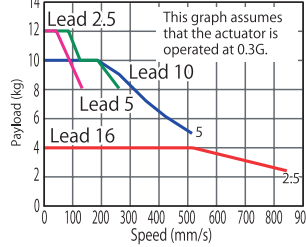

RCP5-SA4C, Vertical mount

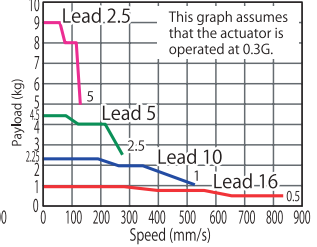

- The actuator specification displays the payload's maximum value, but it will vary depending on the acceleration. Please refer to the "Selection Guidelines" (RCP5 Payload by Speed/Acceleration Table) on P. 61.
- Please refer to P. 59 for push-motion operation.

Actuator Specifications

Lead and Payload

Model number	Lead (mm)	Connected controller	Maximum payload		Stroke (mm)
			Horizontal (kg)	Vertical (kg)	
RCP5-SA4C-WA-35P-16-①-P3-②-③	16	High-output enabled High-output disabled	4 1	1	50~500 (Every 50mm)
RCP5-SA4C-WA-35P-10-①-P3-②-③	10	High-output enabled High-output disabled	10 2.25	2.25	
RCP5-SA4C-WA-35P-5-①-P3-②-③	5	High-output enabled High-output disabled	12 4.5	4.5	
RCP5-SA4C-WA-35P-2.5-①-P3-②-③	2.5	High-output enabled High-output disabled	12 9	9	

Legend: ① Stroke ② Cable length ③ Options

Stroke and Maximum Speed

(Unit: mm/s)

Lead (mm)	Connected controller	50~400 (Every 50mm)	450 (mm)	500 (mm)
16	High-output enabled	1260	1060	875
	High-output disabled	840		
10	High-output enabled	785	675	555
	High-output disabled	525		
5	High-output enabled	390	330	275
	High-output disabled	260		
2.5	High-output enabled	195	165	135
	High-output disabled	130		

Cable Length

Type	Cable code
Standard type	P (1m)
	S (3m)
	M (5m)
Special length	X06 (6m) ~X10 (10m)
	X11 (11m) ~X15 (15m)
	X16 (16m) ~X20 (20m)
Robot cable	R01 (1m) ~R03 (3m)
	R04 (4m) ~R05 (5m)
	R06 (6m) ~R10 (10m)
	R11 (11m) ~R15 (15m)
	R16 (16m) ~R20 (20m)

Options

Name	Option code	Reference page
Brake	B	→P. 11
Cable exit direction (Top)	CJT	→P. 11
Cable exit direction (Right)	CJR	→P. 11
Cable exit direction (Left)	CJL	→P. 11
Cable exit direction (Bottom)	CJB	→P. 11
Slider roller specification	SR	→P. 11
Non-motor end specification	NM	→P. 11

Actuator Specifications

Item	Description
Drive system	Ball screw Ø8mm, rolled C10
Positioning repeatability	±0.02mm
Lost motion	0.1mm or less
Base	Material: Aluminum with white alumite treatment
Dynamic allowable moment (*1)	Ma: 4.98N·m, Mb: 7.11N·m, Mc: 9.68N·m
Static allowable moment	Ma: 8.6N·m, Mb: 12.2N·m, Mc: 16.7N·m
Ambient operating temperature, humidity	0 to 40°C, 85% RH or less (Non-condensing)

(*1) Assumes a standard rated life of 5000km.

• Reference for overhang load lengths / Ma: 120mm or less, Mb, Mc: 120mm or less

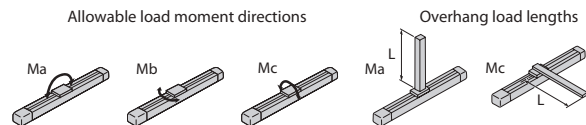

(Note)

The operational life will vary depending on operation and installation conditions. Please refer to the RC General Catalog for details on operational life, allowable moment direction, and overhang load length.

Dimensions

CAD drawings can be downloaded from the website.

www.robocylinder.de



- *1 When the slider is returning to its home position, please be careful of interference from surrounding objects, as it will travel until it reaches the ME.
- ME: Mechanical end
- SE: Stroke end
- *2 Please see P. 48 for slider roller specification (SR).

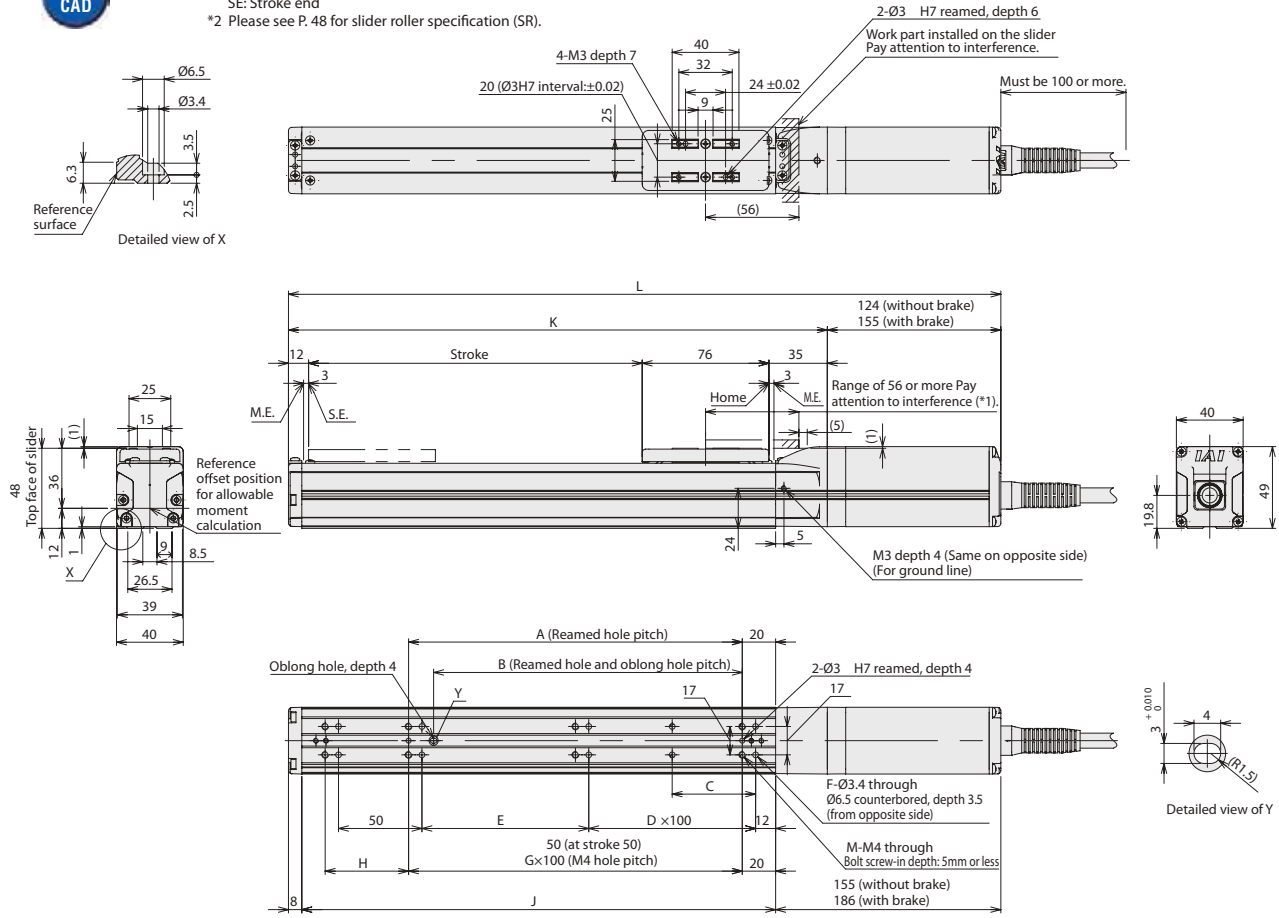

■ Cable Exit Direction (Option)

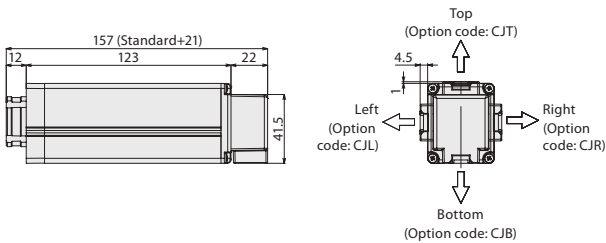

■ Dimensions and Mass by Stroke

Stroke	50	100	150	200	250	300	350	400	450	500
L	Without brake	297	347	397	447	497	547	597	647	697
	With brake	328	378	428	478	528	578	628	678	728
A	50	100	100	200	200	300	300	400	400	500
B	35	85	85	185	185	285	285	385	385	485
C	25	50	50	50	50	50	50	50	50	50
D	0	0	1	1	2	2	3	3	4	4
E	50	100	50	100	50	100	50	100	50	100
F	8	8	10	10	12	12	14	14	16	16
G	0	1	1	2	2	3	3	4	4	5
H	50	50	100	50	100	50	100	50	100	50
J	134	184	234	284	334	384	434	484	534	584
K	173	223	273	323	373	423	473	523	573	623
M	6	6	6	8	8	10	10	12	12	14
Mass (kg)	Without brake	1.0	1.1	1.2	1.3	1.3	1.4	1.5	1.6	1.7
	With brake	1.2	1.3	1.4	1.5	1.5	1.6	1.7	1.8	1.9

Applicable Controllers

The RCP5 series actuators can be operated by the controllers indicated below. Please select the type depending on your intended use.

Name	External view	Model number	Max. number of controlled axes	Maximum number of positioning points	Input power	Reference page
Positioner type (High-output specification)		PCON-CA-35PWAI-①-2-0	1	512 points	DC24V	→P. 69
Pulse train type (High-output specification)		PCON-CA-35PWAI-PL②-2-0				
Field network type (High-output specification)		PCON-CA-35PWAI-③-0-0				
Solenoid valve multi-axis type (PIO specification)		MSEP-④-⑤-⑥-⑦-2-0	C: 8 (4 when high-output enabled) LC: 6 (3 when high-output enabled)	3 points	DC24V	→P. 77
Positioner multi-axis type (Field network specification)		MSEP-④-⑤-⑥-⑦-0-0				
Program control multi-axis safety category type		MSEL-PG-1-35PWAI-①-2-4	4	30000 points	Single-phase AC 100V~230V	→P. 87
Program control multi-axis safety category type (w/ network board)		MSEL-PG-1-35PWAI-③-0-4				

*Above MSEL models are for single-axis specification *① I/O type (NP/PN) *③ Number of axes
 *② Field network specification code *④ C or LC *⑤ N (NPN specification) or P (PNP specification) code
 *The high output enabled operation is only available when the "High-output setting specs" is selected in the MSEP-C/LC.

RCP5-SA6C

RoboCylinder, Slider Type, Motor Unit Coupled, Actuator Width 58mm, 24V Pulse Motor

Model	RCP5	SA6C	WA	42P				P3		
Specification	Series	Type	Encoder type	Motor type	Lead	Stroke	Applicable controllers	Cable length	Options	
Items			WA: Battery-less absolute specification	42P: Pulse motor, size 42□	20: 20mm 12: 12mm 6: 6mm 3: 3mm	50: 50mm 800: 800mm (Every 50mm)	P3: PCON-CA MSEP MSEL	N: No cable P: 1m S: 3m M: 5m X□: Specified length R□: Robot cable	Please refer to the options table below.	

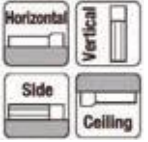

* Depending on the model, there may be some limitations to using the vertical, side, and ceiling mount positions. Please refer to P.59 for details.



Correlation Diagrams of Speed and Payload

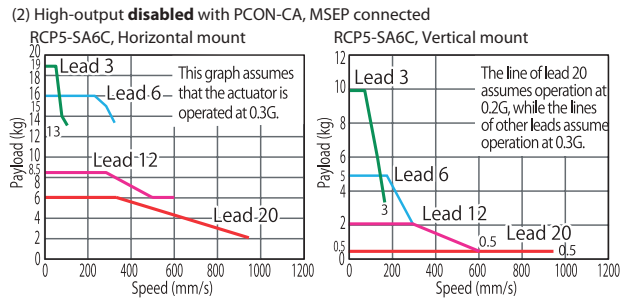
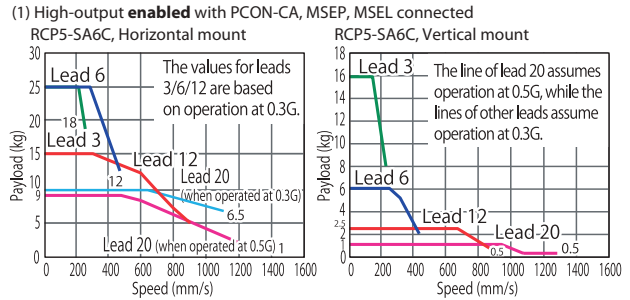

POINT
Note on selection

(1) The actuator specification displays the payload's maximum value, but it will vary depending on the acceleration. Please refer to the "Selection Guidelines" (RCP5 Payload by Speed/Acceleration Table) on P. 61.

(2) Please refer to P. 59 for push-motion operation.

Actuator Specifications

Lead and Payload

Model number	Lead (mm)	Connected controller	Maximum payload		Stroke (mm)
			Horizontal (kg)	Vertical (kg)	
RCP5-SA6C-WA-42P-20-①-P3-②-③	20	High-output enabled	10	1	50~800 (Every 50mm)
		High-output disabled	6	0.5	
RCP5-SA6C-WA-42P-12-①-P3-②-③	12	High-output enabled	15	2.5	
		High-output disabled	8.5	2	
RCP5-SA6C-WA-42P-6-①-P3-②-③	6	High-output enabled	25	6	
		High-output disabled	16	5	
RCP5-SA6C-WA-42P-3-①-P3-②-③	3	High-output enabled	25	12	
		High-output disabled	19	10	

Legend: ① Stroke ② Cable length ③ Options

Stroke and Maximum Speed

Values in brackets <> are for vertical use. (Unit: mm/s)

Lead (mm)	Connected controller	50~400 (Every 50mm)	450 (mm)	500 (mm)	550 (mm)	600 (mm)	650 (mm)	700 (mm)	750 (mm)	800 (mm)
20	High-output enabled	1,440 <1280>	1,335 <1280>	1130	970	840	735	650	575	
	High-output disabled	960				840	735	650	575	
12	High-output enabled	900	885	735	620	535	460	405	355	315
	High-output disabled	600				535	460	405	355	315
6	High-output enabled	450	435	365	305	265	230	200	175	155
	High-output disabled	300				265	230	200	175	155
3	High-output enabled	225	215	180	150	130	115	100	85	75
	High-output disabled	150				130	115	100	85	75

Cable Length

Type	Cable code
Standard type	P (1m)
	S (3m)
	M (5m)
Special length	X06 (6m) ~X10 (10m)
	X11 (11m) ~X15 (15m)
	X16 (16m) ~X20 (20m)
Robot cable	R01 (1m) ~R03 (3m)
	R04 (4m) ~R05 (5m)
	R06 (6m) ~R10 (10m)
	R11 (11m) ~R15 (15m)
	R16 (16m) ~R20 (20m)

Options

Name	Option code	Reference page
Brake	B	→P. 11
Cable exit direction (Top)	CJT	→P. 11
Cable exit direction (Right)	CJR	→P. 11
Cable exit direction (Left)	CJL	→P. 11
Cable exit direction (Bottom)	CJB	→P. 11
Slider roller specification	SR	→P. 11
Non-motor end specification	NM	→P. 11

Actuator Specifications

Item	Description
Drive system	Ball screw Ø10mm, rolled C10
Positioning repeatability (*1)	±0.02mm [±0.03mm]
Lost motion	0.1mm or less
Base	Material: Aluminum with white alumite treatment
Dynamic allowable moment (*2)	Ma: 11.6N·m, Mb: 16.6N·m, Mc: 24.6N·m
Static allowable moment	Ma: 38.3N·m, Mb: 54.7N·m, Mc: 81N·m
Ambient operating temperature, humidity	0 to 40°C, 85% RH or less (Non-condensing)

(*1) The values in brackets [] are for Lead 20.

(*2) Assumes a standard rated life of 5000km.

• Reference for overhang load lengths / Ma: 150mm or less, Mb, Mc: 150mm or less

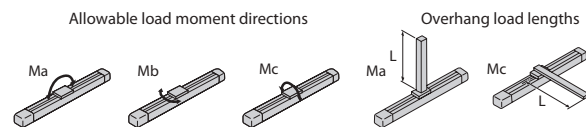

(Note)

The operational life will vary depending on operation and installation conditions. Please refer to the RC General Catalog for details on operational life, allowable moment direction, and overhang load length.

Dimensions

CAD drawings can be downloaded from the website.

www.robocylinder.de



- *1 When the slider is returning to its home position, please be careful of interference from surrounding objects, as it will travel until it reaches the ME.
- ME: Mechanical end
- SE: Stroke end
- *2 Please see P. 50 for slider roller specification (SR).

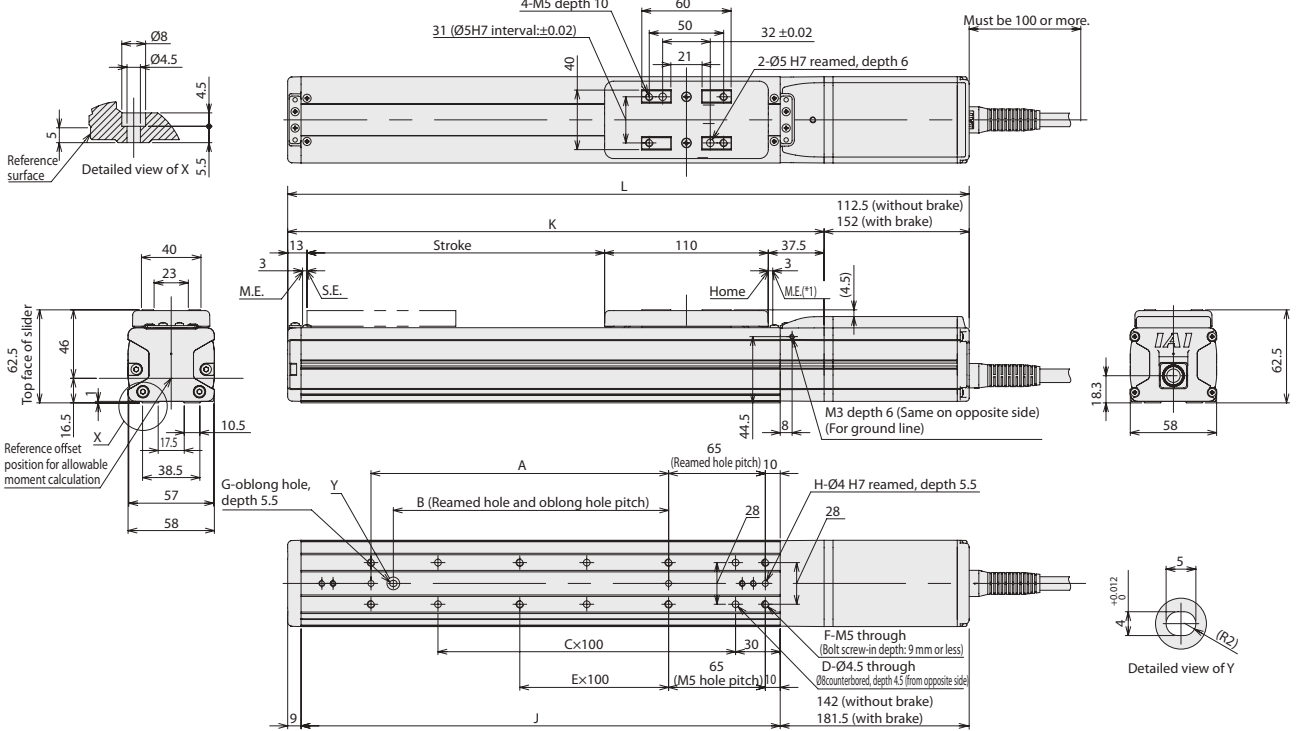

■ Cable Exit Direction (Option)

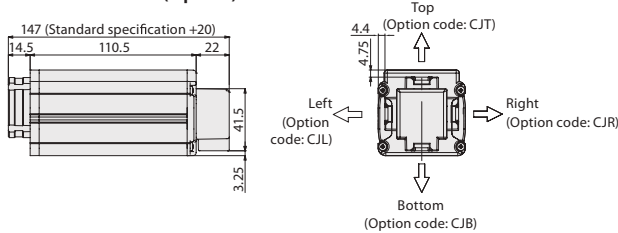

■ Dimensions and Mass by Stroke

Stroke	50	100	150	200	250	300	350	400	450	500	550	600	650	700	750	800	
L	Without brake	323	373	423	473	523	573	623	673	723	773	823	873	923	973	1023	1073
	With brake	362.5	412.5	462.5	512.5	562.5	612.5	662.5	712.5	762.5	812.5	862.5	912.5	962.5	1012.5	1062.5	1112.5
A	0	100	100	200	200	300	300	400	400	500	500	600	600	700	700	800	
B	0	85	85	185	185	285	285	385	385	485	485	585	585	685	685	785	
C	1	1	2	2	3	3	4	4	5	5	6	6	7	7	8	8	
D	4	4	6	6	8	8	10	10	12	12	14	14	16	16	18	18	
E	0	0	0	1	1	2	2	3	3	4	4	5	5	6	6	7	
F	4	6	6	8	8	10	10	12	12	14	14	16	16	18	18	20	
G	0	1	1	1	1	1	1	1	1	1	1	1	1	1	1	1	
H	2	3	3	3	3	3	3	3	3	3	3	3	3	3	3	3	
J	172	222	272	322	372	422	472	522	572	622	672	722	772	822	872	922	
K	210.5	260.5	310.5	360.5	410.5	460.5	510.5	560.5	610.5	660.5	710.5	760.5	810.5	860.5	910.5	960.5	
Mass (kg)	Without brake	1.7	1.8	2.0	2.2	2.4	2.5	2.7	2.9	3.1	3.2	3.4	3.6	3.8	3.9	4.1	4.3
	With brake	1.9	2.0	2.2	2.4	2.6	2.7	2.9	3.1	3.3	3.4	3.6	3.8	4.0	4.1	4.3	4.5

Applicable Controllers

The RCP5 series actuators can be operated by the controllers indicated below. Please select the type depending on your intended use.

Name	External view	Model number	Max. number of controlled axes	Maximum number of positioning points	Input power	Reference page
Positioner type (High-output specification)		PCON-CA-42PWAI-①-2-0	1	512 points	DC24V	→P. 69
Pulse train type (High-output specification)		PCON-CA-42PWAI-PL②-2-0				
Field network type (High-output specification)		PCON-CA-42PWAI-③-0-0				
Solenoid valve multi-axis type (PIO specification)		MSEP-④-⑤-⑥-⑦-⑧-⑨-⑩-⑪-⑫-⑬-⑭-⑮-⑯-⑰-⑱-⑲-⑳-㉑-㉒-㉓-㉔-㉕-㉖-㉗-㉘-㉙-㉚-㉛-㉜-㉝-㉞-㉟-㊱-㊲-㊳-㊴-㊵-㊶-㊷-㊸-㊹-㊺-㊻-㊼-㊽-㊾-㊿-①-②-③-④-⑤-⑥-⑦-⑧-⑨-⑩-⑪-⑫-⑬-⑭-⑮-⑯-⑰-⑱-⑲-⑳-㉑-㉒-㉓-㉔-㉕-㉖-㉗-㉘-㉙-㉚-㉛-㉜-㉝-㉞-㉟-㊱-㊲-㊳-㊴-㊵-㊶-㊷-㊸-㊹-㊺-㊻-㊼-㊽-㊾-㊿	C: 8 (4 when high-output enabled)	3 points	→P. 77	
Positioner multi-axis type (Field network specification)		MSEP-④-⑤-⑥-⑦-⑧-⑨-⑩-⑪-⑫-⑬-⑭-⑮-⑯-⑰-⑱-⑲-⑳-㉑-㉒-㉓-㉔-㉕-㉖-㉗-㉘-㉙-㉚-㉛-㉜-㉝-㉞-㉟-㊱-㊲-㊳-㊴-㊵-㊶-㊷-㊸-㊹-㊺-㊻-㊼-㊽-㊾-㊿	LC: 6 (3 when high-output enabled)			
Program control multi-axis safety category type		MSEL-PG-1-42PWAI-①-2-4	4	30000 points	Single-phase AC 100V~230V	→P. 87
Program control multi-axis safety category type (w/ network board)		MSEL-PG-1-42PWAI-③-0-4				

*Above MSEL models are for single-axis specification *① I/O type (NP/PN) *③ Number of axes
 *④ Field network specification code *⑤ C or LC *⑥ N (NPN specification) or P (PNP specification) code
 *The high output enabled operation is only available when the "High-output setting specs" is selected in the MSEP-C/LC.

RCP5-SA7C

RoboCylinder, Slider Type, Motor Unit Coupled, Actuator Width 73mm, 24V Pulse Motor

Model	RCP5	SA7C	WA	56P				P3		
Specification	Series	Type	Encoder type	Motor type	Lead	Stroke	Applicable controllers	Cable length	Options	
Items			WA: Battery-less absolute specification	56P: Pulse motor, size 56□	24: 24mm 16: 16mm 8: 8mm 4: 4mm	50: 50mm 800: 800mm (Every 50mm)	P3: PCON-CA MSEP MSEL	N: No cable P: 1m S: 3m M: 5m X□: Specified length R□: Robot cable	Please refer to the options table below.	



* Depending on the model, there may be some limitations to using the vertical, side, and ceiling mount positions. Please refer to P.59 for details.



Correlation Diagrams of Speed and Payload

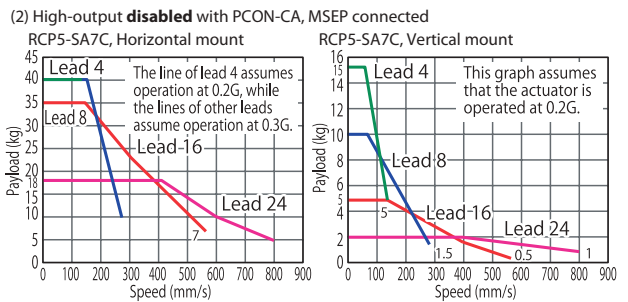
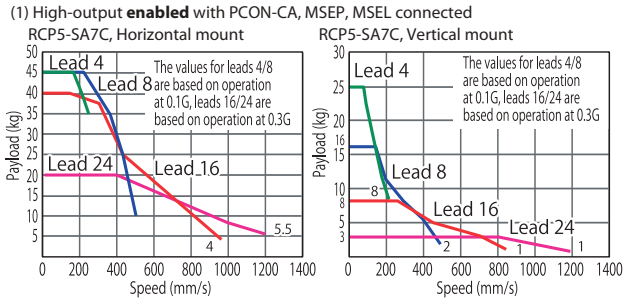

POINT
Note on selection

(1) The actuator specification displays the payload's maximum value, but it will vary depending on the acceleration. Please refer to the "Selection Guidelines" (RCP5 Payload by Speed/Acceleration Table) on P. 61.

(2) Please refer to P. 59 for push-motion operation.

Actuator Specifications

Lead and Payload

Model number	Lead (mm)	Connected controller	Maximum payload		Stroke (mm)
			Horizontal (kg)	Vertical (kg)	
RCP5-SA7C-WA-56P-24-①-P3-②-③	24	High-output enabled	20	3	50~800 (Every 50mm)
		High-output disabled	18	2	
RCP5-SA7C-WA-56P-16-①-P3-②-③	16	High-output enabled	40	8	
		High-output disabled	35	5	
RCP5-SA7C-WA-56P-8-①-P3-②-③	8	High-output enabled	45	16	
		High-output disabled	40	10	
RCP5-SA7C-WA-56P-4-①-P3-②-③	4	High-output enabled	45	25	
		High-output disabled	40	15	

Legend: ① Stroke ② Cable length ③

Stroke and Maximum Speed

Values in brackets <> are for vertical use. (Unit: mm/s)

Lead (mm)	Connected controller	50~550 (Every 50mm)	600 (mm)	650 (mm)	700 (mm)	750 (mm)	800 (mm)
24	High-output enabled		1200	1145	1000	885	785
	High-output disabled		800				785
16	High-output enabled	980 <840>	875 <840>	755	660	585	520
	High-output disabled	560					520
8	High-output enabled	490	430	375	325	290	255
	High-output disabled	280					255
4	High-output enabled	245 <210>	215 <210>	185	160	140	125
	High-output disabled	140					125

Cable Length

Type	Cable code
Standard type	P (1m)
	S (3m)
	M (5m)
Special length	X06 (6m) ~X10 (10m)
	X11 (11m) ~X15 (15m)
	X16 (16m) ~X20 (20m)
Robot cable	R01 (1m) ~R03 (3m)
	R04 (4m) ~R05 (5m)
	R06 (6m) ~R10 (10m)
	R11 (11m) ~R15 (15m)
	R16 (16m) ~R20 (20m)

Options

Name	Option code	Reference page
Brake	B	→P. 11
Cable exit direction (Top)	CJT	→P. 11
Cable exit direction (Right)	CJR	→P. 11
Cable exit direction (Left)	CJL	→P. 11
Cable exit direction (Bottom)	CJB	→P. 11
Slider roller specification	SR	→P. 11
Non-motor end specification	NM	→P. 11

Actuator Specifications

Item	Description
Drive system	Ball screw Ø12mm, rolled C10
Positioning repeatability (*1)	±0.02mm [±0.03mm]
Lost motion	0.1mm or less
Base	Material: Aluminum with white alumite treatment
Dynamic allowable moment (*2)	Ma: 11.6N·m, Mb: 16.6N·m, Mc: 33.7N·m
Static allowable moment	Ma: 51.2N·m, Mb: 73.1N·m, Mc: 148N·m
Ambient operating temperature, humidity	0 to 40°C, 85% RH or less (Non-condensing)

(*1) The values in brackets [] are for Lead 24.

(*2) Assumes a standard rated life of 5000km.

• Reference for overhang load lengths / Ma: 230mm or less, Mb, Mc: 230mm or less

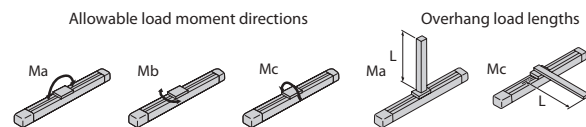

(Note)

The operational life will vary depending on operation and installation conditions. Please refer to the RC General Catalog for details on operational life, allowable moment direction, and overhang load length.

Dimensions

CAD drawings can be downloaded from the website.

www.robocylinder.de

2/3D CAD

- *1 When the slider is returning to its home position, please be careful of interference from surrounding objects, as it will travel until it reaches the ME.
- ME: Mechanical end
- SE: Stroke end
- *2 Please see P. 52 for slider roller specification (SR).

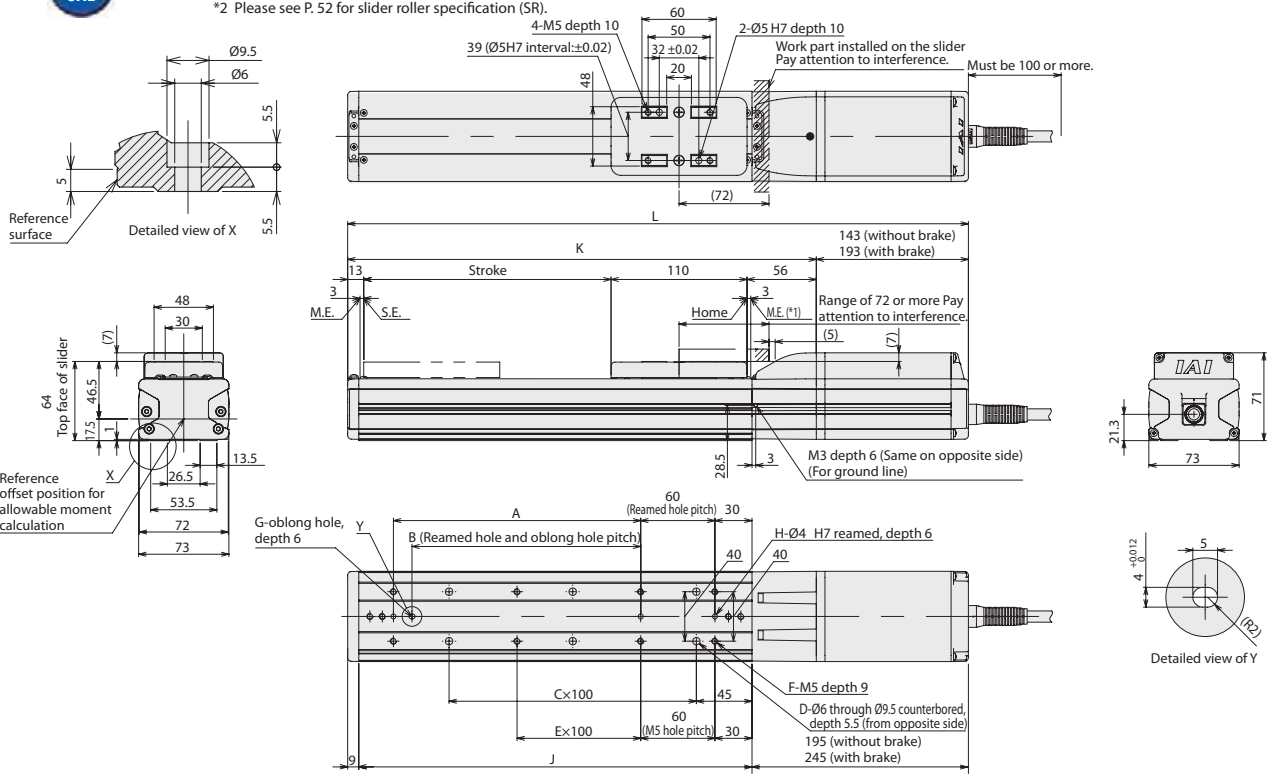

■ Cable Exit Direction (Option)

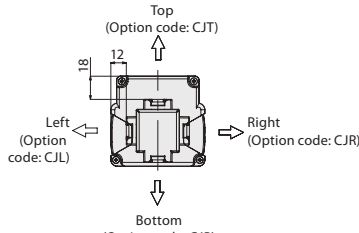
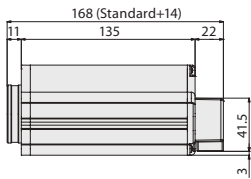

■ Dimensions and Mass by Stroke

Stroke	50	100	150	200	250	300	350	400	450	500	550	600	650	700	750	800
L	Without brake	372	422	472	522	572	622	672	722	772	822	872	922	1,022	1,072	1,122
	With brake	422	472	522	572	622	672	722	772	822	872	922	972	1,022	1,072	1,122
A	0	100	100	200	200	300	300	400	400	500	500	600	600	700	700	800
B	0	85	85	185	185	285	285	385	385	485	485	585	585	685	685	785
C	1	1	2	2	3	3	4	4	5	5	6	6	7	7	8	8
D	4	4	6	6	8	8	10	10	12	12	14	14	16	16	18	18
E	0	0	0	1	1	2	2	3	3	4	4	5	5	6	6	7
F	4	6	6	8	8	10	10	12	12	14	14	16	16	18	18	20
G	0	1	1	1	1	1	1	1	1	1	1	1	1	1	1	1
H	2	3	3	3	3	3	3	3	3	3	3	3	3	3	3	3
J	168	218	268	318	368	418	468	518	568	618	668	718	768	818	868	918
K	229	279	329	379	429	479	529	579	629	679	729	779	829	879	929	979
Mass (kg)	Without brake	3.0	3.2	3.5	3.7	3.9	4.1	4.4	4.6	4.8	5.0	5.3	5.5	5.7	5.9	6.1
	With brake	3.5	3.7	4.0	4.2	4.4	4.6	4.9	5.1	5.3	5.5	5.8	6.0	6.2	6.4	6.6

Applicable Controllers

The RCP5 series actuators can be operated by the controllers indicated below. Please select the type depending on your intended use.

Name	External view	Model number	Max. number of controlled axes	Maximum number of positioning points	Input power	Reference page
Positioner type (High-output specification)		PCON-CA-56PWAI-①-2-0	1	512 points	DC24V	→P. 69
Pulse train type (High-output specification)		PCON-CA-56PWAI-PL②-2-0				
Field network type (High-output specification)		PCON-CA-56PWAI-③-0-0				
Solenoid valve multi-axis type (PIO specification)		MSEP-④-⑤---①-2-0	C: 8 (4 when high-output enabled) LC: 6 (3 when high-output enabled)	3 points	DC24V	→P. 77
Positioner multi-axis type (Field network specification)		MSEP-④-⑤---③-0-0				
Program control multi-axis safety category type		MSEL-PG-1-56PWAI-①-2-4	4	30000 points	Single-phase AC 100V~230V	→P. 87
Program control multi-axis safety category type (w/ network board)		MSEL-PG-1-56PWAI-③-0-4				

*Above MSEL models are for single-axis specification *① I/O type (NP/PN) *③ Number of axes
 *④ Field network specification code *⑤ C or LC *② V (NPN specification) or P (PNP specification) code
 *The high output enabled operation is only available when the "High-output setting specs" is selected in the MSEP-C/LC.

RCP5-SA4R

RoboCylinder, Slider Type, Side-mounted Motor Type, Actuator Width 40mm, 24V Pulse Motor

Model	RCP5	SA4R	WA	35P				P3		
Specification Items	Series	Type	Encoder type	Motor type	Lead	Stroke	Applicable controllers	Cable length	Options	
			WA: Battery-less absolute specification	35P: Pulse motor, size 35□	16: 16mm 10: 10mm 5: 5mm 2.5: 2.5mm	50: 50mm 500: 500mm (Every 50mm)	P3: PCON-CA MSEP MSEL	N: No cable P: 1m S: 3m M: 5m X□: Specified length R□: Robot cable	Please refer to the options table below.	

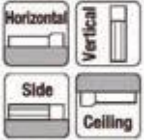

* Depending on the model, there may be some limitations to using the vertical, side, and ceiling mount positions. Please refer to P.59 for details.



The figure above is the motor side-mounted to the left (ML).



- The actuator specification displays the payload's maximum value, but it will vary depending on the acceleration. Please refer to the "Selection Guidelines" (RCP5 Payload by Speed/Acceleration Table) on P. 63.
- Please refer to P. 59 for push-motion operation.

Correlation Diagrams of Speed and Payload

(1) High-output **enabled** with PCON-CA, MSEP, MSEL connected

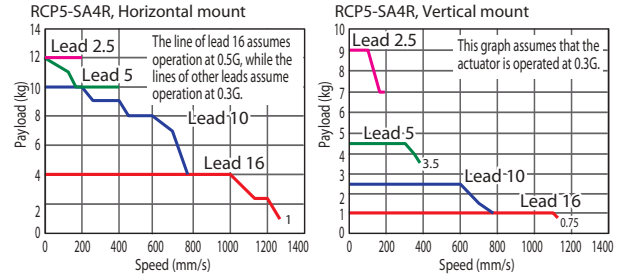

(2) High-output **disabled** with PCON-CA, MSEP connected

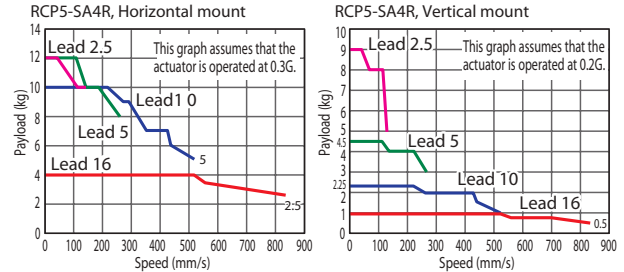

Actuator Specifications

Lead and Payload

Model number	Lead (mm)	Connected controller	Maximum payload		Stroke (mm)
			Horizontal (kg)	Vertical (kg)	
RCP5-SA4R-WA-35P-16-①-P3-②-③	16	High-output enabled	4	1	50~500 (Every 50mm)
		High-output disabled			
RCP5-SA4R-WA-35P-10-①-P3-②-③	10	High-output enabled	10	2.25	
		High-output disabled			
RCP5-SA4R-WA-35P-5-①-P3-②-③	5	High-output enabled	12	4.5	
		High-output disabled			
RCP5-SA4R-WA-35P-2.5-①-P3-②-③	2.5	High-output enabled	12	9	
		High-output disabled			

Legend: ① Stroke ② Cable length ③ Options

Stroke and Maximum Speed

(Unit: mm/s)

Lead (mm)	Connected controller	50~400 (Every 50mm)	450 (mm)	500 (mm)
16	High-output enabled	1260	1060	875
	High-output disabled	840		
10	High-output enabled	785	675	555
	High-output disabled	525		
5	High-output enabled	390	330	275
	High-output disabled	260		
2.5	High-output enabled	195	165	135
	High-output disabled	130		

Cable Length

Type	Cable code
Standard type	P (1m)
	S (3m)
	M (5m)
Special length	X06 (6m) ~X10 (10m)
	X11 (11m) ~X15 (15m)
	X16 (16m) ~X20 (20m)
Robot cable	R01 (1m) ~R03 (3m)
	R04 (4m) ~R05 (5m)
	R06 (6m) ~R10 (10m)
	R11 (11m) ~R15 (15m)
	R16 (16m) ~R20 (20m)

Options

Name	Option code	Reference page
Brake	B	→P. 11
Cable exit direction (Top)	CJT	→P. 11
Cable exit direction (Outside)	CJO	→P. 11
Cable exit direction (Bottom)	CJB	→P. 11
Motor side-mounted to the left (Standard)	ML	→P. 11
Motor side-mounted to the right	MR	→P. 11
Slider roller specification	SR	→P. 11
Non-motor end specification	NM	→P. 11

Actuator Specifications

Item	Description
Drive system	Ball screw Ø8mm, rolled C10
Positioning repeatability	±0.02mm
Lost motion	0.1mm or less
Base	Material: Aluminum with white alumite treatment
Dynamic allowable moment (*1)	Ma: 4.98N·m, Mb: 7.11N·m, Mc: 9.68N·m
Static allowable moment	Ma: 8.6N·m, Mb: 12.2N·m, Mc: 16.7N·m
Ambient operating temperature, humidity	0 to 40°C, 85% RH or less (Non-condensing)

(*1) Assumes a standard rated life of 5000km.

• Reference for overhang load lengths / Ma: 120mm or less, Mb, Mc: 120mm or less

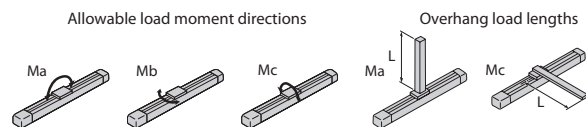

(Note)

The operational life will vary depending on operation and installation conditions. Please refer to the RC General Catalog for details on operational life, allowable moment direction, and overhang load length.

Dimensions

CAD drawings can be downloaded from the website.

www.robocylinder.de



- *1 When the slider is returning to its home position, please be careful of interference from surrounding objects, as it will travel until it reaches the ME.
- ME: Mechanical end
SE: Stroke end
- *2 Please see P. 48 for slider roller specification (SR).

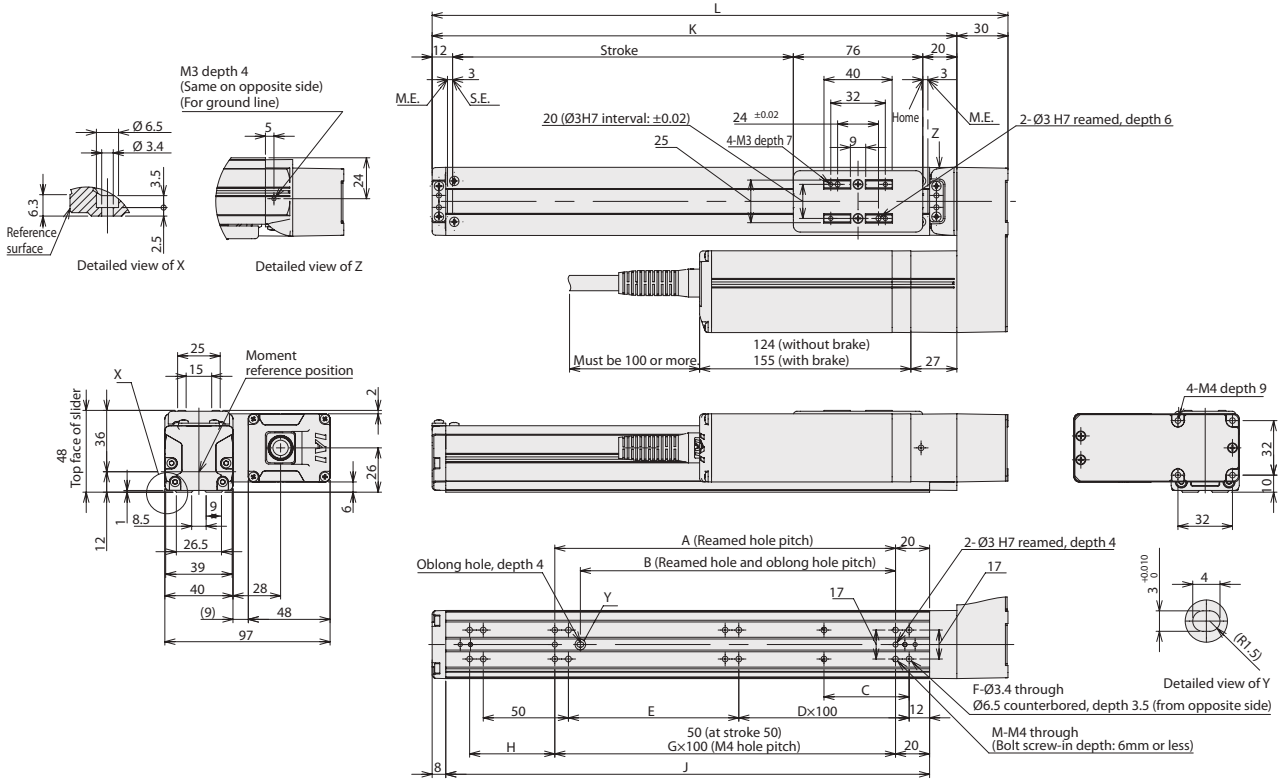

■ Cable Exit Direction (Option)

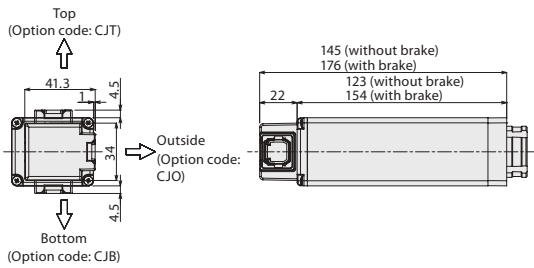

*The figure above is for the motor side-mounted to the left (ML).

■ Dimensions and Mass by Stroke

Stroke	50	100	150	200	250	300	350	400	450	500
L	188	238	288	338	388	438	488	538	588	638
A	50	100	100	200	200	300	300	400	400	500
B	35	85	85	185	185	285	285	385	385	485
C	25	50	50	50	50	50	50	50	50	50
D	0	0	1	1	2	2	3	3	4	4
E	50	100	50	100	50	100	50	100	50	100
F	8	8	10	10	12	12	14	14	16	16
G	-	1	1	2	2	3	3	4	4	5
H	50	50	100	50	100	50	100	50	100	50
J	134	184	234	284	334	384	434	484	534	584
K	158	208	258	308	358	408	458	508	558	608
M	6	6	6	8	8	10	10	12	12	14
Mass (kg)										
Without brake	1.3	1.4	1.5	1.6	1.6	1.7	1.8	1.9	2.0	2.1
With brake	1.5	1.6	1.7	1.8	1.8	1.9	2.0	2.1	2.2	2.3

Applicable Controllers

The RCP5 series actuators can be operated by the controllers indicated below. Please select the type depending on your intended use.

Name	External view	Model number	Max. number of controlled axes	Maximum number of positioning points	Input power	Reference page
Positioner type (High-output specification)		PCON-CA-35PWAI-①-2-0	1	512 points	DC24V	→P. 69
Pulse train type (High-output specification)		PCON-CA-35PWAI-PL②-2-0				
Field network type (High-output specification)		PCON-CA-35PWAI-③-0-0				
Solenoid valve multi-axis type (PIO specification)		MSEP-④-⑤---①-2-0	C: 8 (4 when high-output enabled) LC: 6 (3 when high-output enabled)	3 points		→P. 77
Positioner multi-axis type (Field network specification)		MSEP-④-⑤---③-0-0				
Program control multi-axis safety category type		MSEL-PG-1-35PWAI-①-2-4	4	30000 points	Single-phase AC 100V~230V	→P. 87
Program control multi-axis safety category type (w/ network board)		MSEL-PG-1-35PWAI-③-0-4				

*Above MSEL models are for single-axis specification
 *① I/O type (NP/PN)
 *② Field network specification code
 *③ C or LC
 *④ Number of axes
 *⑤ N (NPN specification) or P (PNP specification) code
 *The high output enabled operation is only available when the "High-output setting specs" is selected in the MSEP-C/LC.

RCP5-SA6R

RoboCylinder, Slider Type, Side-mounted Motor Type, Actuator Width 58mm, 24V Pulse Motor

Model	RCP5	SA6R	WA	42P				P3		
Specification	Series	Type	Encoder type	Motor type	Lead	Stroke	Applicable controllers	Cable length	Options	
Items			WA: Battery-less absolute specification	42P: Pulse motor, size 42□	20: 20mm 12: 12mm 6: 6mm 3: 3mm	50: 50mm 800: 800mm (Every 50mm)	P3: PCON-CA MSEP MSEL	N: No cable P: 1m S: 3m M: 5m X□□: Specified length R□□: Robot cable	Please refer to the options table below.	

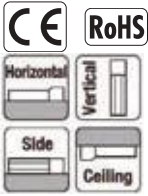

* Depending on the model, there may be some limitations to using the vertical, side, and ceiling mount positions. Please refer to P.59 for details.



The figure above is the motor side-mounted to the left (ML).

POINT
Note on selection

- The actuator specification displays the payload's maximum value, but it will vary depending on the acceleration. Please refer to the "Selection Guidelines" (RCP5 Payload by Speed/Acceleration Table) on P. 63.
- Please refer to P. 59 for push-motion operation.

Correlation Diagrams of Speed and Payload

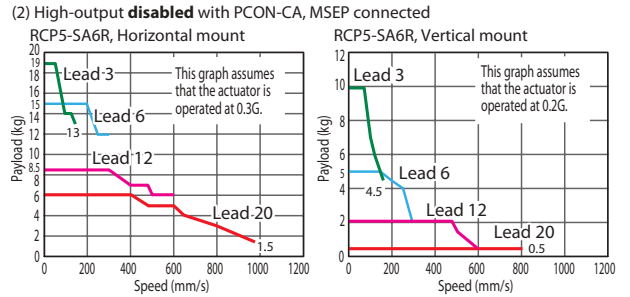
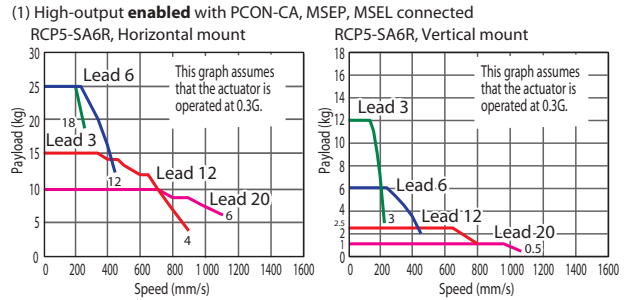

Actuator Specifications

Lead and Payload

Model number	Lead (mm)	Connected controller	Maximum payload		Stroke (mm)
			Horizontal (kg)	Vertical (kg)	
RCP5-SA6R-WA-42P-20-①-P3-②-③	20	High-output enabled	10	1	50~800 (Every 50mm)
		High-output disabled	6	0.5	
RCP5-SA6R-WA-42P-12-①-P3-②-③	12	High-output enabled	15	2.5	
		High-output disabled	8.5	2	
RCP5-SA6R-WA-42P-6-①-P3-②-③	6	High-output enabled	25	6	
		High-output disabled	16	5	
RCP5-SA6R-WA-42P-3-①-P3-②-③	3	High-output enabled	25	12	
		High-output disabled	19	10	

Legend: ① Stroke ② Cable length ③ Options

Stroke and Maximum Speed

Values in brackets <> are for vertical use. (Unit: mm/s)

Lead (mm)	Connected controller	Maximum Speed (mm/s)							
		50~400 (Every 50mm)	450 (mm)	500 (mm)	550 (mm)	600 (mm)	650 (mm)	700 (mm)	750 (mm)
20	High-output enabled	1280		1130	970	840	735	650	575
	High-output disabled	960				840	735	650	575
12	High-output enabled	900 (<800>)	885 (<800>)	735	620	535	460	405	315
	High-output disabled	600				535	460	405	315
6	High-output enabled	450	435	365	305	265	230	200	175
	High-output disabled	300				265	230	200	175
3	High-output enabled	225	215	180	150	130	115	100	85
	High-output disabled	150				130	115	100	85

Cable Length

Type	Cable code
Standard type	P (1m)
	S (3m)
	M (5m)
Special length	X06 (6m) ~X10 (10m)
	X11 (11m) ~X15 (15m)
	X16 (16m) ~X20 (20m)
	R01 (1m) ~R03 (3m)
Robot cable	R04 (4m) ~R05 (5m)
	R06 (6m) ~R10 (10m)
	R11 (11m) ~R15 (15m)
	R16 (16m) ~R20 (20m)

Options

Name	Option code	Reference page
Brake	B	→P. 11
Cable exit direction (Top)	CJT	→P. 11
Cable exit direction (Outside)	CJO	→P. 11
Cable exit direction (Bottom)	CJB	→P. 11
Motor side-mounted to the left (Standard)	ML	→P. 11
Motor side-mounted to the right	MR	→P. 11
Slider roller specification	SR	→P. 11
Non-motor end specification	NM	→P. 11

Actuator Specifications

Item	Description
Drive system	Ball screw Ø10mm, rolled C10
Positioning repeatability (*1)	±0.02mm [±0.03mm]
Lost motion	0.1mm or less
Base	Material: Aluminum with white alumite treatment
Dynamic allowable moment (*2)	Ma: 11.6N·m, Mb: 16.6N·m, Mc: 24.6N·m
Static allowable moment	Ma: 38.3N·m, Mb: 54.7N·m, Mc: 81N·m
Ambient operating temperature, humidity	0 to 40°C, 85% RH or less (Non-condensing)

(*1) The values in brackets [] are for Lead 20.

(*2) Assumes a standard rated life of 5000km.

• Reference for overhang load lengths / Ma: 150mm or less, Mb, Mc: 150mm or less

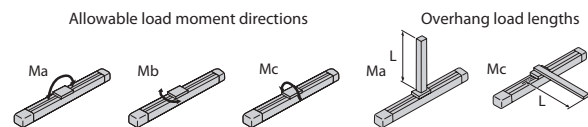

(Note)

The operational life will vary depending on operation and installation conditions. Please refer to the RC General Catalog for details on operational life, allowable moment direction, and overhang load length.

Dimensions

CAD drawings can be downloaded from the website.

www.robocylinder.de

2/3D
CAD

*1 When the slider is returning to its home position, please be careful of interference from surrounding objects, as it will travel until it reaches the ME.

ME: Mechanical end
SE: Stroke end

*2 Please see P. 50 for slider roller specification (SR).

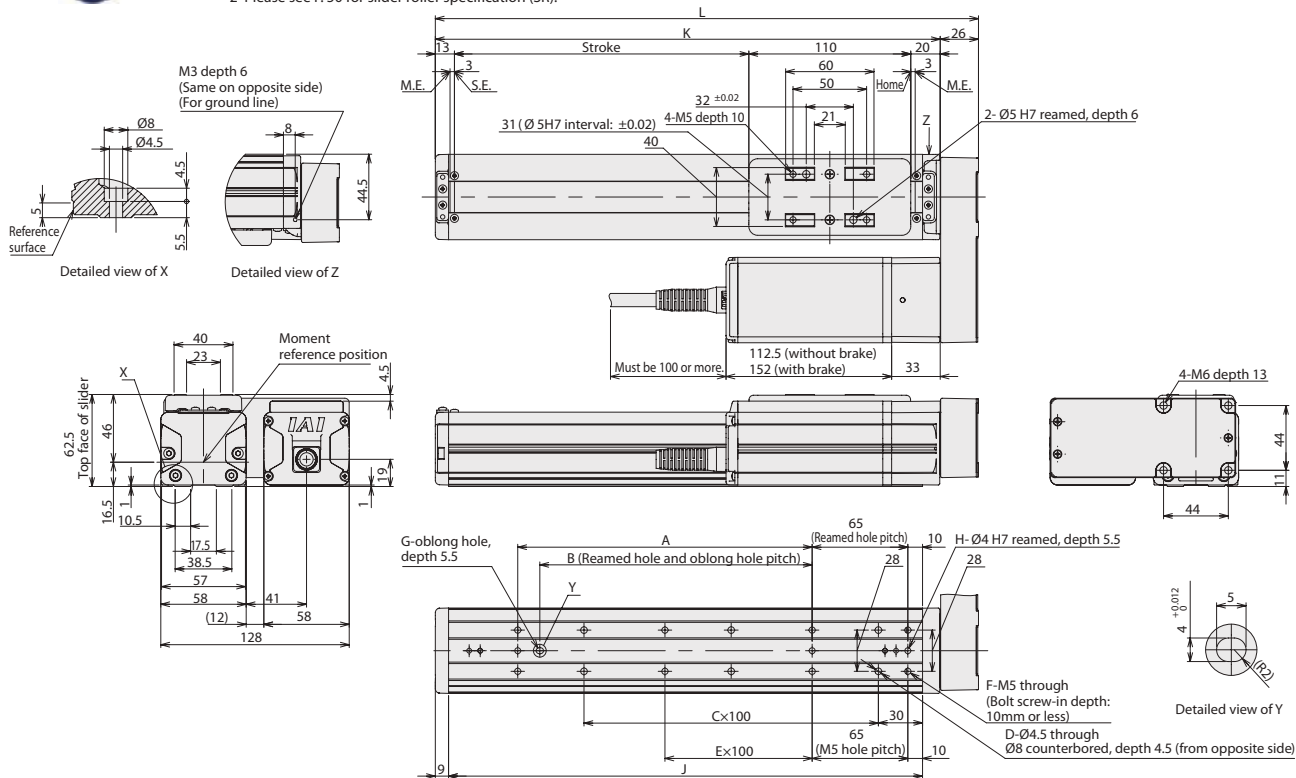

■ Cable Exit Direction (Option)

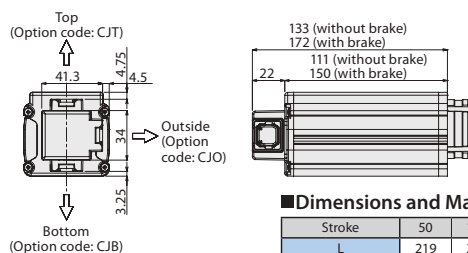

*The figure above is for the motor side-mounted to the left (ML).

■ Dimensions and Mass by Stroke

Stroke	50	100	150	200	250	300	350	400	450	500	550	600	650	700	750	800	
L	219	269	319	369	419	469	519	569	619	669	719	769	819	869	919	969	
A	0	100	100	200	200	300	300	400	400	500	500	600	600	700	700	800	
B	0	85	85	185	185	285	285	385	385	485	485	585	585	685	685	785	
C	1	1	2	2	3	3	4	4	5	5	6	6	7	7	8	8	
D	4	4	6	6	8	8	10	10	12	12	14	14	16	16	18	18	
E	0	0	0	1	1	2	2	3	3	4	4	5	5	6	6	7	
F	4	6	6	8	8	10	10	12	12	14	14	16	16	18	18	20	
G	0	1	1	1	1	1	1	1	1	1	1	1	1	1	1	1	
H	2	3	3	3	3	3	3	3	3	3	3	3	3	3	3	3	
J	172	222	272	322	372	422	472	522	572	622	672	722	772	822	872	922	
K	193	243	293	343	393	443	493	543	593	643	693	743	793	843	893	943	
Mass (kg)	Without brake	2.1	2.2	2.4	2.6	2.8	2.9	3.1	3.3	3.5	3.6	3.8	4.0	4.2	4.3	4.5	4.7
	With brake	2.3	2.4	2.6	2.8	3.0	3.1	3.3	3.5	3.7	3.8	4.0	4.2	4.4	4.5	4.7	4.9

Applicable Controllers

The RCP5 series actuators can be operated by the controllers indicated below. Please select the type depending on your intended use.

Name	External view	Model number	Max. number of controlled axes	Maximum number of positioning points	Input power	Reference page
Positioner type (High-output specification)		PCON-CA-42PWAI-①-2-0	1	512 points	DC24V	→P. 69
Pulse train type (High-output specification)		PCON-CA-42PWAI-PL②-2-0				
Field network type (High-output specification)		PCON-CA-42PWAI-③-0-0				
Solenoid valve multi-axis type (PIO specification)		MSEP-④-⑤-⑥-⑦-2-0	C: 8 (4 when high-output enabled) LC: 6 (3 when high-output enabled)	3 points	Single-phase AC 100V~230V	→P. 77
Positioner multi-axis type (Field network specification)		MSEP-④-⑤-⑥-⑦-0-0				
Program control multi-axis safety category type		MSEL-PG-1-42PWAI-①-2-4	4	30000 points	Single-phase AC 100V~230V	→P. 87
Program control multi-axis safety category type (w/ network board)		MSEL-PG-1-42PWAI-③-0-4				

*Above MSEL models are for single-axis specification

*① I/O type (NP/PN)

*② Number of axes

*③ Field network specification code

*④ C or LC

*⑤ N (NPN specification) or P (PNP specification) code

*The high output enabled operation is only available when the "High-output setting specs" is selected in the MSEP-C/LC.

RCP5-SA7R

RoboCylinder, Slider Type, Side-mounted Motor Type, Actuator Width 73mm, 24V Pulse Motor

Model	RCP5	SA7R	WA	56P				P3		
Specification	Series	Type	Encoder type	Motor type	Lead	Stroke	Applicable controllers	Cable length	Options	
Items			WA: Battery-less absolute specification	56P: Pulse motor, size 56□	24: 24mm 16: 16mm 8: 8mm 4: 4mm	50: 50mm 800: 800mm (Every 50mm)	P3: PCON-CA MSEP MSEL	N: No cable P: 1m S: 3m M: 5m X□: Specified length R□: Robot cable	Please refer to the options table below.	

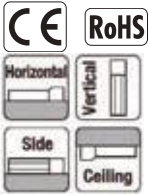

* Depending on the model, there may be some limitations to using the vertical, side, and ceiling mount positions. Please refer to P.59 for details.



The figure above is the motor side-mounted to the left (ML).



- (1) The actuator specification displays the payload's maximum value, but it will vary depending on the acceleration. Please refer to the "Selection Guidelines" (RCP5 Payload by Speed/Acceleration Table) on P. 63.
- (2) Please refer to P. 59 for push-motion operation.

Correlation Diagrams of Speed and Payload

(1) High-output **enabled** with PCON-CA, MSEP, MSEL connected

RCP5-SA7R, Horizontal mount

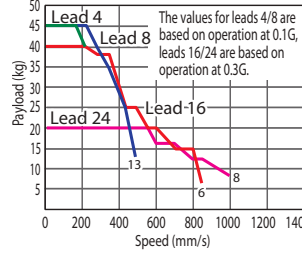

RCP5-SA7R, Vertical mount

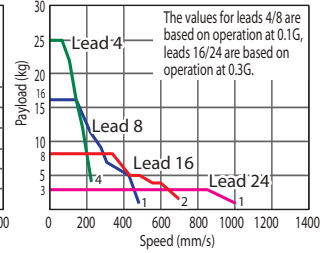

(2) High-output **disabled** with PCON-CA, MSEP connected

RCP5-SA7R, Horizontal mount

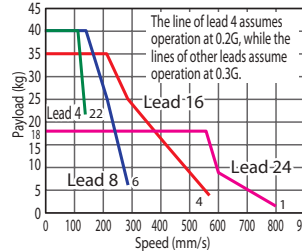

RCP5-SA7R, Vertical mount

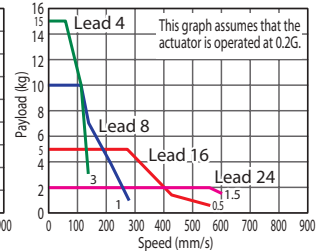

Actuator Specifications

Lead and Payload

Model number	Lead (mm)	Connected controller	Maximum payload		Stroke (mm)
			Horizontal (kg)	Vertical (kg)	
RCP5-SA7R-WA-56P-24-①-P3-②-③	24	High-output enabled	20	3	50~800 (Every 50mm)
		High-output disabled	18	2	
RCP5-SA7R-WA-56P-16-①-P3-②-③	16	High-output enabled	40	8	
		High-output disabled	35	5	
RCP5-SA7R-WA-56P-8-①-P3-②-③	8	High-output enabled	45	16	
		High-output disabled	40	10	
RCP5-SA7R-WA-56P-4-①-P3-②-③	4	High-output enabled	45	25	
		High-output disabled	40	15	

Legend: ① Stroke ② Cable length ③

Stroke and Maximum Speed

Values in brackets <> are for vertical use. (Unit: mm/s)

Lead (mm)	Connected controller	Maximum Speed					
		50~550 (Every 50mm)	600 (mm)	650 (mm)	700 (mm)	750 (mm)	800 (mm)
24	High-output enabled	1000				885	785
	High-output disabled	800 <600>				785	<600>
16	High-output enabled	840 <700>	755 <700>	660	585	520	
	High-output disabled	560				520	
8	High-output enabled	490	430	375	325	290	255
	High-output disabled	280				255	
4	High-output enabled	210	185	160	140	125	
	High-output disabled	140				125	

Cable Length

Type	Cable code
Standard type	P (1m)
	S (3m)
	M (5m)
Special length	X06 (6m) ~X10 (10m)
	X11 (11m) ~X15 (15m)
	X16 (16m) ~X20 (20m)
	R01 (1m) ~R03 (3m)
Robot cable	R04 (4m) ~R05 (5m)
	R06 (6m) ~R10 (10m)
	R11 (11m) ~R15 (15m)
	R16 (16m) ~R20 (20m)

Options

Name	Option code	Reference page
Brake	B	→P. 11
Cable exit direction (Top)	CJT	→P. 11
Cable exit direction (Outside)	CJO	→P. 11
Cable exit direction (Bottom)	CJB	→P. 11
Motor side-mounted to the left (Standard)	ML	→P. 11
Motor side-mounted to the right	MR	→P. 11
Slider roller specification	SR	→P. 11
Slider spacer	SS	→P. 11
Non-motor end specification	NM	→P. 11

Actuator Specifications

Item	Description
Drive system	Ball screw Ø12mm, rolled C10
Positioning repeatability (*1)	±0.02mm [±0.03mm]
Lost motion	0.1mm or less
Base	Material: Aluminum with white alumite treatment
Dynamic allowable moment (*2)	Ma: 11.6N·m, Mb: 16.6N·m, Mc: 33.7N·m
Static allowable moment	Ma: 51.2N·m, Mb: 73.1N·m, Mc: 148N·m
Ambient operating temperature, humidity	0 to 40°C, 85% RH or less (Non-condensing)

(*1) The values in brackets [] are for Lead 24.

(*2) Assumes a standard rated life of 5000km.

• Reference for overhang load lengths / Ma: 230mm or less, Mb, Mc: 230mm or less

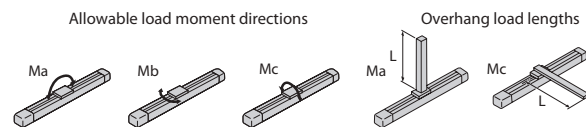

(Note)

The operational life will vary depending on operation and installation conditions. Please refer to the RC General Catalog for details on operational life, allowable moment direction, and overhang load length.

Dimensions

CAD drawings can be downloaded from the website.

www.robocylinder.de

2/3D CAD

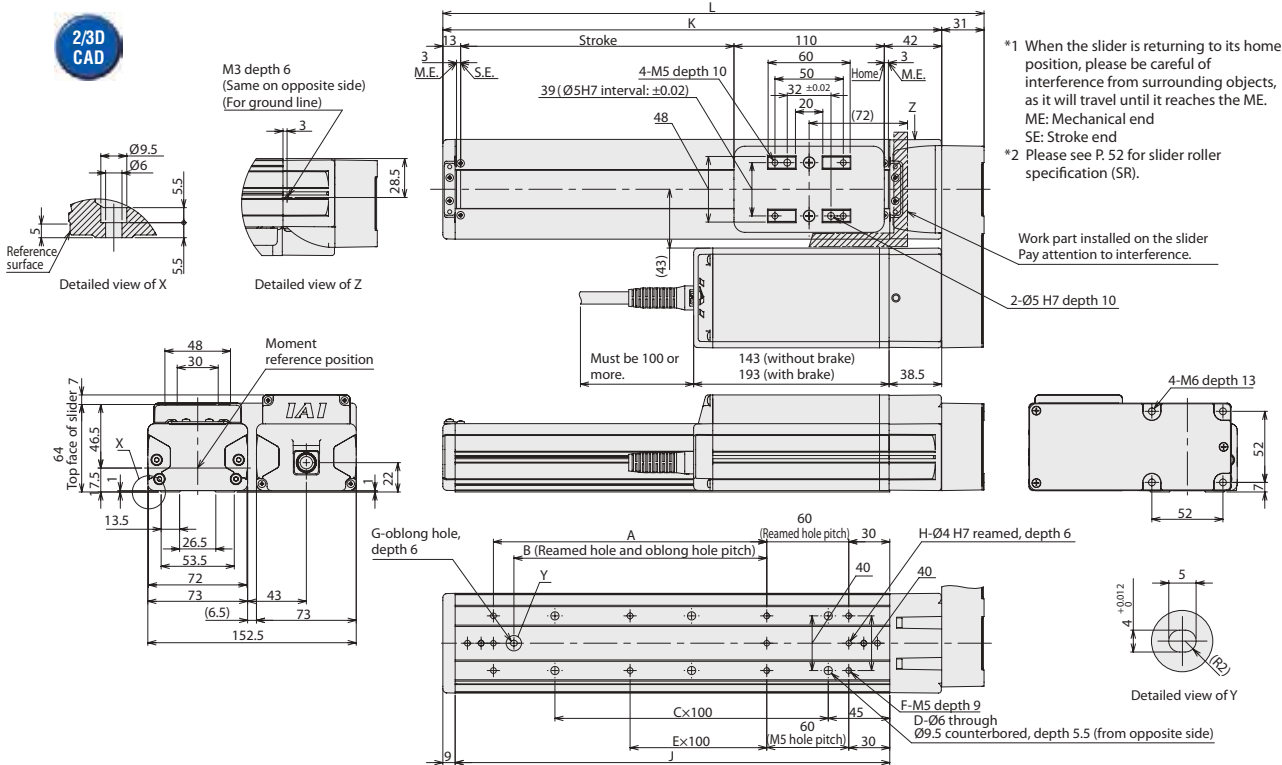

■ Cable Exit Direction (Option)

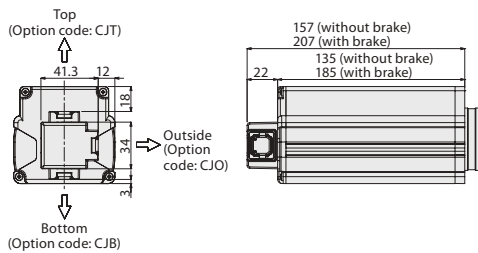

*The figure above is for the motor side-mounted to the left (ML).

■ Slider Spacer (Option)

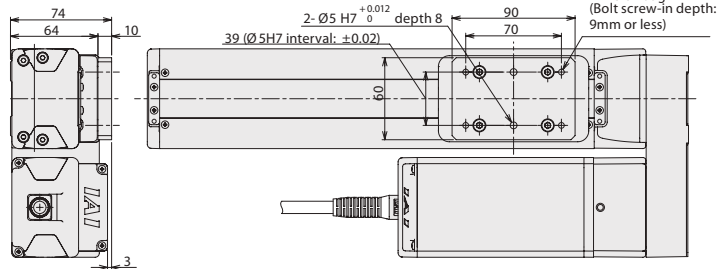

■ Dimensions and Mass by Stroke

Stroke	50	100	150	200	250	300	350	400	450	500	550	600	650	700	750	800	
L	246	296	346	396	446	496	546	596	646	696	746	796	846	896	946	996	
A	0	100	100	200	200	300	300	400	400	500	500	600	600	700	700	800	
B	0	85	85	185	185	285	285	385	385	485	485	585	585	685	685	785	
C	1	1	2	2	3	3	4	4	5	5	6	6	7	7	8	8	
D	4	4	6	6	8	8	10	10	12	12	14	14	16	16	18	18	
E	0	0	0	1	1	2	2	3	3	4	4	5	5	6	6	7	
F	4	6	6	8	8	10	10	12	12	14	14	16	16	18	18	20	
G	0	1	1	1	1	1	1	1	1	1	1	1	1	1	1	1	
H	2	3	3	3	3	3	3	3	3	3	3	3	3	3	3	3	
J	168	218	268	318	368	418	468	518	568	618	668	718	768	818	868	918	
K	215	265	315	365	415	465	515	565	615	665	715	765	815	865	915	965	
Mass (kg)	Without brake	3.7	3.9	4.2	4.4	4.6	4.8	5.1	5.3	5.5	5.7	6.0	6.2	6.4	6.6	6.8	7.1
	With brake	4.2	4.4	4.7	4.9	5.1	5.3	5.6	5.8	6.0	6.2	6.5	6.7	6.9	7.1	7.3	7.6

Applicable Controllers

The RCP5 series actuators can be operated by the controllers indicated below. Please select the type depending on your intended use.

Name	External view	Model number	Max. number of controlled axes	Maximum number of positioning points	Input power	Reference page
Positioner type (High-output specification)		PCON-CA-56PWAI-①-2-0	1	512 points	DC24V	→P. 69
Pulse train type (High-output specification)		PCON-CA-56PWAI-PL②-2-0		768 points		
Field network type (High-output specification)		PCON-CA-56PWAI-③-0-0		3 points		
Solenoid valve multi-axis type (PIO specification)		MSEP-④-①-①-①-①-2-0	C: 8 (4 when high-output enabled) L: 6 (3 when high-output enabled)	3 points	Single-phase AC 100V~230V	→P. 77
Positioner multi-axis type (Field network specification)		MSEP-④-①-①-①-①-0-0		256 points		
Program control multi-axis safety category type		MSEL-PG-1-56PWAI-①-2-4	4	30000 points	Single-phase AC 100V~230V	→P. 87
Program control multi-axis safety category type (w/ network board)		MSEL-PG-1-56PWAI-③-0-4				

*Above MSEL models are for single-axis specification

*① I/O type (NP/PN)

*③ Number of axes

*④ Field network specification code

*④ C or LC

*④ N (NPN specification) or P (PNP specification) code

*The high output enabled operation is only available when the "High-output setting specs" is selected in the MSEP-C/LC.

RCP5-RA4C

RoboCylinder, Rod Type, Motor Unit Coupled, Actuator Width 40mm, 24V Pulse Motor

Model	RCP5	RA4C	WA	35P			P3		
Specification	Series	Type	Encoder type	Motor type	Lead	Stroke	Applicable controllers	Cable length	Options
Items			WA: Battery-less absolute specification	35P: Pulse motor, size 35□	16: 16mm 10: 10mm 5: 5mm 2.5: 2.5mm	60: 60mm 410: 410mm (Every 50mm)	P3: PCON-CA MSEP MSEL	N: No cable P: 1m S: 3m M: 5m X□: Specified length R□: Robot cable	Please refer to the options table below.

Radial Load Applicable



* Depending on the model, there may be some limitations to using the vertical mount position. Please refer to P.59 for details.



- POINT**
Note on selection
- (1) The actuator specification displays the payload's maximum value, but it will vary depending on the acceleration. Please refer to the "Selection Guidelines" (RCP5 Payload by Speed/Acceleration Table) on P. 61.
 - (2) Please refer to P. 59 for push-motion operation.
 - (3) The radial cylinder is equipped with a built-in guide. Please refer to the graphs shown in P. 65 and after for the allowable load mass.

Correlation Diagrams of Speed and Payload

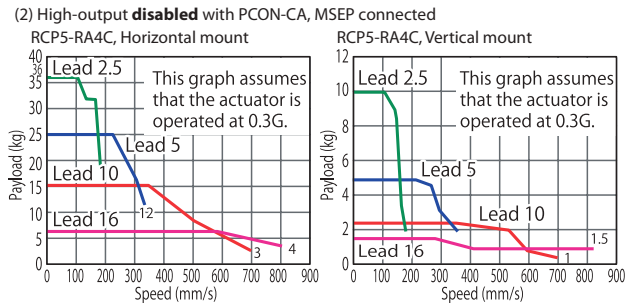
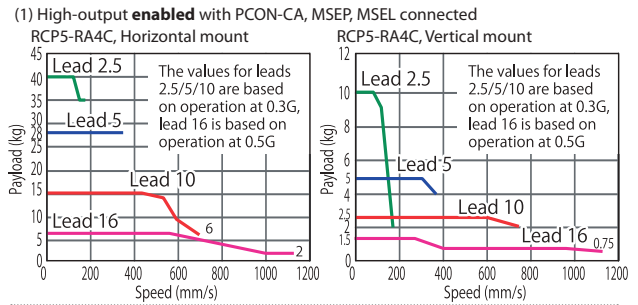

Actuator Specifications

Lead and Payload

Model number	Lead (mm)	Connected controller	Maximum payload		Maximum push force (N)	Stroke (mm)
			Horizontal (kg)	Vertical (kg)		
RCP5-RA4C-WA-35P-16-①-P3-②-③	16	High-output enabled	5	1	48	60~410 (Every 50mm)
		High-output disabled				
RCP5-RA4C-WA-35P-10-①-P3-②-③	10	High-output enabled	12	2.5	77	
		High-output disabled	10	2		
RCP5-RA4C-WA-35P-5-①-P3-②-③	5	High-output enabled	25	5	155	
		High-output disabled	22			
RCP5-RA4C-WA-35P-2.5-①-P3-②-③	2.5	High-output enabled	40	10	310	
		High-output disabled	35			

Legend: ① Stroke ② Cable length ③ Options

Stroke and Maximum Speed

Lead (mm)	Connected controller	60~360 (Every 50mm)		410 (mm)
		60~360 (Every 50mm)	410 (mm)	
16	High-output enabled	1120	1080	
	High-output disabled	840		
10	High-output enabled	700	685	
	High-output disabled			
5	High-output enabled	350	340	
	High-output disabled			
2.5	High-output enabled	175	170	
	High-output disabled			

Cable Length

Type	Cable code		
	P (1m)	S (3m)	M (5m)
Standard type			
Special length	X06 (6m) ~ X10 (10m)		
	X11 (11m) ~ X15 (15m)		
	X16 (16m) ~ X20 (20m)		
Robot cable	R01 (1m) ~ R03 (3m)		
	R04 (4m) ~ R05 (5m)		
	R06 (6m) ~ R10 (10m)		
	R11 (11m) ~ R15 (15m)		
	R16 (16m) ~ R20 (20m)		

Options

Name	Option code	Reference page
Brake	B	→P. 11
Cable exit direction (Top)	CJT	→P. 11
Cable exit direction (Right)	CJR	→P. 11
Cable exit direction (Left)	CJL	→P. 11
Cable exit direction (Bottom)	CJB	→P. 11
Flange	FL	→P. 12
Tip adapter (Flange)	FFA	→P. 12
Tip adapter (Internal thread)	NFA	→P. 13
Tip adapter (Keyway)	KFA	→P. 13
Non-motor end specification	NM	→P. 11

Actuator Specifications

Item	Description
Drive system	Ball screw Ø8mm, rolled C10
Positioning repeatability	±0.02mm
Lost motion	0.1mm or less
Rod	Ø20mm Aluminum
Rod non-rotation precision (*1)	±0 deg
Allowable load and torque on rod tip	Refer to table in the page on the right, refer to P. 65
Rod tip overhang distance	100mm or less
Ambient operating temperature, humidity	0 to 40°C, 85% RH or less (Non-condensing)

(*1) Rod's angular displacement in rotational direction with no applied load is shown.

Offset distance at end of rod (100mm or less)

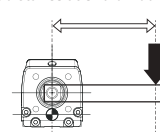

Load at end of rod

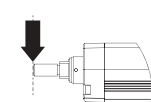

Dimensions

CAD drawings can be downloaded from the website.

www.robocylinder.de

2/3D
CAD

- *1 When the rod is returning to its home position, please be careful of interference from surrounding objects, as it will travel until it reaches the ME.
 - *2 The direction of width across flats varies depending on the product.
 - *3 If the actuator is installed using the front housing and flange, make sure the actuator will not receive any external force.
- ME: Mechanical end
SE: Stroke end

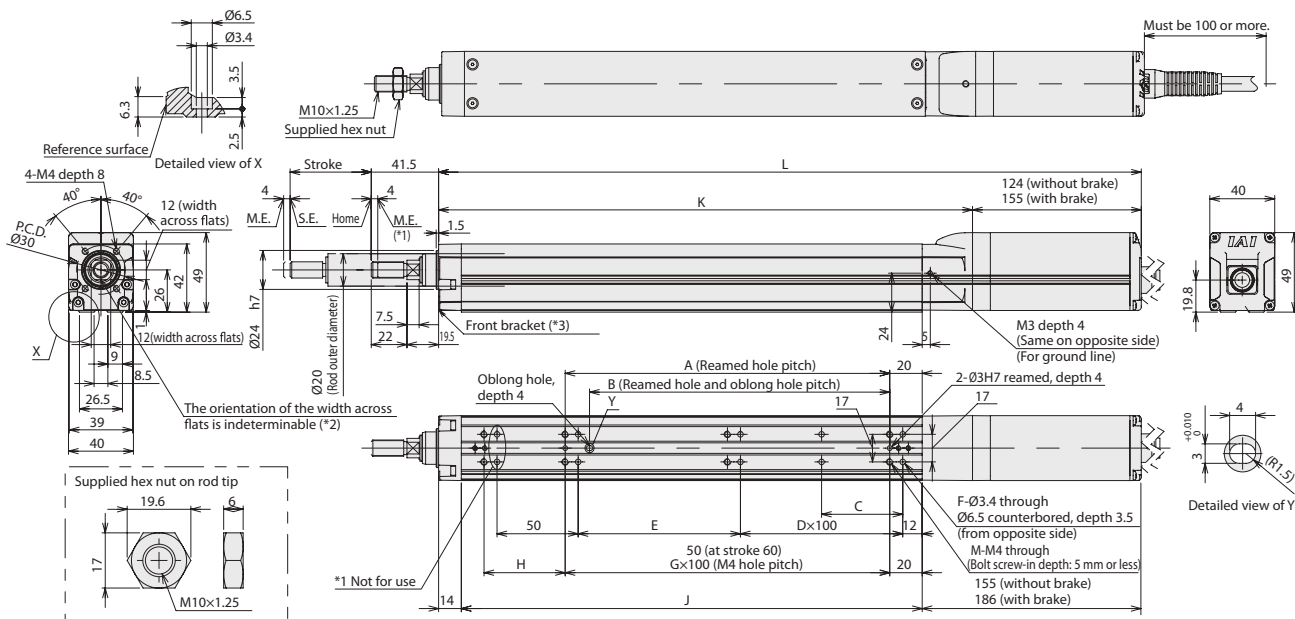

*1 Two mounting holes on the rod side of the top of the base cannot be used.

Cable Exit Direction (Option)

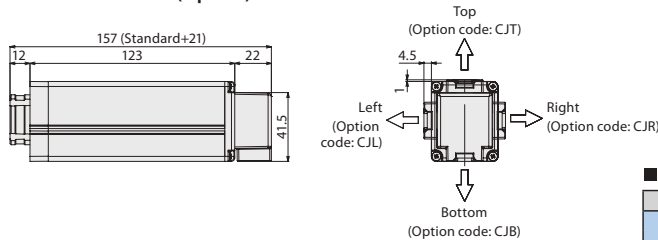

Dimensions and Mass by Stroke

Stroke	Stroke								
	60	110	160	210	260	310	360	410	
L	Without brake	303	353	403	453	503	553	603	653
	With brake	334	384	434	484	534	584	634	684
A	50	100	100	200	200	300	300	400	400
B	35	85	85	185	185	285	285	385	385
C	25	50	50	50	50	50	50	50	50
D	0	0	1	1	2	2	3	3	3
E	50	100	50	100	50	100	50	100	100
F	8	8	10	10	12	12	14	14	14
G	-	1	1	2	2	3	3	4	4
H	50	50	100	50	100	50	100	50	50
J	134	184	234	284	334	384	434	484	484
K	179	229	279	329	379	429	479	529	529
M	6	6	6	8	8	10	10	12	12
Allowable static load on rod tip (N)	Without brake	55.8	44.6	37.1	31.7	27.6	24.3	21.7	19.5
	With brake	25.4	19.5	15.5	12.8	10.8	9.2	7.9	6.9
Allowable dynamic load on rod tip (N)	Load offset 0mm	16.5	14.5	12.4	10.7	9.2	8.0	7.0	6.2
	Load offset 100mm	5.6	4.5	3.8	3.2	2.8	2.5	2.3	2.1
Allowable static torque on rod tip (N-m)	Without brake	1.7	1.5	1.2	1.1	0.9	0.8	0.7	0.6
	With brake	1.7	1.5	1.2	1.1	0.9	0.8	0.7	0.6
Mass (kg)	Without brake	1.1	1.2	1.3	1.4	1.6	1.7	1.8	1.9
	With brake	1.3	1.4	1.5	1.6	1.8	1.9	2.0	2.1

Rod Deflection of RCP5-RA4C (Reference Values)

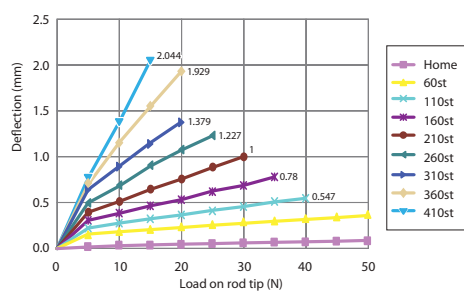

Applicable Controllers

The RCP5 series actuators can be operated by the controllers indicated below. Please select the type depending on your intended use.

Name	External view	Model number	Max. number of controlled axes	Maximum number of positioning points	Input power	Reference page
Positioner type (High-output specification)		PCON-CA-35PWAI-①-2-0	1	512 points	DC24V	→P. 69
Pulse train type (High-output specification)		PCON-CA-35PWAI-PL②-2-0				
Field network type (High-output specification)		PCON-CA-35PWAI-③-0-0				
Solenoid valve multi-axis type (PIO specification)		MSEP-④-⑤---①-2-0	C: 8 (4 when high-output enabled) LC: 6 (3 when high-output enabled)	3 points	Single-phase AC 100V~230V	→P. 77
Positioner multi-axis type (Field network specification)		MSEP-④-①---③-0-0				
Program control multi-axis safety category type		MSEL-PG-1-35PWAI-①-2-4	4	30000 points	Single-phase AC 100V~230V	→P. 87
Program control multi-axis safety category type (w/ network board)		MSEL-PG-1-35PWAI-③-0-4				

*Above MSEL models are for single-axis specification

*① I/O type (NP/PN)

*③ Number of axes

*④ Field network specification code

*⑤ C or LC

*④ N (NPN specification) or P (PNP specification) code

*The high output enabled operation is only available when the "High-output setting specs" is selected in the MSEP-C/LC.

RCP5-RA6C

RoboCylinder, Rod Type, Motor Unit Coupled, Actuator Width 58mm, 24V Pulse Motor

Model	RCP5	RA6C	WA	42P			P3		
Specification	Series	Type	Encoder type	Motor type	Lead	Stroke	Applicable controllers	Cable length	Options
Items			WA: Battery-less absolute specification	42P: Pulse motor, size 42□	20: 20mm 12: 12mm 6: 6mm 3: 3mm	65: 65mm 415: 415mm (Every 50mm)	P3: PCON-CA MSEP MSEL	N: No cable P: 1m S: 3m M: 5m X□: Specified length R□: Robot cable	Please refer to the options table below.

Radial Load Applicable



* Depending on the model, there may be some limitations to using the vertical mount position. Please refer to P.59 for details.



- (1) The actuator specification displays the payload's maximum value, but it will vary depending on the acceleration. Please refer to the "Selection Guidelines" (RCP5 Payload by Speed/Acceleration Table) on P. 61.
- (2) Please refer to P. 59 for push-motion operation.
- (3) The radial cylinder is equipped with a built-in guide. Please refer to the graphs shown in P. 65 and after for the allowable load mass.

Correlation Diagrams of Speed and Payload

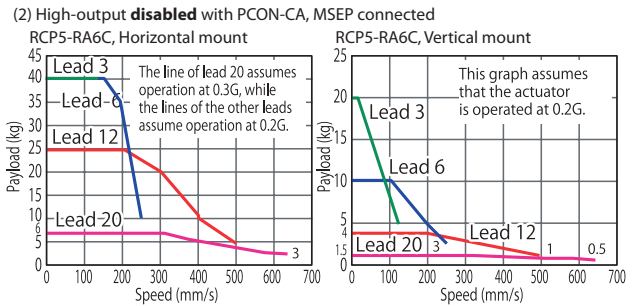
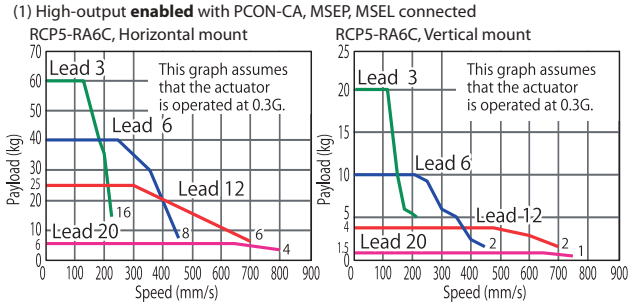

Actuator Specifications

Lead and Payload

Model number	Lead (mm)	Connected controller	Maximum payload		Stroke (mm)
			Horizontal (kg)	Vertical (kg)	
RCP5-RA6C-WA-42P-20-①-P3-②-③	20	High-output enabled	6	1.5	65~415 (Every 50mm)
		High-output disabled			
RCP5-RA6C-WA-42P-12-①-P3-②-③	12	High-output enabled	25	4	65~415 (Every 50mm)
		High-output disabled			
RCP5-RA6C-WA-42P-6-①-P3-②-③	6	High-output enabled	40	10	65~415 (Every 50mm)
		High-output disabled			
RCP5-RA6C-WA-42P-3-①-P3-②-③	3	High-output enabled	60	20	65~415 (Every 50mm)
		High-output disabled	40		

Legend: ① Stroke ② Cable length ③ Options

Stroke and Maximum Speed

(Unit: mm/s)

Lead (mm)	Connected controller	Maximum speed	
		65~365 (Every 50mm)	415 (mm)
20	High-output enabled	800	
	High-output disabled	640	
12	High-output enabled	700	
	High-output disabled	500	
6	High-output enabled	450	
	High-output disabled	250	
3	High-output enabled	225	220
	High-output disabled	125	

Cable Length

Type	Cable code		
	P (1m)	S (3m)	M (5m)
Standard type			
Special length			
Robot cable			

Options

Name	Option code	Reference page
Brake	B	→P. 11
Cable exit direction (Top)	CJT	→P. 11
Cable exit direction (Right)	CJR	→P. 11
Cable exit direction (Left)	CJL	→P. 11
Cable exit direction (Bottom)	CJB	→P. 11
Flange	FL	→P. 12
Tip adapter (Flange)	FFA	→P. 12
Tip adapter (Internal thread)	NFA	→P. 13
Tip adapter (Keyway)	KFA	→P. 13
Non-motor end specification	NM	→P. 11

Actuator Specifications

Item	Description
Drive system	Ball screw Ø10mm, rolled C10
Positioning repeatability (*1)	±0.02mm (±0.03mm)
Lost motion	0.1mm or less
Rod	Ø25mm Aluminum
Rod non-rotation precision (*2)	±0 deg
Allowable load and torque on rod tip	Refer to table in the page on the right, refer to P. 65
Rod tip overhang distance	100mm or less
Ambient operating temperature, humidity	0 to 40°C, 85% RH or less (Non-condensing)

(*1) The values in brackets [] are for Lead 20.

(*2) Rod's angular displacement in rotational direction with no applied load is shown.

Offset distance at end of rod (100mm or less)

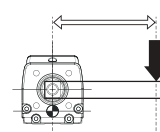

Load at end of rod

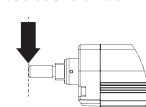

Dimensions

CAD drawings can be downloaded from the website.

www.robocylinder.de

2/3D
CAD

- *1 When the rod is returning to its home position, please be careful of interference from surrounding objects, as it will travel until it reaches the ME.
- *2 The direction of width across flats varies depending on the product.
- *3 If the actuator is installed using the front housing and flange, make sure the actuator will not receive any external force.

ME: Mechanical end

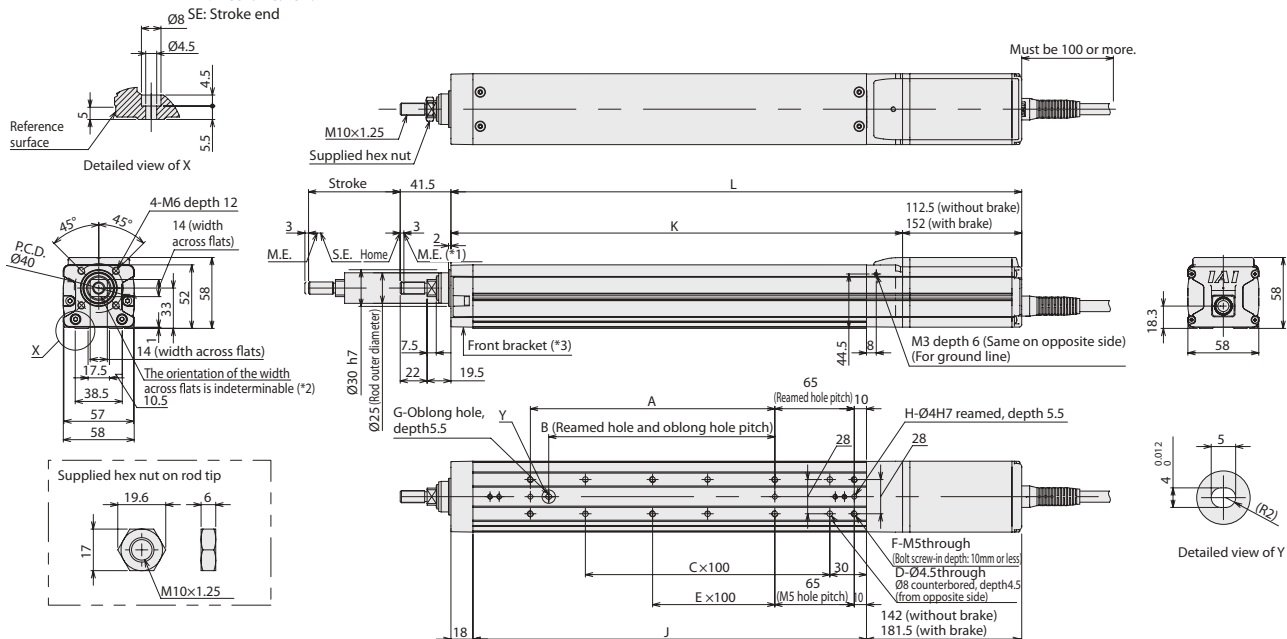

■ Cable Exit Direction (Option)

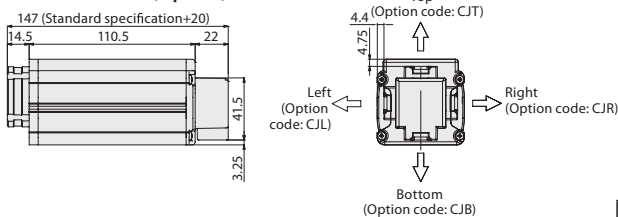

■ Rod Deflection of RCP5-RA6C (Reference Values)

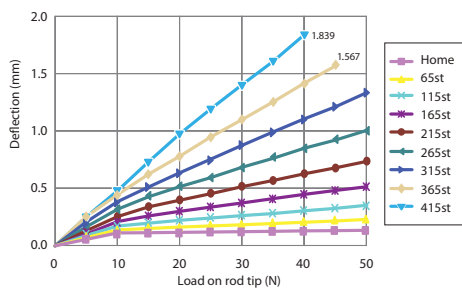

■ Dimensions and Mass by Stroke

Stroke	65	115	165	215	265	315	365	415	
									L
L	With brake	371.5	421.5	471.5	521.5	571.5	621.5	671.5	721.5
A	0	100	100	200	200	300	300	400	
B	0	85	85	185	185	285	285	385	
C	1	1	2	2	3	3	4	4	
D	4	4	6	6	8	8	10	10	
E	0	0	0	1	1	2	2	3	
F	4	6	6	8	8	10	10	12	
G	0	1	1	1	1	1	1	1	
H	2	3	3	3	3	3	3	3	
J	172	222	272	322	372	422	472	522	
K	219.5	269.5	319.5	369.5	419.5	469.5	519.5	569.5	
Allowable static load on rod tip (N)	113.8	92.6	78.0	67.3	59.0	52.5	47.2	42.8	
Allowable dynamic load on rod tip (N)	Load offset 0mm	45.7	36.3	29.8	25.1	21.6	18.8	16.6	14.7
	Load offset 100mm	32.1	28.3	24.6	21.5	18.9	16.7	14.9	13.4
Allowable static torque on rod tip (N·m)	11.5	9.4	7.9	6.8	6.0	5.4	4.9	4.5	
Allowable dynamic torque on rod tip (N·m)	3.2	2.8	2.5	2.1	1.9	1.7	1.5	1.3	
Mass (kg)	Without brake	1.8	2.0	2.2	2.4	2.6	2.9	3.1	3.3
	With brake	2.0	2.2	2.4	2.6	2.8	3.1	3.3	3.5

Applicable Controllers

The RCP5 series actuators can be operated by the controllers indicated below. Please select the type depending on your intended use.

Name	External view	Model number	Max. number of controlled axes	Maximum number of positioning points	Input power	Reference page
Positioner type (High-output specification)		PCON-CA-42PWAI-①-2-0	1	512 points	DC24V	→P. 69
Pulse train type (High-output specification)		PCON-CA-42PWAI-PL②-2-0				
Field network type (High-output specification)		PCON-CA-42PWAI-③-0-0				
Solenoid valve multi-axis type (PIO specification)		MSEP-④-⑤-⑥-⑦-2-0	C: 8 (4 when high-output enabled) LC: 6 (3 when high-output enabled)	3 points		→P. 77
Positioner multi-axis type (Field network specification)		MSEP-④-⑤-⑥-⑦-0-0				
Program control multi-axis safety category type		MSEL-PG-1-42PWAI-①-2-4	4	30000 points	Single-phase AC 100V~230V	→P. 87
Program control multi-axis safety category type (w/ network board)		MSEL-PG-1-42PWAI-③-0-4				

*Above MSEL models are for single-axis specification

*① I/O type (NP/PN)

*③ Number of axes

*② Field network specification code

*④ C or LC

*⑤ N (NPN specification) or P (PNP specification) code

*The high output enabled operation is only available when the "High-output setting specs" is selected in the MSEP-C/LC.

RCP5-RA7C

RoboCylinder, Rod Type, Motor Unit Coupled, Actuator Width 73mm, 24V Pulse Motor

Model	RCP5	RA7C	WA	56P			P3		
Specification	Series	Type	Encoder type	Motor type	Lead	Stroke	Applicable controllers	Cable length	Options
Items			WA: Battery-less absolute specification	56P: Pulse motor, size 56□	24: 24mm 16: 16mm 8: 8mm 4: 4mm	70: 70mm 520: 520mm (Every 50mm)	P3: PCON-CA MSEP MSEL	N: No cable P: 1m S: 3m M: 5m X□: Specified length R□: Robot cable	Please refer to the options table below.

Radial Load Applicable

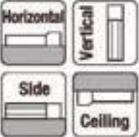

* Depending on the model, there may be some limitations to using the vertical mount position. Please refer to P.59 for details.



- (1) The actuator specification displays the payload's maximum value, but it will vary depending on the acceleration. Please refer to the "Selection Guidelines" (RCP5 Payload by Speed/Acceleration Table) on P. 61.
- (2) Please refer to P. 59 for push-motion operation.
- (3) The radial cylinder is equipped with a built-in guide. Please refer to the graphs shown in P. 65 and after for the allowable load mass.

Correlation Diagrams of Speed and Payload

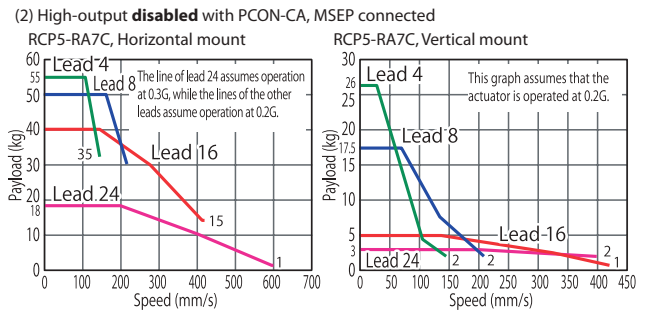
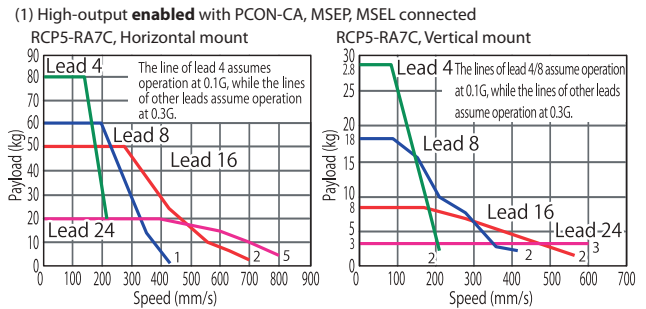

Actuator Specifications

Lead and Payload

Model number	Lead (mm)	Connected controller	Maximum payload		Maximum push force (N)	Stroke (mm)
			Horizontal (kg)	Vertical (kg)		
RCP5-RA7C-WA-56P-24-①-P3-②-③	24	High-output enabled	20	3	182	70~520 (Every 50mm)
		High-output disabled	18	3		
RCP5-RA7C-WA-56P-16-①-P3-②-③	16	High-output enabled	50	8	273	
		High-output disabled	40	5		
RCP5-RA7C-WA-56P-8-①-P3-②-③	8	High-output enabled	60	18	547	
		High-output disabled	50	17.5		
RCP5-RA7C-WA-56P-4-①-P3-②-③	4	High-output enabled	80	28	1094	
		High-output disabled	55	26		

Legend: ① Stroke ② Cable length ③ Options

Stroke and Maximum Speed

Values in brackets <> are for vertical use. (Unit: mm/s)

Lead (mm)	Connected controller	70~520 (Every 50mm)
24	High-output enabled	800 <600>
	High-output disabled	600 <400>
16	High-output enabled	700 <560>
	High-output disabled	420
8	High-output enabled	420
	High-output disabled	210
4	High-output enabled	210
	High-output disabled	140

Cable Length

Type	Cable code
Standard type	P (1m) S (3m) M (5m)
Special length	X06 (6m) ~X10 (10m)
	X11 (11m) ~X15 (15m)
	X16 (16m) ~X20 (20m)
Robot cable	R01 (1m) ~R03 (3m)
	R04 (4m) ~R05 (5m)
	R06 (6m) ~R10 (10m)
	R11 (11m) ~R15 (15m)
	R16 (16m) ~R20 (20m)

Options

Name	Option code	Reference page
Brake	B	→P. 11
Cable exit direction (Top)	CJT	→P. 11
Cable exit direction (Right)	CJR	→P. 11
Cable exit direction (Left)	CJL	→P. 11
Cable exit direction (Bottom)	CJB	→P. 11
Flange	FL	→P. 12
Tip adapter (Flange)	FFA	→P. 12
Tip adapter (Internal thread)	NFA	→P. 13
Tip adapter (Keyway)	KFA	→P. 13
Non-motor end specification	NM	→P. 11

Actuator Specifications

Item	Description
Drive system	Ball screw Ø12mm, rolled C10
Positioning repeatability (*1)	±0.02mm [±0.03mm]
Lost motion	0.1mm or less
Rod	Ø30mm Aluminum
Rod non-rotation precision (*2)	±0 deg
Allowable load and torque on rod tip	Refer to table in the page on the right, refer to P. 65
Rod tip overhang distance	100mm or less
Ambient operating temperature, humidity	0 to 40°C, 85% RH or less (Non-condensing)

(*1) The values in brackets [] are for Lead 24.

(*2) Rod's angular displacement in rotational direction with no applied load is shown.

Offset distance at end of rod (100mm or less)

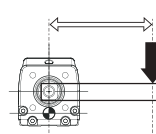

Load at end of rod

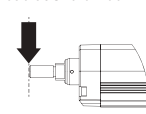

Dimensions

CAD drawings can be downloaded from the website.

www.robocylinder.de

2/3D
CAD

- *1 When the rod is returning to its home position, please be careful of interference from surrounding objects, as it will travel until it reaches the ME.
- *2 The direction of width across flats varies depending on the product.
- *3 If the actuator is installed using the front housing and flange, make sure the actuator will not receive any external force.

ME: Mechanical end
SE: Stroke end

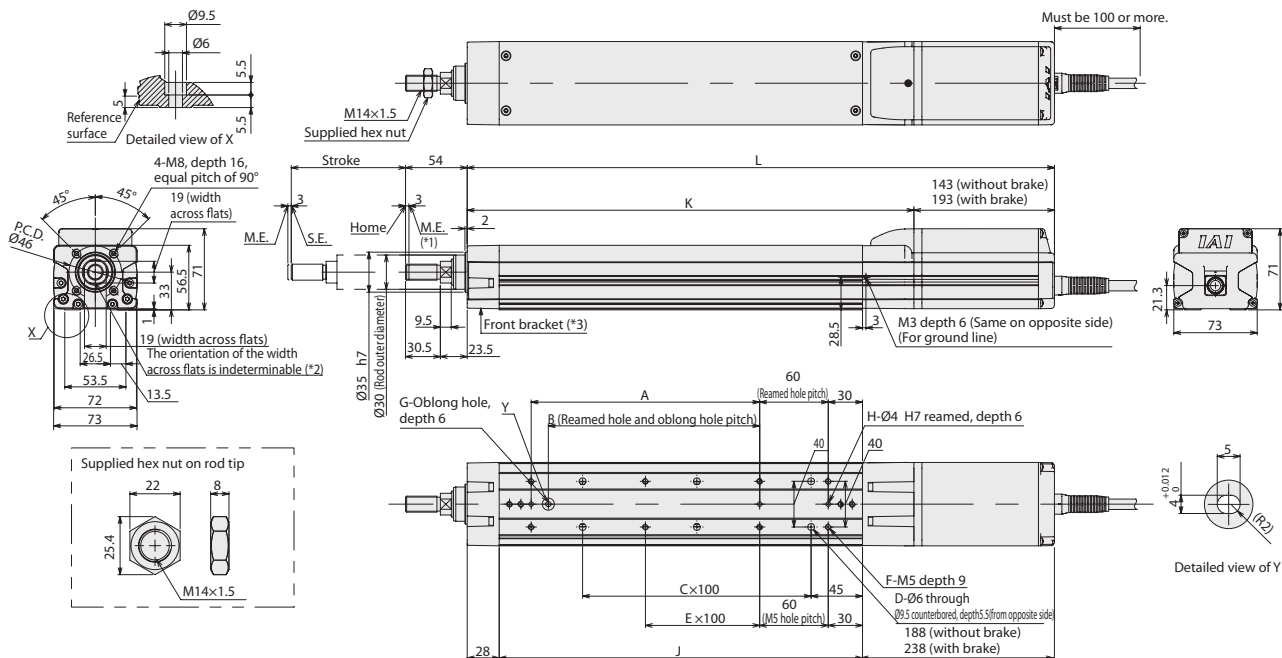

■ Cable Exit Direction (Option)

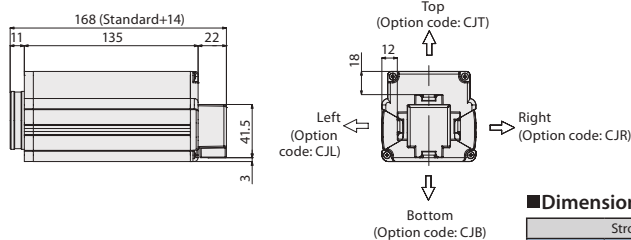

■ Rod Deflection of RCP5-RA7C (Reference Values)

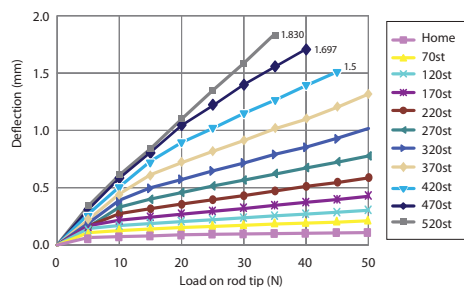

■ Dimensions and Mass by Stroke

Stroke	70	120	170	220	270	320	370	420	470	520	
L	Without brake	384	434	484	534	584	634	684	734	784	834
	With brake	434	484	534	584	634	684	734	784	834	884
A	0	100	100	200	200	300	300	400	400	500	
B	0	85	85	185	185	285	285	385	385	485	
C	1	1	2	2	3	3	4	4	5	5	
D	4	4	6	6	8	8	10	10	12	12	
E	0	0	0	1	1	2	2	3	3	4	
F	4	6	6	8	8	10	10	12	12	14	
G	0	1	1	1	1	1	1	1	1	1	
H	2	3	3	3	3	3	3	3	3	3	
J	168	218	268	318	368	418	468	518	568	618	
K	241	291	341	391	441	491	541	591	641	691	
Allowable static load on rod tip (N)	119.2	97.7	82.8	71.6	63.0	56.2	50.6	46.0	42.2	38.8	
Allowable dynamic load on rod tip (N)	44.3	35.7	29.6	25.2	21.7	19.0	16.8	15.0	13.6	12.2	
Allowable static torque on rod tip (N-m)	33.9	29.7	25.7	22.4	19.7	17.4	15.5	14.0	12.8	11.5	
Allowable dynamic torque on rod tip (N-m)	12.1	10.0	8.5	7.4	6.5	5.9	5.3	4.9	4.5	4.1	
Mass (kg)	Without brake	3.3	3.6	3.9	4.2	4.5	4.8	5.1	5.4	5.6	5.9
	With brake	3.8	4.1	4.4	4.7	5.0	5.3	5.6	5.9	6.1	6.4

Applicable Controllers

The RCP5 series actuators can be operated by the controllers indicated below. Please select the type depending on your intended use.

Name	External view	Model number	Max. number of controlled axes	Maximum number of positioning points	Input power	Reference page
Positioner type (High-output specification)		PCON-CA-56PWAI-①-2-0	1	512 points	DC24V	→P. 69
Pulse train type (High-output specification)		PCON-CA-56PWAI-PL②-2-0				
Field network type (High-output specification)		PCON-CA-56PWAI-③-0-0				
Solenoid valve multi-axis type (PIO specification)		MSEP-④-⑤-⑥-⑦-⑧-2-0	C: 8 (4 when high-output enabled) LC: 6 (3 when high-output enabled)	3 points		→P. 77
Positioner multi-axis type (Field network specification)		MSEP-④-⑤-⑥-⑦-⑧-0-0				
Program control multi-axis safety category type		MSEL-PG-1-56PWAI-①-2-4	4	30000 points	Single-phase AC 100V~230V	→P. 87
Program control multi-axis safety category type (w/ network board)		MSEL-PG-1-56PWAI-③-0-4				

*Above MSEL models are for single-axis specification

*① I/O type (NP/PN)

*② Number of axes

*③ Field network specification code

*④ C or LC

*⑤ N (NPN specification) or P (PNP specification) code

*The high output enabled operation is only available when the "High-output setting specs" is selected in the MSEP-C/LC.

RCP5-RA8C

RoboCylinder, High-thrust Rod Type, Motor Unit Coupled, Actuator Width 88mm, 24V Pulse Motor

Model	RCP5	RA8C	WA	60P			P4		
Specification	Series	Type	Encoder type	Motor type	Lead	Stroke	Applicable controller	Cable length	Options
Items			WA: Battery-less absolute specification	60P: Pulse motor, size 60□	20: 20mm 10: 10mm 5: 5mm	50: 50mm 700: 700mm (Every 50mm)	P4: PCON-CFA	N: No cable P: 1m S: 3m M: 5m X□□: Specified length R□□: Robot cable	Please refer to the options table below.

Radial Load Applicable

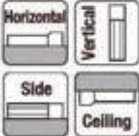

* Depending on the model, there may be some limitations to using the vertical mount position. Please refer to P.59 for details.



- POINT**
Note on selection
- (1) The payload assumes operation at an acceleration of 0.1G for lead 5 and operation at an acceleration of 0.2G for lead 10 and lead 20. The above values are the upper limits of acceleration/deceleration.
 - (2) Please note that the RA8C requires a dedicated controller (high-thrust PCON-CFA).
 - (3) The radial cylinder is equipped with a built-in guide.

Correlation Diagrams of Speed and Payload

RCP5-RA8C, Horizontal mount, PCON-CFA connected

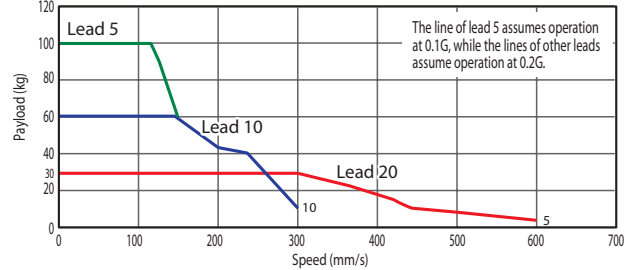

RCP5-RA8C, Vertical mount, PCON-CFA connected

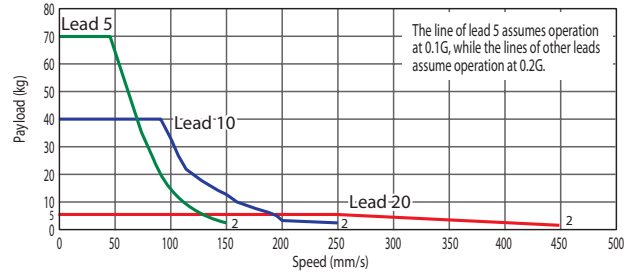

Actuator Specifications

Lead and Payload

Model number	Lead (mm)	Connected controller	Maximum payload		Maximum push force (N)	Stroke (mm)
			Horizontal (kg)	Vertical (kg)		
RCP5-RA8C-WA-60P-20-①-P4-②-③	20	PCON-CFA	30	5	500	50~700 (Every 50mm)
RCP5-RA8C-WA-60P-10-①-P4-②-③	10	PCON-CFA	60	40	1,000	
RCP5-RA8C-WA-60P-5-①-P4-②-③	5	PCON-CFA	100	70	2,000	

Legend: ① Stroke ② Cable length ③ Options

Stroke and Maximum Speed

Values in brackets <> are for vertical use. (Unit: mm/s)

Lead (mm)	50 (mm)	100 (mm)	150 (mm)	200 (mm)	250~350 (mm)	400 (mm)	450 (mm)	500 (mm)	550 (mm)	600 (mm)	650 (mm)	700 (mm)
20	280	405	505 <450>	585 <450>	600 <450>	520 <450>	440	360	320	280	240	220
10	280 <250>		300 <250>			260 <250>	220	180	160	140	120	110
5			150			130	110	90	80	70	60	55

Cable Length

Type	Cable code		
Standard type	P (1m)	S (3m)	M (5m)
Special length	X06 (6m) ~X10 (10m)		
	X11 (11m) ~X15 (15m)		
	X16 (16m) ~X20 (20m)		
Robot cable	R01 (1m) ~R03 (3m)		
	R04 (4m) ~R05 (5m)		
	R06 (6m) ~R10 (10m)		
	R11 (11m) ~R15 (15m)		
	R16 (16m) ~R20 (20m)		

Options

Name	Option code	Reference page
Brake	B	→P. 11
Cable exit direction (Top)	CJT	→P. 11
Cable exit direction (Right)	CJR	→P. 11
Cable exit direction (Left)	CJL	→P. 11
Cable exit direction (Bottom)	CJB	→P. 11
Flange	FL	→P. 12
Non-motor end specification	NM	→P. 11

Actuator Specifications

Item	Description
Drive system	Ball screw Ø16mm, rolled C10
Positioning repeatability	±0.02mm
Lost motion	0.1mm or less
Rod	Ø40mm Aluminum
Rod non-rotation precision (*1)	±0 deg
Allowable load and torque on rod tip	Refer to table in the page on the right, refer to P. 65
Rod tip overhang distance	100mm or less
Ambient operating temperature, humidity	0 to 40°C, 85% RH or less (Non-condensing)

(*1) Rod's angular displacement in rotational direction with no applied load is shown.

Offset distance at end of rod (100mm or less)

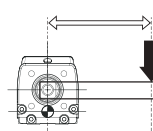

Load at end of rod

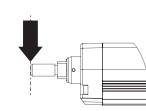

CAD drawings can be downloaded from the website.

www.robocylinder.de



- *1 When the rod is returning to its home position, please be careful of interference from surrounding objects, as it will travel until it reaches the ME.
 - *2 The direction of width across flats varies depending on the product.
 - *3 If the actuator is installed using the front housing and flange, make sure the actuator will not receive any external force.
- ME: Mechanical end
SE: Stroke end

■ Dimensions with Flange (Option)

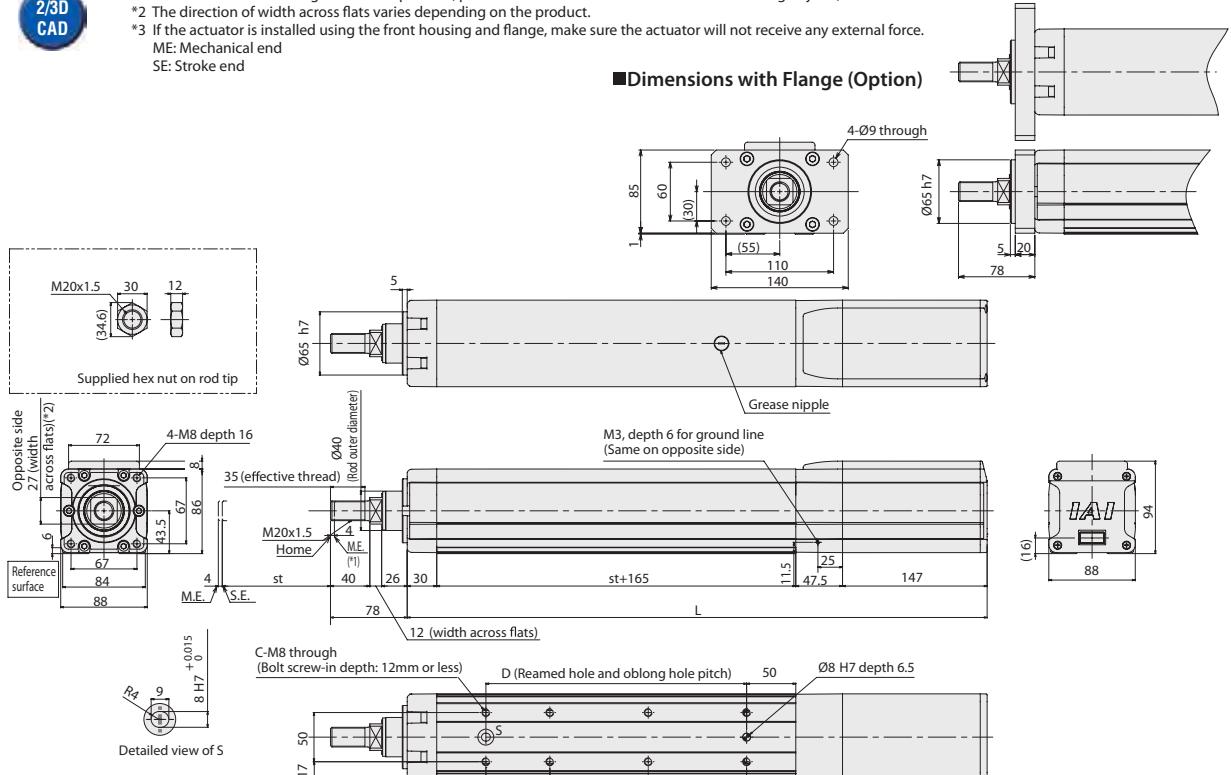

Note
If an actuator with lead 5 is installed vertically, the service life of the actuator varies significantly depending on its payload. Please refer to the correlation diagram of vertical load and traveling life shown below. (If the actuator is installed horizontally, its service life is not affected by the payload.)

■ Dimensions with Brake (Option)

■ 4 Cable Exit Directions (Option)

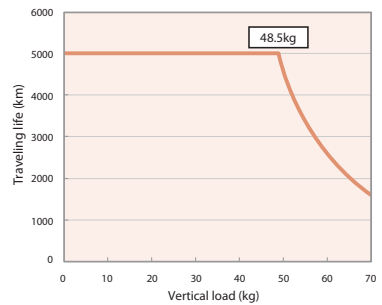
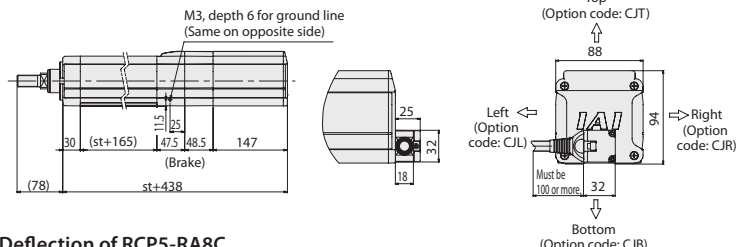

■ Rod Deflection of RCP5-RA8C

(The graph below shows the measurements of how much a horizontally installed rod would deflect when a load is applied to the end of the rod. The measured deflection includes the deflection due to the weight of the rod.)

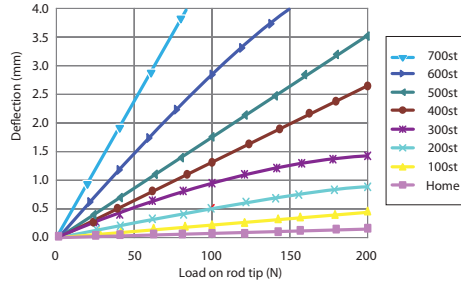

■ Dimensions and Mass by Stroke

Stroke	L	Stroke													
		50	100	150	200	250	300	350	400	450	500	550	600	650	700
Without brake	439.5	489.5	539.5	589.5	639.5	689.5	739.5	789.5	839.5	889.5	939.5	989.5	1039.5	1089.5	
	488	538	588	638	688	738	788	838	888	938	988	1038	1088	1138	
With brake	0	1	1	2	2	3	3	4	4	5	5	6	6	7	
	115	65	115	65	115	65	115	65	115	65	115	65	115	65	
A	4	6	6	8	8	10	10	12	12	14	14	16	16	18	
	115	165	215	265	315	365	415	465	515	565	615	665	715	765	
B	180	150.3	128.9	112.7	99.9	89.7	81.3	74.3	68.3	63.1	58.6	54.6	51.1	47.9	
	73.6	60.3	51.0	44.1	38.7	34.3	30.7	27.7	25.2	23.0	21.1	19.4	17.8	16.5	
C	57.0	48.6	42.5	37.8	33.8	30.5	27.6	25.2	23.1	21.2	19.5	18.1	16.7	15.5	
	18.1	15.2	13.0	11.4	10.2	9.2	8.4	7.7	7.1	6.6	6.1	5.8	5.4	5.1	
D	5.7	4.9	4.3	3.8	3.4	3.0	2.8	2.5	2.3	2.1	2.0	1.8	1.7	1.5	
	7.1	7.6	8.0	8.4	8.9	9.3	9.7	10.2	10.6	11.0	11.4	11.9	12.3	12.7	
Mass (kg)	8.3	8.7	9.1	9.6	10.0	10.4	10.9	11.3	11.7	12.1	12.6	13.0	13.4	13.9	

Applicable Controllers

The RCP5 series actuators can be operated by the controllers indicated below. Please select the type depending on your intended use.

Name	External view	Model number	Maximum number of positioning points	Input power	Reference page
Positioner type		PCON-CFA-60PWAI-NP-2-0 PCON-CFA-60PWAI-PN-2-0	512 points	DC24V	→P. 69
Pulse-train type		PCON-CFA-60PWAI-PLN-2-0 PCON-CFA-60PWAI-PLP-2-0	—		
Field network type		PCON-CFA-60PWAI-①-0-0	768 points		

*① Field network specification code (DV, CC, PR, CN, PRT, EC, EP)

RCP5-RA10C

RoboCylinder, High-thrust Rod Type, Motor Unit Coupled, Actuator Width 108mm, 24V Pulse Motor

Model	RCP5-RA10C	WA	86P			P4			
Specification	Series	Type	Encoder type	Motor type	Lead	Stroke	Applicable controller	Cable length	Options
Items			WA: Battery-less absolute specification	86P: Pulse motor, size 86□	10: 10mm 5: 5mm 2.5: 2.5mm	50: 50mm 800: 800mm (Every 50mm)	P4: PCON-CFA	N: No cable P: 1m S: 3m M: 5m X□□: Specified length R□□: Robot cable	Please refer to the options table below.

Radial Load Applicable



* Depending on the model, there may be some limitations to using the vertical mount position. Please refer to P.59 for details.



- (1) The payload assumes operation at an acceleration of 0.01G for lead 2.5, operation at an acceleration of 0.02G for lead 5 and operation at an acceleration of 0.04G for lead 10. The above values are the upper limits of acceleration/deceleration.
- (2) Please note that the RA10C requires a dedicated controller (high-thrust PCON-CFA).
- (3) The radial cylinder is equipped with a built-in guide. Please refer to the graphs shown in P. 65 and after for the allowable load mass.

Correlation Diagrams of Speed and Payload

RCP5-RA10C, Horizontal mount, PCON-CFA connected

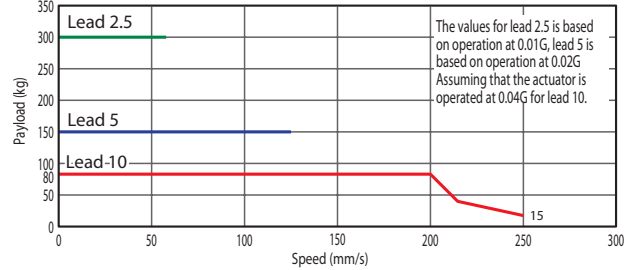

RCP5-RA10C, Vertical mount, PCON-CFA connected

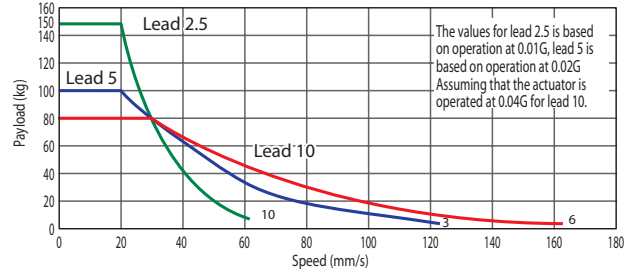

Actuator Specifications

Lead and Payload

Model number	Lead (mm)	Connected controller	Maximum payload		Maximum push force (N)	Stroke (mm)
			Horizontal (kg)	Vertical (kg)		
RCP5-RA10C-WA-86P-10-①-P4-②-③	10	PCON-CFA	80	80	1,500	50~800 (Every 50mm)
RCP5-RA10C-WA-86P-5-①-P4-②-③	5	PCON-CFA	150	100	3,000	
RCP5-RA10C-WA-86P-2.5-①-P4-②-③	2.5	PCON-CFA	300	150	6,000	

Legend: ① Stroke ② Cable length ③ Options

Stroke and Maximum Speed

Values in brackets <> are for vertical use. (Unit: mm/s)

Lead (mm)	50 (mm)	100 (mm)	150 (mm)	200~400 (Every 50mm)	450 (mm)	500 (mm)	550 (mm)	600 (mm)	650 (mm)	700 (mm)	750 (mm)	800 (mm)
10	117	167	200 <167>	250 <167>			220 <167>	200 <167>	180 <167>	160	140	120
5	83		125		110	90	80	70	60	55	50	45
2.5				63			55	50	45	40	35	30

Cable Length

Type	Cable code		
	P (1m)	S (3m)	M (5m)
Standard type		X06 (6m) ~X10 (10m)	
		X11 (11m) ~X15 (15m)	
		X16 (16m) ~X20 (20m)	
Special length		R01 (1m) ~R03 (3m)	
		R04 (4m) ~R05 (5m)	
		R06 (6m) ~R10 (10m)	
		R11 (11m) ~R15 (15m)	
		R16 (16m) ~R20 (20m)	
Robot cable		R01 (1m) ~R03 (3m)	
		R04 (4m) ~R05 (5m)	
		R06 (6m) ~R10 (10m)	
		R11 (11m) ~R15 (15m)	
		R16 (16m) ~R20 (20m)	

Options

Name	Option code	Reference page
Brake	B	→P. 11
Cable exit direction (Top)	CJT	→P. 11
Cable exit direction (Right)	CJR	→P. 11
Cable exit direction (Left)	CJL	→P. 11
Cable exit direction (Bottom)	CJB	→P. 11
Flange	FL	→P. 12
Non-motor end specification	NM	→P. 11

Actuator Specifications

Item	Description
Drive system	Ball screw \varnothing 20mm (Lead 2.5/10mm), \varnothing 16mm (Lead 5mm), rolled C10
Positioning repeatability	\pm 0.02mm
Lost motion	0.1mm or less
Rod	\varnothing 40mm Aluminum
Rod non-rotation precision (*1)	\pm 0 deg
Allowable load and torque on rod tip	Refer to table in the page on the right, refer to P. 65
Rod tip overhang distance	100mm or less
Ambient operating temperature, humidity	0 to 40°C, 85% RH or less (Non-condensing)

(*1) Rod's angular displacement in rotational direction with no applied load is shown.

Offset distance at end of rod (100mm or less)

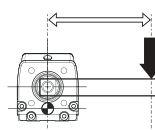

Load at end of rod

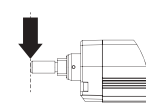

Dimensions

CAD drawings can be downloaded from the website.

www.robocylinder.de

2/3D CAD

- *1 When the rod is returning to its home position, please be careful of interference from surrounding objects, as it will travel until it reaches the ME.
- *2 The direction of width across flats varies depending on the product.
- *3 If the actuator is installed using the front housing and flange, make sure the actuator will not receive any external force.
ME: Mechanical end
SE: Stroke end

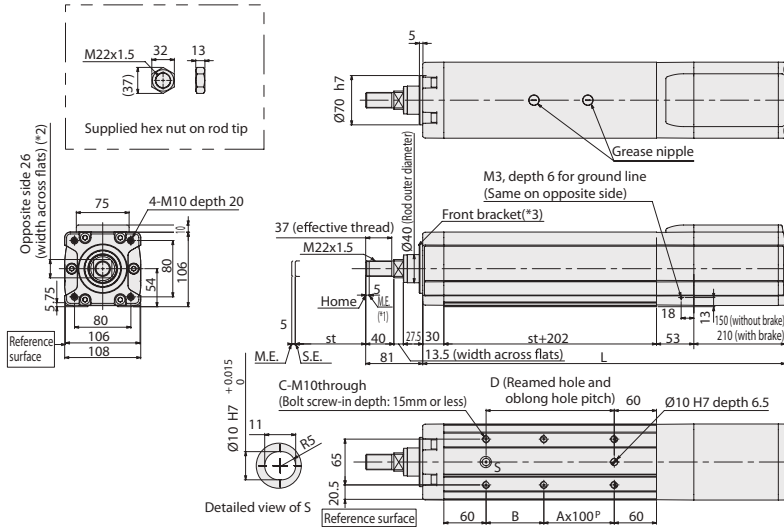

Dimensions with Flange (Option)

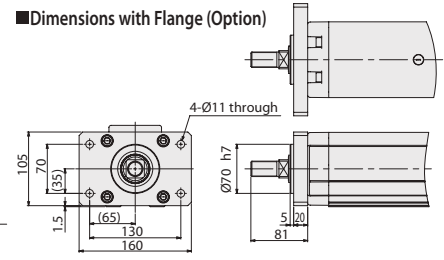

4 Cable Exit Directions (Option)

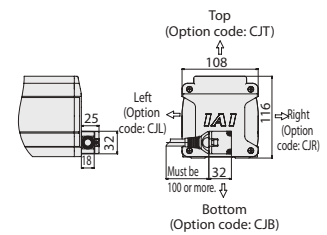

Rod Deflection of RCP5-RA10C

(The graph below shows the measurements of how much a horizontally installed rod would deflect when a load is applied to the end of the rod. The measured deflection includes the deflection due to the weight of the rod.)

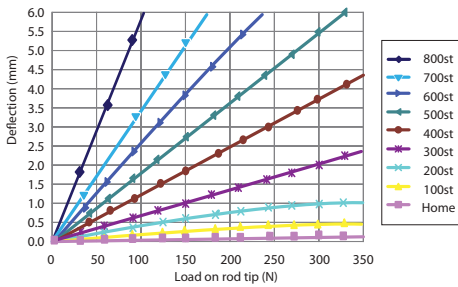

Dimensions and Mass by Stroke

Stroke	50	100	150	200	250	300	350	400	450	500	550	600	650	700	750	800	
L	Without brake	485	535	585	635	685	735	785	835	885	935	985	1035	1085	1135	1185	1235
	With brake	545	595	645	695	745	795	845	895	945	995	1045	1095	1145	1195	1245	1295
A	0	1	1	2	2	3	3	4	4	5	5	6	6	7	7	8	
B	132	82	132	82	132	82	132	82	132	82	132	82	132	82	132	82	
C	4	6	6	8	8	10	10	12	12	14	14	16	16	18	18	20	
D	132	182	232	282	332	382	432	482	532	582	632	682	732	782	832	882	
Allowable static load on rod tip (N)		316.9	268.4	232.6	205.1	183.4	165.7	151.0	138.6	128.1	119.0	111.0	103.9	97.7	92.1	87.0	82.5
	Load offset 0mm	119.1	99.1	84.7	73.8	65.3	58.5	52.8	48.1	44.0	40.5	37.5	34.8	32.4	30.2	28.3	26.5
Allowable dynamic load on rod tip (N)		100.7	85.9	74.9	66.3	59.3	53.6	48.8	44.7	41.2	38.1	35.4	32.9	30.8	28.8	27.0	25.4
	Load offset 100mm	31.8	27.0	23.4	20.7	18.5	16.8	15.3	14.1	13.1	12.2	11.4	10.7	10.1	9.6	9.1	8.6
Allowable static torque on rod tip (N·m)		10.1	8.6	7.5	6.6	5.9	5.4	4.9	4.5	4.1	3.8	3.5	3.3	3.1	2.9	2.7	2.5
	Load offset 100mm	11.5	12.2	12.9	13.6	14.3	15	15.7	16.4	17.1	17.8	18.5	19.2	19.9	20.6	21.3	22
Mass (kg)	Without brake	13.1	13.8	14.5	15.2	15.9	16.6	17.3	18	18.7	19.4	20.1	20.8	21.5	22.2	22.9	23.6
	With brake	13.1	13.8	14.5	15.2	15.9	16.6	17.3	18	18.7	19.4	20.1	20.8	21.5	22.2	22.9	23.6

Correlation Diagrams of Vertical Load and Traveling Life

- Since the RCP5-RA10C has a greater maximum thrust than other types, its service life varies significantly depending on the payload and push force applied when the actuator is installed vertically. When selecting an appropriate type from the correlation diagram of speed and payload or correlation diagram of push force and current-limiting value, check its traveling life on the correlation diagram of payload and service life as well as on the correlation diagram of push force and service life.

Note
The rated value represents the maximum value at a traveling life of 5000km. The greatest value is the maximum value at which the actuator can operate. Take note that, if an actuator is operated beyond its rating, its service life will drop as shown by the applicable graph on the right.

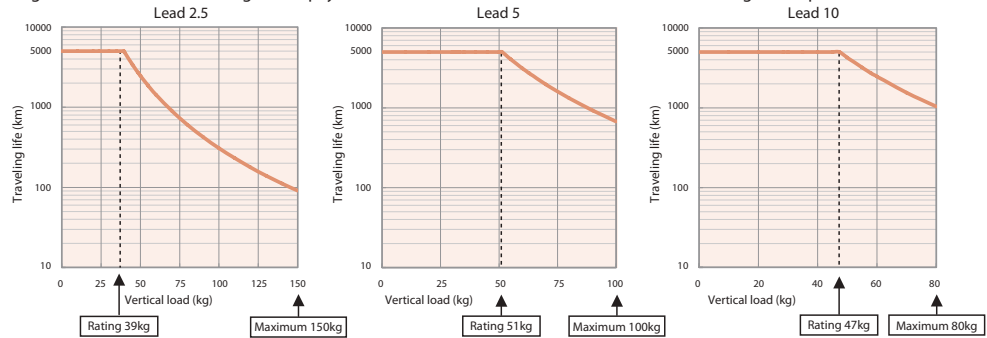

Applicable Controllers

The RCP5 series actuators can be operated by the controllers indicated below. Please select the type depending on your intended use.

Name	External view	Model number	Maximum number of positioning points	Input power	Reference page
Positioner type		PCON-CFA-86PWAI-NP-2-0 PCON-CFA-86PWAI-PN-2-0	512 points	DC24V	→ P. 69
Pulse-train type		PCON-CFA-86PWAI-PLN-2-0 PCON-CFA-86PWAI-PLP-2-0	—		
Field network type		PCON-CFA-86PWAI-①-0-0	768 points		

*① Field network specification code (DV, CC, PR, CN, PRT, EC, EP)

RCP5-RA4R

RoboCylinder, Rod Type, Side-mounted Motor Type, Actuator Width 40mm, 24V Pulse Motor

Model	RCP5	RA4R	WA	35P			P3		
Specification	Series	Type	Encoder type	Motor type	Lead	Stroke	Applicable controllers	Cable length	Options
Items			WA: Battery-less absolute specification	35P: Pulse motor, size 35□	16: 16mm 10: 10mm 5: 5mm 2.5: 2.5mm	60: 60mm 410: 410mm (Every 50mm)	P3: PCON-CA MSEP MSEL	N: No cable P: 1m S: 3m M: 5m X□: Specified length R□: Robot cable	Please refer to the options table below.

Radial Load Applicable



* Depending on the model, there may be some limitations to using the vertical mount position. Please refer to P.59 for details.



The figure above is the motor side-mounted to the left (ML).



- (1) The actuator specification displays the payload's maximum value, but it will vary depending on the acceleration. Please refer to the "Selection Guidelines" (RCP5 Payload by Speed/Acceleration Table) on P. 63.
- (2) Please refer to P. 59 for push-motion operation.
- (3) The radial cylinder is equipped with a built-in guide. Please refer to the graphs shown in P. 65 and after for the allowable load mass.

Correlation Diagrams of Speed and Payload

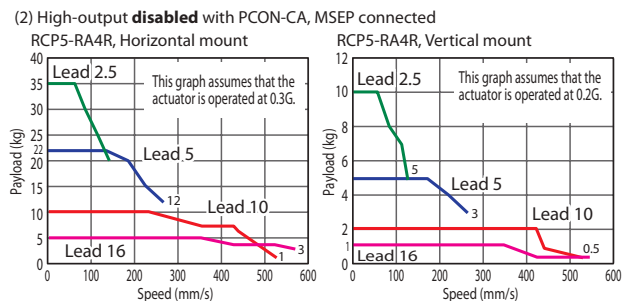
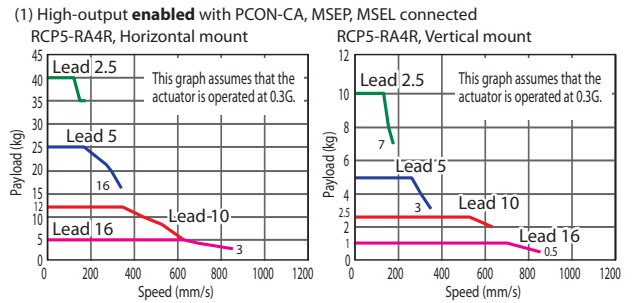

Actuator Specifications

Lead and Payload

Model number	Lead (mm)	Connected controller	Maximum payload		Maximum push force (N)	Stroke (mm)
			Horizontal (kg)	Vertical (kg)		
RCP5-RA4R-WA-35P-16-①-P3-②-③	16	High-output enabled	5	1	48	60~410 (Every 50mm)
		High-output disabled	12	2.5		
RCP5-RA4R-WA-35P-10-①-P3-②-③	10	High-output enabled	10	2	77	
		High-output disabled	25	5		
RCP5-RA4R-WA-35P-5-①-P3-②-③	5	High-output enabled	22	5	155	
		High-output disabled	40	10		
RCP5-RA4R-WA-35P-2.5-①-P3-②-③	2.5	High-output enabled	35	10	310	
		High-output disabled				

Legend: ① Stroke ② Cable length ③ Options

Stroke and Maximum Speed

(Unit: mm/s)

Lead (mm)	Connected controller	60~360 (Every 50mm)		410 (mm)
		60~360 (Every 50mm)	410 (mm)	
16	High-output enabled	840		
	High-output disabled	560		
10	High-output enabled	610		
	High-output disabled	525		
5	High-output enabled	350	340	
	High-output disabled	260		
2.5	High-output enabled	175	170	
	High-output disabled	130		

Cable Length

Type	Cable code		
	P (1m)	S (3m)	M (5m)
Standard type	X06 (6m) ~X10 (10m)		
	X11 (11m) ~X15 (15m)		
	X16 (16m) ~X20 (20m)		
Special length	R01 (1m) ~R03 (3m)		
	R04 (4m) ~R05 (5m)		
	R06 (6m) ~R10 (10m)		
	R11 (11m) ~R15 (15m)		
	R16 (16m) ~R20 (20m)		

Options

Name	Option code	Reference page
Brake	B	→P. 11
Cable exit direction (Top)	CJT	→P. 11
Cable exit direction (Outside)	CJO	→P. 11
Cable exit direction (Bottom)	CJB	→P. 11
Flange (*1)	FL	→P. 12
Tip adapter (Flange) (*1)	FFA	→P. 12
Tip adapter (Internal thread) (*1)	NFA	→P. 13
Tip adapter (Keyway) (*1)	KFA	→P. 13
Motor side-mounted to the left (Standard)	ML	→P. 11
Motor side-mounted to the right	MR	→P. 11
Non-motor end specification	NM	→P. 11

Actuator Specifications

Item	Description
Drive system	Ball screw Ø8mm, rolled C10
Positioning repeatability	±0.02mm
Lost motion	0.1mm or less
Rod	Ø20mm Aluminum
Rod non-rotation precision (*1)	±0 deg
Allowable load and torque on rod tip	Refer to table in the page on the right, refer to P. 65
Rod tip overhang distance	100mm or less
Ambient operating temperature, humidity	0 to 40°C, 85% RH or less (Non-condensing)

(*1) Rod's angular displacement in rotational direction with no applied load is shown.

Offset distance at end of rod (100mm or less)

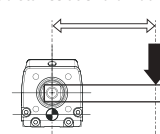

Load at end of rod

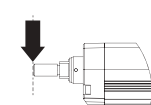

(*1) Depending on the stroke, some rod attachment options are not available. Also, when selecting the shorter strokes, please be careful of nearby objects. Some interference may occur. Please refer to P. 14.

Dimensions

CAD drawings can be downloaded from the website.

www.robocylinder.de

2/3D CAD

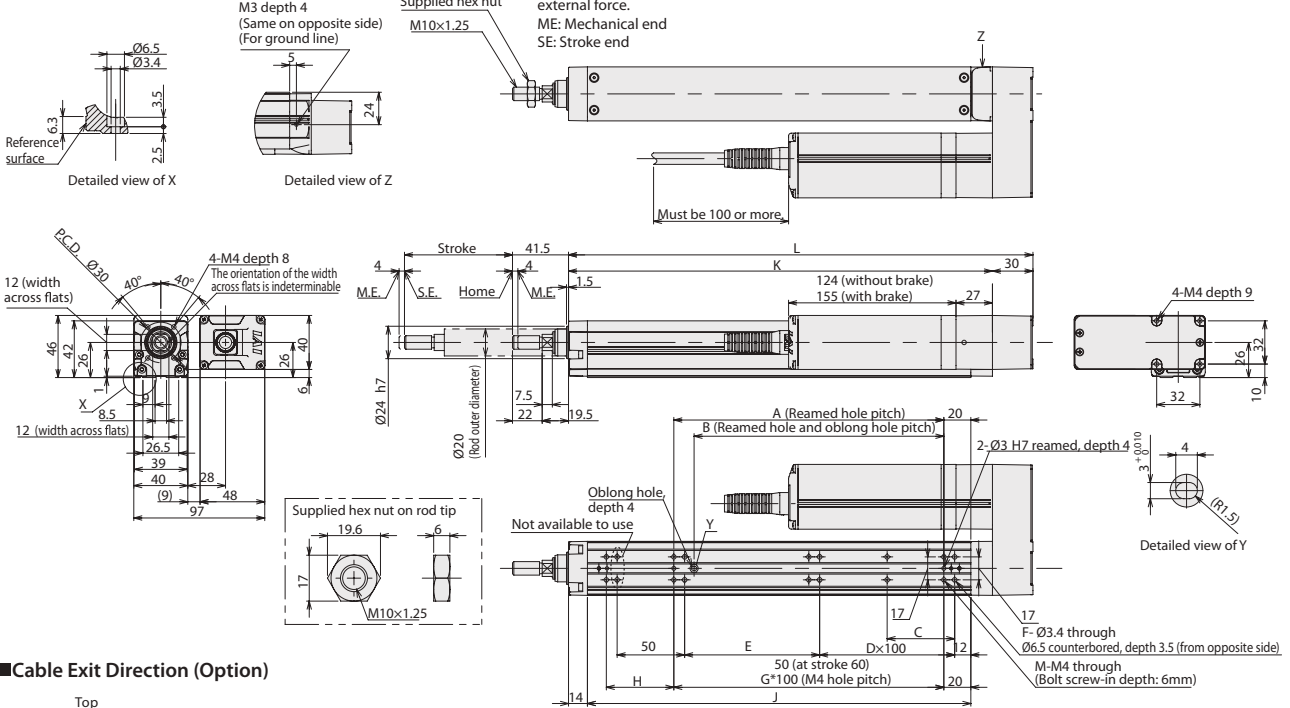

■ Cable Exit Direction (Option)

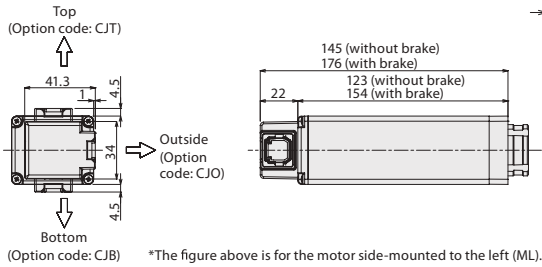

■ Rod Deflection of RCP5-RA4R (Reference Values)

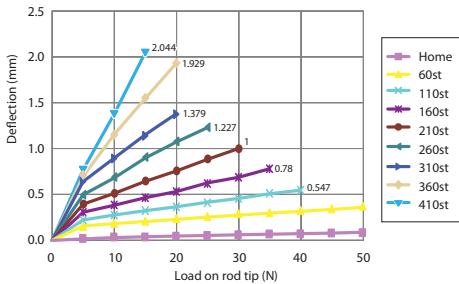

■ Dimensions and Mass by Stroke

Stroke	60	110	160	210	260	310	360	410
L	194	244	294	344	394	444	494	544
A	50	100	100	200	200	300	300	400
B	35	85	85	185	185	285	285	385
C	25	50	50	50	50	50	50	50
D	0	0	1	1	2	2	3	3
E	50	100	50	100	50	100	50	100
F	8	8	10	10	12	12	14	14
G	-	1	1	2	2	3	3	4
H	50	50	100	50	100	50	100	50
J	134	184	234	284	334	384	434	484
K	164	214	264	314	364	414	464	514
M	6	6	6	8	8	10	10	12
Allowable static load on rod tip (N)	55.8	44.6	37.1	31.7	27.6	24.3	21.7	19.5
Allowable dynamic load on rod tip (N)	Load offset 0mm	25.4	19.5	15.5	12.8	10.8	9.2	7.9
	Load offset 100mm	16.5	14.5	12.4	10.7	9.2	8.0	7.0
Allowable static torque on rod tip (N-m)	5.6	4.5	3.8	3.2	2.8	2.5	2.3	2.1
Allowable dynamic torque on rod tip (N-m)	1.7	1.5	1.2	1.1	0.9	0.8	0.7	0.6
Mass (kg)	Without brake	1.4	1.5	1.6	1.7	1.9	2.0	2.2
	With brake	1.6	1.7	1.8	1.9	2.1	2.2	2.4

Applicable Controllers

The RCP5 series actuators can be operated by the controllers indicated below. Please select the type depending on your intended use.

Name	External view	Model number	Max. number of controlled axes	Maximum number of positioning points	Input power	Reference page
Positioner type (High-output specification)		PCON-CA-35PWAI-①-2-0	1	512 points	DC24V	→P. 69
Pulse train type (High-output specification)		PCON-CA-35PWAI-PL②-2-0				
Field network type (High-output specification)		PCON-CA-35PWAI-③-0-0				
Solenoid valve multi-axis type (PIO specification)		MSEP-④-①---①-2-0	C: 8 (4 when high-output enabled)	3 points		→P. 77
Positioner multi-axis type (Field network specification)		MSEP-④-①---③-0-0				
Program control multi-axis safety category type		MSEL-PG-1-35PWAI-①-2-4	4	30000 points	Single-phase AC 100V~230V	→P. 87
Program control multi-axis safety category type (w/ network board)		MSEL-PG-1-35PWAI-③-0-4				

*Above MSEL models are for single-axis specification *① I/O type (NP/PN) *③ Number of axes
 *② Field network specification code *④ C or LC *④ N (NPN specification) or P (PNP specification) code
 *The high output enabled operation is only available when the "High-output setting specs" is selected in the MSEP-C/LC.

RCP5-RA6R

RoboCylinder, Rod Type, Side-mounted Motor Type, Actuator Width 58mm, 24V Pulse Motor

Model	RCP5	RA6R	WA	42P			P3		
Specification	Series	Type	Encoder type	Motor type	Lead	Stroke	Applicable controllers	Cable length	Options
Items			WA: Battery-less absolute specification	42P: Pulse motor, size 42□	20: 20mm 12: 12mm 6: 6mm 3: 3mm	65: 65mm 415: 415mm (Every 50mm)	P3: PCON-CA MSEP MSEL	N: No cable P: 1m S: 3m M: 5m X□: Specified length R□: Robot cable	Please refer to the options table below.

Radial Load Applicable



* Depending on the model, there may be some limitations to using the vertical mount position. Please refer to P.59 for details.



The figure above is the motor side-mounted to the left (ML).

POINT
Note on selection

- The actuator specification displays the payload's maximum value, but it will vary depending on the acceleration. Please refer to the "Selection Guidelines" (RCP5 Payload by Speed/Acceleration Table) on P. 63.
- Please refer to P. 59 for push-motion operation.
- The radial cylinder is equipped with a built-in guide. Please refer to the graphs shown in P. 65 and after for the allowable load mass.

Correlation Diagrams of Speed and Payload

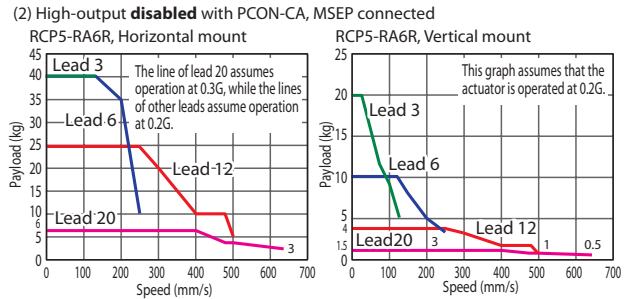
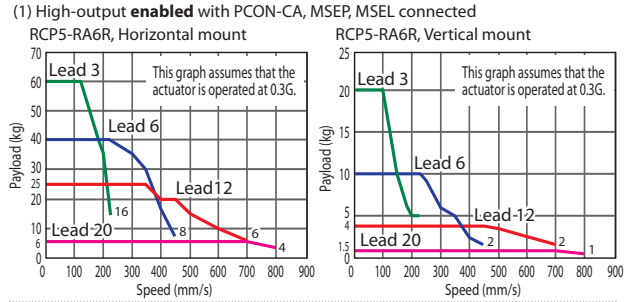

Actuator Specifications

Lead and Payload

Model number	Lead (mm)	Connected controller	Maximum payload		Maximum push force (N)	Stroke (mm)
			Horizontal (kg)	Vertical (kg)		
RCP5-RA6R-WA-42P-20-①-P3-②-③	20	High-output enabled	6	1.5	56	65~415 (Every 50mm)
		High-output disabled				
RCP5-RA6R-WA-42P-12-①-P3-②-③	12	High-output enabled	25	4	93	
		High-output disabled				
RCP5-RA6R-WA-42P-6-①-P3-②-③	6	High-output enabled	40	10	185	
		High-output disabled				
RCP5-RA6R-WA-42P-3-①-P3-②-③	3	High-output enabled	60	20	370	
		High-output disabled	40			

Legend: ① Stroke ② Cable length ③ Options

Stroke and Maximum Speed

(Unit: mm/s)

Lead (mm)	Connected controller	Maximum speed	
		65~365 (Every 50mm)	415 (mm)
20	High-output enabled	800	
	High-output disabled	640	
12	High-output enabled	700	
	High-output disabled	500	
6	High-output enabled	450	
	High-output disabled	250	
3	High-output enabled	225	220
	High-output disabled	125	

Cable Length

Type	Cable code		
	P (1m)	S (3m)	M (5m)
Standard type			
Special length			
Robot cable			

Options

Name	Option code	Reference page
Brake	B	→P. 11
Cable exit direction (Top)	CJT	→P. 11
Cable exit direction (Outside)	CJO	→P. 11
Cable exit direction (Bottom)	CJB	→P. 11
Flange (*1)	FL	→P. 12
Tip adapter (Flange) (*1)	FFA	→P. 12
Tip adapter (Internal thread) (*1)	NFA	→P. 13
Tip adapter (Keyway) (*1)	KFA	→P. 13
Motor side-mounted to the left (Standard)	ML	→P. 11
Motor side-mounted to the right	MR	→P. 11
Non-motor end specification	NM	→P. 11

Actuator Specifications

Item	Description
Drive system	Ball screw Ø10mm, rolled C10
Positioning repeatability (*1)	±0.02mm (±0.03mm)
Lost motion	0.1mm or less
Rod	Ø25mm Aluminum
Rod non-rotation precision (*2)	±0 deg
Allowable load and torque on rod tip	Refer to table in the page on the right, refer to P. 65
Rod tip overhang distance	100mm or less
Ambient operating temperature, humidity	0 to 40°C, 85% RH or less (Non-condensing)

(*1) The values in brackets [] are for Lead 20.

(*2) Rod's angular displacement in rotational direction with no applied load is shown.

Offset distance at end of rod (100mm or less)

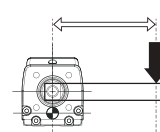

Load at end of rod

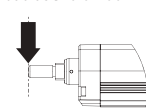

(*1) Depending on the stroke, some rod attachment options are not available. Also, when selecting the shorter strokes, please be careful of nearby objects. Some interference may occur. Please refer to P. 14.

Dimensions

CAD drawings can be downloaded from the website. www.robocylinder.de



- *1 When the rod is returning to its home position, please be careful of interference from surrounding objects, as it will travel until it reaches the ME.
- *2 The direction of width across flats varies depending on the product.
- *3 If the actuator is installed using the front housing and flange, make sure the actuator will not receive any external force.

ME: Mechanical end
SE: Stroke end

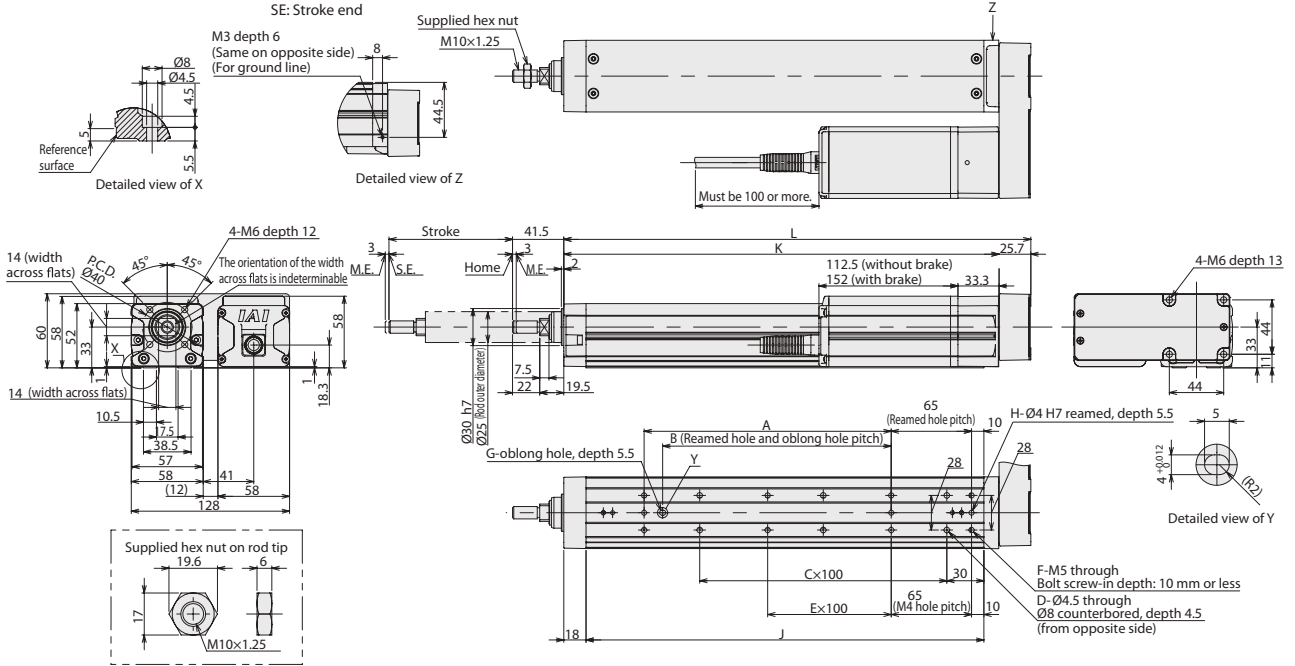

■ Cable Exit Direction (Option)

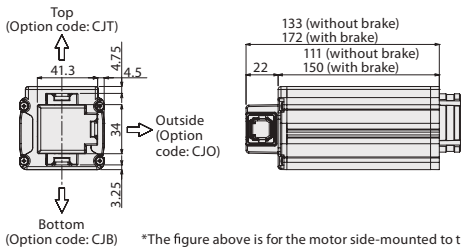

*The figure above is for the motor side-mounted to the left (ML).

■ Rod Deflection of RCP5-RA6R (Reference Values)

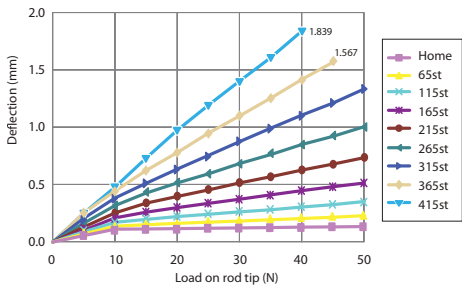

■ Dimensions and Mass by Stroke

Stroke	65	115	165	215	265	315	365	415
L	228	278	328	378	428	478	528	578
A	0	100	100	200	200	300	300	400
B	0	85	85	185	185	285	285	385
C	1	1	2	2	3	3	4	4
D	4	4	6	6	8	8	10	10
E	0	0	0	1	1	2	2	3
F	4	6	6	8	8	10	10	12
G	0	1	1	1	1	1	1	1
H	2	3	3	3	3	3	3	3
J	172	222	272	322	372	422	472	522
K	202.3	252.3	302.3	352.3	402.3	452.3	502.3	552.3
Allowable static load on rod tip (N)	113.8	92.6	78.0	67.3	59.0	52.5	47.2	42.8
Allowable dynamic load on rod tip (N)	45.7	36.3	29.8	25.1	21.6	18.8	16.6	14.7
Allowable static torque on rod tip (N-m)	11.5	9.4	7.9	6.8	6.0	5.4	4.9	4.5
Allowable dynamic torque on rod tip (N-m)	3.2	2.8	2.5	2.1	1.9	1.7	1.5	1.3
Mass (kg)	Without brake	2.2	2.4	2.6	2.8	3.0	3.3	3.5
	With brake	2.4	2.6	2.8	3.0	3.2	3.5	3.7

Applicable Controllers

The RCP5 series actuators can be operated by the controllers indicated below. Please select the type depending on your intended use.

Name	External view	Model number	Max. number of controlled axes	Maximum number of positioning points	Input power	Reference page
Positioner type (High-output specification)		PCON-CA-42PWAI-①-2-0	1	512 points	DC24V	→P. 69
Pulse train type (High-output specification)		PCON-CA-42PWAI-PL②-2-0		768 points		
Field network type (High-output specification)		PCON-CA-42PWAI-③-0-0				
Solenoid valve multi-axis type (PIO specification)		MSEP-④-①-①-①-2-0	C: 8 (4 when high-output enabled) LC: 6 (3 when high-output enabled)	3 points	→P. 77	
Positioner multi-axis type (Field network specification)		MSEP-④-①-①-①-0-0		256 points		
Program control multi-axis safety category type		MSEL-PG-1-42PWAI-①-2-4	4	30000 points	Single-phase AC 100V~230V	→P. 87
Program control multi-axis safety category type (w/ network board)		MSEL-PG-1-42PWAI-③-0-4				

*Above MSEL models are for single-axis specification *① I/O type (NP/PN) *② Number of axes
 *③ Field network specification code *④ C or LC *⑤ N (NPN specification) or P (PNP specification) code
 *The high output enabled operation is only available when the "High-output setting specs" is selected in the MSEP-C/LC.

RCP5-RA7R

RoboCylinder, Rod Type, Side-mounted Motor Type, Actuator Width 73mm, 24V Pulse Motor

Model	RCP5	RA7R	WA	56P			P3		
Specification	Series	Type	Encoder type	Motor type	Lead	Stroke	Applicable controllers	Cable length	Options
Items			WA: Battery-less absolute specification	56P: Pulse motor, size 56□	24: 24mm 16: 16mm 8: 8mm 4: 4mm	70: 70mm 520: 520mm (Every 50mm)	P3: PCON-CA MSEP MSEL	N: No cable P: 1m S: 3m M: 5m X□: Specified length R□: Robot cable	Please refer to the options table below.

Radial Load Applicable

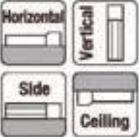

* Depending on the model, there may be some limitations to using the vertical mount position. Please refer to P.59 for details.

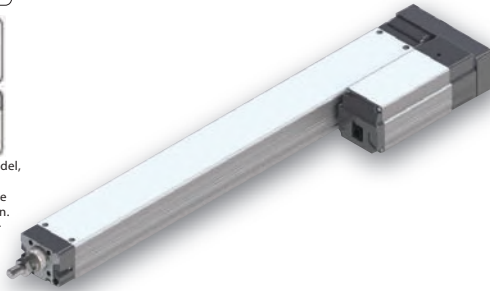

The figure above is the motor side-mounted to the left (ML).

- POINT**
Note on selection
- (1) The actuator specification displays the payload's maximum value, but it will vary depending on the acceleration. Please refer to the "Selection Guidelines" (RCP5 Payload by Speed/Acceleration Table) on P. 63.
 - (2) Please refer to P. 59 for push-motion operation.
 - (3) The radial cylinder is equipped with a built-in guide. Please refer to the graphs shown in P. 65 and after for the allowable load mass.

Correlation Diagrams of Speed and Payload

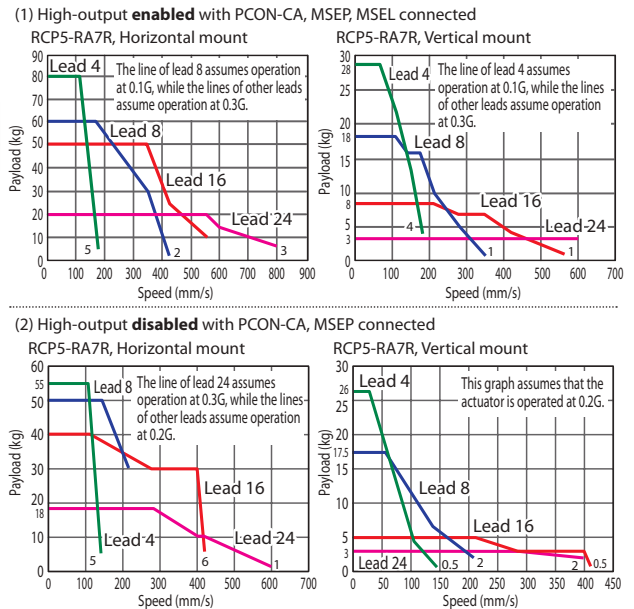

Actuator Specifications

Lead and Payload

Model number	Lead (mm)	Connected controller	Maximum payload		Maximum push force (N)	Stroke (mm)
			Horizontal (kg)	Vertical (kg)		
RCP5-RA7R-WA-56P-24-①-P3-②-③	24	High-output enabled	20	3	182	70~520 (Every 50mm)
		High-output disabled	18	3		
RCP5-RA7R-WA-56P-16-①-P3-②-③	16	High-output enabled	50	8	273	
		High-output disabled	40	5		
RCP5-RA7R-WA-56P-8-①-P3-②-③	8	High-output enabled	60	18	547	
		High-output disabled	50	17.5		
RCP5-RA7R-WA-56P-4-①-P3-②-③	4	High-output enabled	80	28	1094	
		High-output disabled	55	26		

Legend: ① Stroke ② Cable length ③ Options

Stroke and Maximum Speed

Values in brackets < > are for vertical use. (Unit: mm/s)

Lead (mm)	Connected controller	70~520 (Every 50mm)
24	High-output enabled	800 <600>
	High-output disabled	600 <400>
16	High-output enabled	560
	High-output disabled	420
8	High-output enabled	420 <350>
	High-output disabled	210
4	High-output enabled	175
	High-output disabled	140

Cable Length

Type	Cable code
Standard type	P (1m) S (3m) M (5m)
Special length	X06 (6m) ~X10 (10m)
	X11 (11m) ~X15 (15m)
	X16 (16m) ~X20 (20m)
Robot cable	R01 (1m) ~R03 (3m)
	R04 (4m) ~R05 (5m)
	R06 (6m) ~R10 (10m)
	R11 (11m) ~R15 (15m)
	R16 (16m) ~R20 (20m)

Options

Name	Option code	Reference page
Brake	B	→P. 11
Cable exit direction (Top)	CJT	→P. 11
Cable exit direction (Outside)	CJO	→P. 11
Cable exit direction (Bottom)	CJB	→P. 11
Flange (*1)	FL	→P. 12
Tip adapter (Flange) (*1)	FFA	→P. 12
Tip adapter (Internal thread) (*1)	NFA	→P. 13
Tip adapter (Keyway) (*1)	KFA	→P. 13
Motor side-mounted to the left (Standard)	ML	→P. 11
Motor side-mounted to the right	MR	→P. 11
Non-motor end specification	NM	→P. 11

Actuator Specifications

Item	Description
Drive system	Ball screw Ø12mm, rolled C10
Positioning repeatability (*1)	±0.02mm [±0.03mm]
Lost motion	0.1mm or less
Rod	Ø30mm Aluminum
Rod non-rotation precision (*2)	±0 deg
Allowable load and torque on rod tip	Refer to table in the page on the right, refer to P. 65
Rod tip overhang distance	100mm or less
Ambient operating temperature, humidity	0 to 40°C, 85% RH or less (Non-condensing)

(*1) The values in brackets [] are for Lead 24.

(*2) Rod's angular displacement in rotational direction with no applied load is shown.

Offset distance at end of rod (100mm or less)

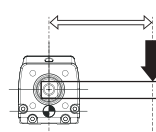

Load at end of rod

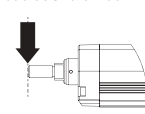

(*1) Depending on the stroke, some rod attachment options are not available. Also, when selecting the shorter strokes, please be careful of nearby objects. Some interference may occur. Please refer to P. 14.

Dimensions

CAD drawings can be downloaded from the website.

www.robocylinder.de

2/3D CAD

- *1 When the rod is returning to its home position, please be careful of interference from surrounding objects, as it will travel until it reaches the ME.
 - *2 The direction of width across flats varies depending on the product.
 - *3 If the actuator is installed using the front housing and flange, make sure the actuator will not receive any external force.
- ME: Mechanical end
SE: Stroke end

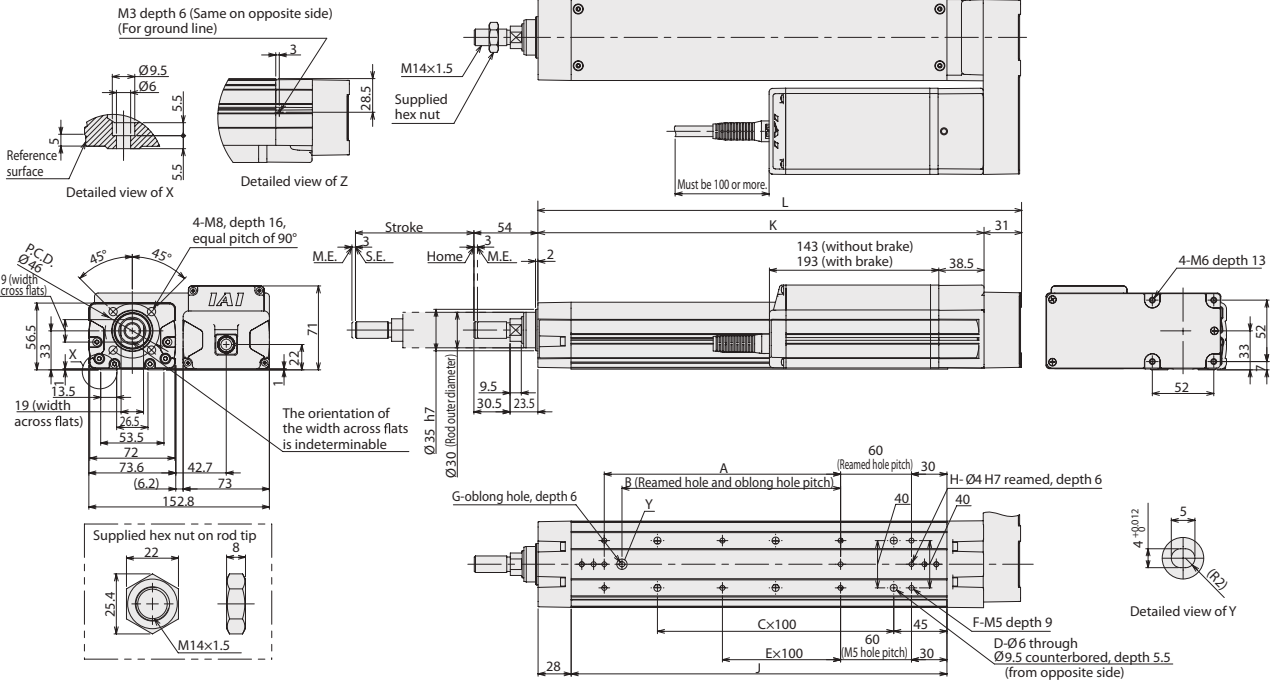

■ Cable Exit Direction (Option)

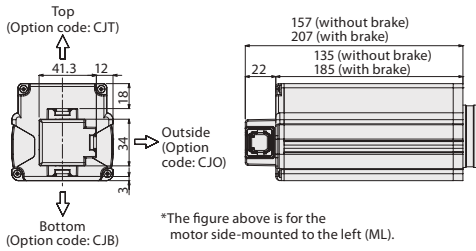

■ Rod Deflection of RCP5-RA7R

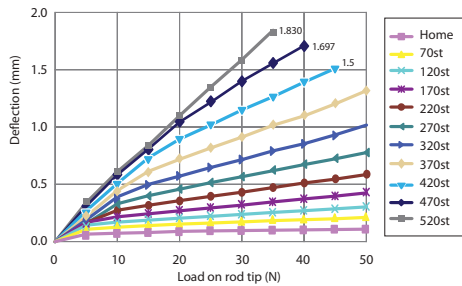

■ Dimensions and Mass by Stroke

Stroke	70	120	170	220	270	320	370	420	470	520
L	258	308	358	408	458	508	558	608	658	708
A	0	100	100	200	200	300	300	400	400	500
B	0	85	85	185	185	285	285	385	385	485
C	1	2	2	3	3	4	4	5	5	5
D	4	4	6	6	8	8	10	10	12	12
E	0	0	0	1	1	2	2	3	3	4
F	4	6	6	8	8	10	10	12	12	14
G	0	1	1	1	1	1	1	1	1	1
H	2	3	3	3	3	3	3	3	3	3
J	168	218	268	318	368	418	468	518	568	618
K	227	277	327	377	427	477	527	577	627	677
Allowable static load on rod tip (N)	119.2	97.7	82.8	71.6	63.0	56.2	50.6	46.0	42.2	38.8
Allowable dynamic load on rod tip (N)	Load offset 0mm									
	Load offset 100mm									
Allowable static torque on rod tip (N·m)	12.1	10.0	8.5	7.4	6.5	5.9	5.3	4.9	4.5	4.1
Allowable dynamic torque on rod tip (N·m)	3.4	3.0	2.6	2.2	2.0	1.7	1.6	1.4	1.3	1.2
Mass (kg)	Without brake									
	With brake									

Applicable Controllers

The RCP5 series actuators can be operated by the controllers indicated below. Please select the type depending on your intended use.

Name	External view	Model number	Max. number of controlled axes	Maximum number of positioning points	Input power	Reference page
Positioner type (High-output specification)		PCON-CA-56PWAI-①-2-0	1	512 points	DC24V	→P. 69
Pulse train type (High-output specification)		PCON-CA-56PWAI-PL②-2-0				
Field network type (High-output specification)		PCON-CA-56PWAI-③-0-0				
Solenoid valve multi-axis type (PIO specification)		MSEP-④-⑤--①-2-0	C: 8 (4 when high-output enabled) LC: 6 (3 when high-output enabled)	3 points	DC24V	→P. 77
Positioner multi-axis type (Field network specification)		MSEP-④-⑤--③-0-0				
Program control multi-axis safety category type		MSEL-PG-1-56PWAI-①-2-4	4	30000 points	Single-phase AC 100V~230V	→P. 87
Program control multi-axis safety category type (w/ network board)		MSEL-PG-1-56PWAI-③-0-4				

*Above MSEL models are for single-axis specification *① I/O type (NP/PN) *③ Number of axes
 *② Field network specification code *④ C or LC *⑤ N (NPN specification) or P (PNP specification) code
 *The high output enabled operation is only available when the "High-output setting specs" is selected in the MSEP-C/LC.

RCP5-RA8R

RoboCylinder, High-thrust Rod Type, Side-mounted Motor Type, Actuator Width 88mm, 24V Pulse Motor

Model	RCP5	RA8R	WA	60P			P4		
Specification	Series	Type	Encoder type	Motor type	Lead	Stroke	Applicable controller	Cable length	Options
Items			WA: Battery-less absolute specification	60P: Pulse motor, size 60□	20: 20mm 10: 10mm 5: 5mm	50: 50mm 700: 700mm (Every 50mm)	P4: PCON-CFA	N: No cable P: 1m S: 3m M: 5m X□□: Specified length R□□: Robot cable	Please refer to the options table below.

Radial Load Applicable

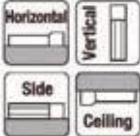

* Depending on the model, there may be some limitations to using the vertical mount position. Please refer to P.59 for details.



The figure above is the motor side-mounted to the left (ML).

- POINT**
Note on selection
- (1) The payload assumes operation at an acceleration of 0.1G for lead 5 and operation at an acceleration of 0.2G for lead 10 and lead 20. The above values are the upper limits of acceleration/deceleration.
 - (2) Please note that the RA8R requires a dedicated controller (high-thrust PCON-CFA).
 - (3) The radial cylinder is equipped with a built-in guide.

Correlation Diagrams of Speed and Payload

RCP5-RA8R, Horizontal mount, PCON-CFA connected

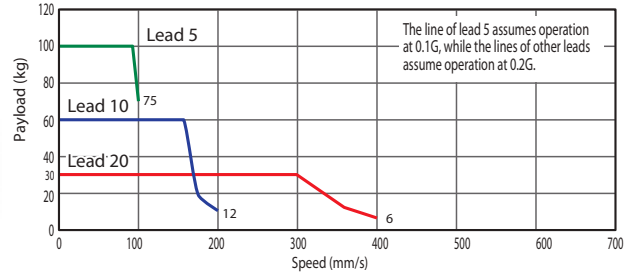

RCP5-RA8R, Vertical mount, PCON-CFA connected

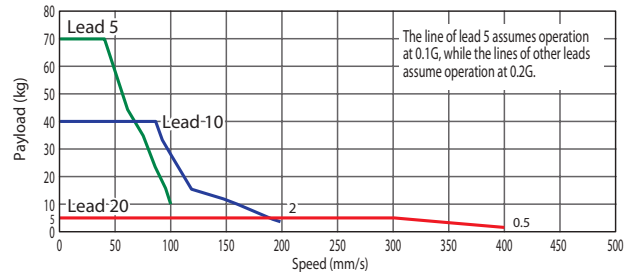

Actuator Specifications

Lead and Payload

Model number	Lead (mm)	Connected controller	Maximum payload		Maximum push force (N)	Stroke (mm)
			Horizontal (kg)	Vertical (kg)		
RCP5-RA8R-WA-60P-20-①-P4-②-③	20	PCON-CFA	30	5	500	50~700 (Every 50mm)
RCP5-RA8R-WA-60P-10-①-P4-②-③	10	PCON-CFA	60	40	1,000	
RCP5-RA8R-WA-60P-5-①-P4-②-③	5	PCON-CFA	100	70	2,000	

Legend: ① Stroke ② Cable length ③ Options

Stroke and Maximum Speed

(Unit: mm/s)

Lead (mm)	50 (mm)	100~450 (mm)	500 (mm)	550 (mm)	600 (mm)	650 (mm)	700 (mm)
20	280	400	360	320	280	240	220
10	200	180	160	140	120	110	
5	100	90	80	70	60	55	

Cable Length

Type	Cable code		
Standard type	P (1m)	S (3m)	M (5m)
Special length	X06 (6m) ~X10 (10m)		
	X11 (11m) ~X15 (15m)		
	X16 (16m) ~X20 (20m)		
Robot cable	R01 (1m) ~R03 (3m)		
	R04 (4m) ~R05 (5m)		
	R06 (6m) ~R10 (10m)		
	R11 (11m) ~R15 (15m)		
	R16 (16m) ~R20 (20m)		

Options

Name	Option code	Reference page
Brake	B	→P. 11
Cable exit direction (Top)	CJT	→P. 11
Cable exit direction (Outside)	CJO	→P. 11
Cable exit direction (Bottom)	CJB	→P. 11
Motor side-mounted to the left (Standard)	ML	→P. 11
Motor side-mounted to the right	MR	→P. 11
Flange	FL	→P. 12
Non-motor end specification	NM	→P. 11

Actuator Specifications

Item	Description
Drive system	Ball screw Ø16mm, rolled C10
Positioning repeatability	±0.02mm
Lost motion	0.1mm or less
Rod	Ø40mm Aluminum
Rod non-rotation precision (*1)	±0 deg
Allowable load and torque on rod tip	Refer to table in the page on the right, refer to P. 65
Rod tip overhang distance	100mm or less
Ambient operating temperature, humidity	0 to 40°C, 85% RH or less (Non-condensing)

(*1) Rod's angular displacement in rotational direction with no applied load is shown.

Offset distance at end of rod (100mm or less)

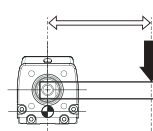

Load at end of rod

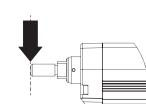

Dimensions

CAD drawings can be downloaded from the website.

www.robocylinder.de



- *1 When the rod is returning to its home position, please be careful of interference from surrounding objects, as it will travel until it reaches the ME.
- *2 The direction of width across flats varies depending on the product.
- *3 If the actuator is installed using the front housing and flange, make sure the actuator will not receive any external force.
ME: Mechanical end
SE: Stroke end

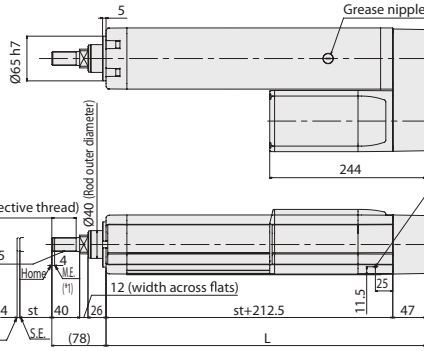
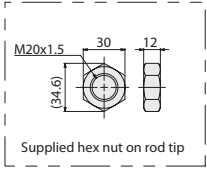

Dimensions with Flange (Option)

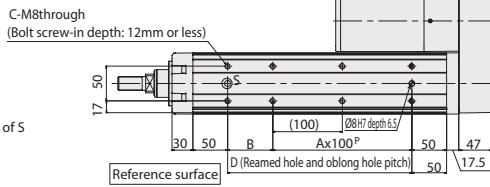
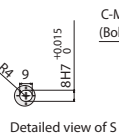
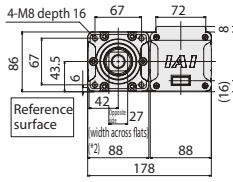
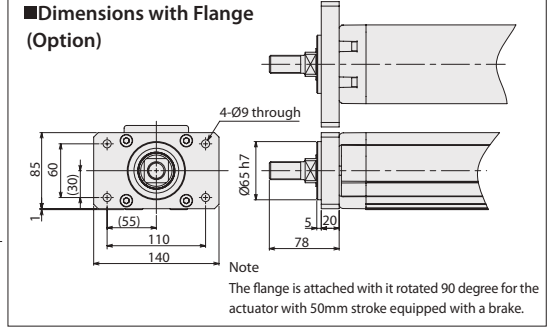

Dimensions with Brake (Option)

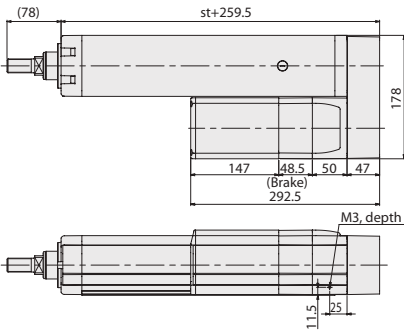

3 Cable Exit Directions (Option)

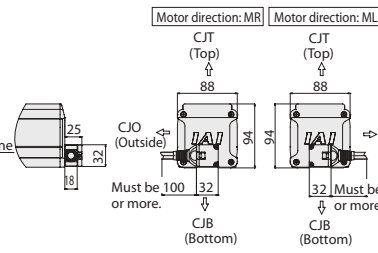

Note
If an actuator with lead 5 is installed vertically, the service life of the actuator varies significantly depending on its payload. Please refer to the correlation diagram of vertical load and traveling life shown below.
(If the actuator is installed horizontally, its service life is not affected by the payload.)

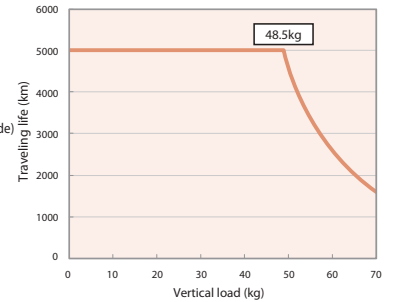

Rod Deflection of RCP5-RA8R

(The graph below shows the measurements of how much a horizontally installed rod would deflect when a load is applied to the end of the rod. The measured deflection includes the deflection due to the weight of the rod.)

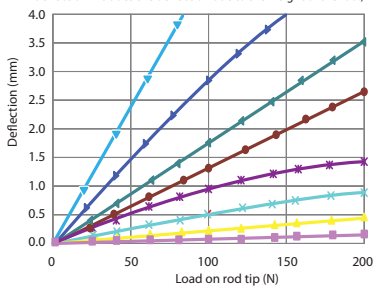

Dimensions and Mass by Stroke

Stroke	50	100	150	200	250	300	350	400	450	500	550	600	650	700
L	309.5	359.5	409.5	459.5	509.5	559.5	609.5	659.5	709.5	759.5	809.5	859.5	909.5	959.5
A	0	1	1	2	2	3	3	4	4	5	5	6	6	7
B	115	65	115	65	115	65	115	65	115	65	115	65	115	65
C	4	6	6	8	8	10	10	12	12	14	14	16	16	18
D	115	165	215	265	315	365	415	465	515	565	615	665	715	765
Allowable static load on rod tip (N)	180	150.3	128.9	112.7	99.9	89.7	81.3	74.3	68.3	63.1	58.6	54.6	51.1	47.9
Allowable dynamic load on rod tip (N)	Load offset 0mm	73.6	60.3	51.0	44.1	38.7	34.3	30.7	27.7	25.2	23.0	21.1	19.4	17.8
	Load offset 100mm	57.0	48.6	42.5	37.8	33.8	30.5	27.6	25.2	23.1	21.2	19.5	18.1	16.7
Allowable static torque on rod tip (N·m)	18.1	15.2	13.0	11.4	10.2	9.2	8.4	7.7	7.1	6.6	6.1	5.8	5.4	5.1
Allowable dynamic torque on rod tip (N·m)		5.7	4.9	4.3	3.8	3.4	3.0	2.8	2.5	2.3	2.1	2.0	1.8	1.7
		5.7	4.9	4.3	3.8	3.4	3.0	2.8	2.5	2.3	2.1	2.0	1.8	1.7
Mass (kg)	Without brake	8.6	9.0	9.4	9.8	10.3	10.7	11.1	11.6	12.0	12.4	12.9	13.3	13.7
	With brake	9.6	10.0	10.4	10.9	11.3	11.7	12.2	12.6	13.0	13.4	13.9	14.3	14.7

Applicable Controllers

The RCP5 series actuators can be operated by the controllers indicated below. Please select the type depending on your intended use.

Name	External view	Model number	Maximum number of positioning points	Input power	Reference page
Positioner type		PCON-CFA-60PWAI-NP-2-0 PCON-CFA-60PWAI-PN-2-0	512 points	DC24V	→P. 69
Pulse-train type		PCON-CFA-60PWAI-PLN-2-0 PCON-CFA-60PWAI-PLP-2-0	—		
Field network type		PCON-CFA-60PWAI-①-0-0	768 points		

*① Field network specification code (DV, CC, PR, CN, PRT, EC, EP)

RCP5-RA10R

RoboCylinder, High-thrust Rod Type, Side-mounted Motor Type, Actuator Width 108mm, 24V Pulse Motor

Model	RCP5-RA10R	WA	86P			P4			
Specification	Series	Type	Encoder type	Motor type	Lead	Stroke	Applicable controller	Cable length	Options
Items			WA: Battery-less absolute specification	86P: Pulse motor, size 86□	10: 10mm 5: 5mm 2.5: 2.5mm	50: 50mm 800: 800mm (Every 50mm)	P4: PCON-CFA	N: No cable P: 1m S: 3m M: 5m X□: Specified length R□: Robot cable	Please refer to the options table below.

Radial Load Applicable

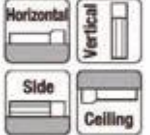

* Depending on the model, there may be some limitations to using the vertical mount position. Please refer to P.59 for details.

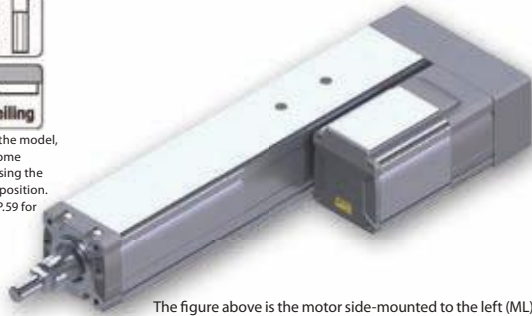

The figure above is the motor side-mounted to the left (ML).

- POINT**
Note on selection
- The payload assumes operation at an acceleration of 0.01G for lead 2.5, operation at an acceleration of 0.02G for lead 5 and operation at an acceleration of 0.04G for lead 10. The above values are the upper limits of acceleration/deceleration.
 - Please note that the RA10R requires a dedicated controller (high-thrust PCON-CFA).
 - The radial cylinder is equipped with a built-in guide. Please refer to the graphs shown in P. 65 and after for the allowable load mass.

Correlation Diagrams of Speed and Payload

RCP5-RA10R, Horizontal mount, PCON-CFA connected

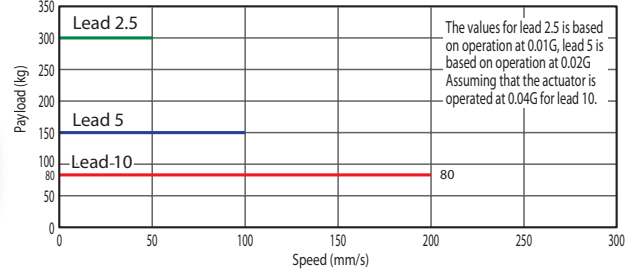

RCP5-RA10R, Vertical mount, PCON-CFA connected

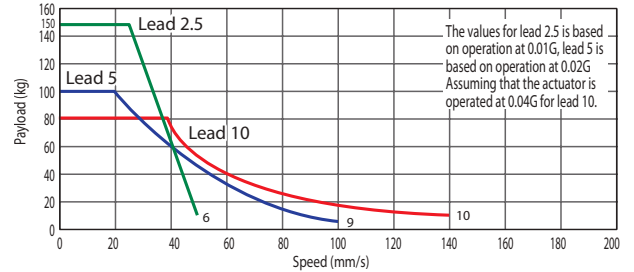

Actuator Specifications

Lead and Payload

Model number	Lead (mm)	Connected controller	Maximum payload		Maximum push force (N)	Stroke (mm)
			Horizontal (kg)	Vertical (kg)		
RCP5-RA10R-WA-86P-10-①-P4-②-③	10	PCON-CFA	80	80	1,500	50~800 (Every 50mm)
RCP5-RA10R-WA-86P-5-①-P4-②-③	5	PCON-CFA	150	100	3,000	
RCP5-RA10R-WA-86P-2.5-①-P4-②-③	2.5	PCON-CFA	300	150	6,000	

Legend: ① Stroke ② Cable length ③ Options

Stroke and Maximum Speed

Values in brackets <> are for vertical use. (Unit: mm/s)

Lead (mm)	50 (mm)	100 (mm)	150 (mm)	200~400 (Every 50mm)	450 (mm)	500 (mm)	550 (mm)	600 (mm)	650 (mm)	700 (mm)	750 (mm)	800 (mm)
10	117	167 (<140>)		200 (<140>)					180 (<140>)	160 (<140>)	140	120
5	83		100		90	80	70	60	55	50	45	
2.5				50					45	40	35	30

Cable Length

Type	Cable code		
Standard type	P (1m)	S (3m)	M (5m)
Special length	X06 (6m) ~X10 (10m)		
	X11 (11m) ~X15 (15m)		
	X16 (16m) ~X20 (20m)		
Robot cable	R01 (1m) ~R03 (3m)		
	R04 (4m) ~R05 (5m)		
	R06 (6m) ~R10 (10m)		
	R11 (11m) ~R15 (15m)		
	R16 (16m) ~R20 (20m)		

Options

Name	Option code	Reference page
Brake	B	→P. 11
Cable exit direction (Top)	CJT	→P. 11
Cable exit direction (Outside)	CJO	→P. 11
Cable exit direction (Bottom)	CJB	→P. 11
Motor side-mounted to the left (Standard)	ML	→P. 11
Motor side-mounted to the right	MR	→P. 11
Flange	FL	→P. 12
Non-motor end specification	NM	→P. 11

Actuator Specifications

Item	Description
Drive system	Ball screw Ø20mm (Lead 2.5/10mm), Ø16mm (Lead 5mm), rolled C10
Positioning repeatability	±0.02mm
Lost motion	0.1mm or less
Rod	Ø40mm Aluminum
Rod non-rotation precision (*1)	±0 deg
Allowable load and torque on rod tip	Refer to table in the page on the right, refer to P. 65
Rod tip overhang distance	100mm or less
Ambient operating temperature, humidity	0 to 40°C, 85% RH or less (Non-condensing)

(*1) Rod's angular displacement in rotational direction with no applied load is shown.

Offset distance at end of rod (100mm or less)

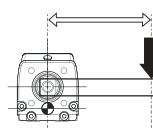

Load at end of rod

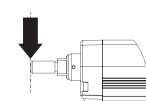

Dimensions

CAD drawings can be downloaded from the website. www.robocylinder.de



- *1 When the rod is returning to its home position, please be careful of interference from surrounding objects, as it will travel until it reaches the ME.
- *2 The direction of width across flats varies depending on the product.
- *3 If the actuator is installed using the front housing and flange, make sure the actuator will not receive any external force.
ME: Mechanical end
SE: Stroke end

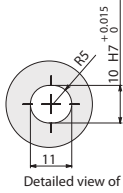
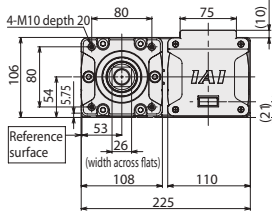
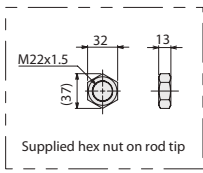

■ Rod Deflection of RCP5-RA10R

(The graph below shows the measurements of how much a horizontally installed rod would deflect when a load is applied to the end of the rod. The measured deflection includes the deflection due to the weight of the rod.)

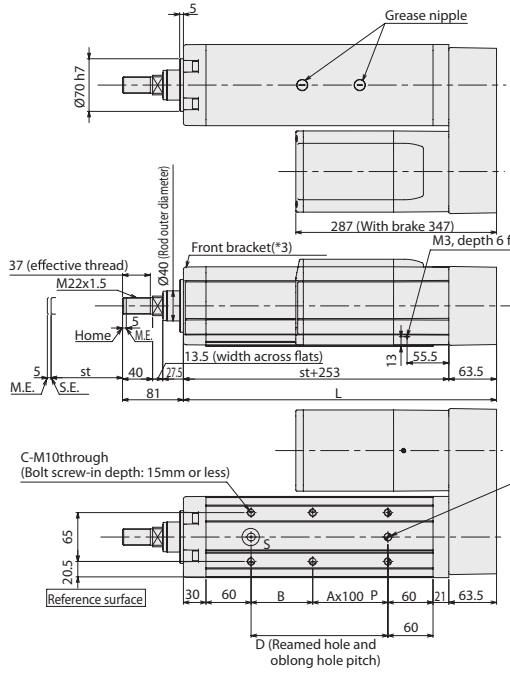
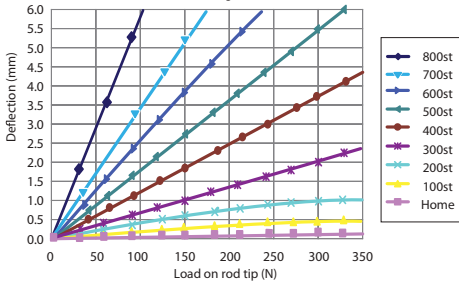

■ Dimensions with Flange (Option)

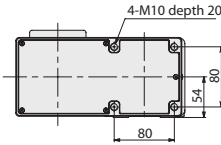
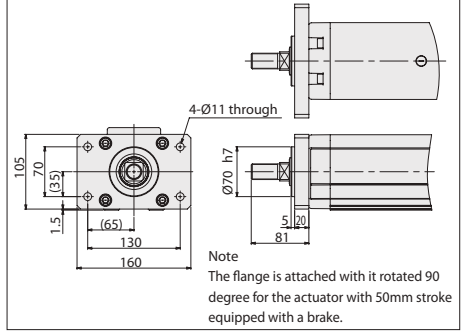

■ 3 Cable Exit Directions (Option)

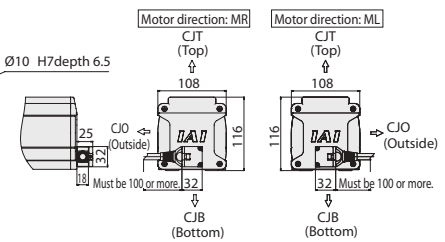

■ Dimensions and Mass by Stroke

Stroke	50	100	150	200	250	300	350	400	450	500	550	600	650	700	750	800
L	366.5	416.5	466.5	516.5	566.5	616.5	666.5	716.5	766.5	816.5	866.5	916.5	966.5	1,016.5	1,066.5	1,116.5
A	0	1	1	2	2	3	3	4	4	5	5	6	6	7	7	8
B	132	82	132	82	132	82	132	82	132	82	132	82	132	82	132	82
C	4	6	6	8	8	10	10	12	12	14	14	16	16	18	18	20
D	132	182	232	282	332	382	432	482	532	582	632	682	732	782	832	882
Allowable static load on rod tip (N)	316.9	268.4	232.6	205.1	183.4	165.7	151.0	138.6	128.1	119.0	111.0	103.9	97.7	92.1	87.0	82.5
	119.1	99.1	84.7	73.8	65.3	58.5	52.8	48.1	44.0	40.5	37.5	34.8	32.4	30.2	28.3	26.5
Allowable dynamic load on rod tip (N)	100.7	85.9	74.9	66.3	59.3	53.6	48.8	44.7	41.2	38.1	35.4	32.9	30.8	28.8	27.0	25.4
	10.1	8.6	7.5	6.6	5.9	5.4	4.9	4.5	4.1	3.8	3.5	3.3	3.1	2.9	2.7	2.5
Allowable static torque on rod tip (N·m)	31.8	27.0	23.4	20.7	18.5	16.8	15.3	14.1	13.1	12.2	11.4	10.7	10.1	9.6	9.1	8.6
	10.1	8.6	7.5	6.6	5.9	5.4	4.9	4.5	4.1	3.8	3.5	3.3	3.1	2.9	2.7	2.5
Mass (kg)	14.6	15.3	16.0	16.7	17.4	18.1	18.8	19.5	20.2	20.9	21.6	22.3	23.0	23.7	24.4	25.1
	16.2	16.9	17.6	18.3	19.0	19.7	20.4	21.1	21.8	22.5	23.2	23.9	24.6	25.3	26.0	26.7

Correlation Diagrams of Vertical Load and Traveling Life

● Since the RCP5-RA10R has a greater maximum thrust than other types, its service life varies significantly depending on the payload and push force applied when the actuator is installed vertically. When selecting an appropriate type from the correlation diagram of speed and payload or correlation diagram of push force and current-limiting value, check its traveling life on the correlation diagram of payload and service life as well as on the correlation diagram of push force and service life.

Note
The rated value represents the maximum value at a traveling life of 5000km. The greatest value is the maximum value at which the actuator can operate.
Take note that, if an actuator is operated beyond its rating, its service life will drop as shown by the applicable graph on the right.

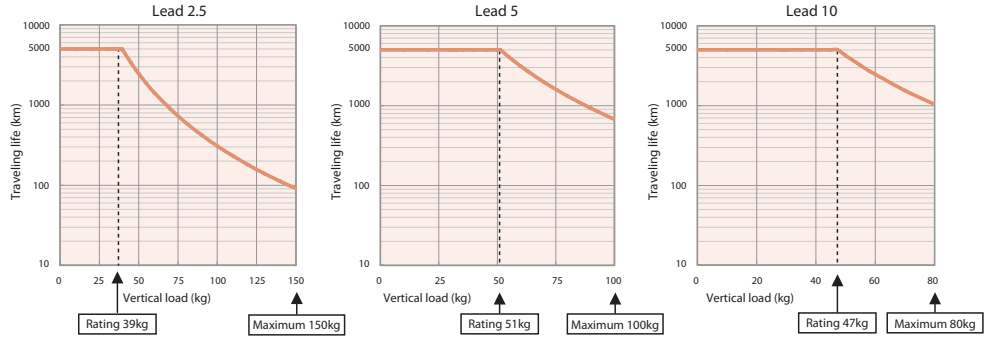

Applicable Controllers

The RCP5 series actuators can be operated by the controllers indicated below. Please select the type depending on your intended use.

Name	External view	Model number	Maximum number of positioning points	Input power	Reference page
Positioner type		PCON-CFA-86PWAI-NP-2-0 PCON-CFA-86PWAI-PN-2-0	512 points	DC24V	→P. 69
Pulse-train type		PCON-CFA-86PWAI-PLN-2-0 PCON-CFA-86PWAI-PLP-2-0	—		
Field network type		PCON-CFA-86PWAI-①-0-0	768 points		

*① Field network specification code (DV, CC, PR, CN, PRT, EC, EP)

RCP5CR-SA4C Cleanroom RoboCylinder, Slider Type, Motor Unit Coupled, Actuator Width 40mm, 24V Pulse Motor

Model	RCP5CR	SA4C	WA	35P				P3		
Specification	Series	Type	Encoder type	Motor type	Lead	Stroke	Stroke	Applicable controllers	Cable length	Options
Items			WA: Battery-less absolute specification	35P: Pulse motor, size 35□	16: 16mm 10: 10mm 5: 5mm 2.5: 2.5mm	50: 50mm 500: 500mm (Every 50mm)		P3: PCON-CA MSEP MSEL	N: No cable P: 1m S: 3m M: 5m X□□: Specified length R□□: Robot cable	Please refer to the options table below.



* Depending on the model, there may be some limitations to using the vertical, side, and ceiling mount positions. Please refer to P.59 for details.



Correlation Diagrams of Speed and Payload

(1) High-output **enabled** with PCON-CA, MSEP, MSEL connected

RCP5CR-SA4C, Horizontal mount

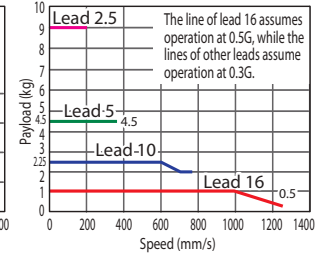
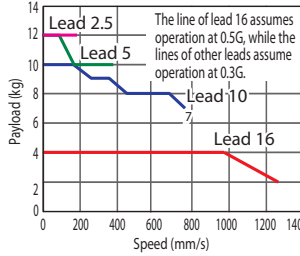

(2) High-output **disabled** with PCON-CA, MSEP connected

RCP5CR-SA4C, Horizontal mount

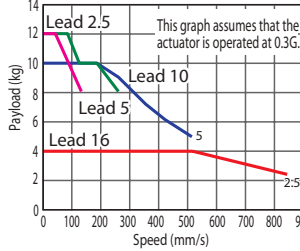

RCP5CR-SA4C, Vertical mount

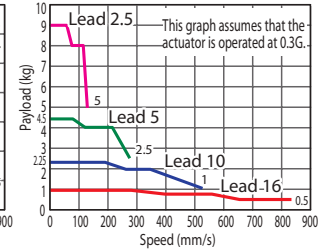

- (1) The actuator specification displays the payload's maximum value, but it will vary depending on the acceleration. Please refer to the "Selection Guidelines" (RCP5 Payload by Speed/Acceleration Table) on P. 61.
- (2) Please refer to P. 59 for push-motion operation.

Actuator Specifications

Lead and Payload

Model number	Lead (mm)	Connected controller	Maximum payload		Stroke (mm)
			Horizontal (kg)	Vertical (kg)	
RCP5CR-SA4C-WA-35P-16-①-P3-②-③	16	High-output enabled	4	1	50~500 (Every 50mm)
		High-output disabled			
RCP5CR-SA4C-WA-35P-10-①-P3-②-③	10	High-output enabled	10	2.25	
		High-output disabled			
RCP5CR-SA4C-WA-35P-5-①-P3-②-③	5	High-output enabled	12	4.5	
		High-output disabled			
RCP5CR-SA4C-WA-35P-2.5-①-P3-②-③	2.5	High-output enabled	12	9	
		High-output disabled			

Legend: ① Stroke ② Cable length ③ Options

Stroke, Max. Speed and Suction Amount

(Unit: mm/s)

Lead (mm)	Connected controller	50~400 (Every 50mm)	450 (mm)	500 (mm)	Suction amount (Nz/min)
16	High-output enabled	1260	1060	875	60
	High-output disabled	840			
10	High-output enabled	785	675	555	40
	High-output disabled	525			
5	High-output enabled	390	330	275	20
	High-output disabled	260			
2.5	High-output enabled	195	165	135	10
	High-output disabled	130			

Cable Length

Type	Cable code
Standard type	P (1m)
	S (3m)
	M (5m)
Special length	X06 (6m) ~X10 (10m)
	X11 (11m) ~X15 (15m)
	X16 (16m) ~X20 (20m)
	R01 (1m) ~R03 (3m)
Robot cable	R04 (4m) ~R05 (5m)
	R06 (6m) ~R10 (10m)
	R11 (11m) ~R15 (15m)
	R16 (16m) ~R20 (20m)

Options

Name	Option code	Reference page
Brake	B	→P. 11
Cable exit direction (Top)	CJT	→P. 11
Cable exit direction (Right)	CJR	→P. 11
Cable exit direction (Left)	CJL	→P. 11
Cable exit direction (Bottom)	CLB	→P. 11
Non-motor end specification	NM	→P. 11
Vacuum joint on opposite side	VR	→P. 11

Actuator Specifications

Item	Description
Drive system	Ball screw Ø8mm, rolled C10
Positioning repeatability	±0.02mm
Lost motion	0.1mm or less
Base	Material: Aluminum with white alumite treatment
Dynamic allowable moment (*1)	Ma: 4.98N·m, Mb: 7.11N·m, Mc: 9.68N·m
Static allowable moment	Ma: 8.6N·m, Mb: 12.2N·m, Mc: 16.7N·m
Cleanliness	ISO class 4 (US FED STD class 10)
Ambient operating temperature, humidity	0 to 40°C, 85% RH or less (Non-condensing)

(*1) Assumes a standard rated life of 5000km.

• Reference for overhang load lengths / Ma: 120mm or less, Mb, Mc: 120mm or less

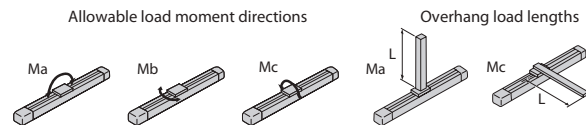

(Note)

The operational life will vary depending on operation and installation conditions. Please refer to the RC General Catalog for details on operational life, allowable moment direction, and overhang load length.

Dimensions

CAD drawings can be downloaded from the website.

www.robocylinder.de



- *1 When the slider is returning to its home position, please be careful of interference from surrounding objects, as it will travel until it reaches the ME.
- ME: Mechanical end
- SE: Stroke end
- *2 There is no pipe joint for RCP5-SA4C Slider Roller Type (SR).

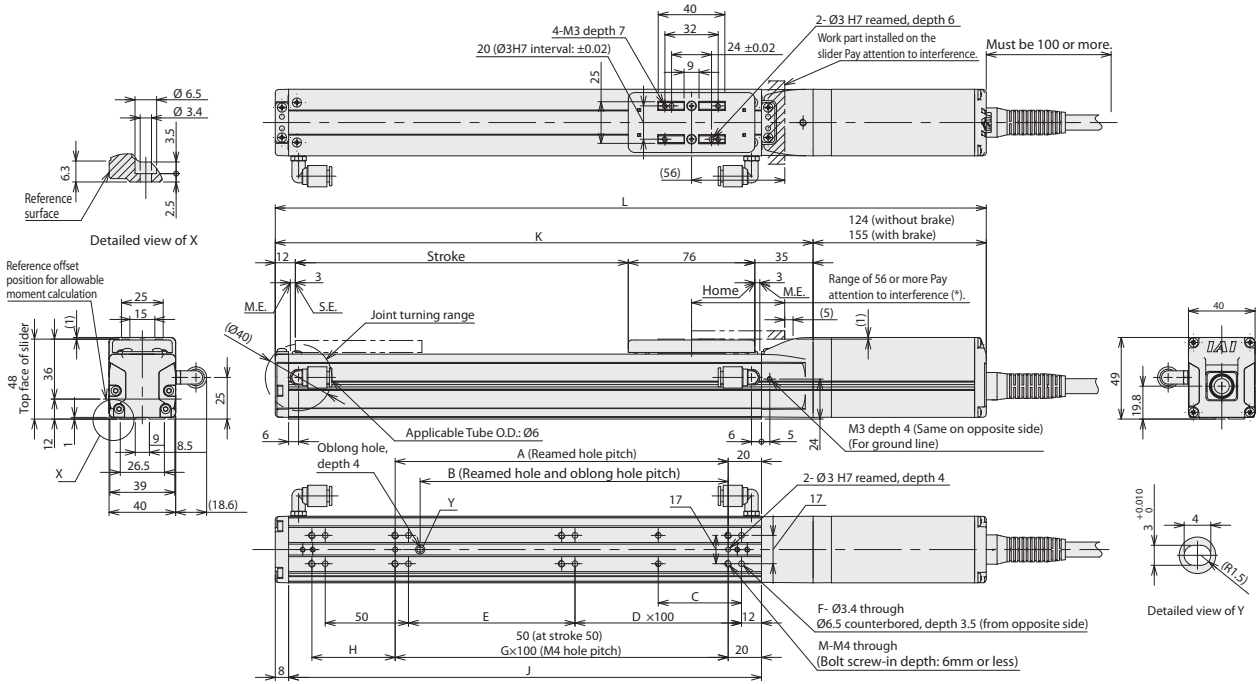

■ Cable Exit Direction (Option)

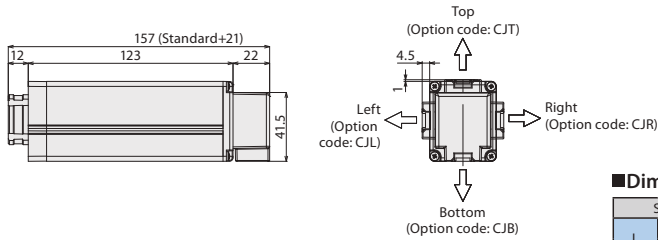

■ Dimensions and Mass by Stroke

Stroke	50	100	150	200	250	300	350	400	450	500
L	Without brake	297	347	397	447	497	547	597	647	697
	With brake	328	378	428	478	528	578	628	678	728
A	50	100	100	200	200	300	300	400	400	500
B	35	85	85	185	185	285	285	385	385	485
C	25	50	50	50	50	50	50	50	50	50
D	0	0	1	1	2	2	3	3	4	4
E	50	100	50	100	50	100	50	100	50	100
F	8	8	10	10	12	12	14	14	16	16
G	0	1	1	2	2	3	3	4	4	5
H	50	50	100	50	100	50	100	50	100	50
J	134	184	234	284	334	384	434	484	534	584
K	173	223	273	323	373	423	473	523	573	623
M	6	6	6	8	8	10	10	12	12	14
Mass (kg)	Without brake	1.0	1.1	1.2	1.3	1.3	1.4	1.5	1.6	1.7
	With brake	1.2	1.3	1.4	1.5	1.5	1.6	1.7	1.8	1.9

Applicable Controllers

The RCP5 series actuators can be operated by the controllers indicated below. Please select the type depending on your intended use.

Name	External view	Model number	Max. number of controlled axes	Maximum number of positioning points	Input power	Reference page
Positioner type (High-output specification)		PCON-CA-35PWAI-①-2-0	1	512 points	DC24V	→P. 69
Pulse train type (High-output specification)		PCON-CA-35PWAI-PL②-2-0				
Field network type (High-output specification)		PCON-CA-35PWAI-③-0-0				
Solenoid valve multi-axis type (PIO specification)		MSEP-④-⑤---①-2-0	C: 8 (4 when high-output enabled) LC: 6 (3 when high-output enabled)	3 points	Single-phase AC 100V~230V	→P. 77
Positioner multi-axis type (Field network specification)		MSEP-④-⑤---③-0-0				
Program control multi-axis safety category type		MSEL-PG-1-35PWAI-①-2-4	4	30000 points	Single-phase AC 100V~230V	→P. 87
Program control multi-axis safety category type (w/ network board)		MSEL-PG-1-35PWAI-③-0-4				

*Above MSEL models are for single-axis specification *① I/O type (NP/PN) *② Number of axes
 *③ Field network specification code *④ N (NPN specification) or P (PNP specification) code
 *The high output enabled operation is only available when the "High-output setting specs" is selected in the MSEP-C/LC.

RCP5CR-SA6C

Cleanroom RoboCylinder, Slider Type, Motor Unit Coupled, Actuator Width 58mm, 24V Pulse Motor

Model	RCP5CR	SA6C	WA	42P				P3		
Specification	Series	Type	Encoder type	Motor type	Lead	Stroke		Applicable controllers	Cable length	Options
Items			WA: Battery-less absolute specification	42P: Pulse motor, size 42□	20: 20mm 12: 12mm 6: 6mm 3: 3mm	50: 50mm 800: 800mm (Every 50mm)		P3: PCON-CA MSEP MSEL	N: No cable P: 1m S: 3m M: 5m X□□: Specified length R□□: Robot cable	Please refer to the options table below.



* Depending on the model, there may be some limitations to using the vertical, side, and ceiling mount positions. Please refer to P.59 for details.



Correlation Diagrams of Speed and Payload

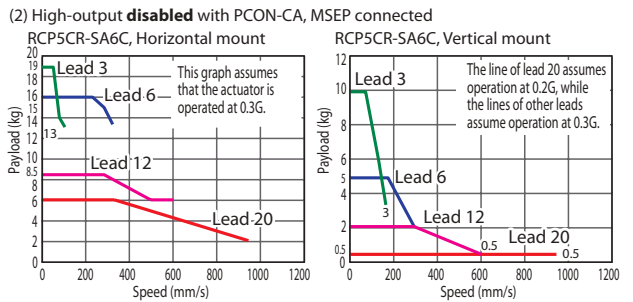
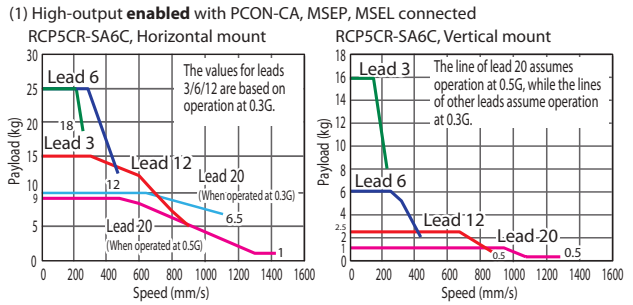

POINT
Note on selection

(1) The actuator specification displays the payload's maximum value, but it will vary depending on the acceleration. Please refer to the "Selection Guidelines" (RCP5 Payload by Speed/Acceleration Table) on P. 61.

(2) Please refer to P. 59 for push-motion operation.

Actuator Specifications

Lead and Payload

Model number	Lead (mm)	Connected controller	Maximum payload		Stroke (mm)
			Horizontal (kg)	Vertical (kg)	
RCP5CR-SA6C-WA-42P-20-①-P3-②-③	20	High-output enabled	10	1	50~800 (Every 50mm)
		High-output disabled	6	0.5	
RCP5CR-SA6C-WA-42P-12-①-P3-②-③	12	High-output enabled	15	2.5	
		High-output disabled	8.5	2	
RCP5CR-SA6C-WA-42P-6-①-P3-②-③	6	High-output enabled	25	6	
		High-output disabled	16	5	
RCP5CR-SA6C-WA-42P-3-①-P3-②-③	3	High-output enabled	25	16	
		High-output disabled	19	10	

Legend: ① Stroke ② Cable length ③ Options

Stroke, Max. Speed and Suction Amount

(Unit: mm/s)

Lead (mm)	Connected controller	50~400 (Every 50mm)	450 (mm)	500 (mm)	550 (mm)	600 (mm)	650 (mm)	700 (mm)	750 (mm)	800 (mm)	Suction amount (NE/min)
20	High-output enabled	1,440 (<1280>)	1,335 (<1280>)	1,130	970	840	735	650	575	100	
	High-output disabled	960						840	735		650
12	High-output enabled	900	885	735	620	535	460	405	355	70	
	High-output disabled	600				535	460	405	355		315
6	High-output enabled	450	435	365	305	265	230	200	175	30	
	High-output disabled	300			265	230	200	175	155		
3	High-output enabled	225	215	180	150	130	115	100	85	15	
	High-output disabled	150		130	115	100	85	75			

Values in brackets < > are for vertical use.

Cable Length

Type	Cable code
Standard type	P (1m)
	S (3m)
	M (5m)
Special length	X06 (6m) ~X10 (10m)
	X11 (11m)~X15 (15m)
	X16 (16m)~X20 (20m)
Robot cable	R01 (1m) ~R03 (3m)
	R04 (4m) ~R05 (5m)
	R06 (6m) ~R10 (10m)
	R11 (11m)~R15 (15m)
	R16 (16m)~R20 (20m)

Options

Name	Option code	Reference page
Brake	B	→P. 11
Cable exit direction (Top)	CJT	→P. 11
Cable exit direction (Right)	CJR	→P. 11
Cable exit direction (Left)	CJL	→P. 11
Cable exit direction (Bottom)	CLB	→P. 11
Non-motor end specification	NM	→P. 11
Vacuum joint on opposite side	VR	→P. 11

Actuator Specifications

Item	Description
Drive system	Ball screw Ø10mm, rolled C10
Positioning repeatability (*1)	±0.02mm [±0.03mm]
Lost motion	0.1mm or less
Base	Material: Aluminum with white alumite treatment
Dynamic allowable moment (*2)	Ma: 11.6N·m, Mb: 16.6N·m, Mc: 24.6N·m
Static allowable moment	Ma: 38.3N·m, Mb: 54.7N·m, Mc: 81N·m
Cleanliness	ISO class 4 (US FED STD class 10)
Ambient operating temperature, humidity	0 to 40°C, 85% RH or less (Non-condensing)

(*1) The values in brackets [] are for Lead 20.

(*2) Assumes a standard rated life of 5000km.

• Reference for overhang load lengths / Ma: 150mm or less, Mb, Mc: 150mm or less

Allowable load moment directions

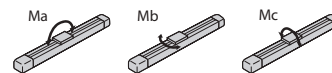

Overhang load lengths

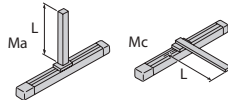

(Note)

The operational life will vary depending on operation and installation conditions. Please refer to the RC General Catalog for details on operational life, allowable moment direction, and overhang load length.

Dimensions

CAD drawings can be downloaded from the website.

www.robocylinder.de



- *1 When the slider is returning to its home position, please be careful of interference from surrounding objects, as it will travel until it reaches the ME.
- ME: Mechanical end
- SE: Stroke end
- *2 There is no pipe joint for RCP5-SA6C Slider Roller Type (SR).

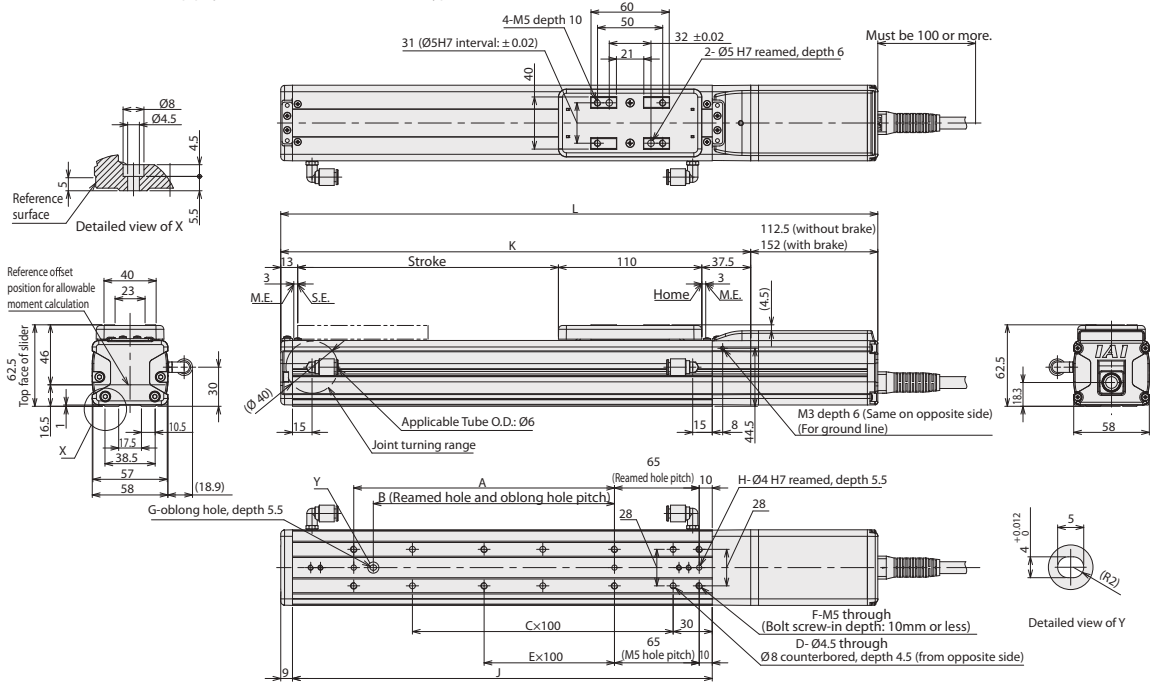

Cable Exit Direction (Option)

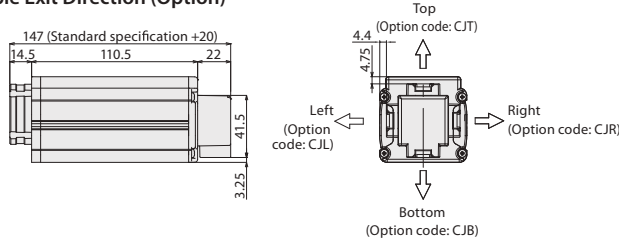

Dimensions and Mass by Stroke

Stroke	50	100	150	200	250	300	350	400	450	500	550	600	650	700	750	800	
L	Without brake	323	373	423	473	523	573	623	673	723	773	823	873	923	973	1023	1073
	With brake	362.5	412.5	462.5	512.5	562.5	612.5	662.5	712.5	762.5	812.5	862.5	912.5	962.5	1012.5	1062.5	1112.5
A	0	100	100	200	200	300	300	400	400	500	500	600	600	700	700	800	800
B	0	85	85	185	185	285	285	385	385	485	485	585	585	685	685	785	785
C	1	1	2	2	3	3	4	4	5	5	6	6	7	7	8	8	8
D	4	4	6	6	8	8	10	10	12	12	14	14	16	16	18	18	18
E	0	0	0	1	1	2	2	3	3	4	4	5	5	6	6	7	7
F	4	6	6	8	8	10	10	12	12	14	14	16	16	18	18	20	20
G	0	1	1	1	1	1	1	1	1	1	1	1	1	1	1	1	1
H	2	3	3	3	3	3	3	3	3	3	3	3	3	3	3	3	3
J	172	222	272	322	372	422	472	522	572	622	672	722	772	822	872	922	922
K	210.5	260.5	310.5	360.5	410.5	460.5	510.5	560.5	610.5	660.5	710.5	760.5	810.5	860.5	910.5	960.5	960.5
Mass (kg)	Without brake	1.7	1.8	2.0	2.2	2.4	2.5	2.7	2.9	3.1	3.2	3.4	3.6	3.8	3.9	4.1	4.3
	With brake	1.9	2.0	2.2	2.4	2.6	2.7	2.9	3.1	3.3	3.4	3.6	3.8	4.0	4.1	4.3	4.5

Applicable Controllers

The RCP5 series actuators can be operated by the controllers indicated below. Please select the type depending on your intended use.

Name	External view	Model number	Max. number of controlled axes	Maximum number of positioning points	Input power	Reference page
Positioner type (High-output specification)		PCON-CA-42PWAI-①-2-0	1	512 points	DC24V	→P. 69
Pulse train type (High-output specification)		PCON-CA-42PWAI-PL-②-2-0				
Field network type (High-output specification)		PCON-CA-42PWAI-③-0-0				
Solenoid valve multi-axis type (PIO specification)		MSEP-④-①-①-①-2-0	C: 8 (4 when high-output enabled) LC: 6 (3 when high-output enabled)	3 points	DC24V	→P. 77
Positioner multi-axis type (Field network specification)		MSEP-④-①-①-①-0-0				
Program control multi-axis safety category type		MSEL-PG-1-42PWAI-①-2-4	4	30000 points	Single-phase AC 100V~230V	→P. 87
Program control multi-axis safety category type (w/ network board)		MSEL-PG-1-42PWAI-③-0-4				

*Above MSEL models are for single-axis specification *① I/O type (NP/PN) *③ Number of axes
 *② Field network specification code *④ C or LC *④ N (NPN specification) or P (PNP specification) code
 *The high output enabled operation is only available when the "High-output setting specs" is selected in the MSEP-C/LC.

RCP5CR-SA7C Cleanroom RoboCylinder, Slider Type, Motor Unit Coupled, Actuator Width 73mm, 24V Pulse Motor

Model	RCP5CR	SA7C	WA	56P			P3		
Specification	Series	Type	Encoder type	Motor type	Lead	Stroke	Applicable controllers	Cable length	Options
Items			WA: Battery-less absolute specification	56P: Pulse motor, size 56□	24: 24mm 16: 16mm 8: 8mm 4: 4mm	50: 50mm 800: 800mm (Every 50mm)	P3: PCON-CA MSEP MSEL	N: No cable P: 1m S: 3m M: 5m X□: Specified length R□: Robot cable	Please refer to the options table below.

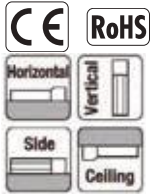

* Depending on the model, there may be some limitations to using the vertical, side, and ceiling mount positions. Please refer to P.59 for details.

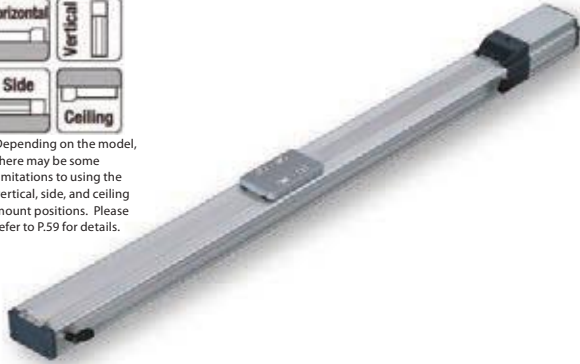

Correlation Diagrams of Speed and Payload

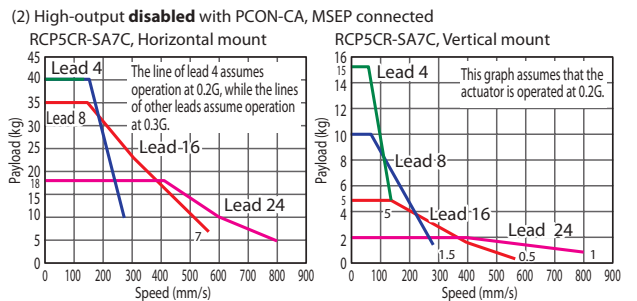
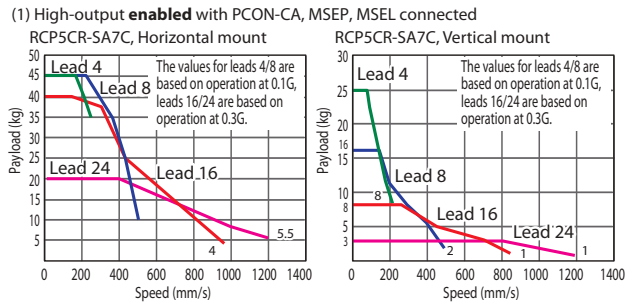

- (1) The actuator specification displays the payload's maximum value, but it will vary depending on the acceleration. Please refer to the "Selection Guidelines" (RCP5 Payload by Speed/Acceleration Table) on P. 61.
- (2) Please refer to P. 59 for push-motion operation.

Actuator Specifications

Lead and Payload

Model number	Lead (mm)	Connected controller	Maximum payload		Stroke (mm)
			Horizontal (kg)	Vertical (kg)	
RCP5CR-SA7C-WA-56P-24-①-P3-②-③	24	High-output enabled	20	3	50~800 (Every 50mm)
		High-output disabled	18	2	
RCP5CR-SA7C-WA-56P-16-①-P3-②-③	16	High-output enabled	40	8	
		High-output disabled	35	5	
RCP5CR-SA7C-WA-56P-8-①-P3-②-③	8	High-output enabled	45	16	
		High-output disabled	40	10	
RCP5CR-SA7C-WA-56P-4-①-P3-②-③	4	High-output enabled	45	25	
		High-output disabled	40	15	

Legend: ① Stroke ② Cable length ③ Options

Stroke, Max. Speed and Suction Amount

(Unit: mm/s)

Lead (mm)	Connected controller	Stroke (mm)						Suction amount (Nz/min)
		50~550 (Every 50mm)	600 (mm)	650 (mm)	700 (mm)	750 (mm)	800 (mm)	
24	High-output enabled	1200		1145	1000	885	785	90
	High-output disabled			800			785	
16	High-output enabled	980 <840>	875 <840>	755	660	585	520	70
	High-output disabled			560			520	
8	High-output enabled	490	430	375	325	290	255	40
	High-output disabled			280			255	
4	High-output enabled	245 <210>	215 <210>	185	160	140	125	30
	High-output disabled			140			125	

Values in brackets < > are for vertical use.

Cable Length

Type	Cable code
Standard type	P (1m)
	S (3m)
	M (5m)
Special length	X06 (6m) ~X10 (10m)
	X11 (11m)~X15 (15m)
	X16 (16m)~X20 (20m)
Robot cable	R01 (1m) ~R03 (3m)
	R04 (4m) ~R05 (5m)
	R06 (6m) ~R10 (10m)
	R11 (11m)~R15 (15m)
	R16 (16m)~R20 (20m)

Options

Name	Option code	Reference page
Brake	B	→P. 11
Cable exit direction (Top)	CJT	→P. 11
Cable exit direction (Right)	CJR	→P. 11
Cable exit direction (Left)	CJL	→P. 11
Cable exit direction (Bottom)	CLB	→P. 11
Non-motor end specification	NM	→P. 11
Vacuum joint on opposite side	VR	→P. 11

Actuator Specifications

Item	Description
Drive system	Ball screw Ø12mm, rolled C10
Positioning repeatability (*1)	±0.02mm [±0.03mm]
Lost motion	0.1mm or less
Base	Material: Aluminum with white alumite treatment
Dynamic allowable moment (*2)	Ma: 11.6N·m, Mb: 16.6N·m, Mc: 33.7N·m
Static allowable moment	Ma: 51.2N·m, Mb: 73.1N·m, Mc: 148N·m
Cleanliness	ISO class 4 (US FED STD class 10)
Ambient operating temperature, humidity	0 to 40°C, 85% RH or less (Non-condensing)

(*1) The values in brackets [] are for Lead 24.

(*2) Assumes a standard rated life of 5000km.

• Reference for overhang load lengths / Ma: 230mm or less, Mb, Mc: 230mm or less

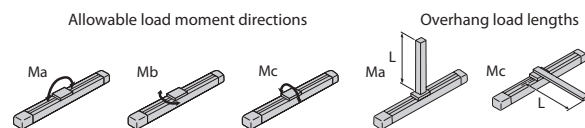

(Note)

The operational life will vary depending on operation and installation conditions. Please refer to the RC General Catalog for details on operational life, allowable moment direction, and overhang load length.

Dimensions

CAD drawings can be downloaded from the website.

www.robocylinder.de

2/3D CAD

- *1 When the slider is returning to its home position, please be careful of interference from surrounding objects, as it will travel until it reaches the ME.
- ME: Mechanical end
- SE: Stroke end
- *2 There is no pipe joint for RCP5-SA7C Slider Roller Type (SR).

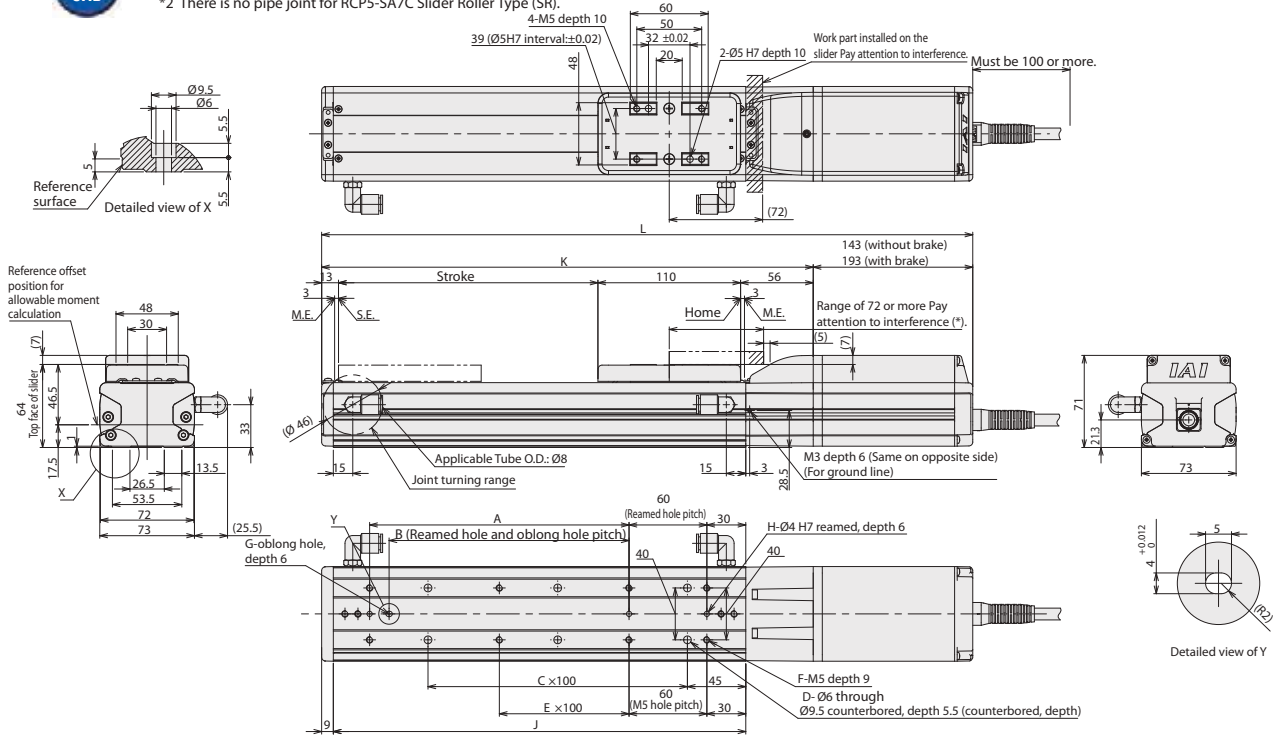

Cable Exit Direction (Option)

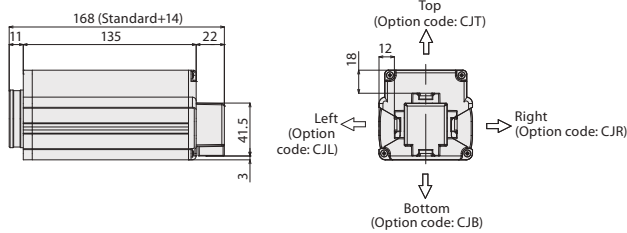

Dimensions and Mass by Stroke

Stroke	50	100	150	200	250	300	350	400	450	500	550	600	650	700	750	800
L	Without brake	372	422	472	522	572	622	672	722	772	822	872	922	1022	1072	1122
	With brake	422	472	522	572	622	672	722	772	822	872	922	972	1022	1072	1122
A	0	100	100	200	200	300	300	400	400	500	500	600	600	700	700	800
B	0	85	85	185	185	285	285	385	385	485	485	585	585	685	685	785
C	1	1	2	2	3	3	4	4	5	5	6	6	7	7	8	8
D	4	4	6	6	8	8	10	10	12	12	14	14	16	16	18	18
E	0	0	0	1	1	2	2	3	3	4	4	5	5	6	6	7
F	4	6	6	8	8	10	10	12	12	14	14	16	16	18	18	20
G	0	1	1	1	1	1	1	1	1	1	1	1	1	1	1	1
H	2	3	3	3	3	3	3	3	3	3	3	3	3	3	3	3
J	168	218	268	318	368	418	468	518	568	618	668	718	768	818	868	918
K	229	279	329	379	429	479	529	579	629	679	729	779	829	879	929	979
Mass (kg)	Without brake	3.0	3.2	3.5	3.7	3.9	4.1	4.4	4.6	4.8	5.0	5.3	5.5	5.7	5.9	6.1
	With brake	3.5	3.7	4.0	4.2	4.4	4.6	4.9	5.1	5.3	5.5	5.8	6.0	6.2	6.4	6.6

Applicable Controllers

The RCP5 series actuators can be operated by the controllers indicated below. Please select the type depending on your intended use.

Name	External view	Model number	Max. number of controlled axes	Maximum number of positioning points	Input power	Reference page
Positioner type (High-output specification)		PCON-CA-56PWAI-①-2-0	1	512 points	DC24V	→P. 69
Pulse train type (High-output specification)		PCON-CA-56PWAI-PL②-2-0				
Field network type (High-output specification)		PCON-CA-56PWAI-③-0-0				
Solenoid valve multi-axis type (PIO specification)		MSEP-④-⑤-⑥-⑦-⑧-⑨-⑩-2-0	C: 8 (4 when high-output enabled) LC: 6 (3 when high-output enabled)	3 points	DC24V	→P. 77
Positioner multi-axis type (Field network specification)		MSEP-④-⑤-⑥-⑦-⑧-⑨-⑩-0-0				
Program control multi-axis safety category type		MSEL-PG-1-56PWAI-①-2-4	4	30000 points	Single-phase AC 100V~230V	→P. 87
Program control multi-axis safety category type (w/ network board)		MSEL-PG-1-56PWAI-③-0-4				

*Above MSEL models are for single-axis specification *① I/O type (NP/PN) *② Number of axes
 *③ Field network specification code *④ C or LC *⑤ V (NPN specification) or P (PNP specification) code
 *The high output enabled operation is only available when the "High-output setting specs" is selected in the MSEP-C/LC.

RCP5-BA4/BA4U RoboCylinder, Belt Type, Actuator Width 40mm, Pulse Motor, Top-mounted Motor/Bottom-mounted Motor

Model	RCP5	WA	35P	48	P3				
Specification	Series	Type	Encoder type	Motor type	Lead	Stroke	Applicable controllers	Cable length	Options
Items	BA4: Belt type Top-mounted motor BA4U: Belt type Bottom-mounted motor	WA: Battery-less absolute specification	35P: Pulse motor, size 35□	48: Equiv. to 48mm	300: 300mm 1200: 1200mm (Every 100mm)	P3: PCON-CA MSEP MSEL	N: No cable P: 1m S: 3m M: 5m X□□: Specified length R□□: Robot cable	Please refer to the options table below.	



* Depending on the model, there may be some limitations to using the side and ceiling mount positions. Please refer to P.59 for details.

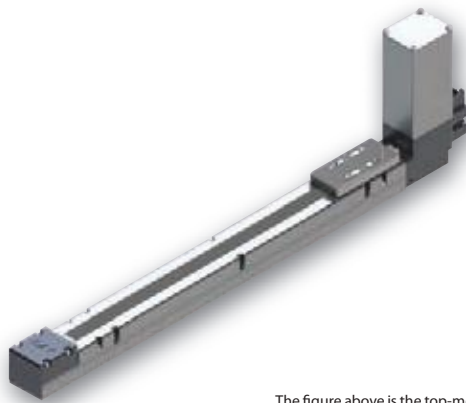

The figure above is the top-mounted motor type.

Correlation Diagram of Speed and Payload (when high-output setting of controller is enabled)

Due to a pulse motor used for RCP5 series, its payload gets lower when operated at higher speed. Please refer to this diagram below to make sure that the required payload will be met at the operation speed you desire.

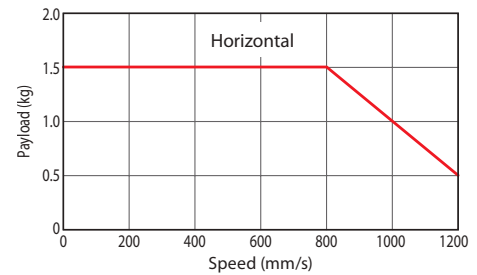

- POINT**
Note on selection
- Please set the operation speed at 150mm/s or higher for the belt type as it may cause vibration or noise when used at lower speed.
 - Due to a pulse motor used for RCP5 series, its payload gets lower when operated at higher speed. Please refer to the correlation diagram of speed and payload on this page or to the selection table on P. 65 to make sure that the required payload will be met at the operation speed you desire.
 - The payload assumes operation at an acceleration of 0.5G. 0.5G is the upper limit of the acceleration.
 - Push-motion operation cannot be performed.

Warnings

- This model cannot be installed in the vertical mount position.
- Horizontal and ceiling mount specifications cannot be installed in the side position. Similarly, side mount specification cannot be installed in a horizontal or ceiling mount position.
- The maximum stroke for the side and ceiling mount positions is 1000mm.

Actuator Specifications

Lead and Payload

Model number	Motor attached side	Lead (mm)	Maximum payload		Stroke (mm)
			Horizontal (kg)		
RCP5-BA4-WA-35P-48-①-P3-②-③	Top	Equiv. to 48mm	1.5		300~1200 (Every 100mm)
RCP5-BA4U-WA-35P-48-①-P3-②-③	Bottom				

Legend: ① Stroke ② Cable length ③ Options

Stroke and Maximum Speed

(Unit: mm/s)

Lead (mm)	300 (mm)	400 (mm)	500 (mm)	600 (mm)	700~1200 (Every 100mm)
Equiv. to 48mm	890	1040	1120	1160	1200

The values apply to high-output setting of controller.

Cable Length

Type	Cable code
Standard type	P (1m)
	S (3m)
	M (5m)
Special length	X06 (6m) ~X10 (10m)
	X11 (11m) ~X15 (15m)
	X16 (16m) ~X20 (20m)
	R01 (1m) ~R03 (3m)
Robot cable	R04 (4m) ~R05 (5m)
	R06 (6m) ~R10 (10m)
	R11 (11m) ~R15 (15m)
	R16 (16m) ~R20 (20m)

Options

Name	Option code	Reference page
Brake	B	→P. 11
Cable exit direction (Top)	CJT	→P. 11
Cable exit direction (Right)	CJR	→P. 11
Cable exit direction (Left)	CJL	→P. 11
Cable exit direction (Bottom)	CJB	→P. 11
Ceiling mount type	CIM	→P. 59
Left side-mount type	SIL	→P. 59
Right side-mount type	SIR	→P. 59
Non-motor end specification	NM	→P. 11

Actuator Specifications

Item	Description
Drive system	Timing belt
Positioning repeatability	±0.08mm
Lost motion	0.1mm or less
Base	Material: Aluminum with white alumite treatment
Dynamic allowable moment (*1)	Ma: 6.14N·m, Mb: 6.14N·m, Mc: 11.9N·m
Static allowable moment	Ma: 16N·m, Mb: 16N·m, Mc: 31.2N·m
Ambient operating temperature, humidity	0 to 40°C, 85% RH or less (Non-condensing)

(*1) Assumes a standard rated life of 5000km.

* Reference for overhang load lengths / Ma: 120mm or less, Mb, Mc: 120mm or less

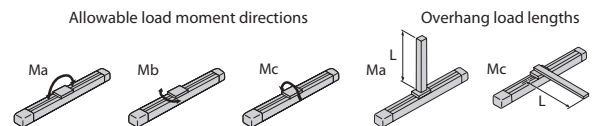

(Note)

The operational life will vary depending on operation and installation conditions. Please refer to the RC General Catalog for details on operational life, allowable moment direction, and overhang load length.



*1 When the slider is returning to its home position, please be careful of interference from surrounding objects, as it will travel until it reaches the ME.
ME: Mechanical end
SE: Stroke end

*The way to attach the actuator is to fix with screws from the top only.

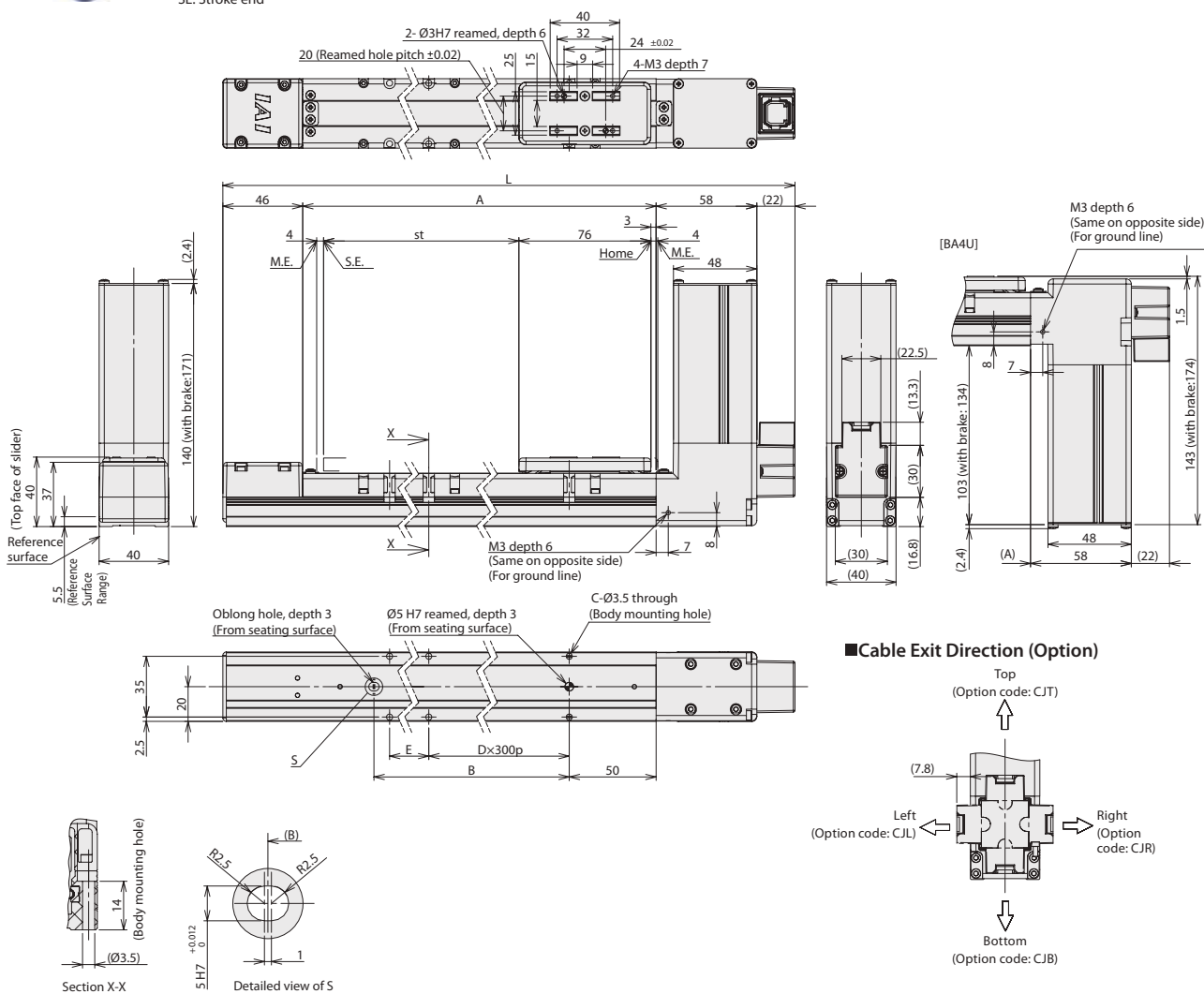

■ Cable Exit Direction (Option)

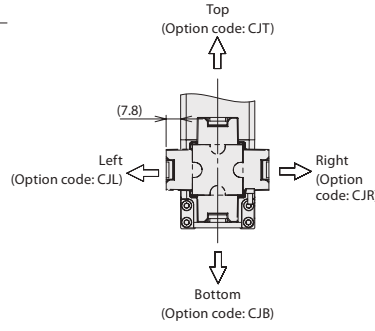

■ Dimensions and Mass by Stroke

Stroke	300	400	500	600	700	800	900	1000	1100	1200
L	517	617	717	817	917	1017	1117	1217	1317	1417
A	391	491	591	691	791	891	991	1091	1191	1291
B	300	400	500	600	700	800	900	1000	1100	1200
C	4	6	6	6	8	8	8	10	10	10
D	0	1	1	1	2	2	2	3	3	3
E	291	91	191	291	91	191	291	91	191	291
Mass (kg)										
Without brake	1.7	1.8	2	2.1	2.3	2.4	2.5	2.7	2.8	2.9
With brake	1.9	2	2.2	2.3	2.5	2.6	2.7	2.9	3	3.1

*The weights shown in the table above are for BA4. The weight increases by 0.2kg for BA4U.

Applicable Controllers

The RCP5 series actuators can be operated by the controllers indicated below. Please select the type depending on your intended use.

Name	External view	Model number	Max. number of controlled axes	Maximum number of positioning points	Input power	Reference page
Positioner type (High-output specification)		PCON-CA-35PWAI-①-2-0	1	512 points	DC24V	→P. 69
Pulse train type (High-output specification)		PCON-CA-35PWAI-PL-②-2-0				
Field network type (High-output specification)		PCON-CA-35PWAI-③-0-0				
Solenoid valve multi-axis type (PIO specification)		MSEP-④-⑤-⑥-⑦-⑧-⑨-⑩-2-0	C: 8 (4 when high-output enabled) LC: 6 (3 when high-output enabled)	3 points		→P. 77
Positioner multi-axis type (Field network specification)		MSEP-④-⑤-⑥-⑦-⑧-⑨-⑩-0-0				
Program control multi-axis safety category type		MSEL-PG-1-35PWAI-⑪-2-4	4	30000 points	Single-phase AC 100V~230V	→P. 87
Program control multi-axis safety category type (w/ network board)		MSEL-PG-1-35PWAI-⑫-0-4				

*Above MSEL models are for single-axis specification *① I/O type (NP/PN) *⑩ Number of axes
 *② Field network specification code *③ C or LC *④ N (NPN specification) or P (PNP specification) code
 *The high output enabled operation is only available when the "High-output setting specs" is selected in the MSEP-C/LC.

RCP5-BA6/BA6U RoboCylinder, Belt Type, Actuator Width 58mm, Pulse Motor, Top-mounted Motor/Bottom-mounted Motor

Model	RCP5	WA	42P	48		P3			
Specification	Series	Type	Encoder type	Motor type	Lead	Stroke	Applicable controllers	Cable length	Options
Items	BA6: Belt type Top-mounted motor BA6U: Belt type Bottom-mounted motor	WA: Battery-less absolute specification	42P: Pulse motor, size 42□	48: Equiv. to 48mm	300: 300mm 2200: 2200mm (Every 100mm)	P3: PCON-CA MSEP MSEL	N: No cable P: 1m S: 3m M: 5m X□: Specified length R□: Robot cable	Please refer to the options table below.	



* Depending on the model, there may be some limitations to using the side and ceiling mount positions. Please refer to



The figure above is the top-mounted motor type.

Correlation Diagram of Speed and Payload (when high-output setting of controller is enabled)

Due to a pulse motor used for RCP5 series, its payload gets lower when operated at higher speed. Please refer to this diagram below to make sure that the required payload will be met at the operation speed you desire.

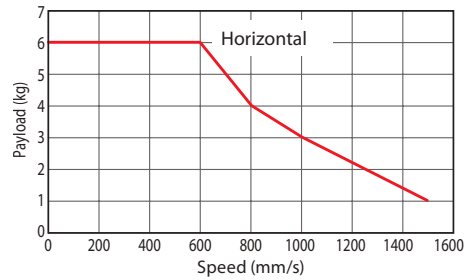

- Please set the operation speed at 100mm/s or higher for the belt type as it may cause vibration or noise when used at lower speed.
- Due to a pulse motor used for RCP5 series, its payload gets lower when operated at higher speed. Please refer to the correlation diagram of speed and payload on this page or to the selection table on P. 65 to make sure that the required payload will be met at the operation speed you desire.
- The payload assumes operation at an acceleration of 0.5G. 0.5G is the upper limit of the acceleration.
- Push-motion operation cannot be performed.

Warnings

- This model cannot be installed in the vertical mount position.
- Horizontal and ceiling mount specifications cannot be installed in the side position. Similarly, side mount specification cannot be installed in a horizontal or ceiling mount position.
- The maximum stroke for the side and ceiling mount positions is 1000mm.

Actuator Specifications

Lead and Payload

Model number	Motor attached side	Lead (mm)	Maximum payload		Stroke (mm)
			Horizontal (kg)		
RCP5-BA6-WA-42P-48-①-P3-②-③	Top	Equiv. to 48mm	6		300~2200 (Every 100mm)
RCP5-BA6U-WA-42P-48-①-P3-②-③	Bottom				

Legend: ① Stroke ② Cable length ③ Options

Stroke and Maximum Speed

(Unit: mm/s)

Lead (mm)	300 (mm)	400 (mm)	500 (mm)	600 (mm)	700 (mm)	800 (mm)	900~2,200 (Every 100mm)
Equiv. to 48mm	890	1070	1220	1340	1400	1440	1500

The values apply to high-output setting of controller.

Cable Length

Type	Cable code
Standard type	P (1m)
	S (3m)
	M (5m)
Special length	X06 (6m) ~X10 (10m)
	X11 (11m) ~X15 (15m)
	X16 (16m) ~X20 (20m)
	R01 (1m) ~R03 (3m)
Robot cable	R04 (4m) ~R05 (5m)
	R06 (6m) ~R10 (10m)
	R11 (11m) ~R15 (15m)
	R16 (16m) ~R20 (20m)

Actuator Specifications

Item	Description
Drive system	Timing belt
Positioning repeatability	±0.08mm
Lost motion	0.1mm or less
Base	Material: Aluminum with white alumite treatment
Dynamic allowable moment (*1)	Ma: 15.7N·m, Mb: 15.7N·m, Mc: 31.6N·m
Static allowable moment	Ma: 44.5N·m, Mb: 44.5N·m, Mc: 89.2N·m
Ambient operating temperature, humidity	0 to 40°C, 85% RH or less (Non-condensing)

(*1) Assumes a standard rated life of 5000km.

• Reference for overhang load lengths / Ma: 150mm or less, Mb, Mc: 150mm or less

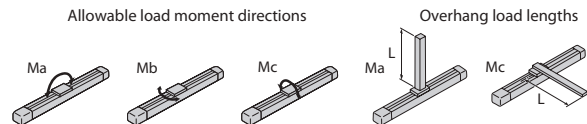

(Note)

The operational life will vary depending on operation and installation conditions. Please refer to the RC General Catalog for details on operational life, allowable moment direction, and overhang load length.

Options		
Name	Option code	Reference page
Brake	B	→P. 11
Cable exit direction (Top)	CJT	→P. 11
Cable exit direction (Right)	CJR	→P. 11
Cable exit direction (Left)	CJL	→P. 11
Cable exit direction (Bottom)	CJB	→P. 11
Ceiling mount type	CIM	→P. 59
Left side-mount type	SIL	→P. 59
Right side-mount type	SIR	→P. 59
Non-motor end specification	NM	→P. 11



*1 When the slider is returning to its home position, please be careful of interference from surrounding objects, as it will travel until it reaches the ME.
ME: Mechanical end
SE: Stroke end

*The way to attach the actuator is to fix with screws from the top only.

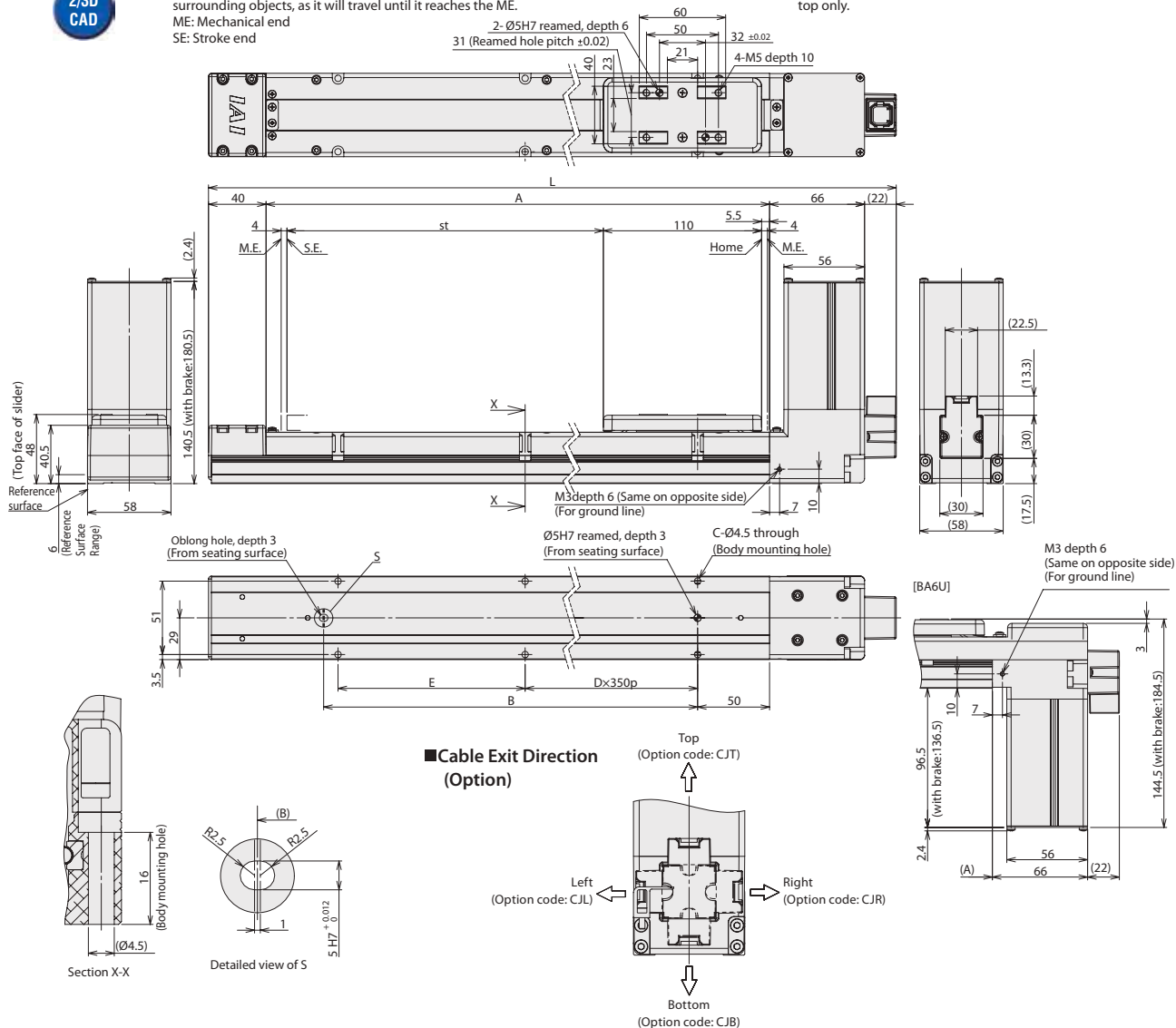

■ Dimensions and Mass by Stroke

Stroke	300	400	500	600	700	800	900	1000	1100	1200	1300	1400	1500	1600	1700	1800	1900	2000	2100	2200	
L	558	658	758	858	958	1058	1158	1258	1358	1458	1558	1658	1758	1858	1958	2058	2158	2258	2358	2458	
A	430	530	630	730	830	930	1030	1130	1230	1330	1430	1530	1630	1730	1830	1930	2030	2130	2230	2330	
B	340	440	540	640	740	840	940	1040	1140	1240	1340	1440	1540	1640	1740	1840	1940	2040	2140	2240	
C	4	6	6	6	6	8	8	8	10	10	10	10	12	12	12	14	14	14	14	14	
D	0	1	1	1	1	2	2	3	3	3	3	4	4	4	4	5	5	5	5	6	
E	330	80	180	280	380	130	230	330	80	180	280	380	130	230	330	80	180	280	380	130	
Mass (kg)	Without brake	2.2	2.4	2.7	2.9	3.1	3.3	3.5	3.7	3.9	4.2	4.4	4.6	4.8	5	5.2	5.4	5.6	5.9	6.1	6.3
	With brake	2.6	2.8	3.1	3.3	3.5	3.7	3.9	4.1	4.3	4.6	4.8	5	5.2	5.4	5.6	5.8	6	6.3	6.5	6.7

*The weights shown in the table above are for BA6. The weight increases by 0.2kg for BA6U.

Applicable Controllers

The RCP5 series actuators can be operated by the controllers indicated below. Please select the type depending on your intended use.

Name	External view	Model number	Max. number of controlled axes	Maximum number of positioning points	Input power	Reference page
Positioner type (High-output specification)		PCON-CA-42PWAI-①-2-0	1	512 points	DC24V	→P. 69
Pulse train type (High-output specification)		PCON-CA-42PWAI-PL-②-2-0				
Field network type (High-output specification)		PCON-CA-42PWAI-③-0-0				
Solenoid valve multi-axis type (PIO specification)		MSEP-④-①-②-2-0	C: 8 (4 when high-output enabled) LC: 6 (3 when high-output enabled)	3 points		→P. 77
Positioner multi-axis type (Field network specification)		MSEP-④-①-③-0-0				
Program control multi-axis safety category type		MSEL-PG-1-42PWAI-①-2-4	4	30000 points	Single-phase AC 100V~230V	→P. 87
Program control multi-axis safety category type (w/ network board)		MSEL-PG-1-42PWAI-③-0-4				

*Above MSEL models are for single-axis specification *① I/O type (NP/PN) *③ Number of axes
 *② Field network specification code *④ N (NPN specification) or P (PNP specification) code
 *The high output enabled operation is only available when the "High-output setting specs" is selected in the MSEP-C/LC.

RCP5-BA7/BA7U RoboCylinder, Belt Type, Actuator Width 70mm, Pulse Motor, Top-mounted Motor/Bottom-mounted Motor

Model	RCP5	WA	56P	48		P3			
Specification	Series	Type	Encoder type	Motor type	Lead	Stroke	Applicable controllers	Cable length	Options
Items	BA7: Belt type Top-mounted motor BA7U: Belt type Bottom-mounted motor	WA: Battery-less absolute specification	56P: Pulse motor, size 56□	48: Equiv. to 48mm	300: 300mm 2600: 2600mm (Every 100mm)	P3: PCON-CA MSEP MSEL	N: No cable P: 1m S: 3m M: 5m X□: Specified length R□: Robot cable	Please refer to the options table below.	



* Depending on the model, there may be some limitations to using the side and ceiling mount positions. Please refer to

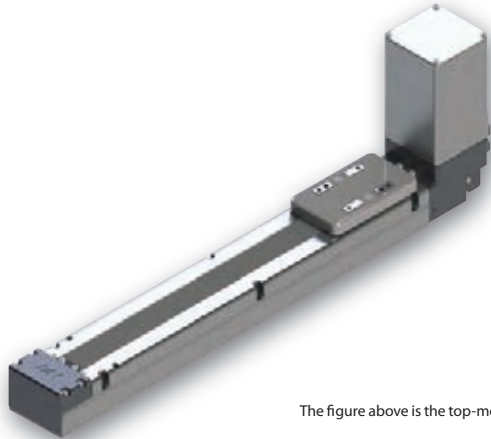

The figure above is the top-mounted motor type.



- Please set the operation speed at 100mm/s or higher for the belt type as it may cause vibration or noise when used at lower speed.
- Due to a pulse motor used for RCP5 series, its payload gets lower when operated at higher speed. Please refer to the correlation diagram of speed and payload on this page or to the selection table on P. 65 to make sure that the required payload will be met at the operation speed you desire.
- The payload assumes operation at an acceleration of 0.5G. 0.5G is the upper limit of the acceleration.
- Push-motion operation cannot be performed.

Correlation Diagram of Speed and Payload (when high-output setting of controller is enabled)

Due to a pulse motor used for RCP5 series, its payload gets lower when operated at higher speed. Please refer to this diagram below to make sure that the required payload will be met at the operation speed you desire.

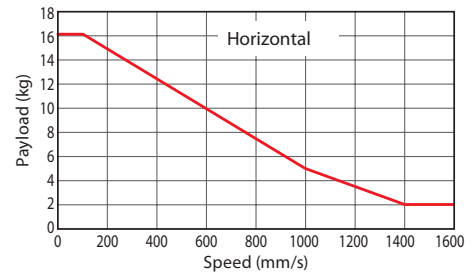

Warnings

- This model cannot be installed in the vertical mount position.
- Horizontal and ceiling mount specifications cannot be installed in the side position. Similarly, side mount specification cannot be installed in a horizontal or ceiling mount position.
- The maximum stroke for the side and ceiling mount positions is 1000mm.

Actuator Specifications

Lead and Payload

Model number	Motor attached side	Lead (mm)	Maximum payload		Stroke (mm)
			Horizontal (kg)		
RCP5-BA7-WA-56P-48-①-P3-②-③	Top	Equiv. to 48mm	16		300~2600 (Every 100mm)
RCP5-BA7U-WA-56P-48-①-P3-②-③	Bottom				

Legend: ① Stroke ② Cable length ③ Options

Stroke and Maximum Speed

(Unit: mm/s)

Lead (mm)	300 (mm)	400 (mm)	500 (mm)	600 (mm)	700 (mm)	800 (mm)	900 (mm)	1000~2600 (Every 100mm)
Equiv. to 48mm	890	1070	1220	1340	1450	1520	1550	1600

The values apply to high-output setting of controller.

Cable Length

Type	Cable code
Standard type	P (1m)
	S (3m)
	M (5m)
Special length	X06 (6m) ~X10 (10m)
	X11 (11m)~X15 (15m)
	X16 (16m)~X20 (20m)
	R01 (1m) ~R03 (3m)
Robot cable	R04 (4m) ~R05 (5m)
	R06 (6m) ~R10 (10m)
	R11 (11m)~R15 (15m)
	R16 (16m)~R20 (20m)

Options

Name	Option code	Reference page
Brake	B	→P. 11
Cable exit direction (Top)	CJT	→P. 11
Cable exit direction (Right)	CJR	→P. 11
Cable exit direction (Left)	CJL	→P. 11
Cable exit direction (Bottom)	CJB	→P. 11
Ceiling mount type	CIM	→P. 59
Left side-mount type	SIL	→P. 59
Right side-mount type	SIR	→P. 59
Non-motor end specification	NM	→P. 11

Actuator Specifications

Item	Description
Drive system	Timing belt
Positioning repeatability	±0.08mm
Lost motion	0.1mm or less
Base	Material: Aluminum with white alumite treatment
Dynamic allowable moment (*1)	Ma: 33.2N·m, Mb: 33.2N·m, Mc: 72.3N·m
Static allowable moment	Ma: 80.7N·m, Mb: 80.7N·m, Mc: 175N·m
Ambient operating temperature, humidity	0 to 40°C, 85% RH or less (Non-condensing)

(*1) Assumes a standard rated life of 5000km.

• Reference for overhang load lengths / Ma: 180mm or less, Mb, Mc: 180mm or less

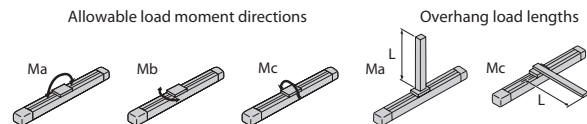

(Note)

The operational life will vary depending on operation and installation conditions. Please refer to the RC General Catalog for details on operational life, allowable moment direction, and overhang load length.

Dimensions

CAD drawings can be downloaded from the website.

www.robocylinder.de



*1 When the slider is returning to its home position, please be careful of interference from surrounding objects, as it will travel until it reaches the ME.
 ME: Mechanical end
 SE: Stroke end
 *The way to attach the actuator is to fix with screws from the top only.

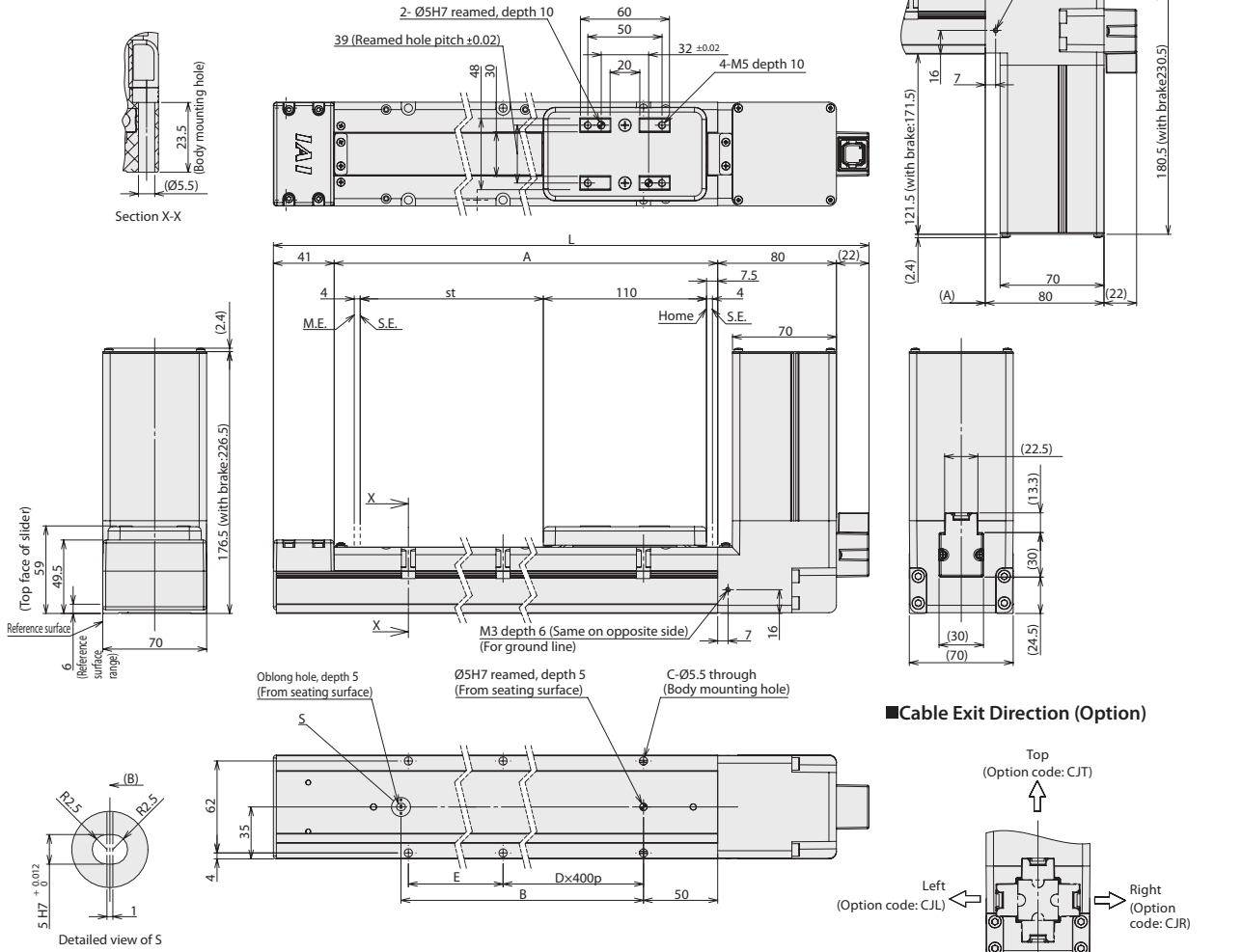

■ Dimensions and Mass by Stroke

Stroke	300	400	500	600	700	800	900	1000	1100	1200	1300	1400	1500	1600	1700	1800	1900	2000	2100	2200	2300	2400	2500	2600	
L	578	678	778	878	978	1078	1178	1278	1378	1478	1578	1678	1778	1878	1978	2078	2178	2278	2378	2478	2578	2678	2778	2878	
A	435	535	635	735	835	935	1035	1135	1235	1335	1435	1535	1635	1735	1835	1935	2035	2135	2235	2335	2435	2535	2635	2735	
B	340	440	540	640	740	840	940	1040	1140	1240	1340	1440	1540	1640	1740	1840	1940	2040	2140	2240	2340	2440	2540	2640	
C	4	4	6	6	6	6	8	8	8	8	10	10	10	10	12	12	12	12	14	14	14	14	16	16	
D	0	0	1	1	1	1	2	2	2	2	3	3	3	3	4	4	4	4	5	5	5	5	6	6	
E	335	435	135	235	335	435	135	235	335	435	135	235	335	435	135	235	335	435	135	235	335	435	135	235	
Mass (kg)	Without brake	3.8	4.1	4.4	4.8	5.1	5.4	5.8	6.1	6.5	6.8	7.1	7.5	7.8	8.1	8.5	8.8	9.1	9.5	9.8	10.2	10.5	10.8	11.2	11.5
	With brake	4.4	4.7	5	5.4	5.7	6	6.4	6.7	7.1	7.4	7.7	8.1	8.4	8.7	9.1	9.4	9.7	10.1	10.4	10.8	11.1	11.4	11.8	12.1

*The weights shown in the table above are for BA7. The weight increases by 0.2kg for BA7U.

Applicable Controllers

The RCP5 series actuators can be operated by the controllers indicated below. Please select the type depending on your intended use.

Name	External view	Model number	Max. number of controlled axes	Maximum number of positioning points	Input power	Reference page
Positioner type (High-output specification)		PCON-CA-56PWAI-①-2-0	1	512 points	DC24V	→P. 69
Pulse train type (High-output specification)		PCON-CA-56PWAI-PL②-2-0				
Field network type (High-output specification)		PCON-CA-56PWAI-③-0-0				
Solenoid valve multi-axis type (PIO specification)		MSEP-④-⑤-⑥-⑦-⑧-2-0	C: 8 (4 when high-output enabled) LC: 6 (3 when high-output enabled)	3 points		→P. 77
Positioner multi-axis type (Field network specification)		MSEP-④-⑤-⑥-⑦-⑧-0-0				
Program control multi-axis safety category type		MSEL-PG-1-56PWAI-①-2-4	4	30000 points	Single-phase AC 100V~230V	→P. 87
Program control multi-axis safety category type (w/ network board)		MSEL-PG-1-56PWAI-③-0-4				

*Above MSEL models are for single-axis specification *① I/O type (NP/PN) *② Number of axes
 *③ Field network specification code *④ N (NPN specification) or P (PNP specification) code
 *⑤ C or LC *⑥ V (NPN specification) or P (PNP specification) code
 *The high output enabled operation is only available when the "High-output setting specs" is selected in the MSEP-C/LC.

Warnings When Installing the Rod Actuators

When installing the front bracket or flange (optional), please be careful that the actuator does not experience any external force. (External force may cause malfunctions or damaged parts)
If the actuator will experience external force or is being used in conjunction with a Cartesian robot etc., please use the mounting holes on the base of the actuator to secure it into place.

Even in cases when external force will not be applied, to secure the actuator in place when installed horizontally using a flange or side-mounted motor specification, please use the bracket mounting holes to create a support base as shown in the diagram on the right.

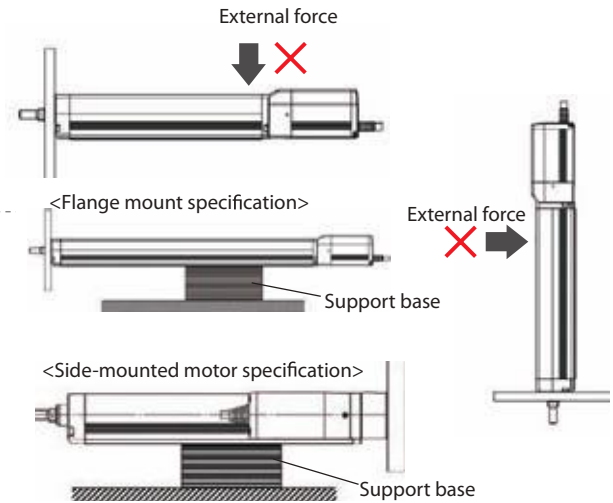

About the Mounting Positions

- While installation in the side and ceiling mount positions are available, this may cause slack or misalignment in the stainless steel sheet. Continuing to use it this way could cause the stainless steel sheet to break. Please inspect it daily and adjust the sheet if any slack or misalignment is found.
- When installing the motor straight-type vertically, please set the motor on the top if possible. While installing the motor on the bottom will not cause problems in normal operation, long periods of no activity may cause the grease to separate, flow into the motor unit, and cause problems in rare occasions.

Belt Type Mounting Positions

Horizontal and ceiling mount specifications cannot be installed in the side position. Similarly, side mount specification cannot be installed in a horizontal or ceiling mount position. Tilted or vertical mount installations will cause operational failure, so please do not install it in these positions. The maximum stroke for the side and ceiling mount positions is 1000mm. Please do not attempt to use a product with a stroke of more than 1000mm in the side or ceiling mount positions.

Selection Guideline (Correlation Diagram of Push Force and Current-limiting Value)

In the push operation, the push force can be changed by changing the current force of the controller to be between 20%-70% (for SA4□ and RA4□, start from 30%). The maximum push force will vary depending on the model, so please refer to the graphs on the following pages and select one based on the needed push force for your intended use.

When using the push operation with the slider actuator, please limit the push current in order that the reactive moment caused by the push force does not exceed the dynamic allowable moment (M_a , M_b) specified in the catalog. Please refer to the figure on the right which shows the guide moment's active positions for help with calculating the moment. This can be done by considering the offset of the push force application position. Please note that if excessive force which exceeds the dynamic allowable moment is applied, it may damage the guide and shorten its operational life. Please keep this in mind and select a push current that is safely within its limits.

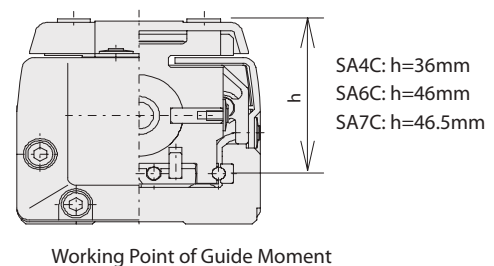

Calculation example:

If push-motion operation is performed with an RCP5-SA7C by applying 50N at the position shown to the right, the moment received by the guide, or

$$M_a, \text{ is calculated as } (46.5 + 50) \times 50 = 4825 \text{ (N}\cdot\text{mm)} \\ = 4.825 \text{ (N}\cdot\text{m)}.$$

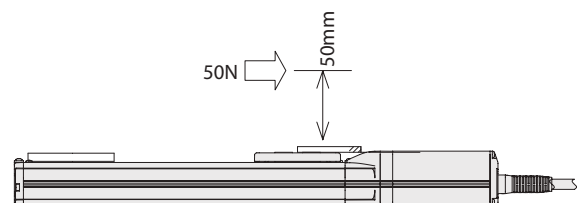

Since the dynamic allowable moment of the SA7C is $M_a=10$ (N·m), since $10 \times 0.8 = 8 > 4.825$, this is an acceptable selection. Also, should an M_b moment occur due to the push operation, calculate the moment from the overhang and ensure that it is within range of the dynamic allowable moment.

Correlation Diagrams of Push Force and Current Limit

The graphs below are only a reference, and the graphs may vary slightly from the actual

SA4C/SA4R/RA4C/RA4R type

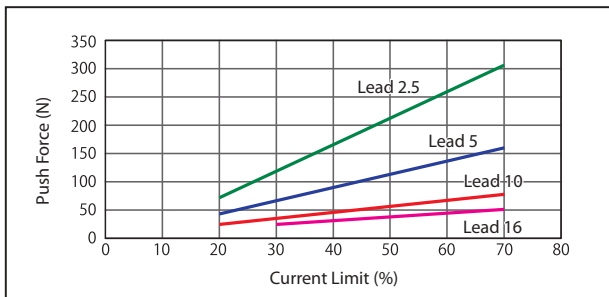

SA6C/SA6R/RA6C/RA6R type

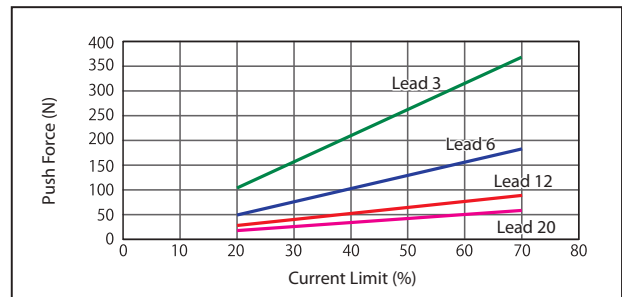

SA7C/SA7R type

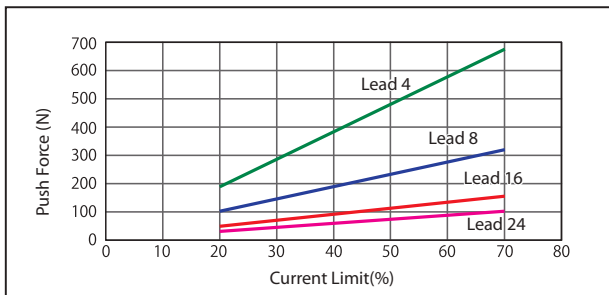

RA7C/RA7R type

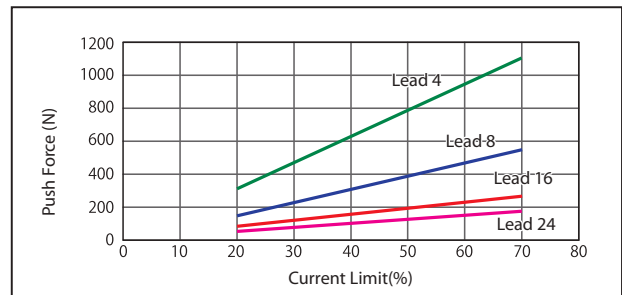

RA8C/RA8R type

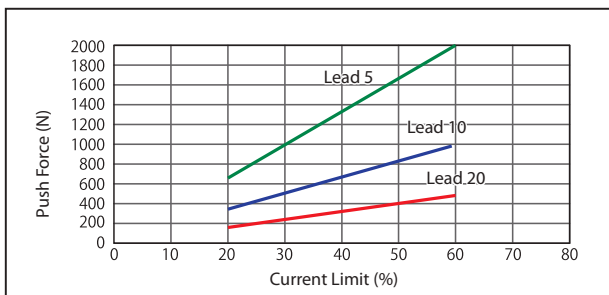

RA10C/RA10R type

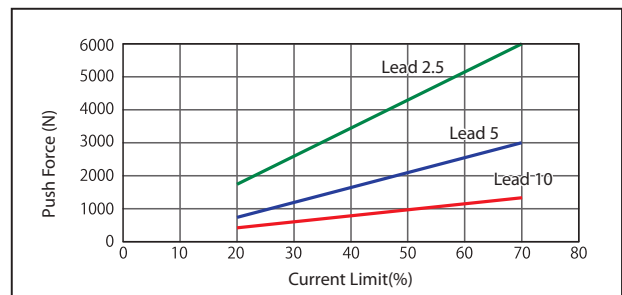

Warnings

- The correlation between push force and current limit are strictly for reference purposes. Actual numbers may vary slightly.
- A current limit of less than 20% will cause the push force to vary, so please use a limit of higher than 20%.
- Using the push operation, these graphs assume a traveling speed of 10mm/s for the RA8C/RA8R/RA10C/RA10R models and a 20mm/s speed for all other models.
- Using the RA8C/RA8R models at a current limit of greater than 70% can cause the motor to burn out, so please use a limit of 60% or less.
- Please refer to the table below when determining the upper limit of push cycles when the RCP5-RA10C/RA10R models are operated at the maximum push force and a push travel distance of 1mm.

Lead (type)	2.5	5	10
Push cycles	1.4 million cycles	25 million cycles	157.6 million cycles

*The upper limit of push cycles varies depending on the impact, vibration and other operating conditions. The cycles shown to the left assume no impact or vibration.

Warnings for RCP5-RA10C/RA10R Models Using the Push Operation

The push force is limited on certain RA10C/RA10R models due to its relationship with the buckling load of the ball screw. (Refer to the table below.)

Items	Stroke 550mm or less	Stroke 600mm or less	Stroke 650mm or less	Stroke 700mm or less	Stroke 750mm or less	Stroke 800mm or less
Lead 10	As shown in the push force graph					
Lead 5	As shown in the graph	2900	2500	2200	2000	1800
Lead 2.5	As shown in the graph					

RCP5 Series Belt Type Top-mounted Motor / Bottom-mounted Motor Specification

RCP5-BA4/BA4U

Orientation	Horizontal
Speed (mm/s)	Acceleration (G)
0	0.5G
200	1.5
800	1.5
1000	1
1200	0.5

RCP5-BA6/BA6U

Orientation	Horizontal
Speed (mm/s)	Acceleration (G)
0	0.5G
600	6
800	4
1000	3
1500	1

RCP5-BA7/BA7U

Orientation	Horizontal
Speed (mm/s)	Acceleration (G)
0	0.5G
100	16
1000	5
1400	2
1600	2

Selection Guideline (Selecting the Allowable Load for the Radial Cylinder)

The radial cylinder has a built-in guide, so loads up to a certain level can be applied to the rod without using an external guide. Refer to the graphs below for the allowable load mass. If the allowable load will be exceeded under the required operating conditions, add an external guide.

Allowable Load Mass for a Horizontally Mounted RCP5

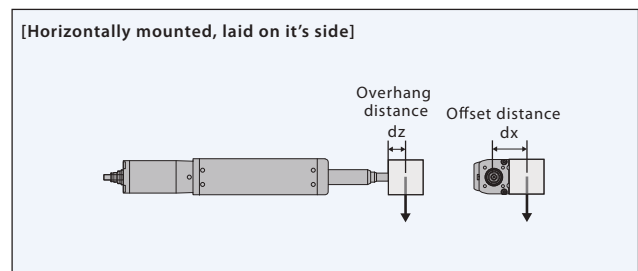
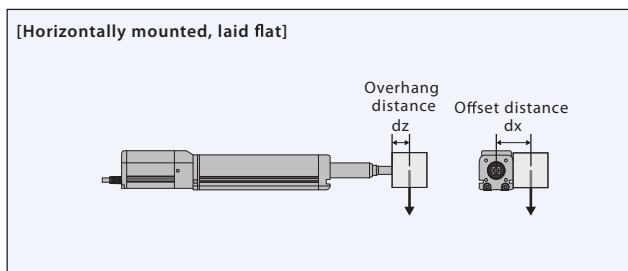

RCP5-RA4□/RA6□/RA7□

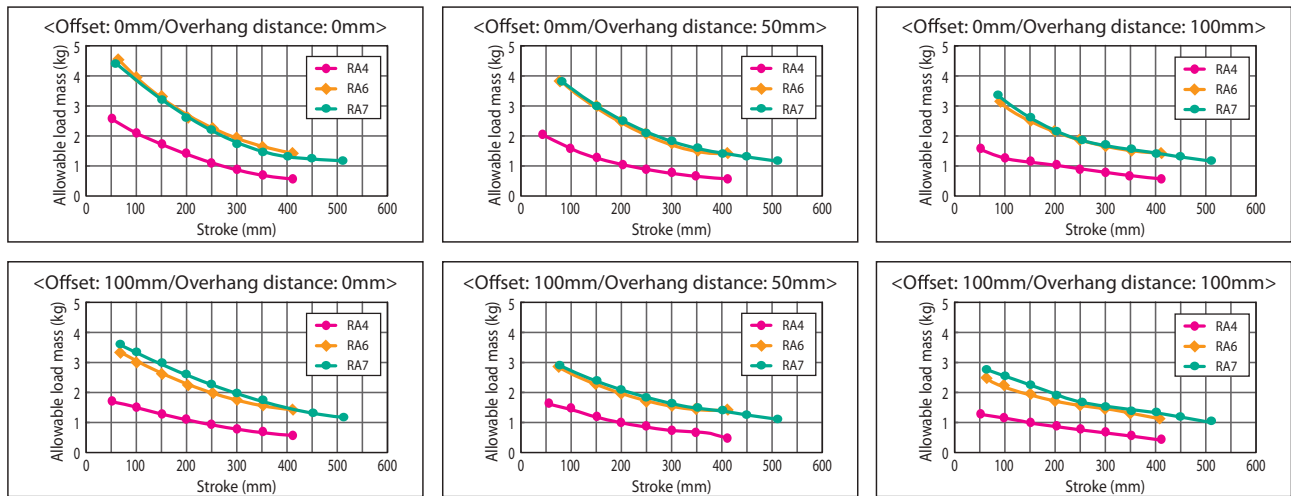

RCP5-RA8□/RA10□

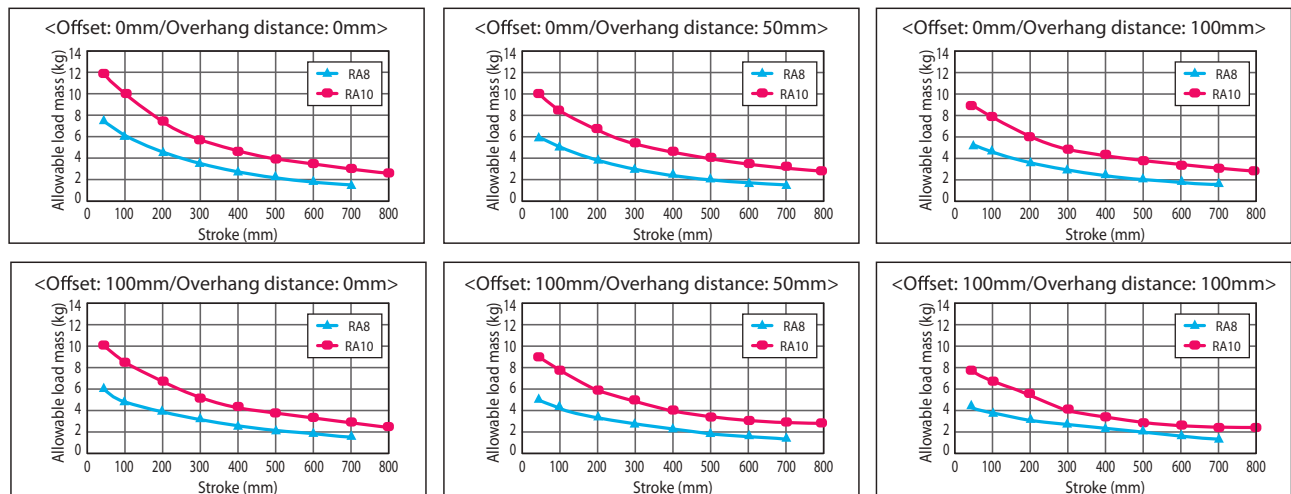

■ Allowable Load Mass for a Vertically Mounted RCP5

[Vertically mounted]

Eccentric distance (mm)

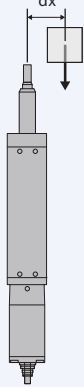

dx

Eccentric distance (mm)



dy

Allowable load calculation conditions:
 Load mass corresponding to a product traveling life of 5000 km, considering
 moments generated by acceleration/deceleration.
 (Maximum speed in the specification of speed.)

RCP5-RA4

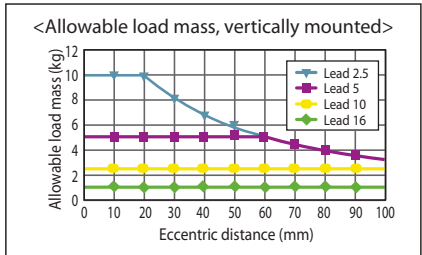

RCP5-RA6

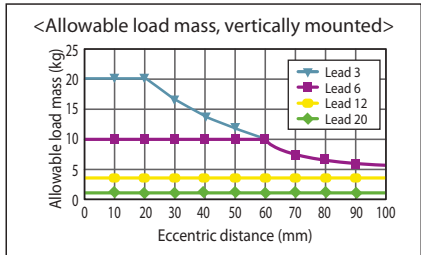

RCP5-RA7

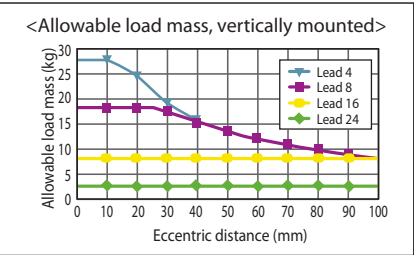

RCP5-RA8

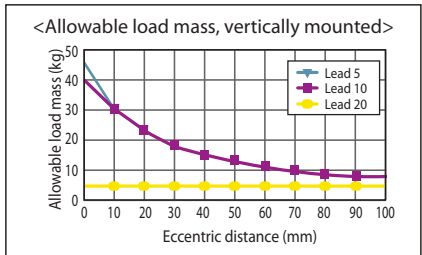

RCP5-RA10

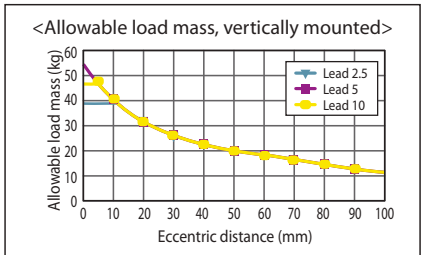

System Configuration

Single-axis Specification → Refer to P. 69

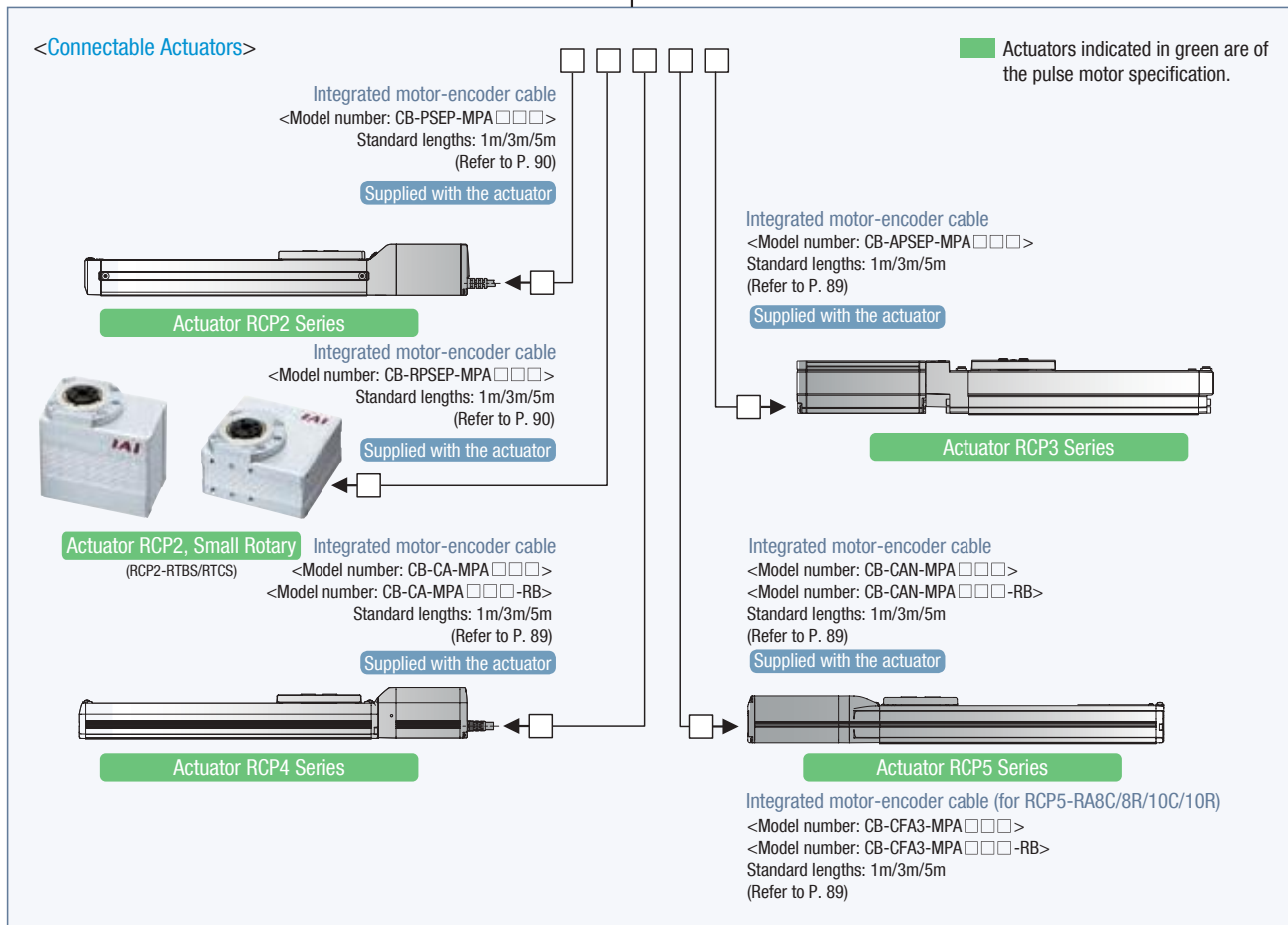
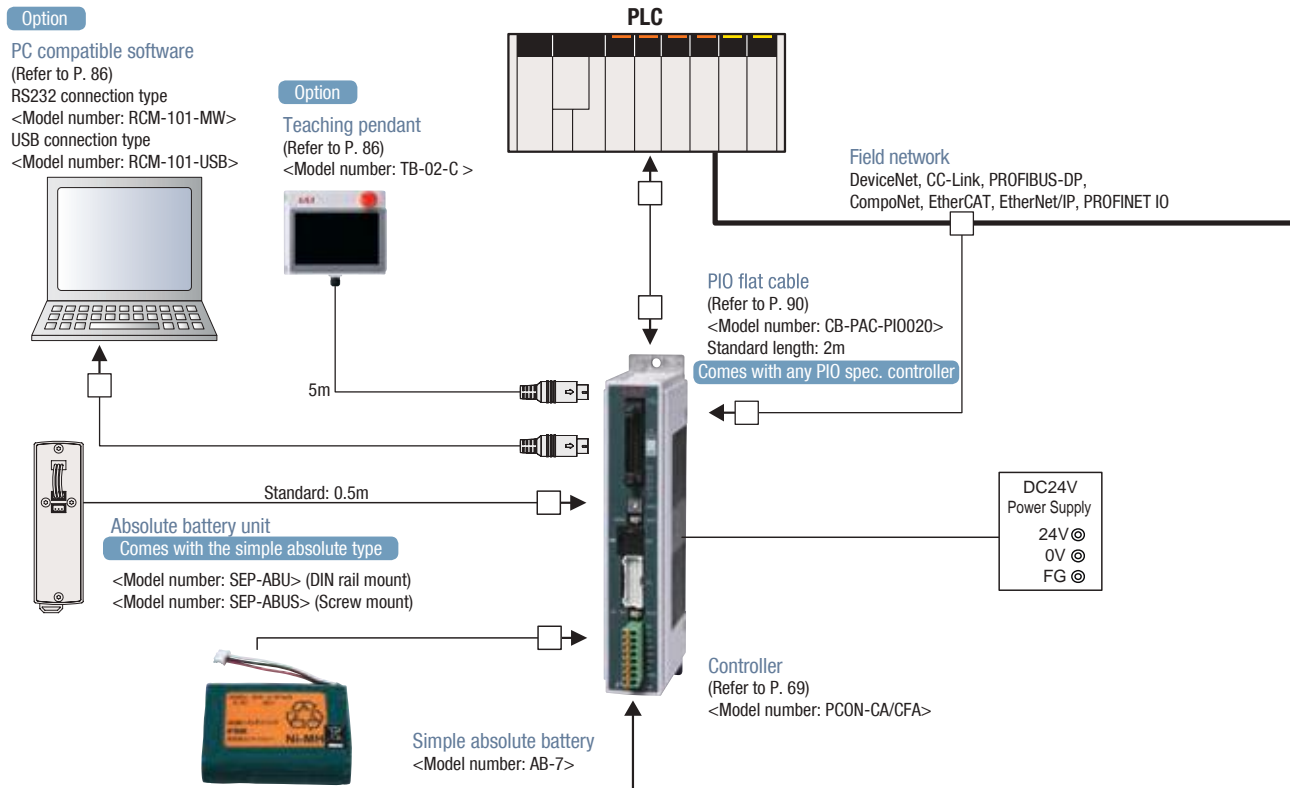

Multi-axis Specification (8-axis Specification/6-axis Specification with PLC Control Function) → Refer to P. 77

Option

PC compatible software
(Refer to P. 86)
RS232 connection type
<Model number: RCM-101-MW>
USB connection type
<Model number: RCM-101-USB>

*The PowerCon (high-output driver) and Mini Cylinder are supported by Ver. 9.06.00.00 or later.

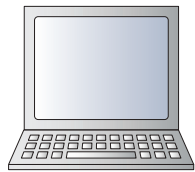

This cable comes with the PC compatible software

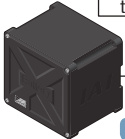

This cable comes with the absolute battery box.

Option
Absolute battery box
<Model number: MSEP-ABB>
Replacement battery
<Model number: AB-7>

Option
Teaching pendant
(Refer to P. 86)
<Model number: TB-02-C>



*If the "Simple absolute type" is selected for the controller model, the absolute battery box will come with the controller. (Refer to page 85 for its dimensions)

PLC

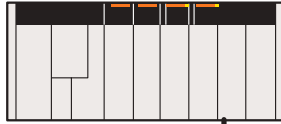

Field network
DeviceNet, CC-Link, PROFIBUS-DP, CompoNet, EtherCAT, EtherNet/IP, PROFINET IO

PIO flat cable
Refer to P. 90)
<Model number: CB-MSEP-PIO020>
Standard length: 2m
Comes with any PIO spec. controller

*You can choose either the PIO specification or field network specification for your controller.

*To connect to a field network, you must set up the controller communications using the gateway parameter setting tool that comes with the PC software. Please purchase the PC software if you don't already have it.

*Field network connection cables are the responsibility of the customer.



Controller
(Refer to P. 77)
<Model number: MSEP-C>
<Model number: MSEP-LC>

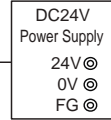

<Connectable Actuators>

Integrated motor-encoder cable
<Model number: CB-PSEP-MPA□□□>
Standard lengths: 1m/3m/5m
(Refer to P. 90)

Supplied with the actuator



Actuator RCP2 Series

*The RCP2-RTBS/RTCS are excluded.

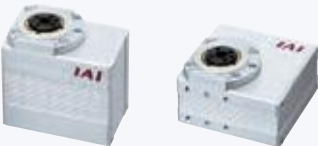

Actuator RCP2, Small Rotary
(RCP2-RTBS/RTCS)

Integrated motor-encoder cable
<Model number: CB-RPSEP-MPA□□□>
Standard lengths: 1m/3m/5m
(Refer to P. 90)

Supplied with the actuator

*Please note that 360 degree rotation specification (RCP2-RT□SL/RT□L/RT□BL) is not supported.



Actuator RCP4 Series

Integrated motor-encoder cable
<Model number: CB-CA-MPA□□□>

Integrated motor-encoder robot cable
<Model number: CB-CA-MPA□□□-RB>
Standard lengths: 1m/3m/5m
(Refer to P. 89)

Supplied with the actuator

Actuators indicated in green are of the pulse motor specification.
Actuators indicated in blue are of the servo motor specification.
Actuators indicated in orange are of the BLDC servo motor specification.

Integrated motor-encoder cable
<Model number: CB-APSEP-MPA□□□>
Standard lengths: 1m/3m/5m
(Refer to P. 90)

Supplied with the actuator



Actuator RCA Series

Integrated motor-encoder cable
<Model number: CB-APSEP-MPA□□□>
Standard lengths: 1m/3m/5m
(Refer to P. 89)

Supplied with the actuator

Actuator RCP3 Series RCP2-GRSS/GRLS/GRST
RCP2-SRA4R/SRGS4R/SRGD4R
RCA2 Series RCL Series (Note 1)

(Note 1) Please note that the simple absolute specification is not supported for the RCL series.

Integrated motor-encoder cable
<Model number: CB-CAN-MPA□□□>

Integrated motor-encoder robot cable
<Model number: CB-CAN-MPA□□□-RB>
Standard lengths: 1m/3m/5m
(Refer to P. 89)

Supplied with the actuator

Integrated motor-encoder cable
(for RCP5-RA8C/8R/10C/10R)

Integrated motor-encoder robot cable
<Model number: CB-CFA3-MPA□□□>
<Model number: CB-CFA3-MPA□□□-RB>
Standard lengths: 1m/3m/5m
(Refer to P. 89)

Actuator RCP5 Series
RCD Series

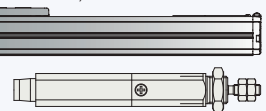



1 The built-in high-output driver designed for the RCP5/RCP4 achieves greater torque when operated at high speed

The newly developed high-output driver (patent pending) has achieved significant improvements compared to the conventional model (RCP2 Series), with a 1.4 times higher acceleration rate, 1.5 times higher maximum speed, and twice as much in payload.

(*) The rates of improvement vary depending on the type.
(*) The RCP3/RCP2 are also supported.
(*) PCON-CA only

Acceleration/ deceleration	RCP2	0.7G	1.4 times
	RCP5	1.0G	
Maximum speed	RCP2	1000mm/s	1.5 times
	RCP5	1440mm/s	
Payload	RCP2	6kg	2 times
	RCP5	12kg	

2 Battery-less absolute encoder compatibility

The RCP5 equipped with a battery-less absolute encoder is supported. Since no battery is needed to retain position data, less space is required in the control panel, which in turn leads to lower cost of your equipment.



3 A common board leads to improved ease of maintenance

While conventional controllers require a separate set of boards for each actuator, the PCON-CA/CFA use common boards for all actuators, meaning that actuators of different models such as RCP5, RCP4, RCP3 and RCP2 can be operated simply by changing the controller settings. The result is significant reduction in maintenance stock.

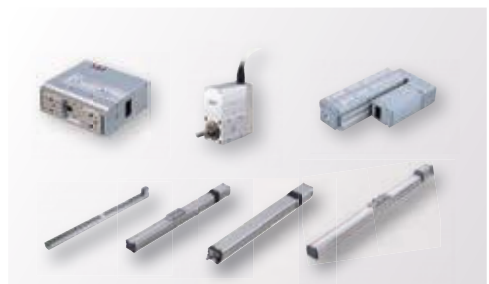

4 Smart tuning function, maintenance information, calendar function

You are able to set the optimal acceleration rate based on the transport load, by using the smart tuning function. In addition, you can record the number of times the actuator has moved and the distance it has traveled, for maintenance purposes.

(*) You need PC compatible software Ver. 8.03.00.00 or later or a TB-02 (teaching pendant) to use the smart tuning function.

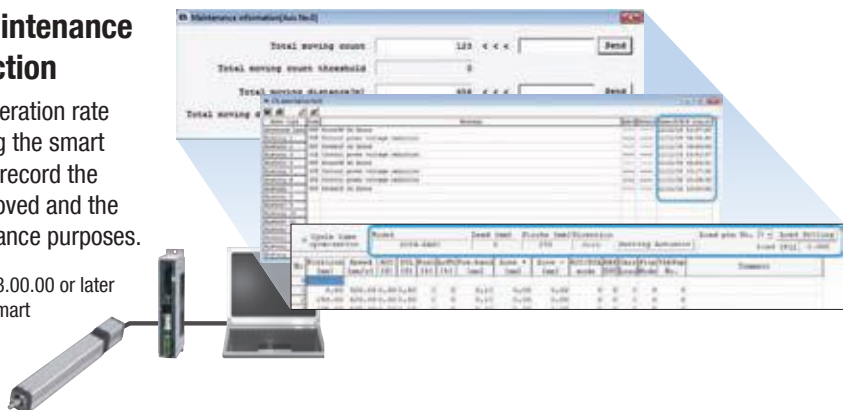

List of Models

Position Controllers for RoboCylinder: PCON-CA/CFA

I/O type		Positioner type	Pulse-train type (*1)	Field network type							
				DeviceNet	CC-Link	PROFIBUS	CompoNet	PROFINET	EtherCAT	EtherNet/IP	
I/O type model number		NP/PN	PLN/PLP	DV	CC	PR	CN	PRT	EC	EP	
PCON-CA	Battery-less absolute specification or Incremental specification	○	○	○	○	○	○	○	○	○	
	Simple absolute specification	with absolute battery	○	—	○	○	○	○	○	○	○
		with absolute battery unit	○	—	○	○	○	○	○	○	○
		No absolute battery	○	—	○	○	○	○	○	○	○
PCON-CFA	Battery-less absolute specification or Incremental specification	○	○	○	○	○	○	○	○	○	

(*1) If the RCP5 is used with pulse-train I/Os, the actuator must complete a home return prior to operation, as with any incremental actuator.

Model Specification Items

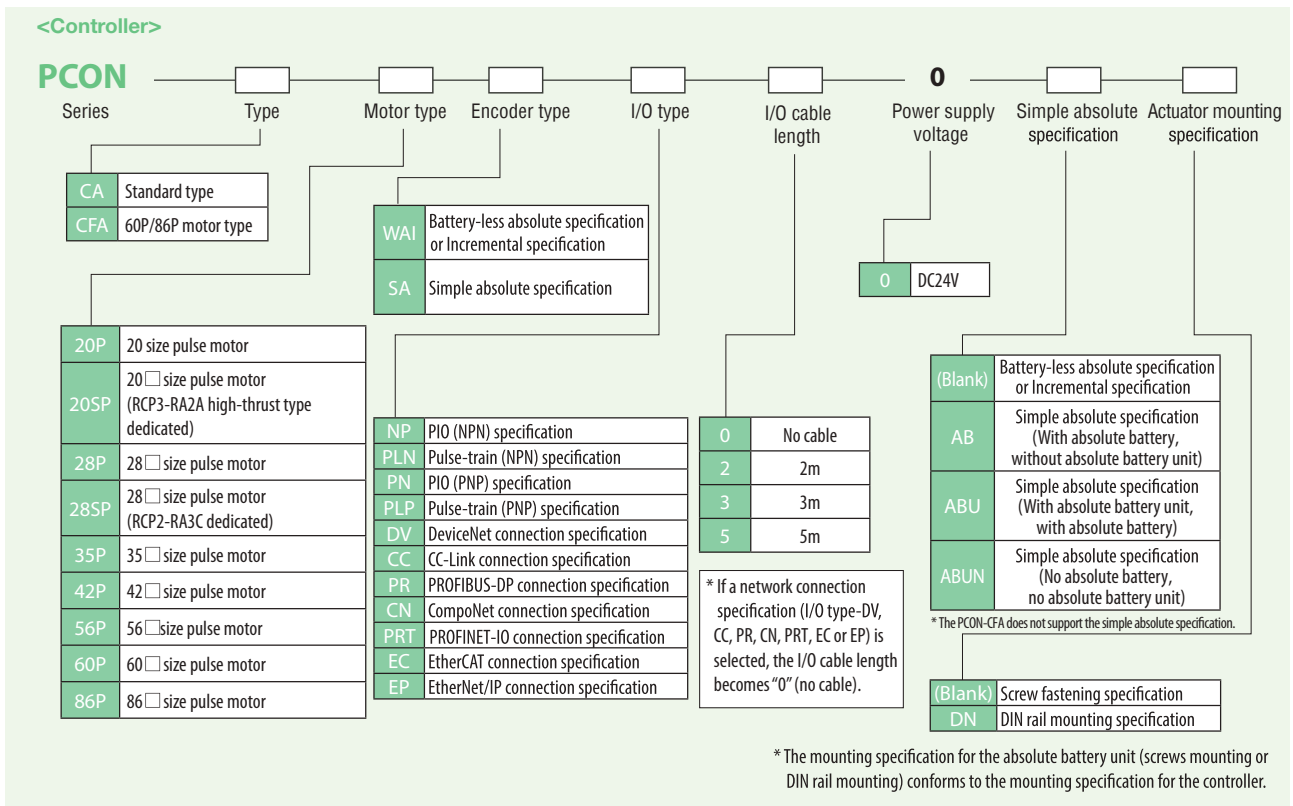

PIO I/O Interface

Input Part External Input Specifications

Item	Specification
Input voltage	DC24V ±10%
Input current	5 mA, 1 circuit
ON/OFF voltage	ON voltage: 18 VDC min. OFF voltage: 6 VDC max.

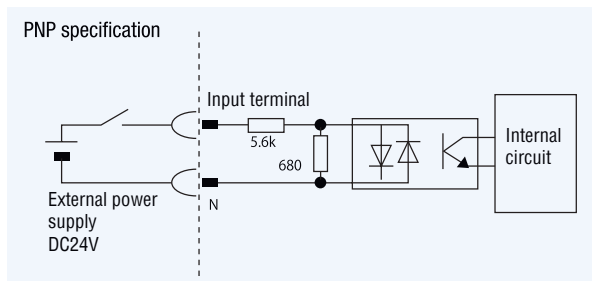
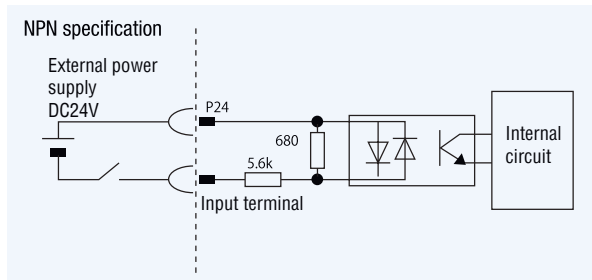

Output Part External Output Specifications

Item	Specification
Load voltage	DC24V
Maximum load current	50 mA, 1 circuit
Leak current	2 mA max. per point

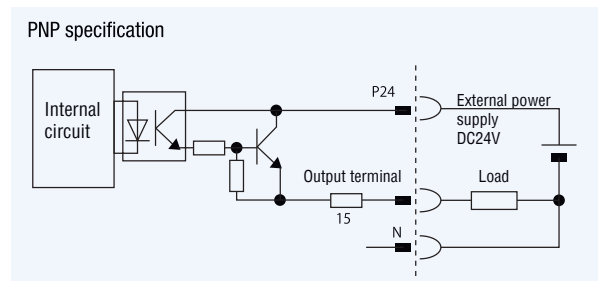
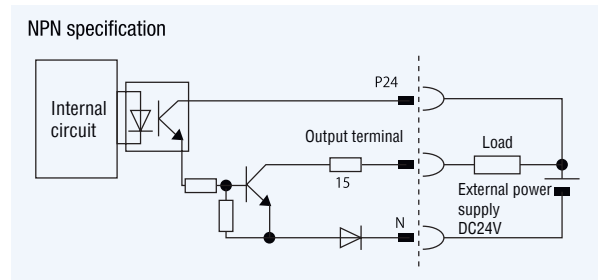

Types of PIO Patterns (Control Patterns)

This controller supports seven types of control methods. Please select the PIO pattern that best suits your purpose in Parameter No. 25, "PIO Pattern Selection".

Type	Set value of Parameter No. 25	Mode	Overview
PIO pattern 0	0 (factory setting)	Positioning mode (standard type)	<ul style="list-style-type: none"> Number of positioning points: 64 points Position number command: Binary Coded Decimal (BCD) Zone signal output (*1) : 1 point Position zone signal output (*2) : 1 point
PIO pattern 1	1	Teaching mode (teaching type)	<ul style="list-style-type: none"> Number of positioning points: 64 points Position number command: Binary Coded Decimal (BCD) Position zone signal output (*2) : 1 point Jog (inching) operation using PIO signals is supported. Current position data can be written to the position table using PIO signals.
PIO pattern 2	2	256-point mode (256 positioning points)	<ul style="list-style-type: none"> Number of positioning points: 256 points Position number command: Binary Coded Decimal (BCD) Position zone signal output (*2) : 1 point
PIO pattern 3	3	512-point mode (512 positioning points)	<ul style="list-style-type: none"> Number of positioning points: 512 points Position number command: Binary Coded Decimal (BCD) No zone signal output
PIO pattern 4	4	Solenoid valve mode 1 (7-point type)	<ul style="list-style-type: none"> Number of positioning points: 7 points Position number command: Individual number signal ON Zone signal output (*1) : 1 point Position zone signal output (*2) : 1 point
PIO pattern 5	5	Solenoid valve mode 2 (3-point type)	<ul style="list-style-type: none"> Number of positioning points: 3 points Position number command: Individual number signal ON Completion signal: A signal equivalent to a LS (limit switch) signal can be output. Zone signal output (*1) : 1 point Position zone signal output (*2) : 1 point
PIO pattern 6 (Note 1)	6	Pulse-train control mode	<ul style="list-style-type: none"> Differential pulse input (200 kpps max.) Home return function Zone signal output (*1) : 2 points No feedback pulse output

(*1) Zone signal output: A desired zone is set by Parameter Nos. 1 and 2 or 23 and 24, and the set zone always remains effective once home return has completed.

(*2) Position zone signal output: This function is available as part of a position number. A desired zone is set in the position table and becomes effective only when the corresponding position is specified, but not with commands specifying other positions.

(Note 1) Pulse Train Control Model is available only if the pulse train control type is indicated (from PCON-CA-PLN and PLP) at the time of purchase.

PIO Patterns and Signal Assignments

The table below lists the signal assignments for the I/O flat cable under different PIO patterns. Connect an external device (such as a PLC) according to this table.

Pin number	Category	PIO function	Parameter No. 25, "PIO pattern selection"					
			0	1	2	3	4	5
			Positioning mode	Teaching mode	256-point mode	512-point mode	Solenoid valve mode 1	Solenoid valve mode 2
	Input	Number of positioning points	64 points	64 points	256 points	512 points	7 points	3 points
		Home return signal	○	○	○	○	○	—
		Jog signal	—	○	—	—	—	—
		Teaching signal (writing of current position)	—	○	—	—	—	—
	Output	Brake release	○	—	○	○	○	○
		Moving signal	○	○	—	—	—	—
		Zone signal	○	△ (Note 1)	△ (Note 1)	—	○	○
		Position zone signal	○	○	○	—	○	○
1A	24V	P24						
2A	24V	P24						
3A	Pulse input	—						
4A		—						
5A	Input	IN0	PC1	PC1	PC1	PC1	ST0	ST0
6A		IN1	PC2	PC2	PC2	PC2	ST1	ST1(JOG+)
7A		IN2	PC4	PC4	PC4	PC4	ST2	ST2(-)
8A		IN3	PC8	PC8	PC8	PC8	ST3	—
9A		IN4	PC16	PC16	PC16	PC16	ST4	—
10A		IN5	PC32	PC32	PC32	PC32	ST5	—
11A		IN6	—	MODE	PC64	PC64	ST6	—
12A		IN7	—	JISL	PC128	PC128	—	—
13A		IN8	—	JOG+	—	PC256	—	—
14A		IN9	BKRL	JOG-	BKRL	BKRL	BKRL	BKRL
15A		IN10	RMOD	RMOD	RMOD	RMOD	RMOD	RMOD
16A		IN11	HOME	HOME	HOME	HOME	HOME	—
17A		IN12	*STP	*STP	*STP	*STP	*STP	—
18A		IN13	CSTR	CSTR/PWRT	CSTR	CSTR	—	—
19A		IN14	RES	RES	RES	RES	RES	RES
20A	IN15	SON	SON	SON	SON	SON	SON	
1B	Output	OUT0	PM1(ALM1)	PM1(ALM1)	PM1(ALM1)	PM1(ALM1)	PE0	LSO
2B		OUT1	PM2(ALM2)	PM2(ALM2)	PM2(ALM2)	PM2(ALM2)	PE1	LS1(TRQS)
3B		OUT2	PM4(ALM4)	PM4(ALM4)	PM4(ALM4)	PM4(ALM4)	PE2	LS2 (Note2)
4B		OUT3	PM8(ALM8)	PM8(ALM8)	PM8(ALM8)	PM8(ALM8)	PE3	—
5B		OUT4	PM16	PM16	PM16	PM16	PE4	—
6B		OUT5	PM32	PM32	PM32	PM32	PE5	—
7B		OUT6	MOVE	MOVE	PM64	PM64	PE6	—
8B		OUT7	ZONE1	MODES	PM128	PM128	ZONE1	ZONE1
9B		OUT8	PZONE/ZONE2	PZONE/ZONE1	PZONE/ZONE1	PM256	PZONE/ZONE2	PZONE/ZONE2
10B		OUT9	RMDS	RMDS	RMDS	RMDS	RMDS	RMDS
11B		OUT10	HEND	HEND	HEND	HEND	HEND	HEND
12B		OUT11	PEND	PEND/WEND	PEND	PEND	PEND	—
13B		OUT12	SV	SV	SV	SV	SV	SV
14B		OUT13	*EMGS	*EMGS	*EMGS	*EMGS	*EMGS	*EMGS
15B		OUT14	*ALM	*ALM	*ALM	*ALM	*ALM	*ALM
16B	OUT15	LOAD/TRQS *ALML	*ALML	LOAD/TRQS *ALML	LOAD/TRQS *ALML	LOAD/TRQS *ALML	*ALML	
17B	Pulse input	—						
18B		—						
19B	0V	N						
20B	0V	N						

(Note) In the table above, asterisk symbol "*" accompanying each code indicates a negative logic signal. PM1 to PM8 are alarm binary code output signals that are used when an alarm generates.

(Note 1) In all PIO patterns other than 3, this signal can be switched with PZONE by setting Parameter No. 149 accordingly.

(Note 2) The setting will not become effective until the home return is completed.

Reference) Negative logic signal

Signals denoted by "*" are negative logic signals. Negative logic input signals are processed when turned OFF. Negative logic output signals normally remain ON while the power is supplied, and turn OFF when the signal is output. Note: The names of the signals above inside "()" are functions before the unit returns home.

Pulse-train Control Circuit

■ Host Unit = Differential Type

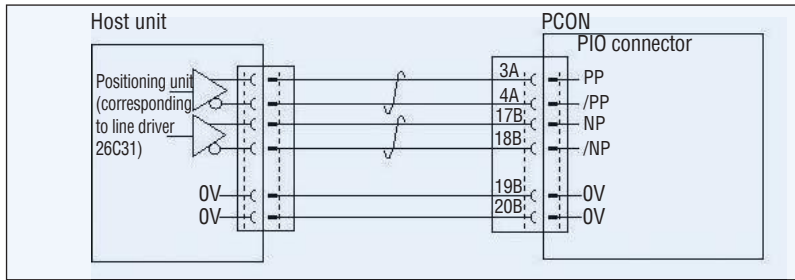

■ Host Unit = Open Collector Type The AK-04 (optional) is needed to input pulses.

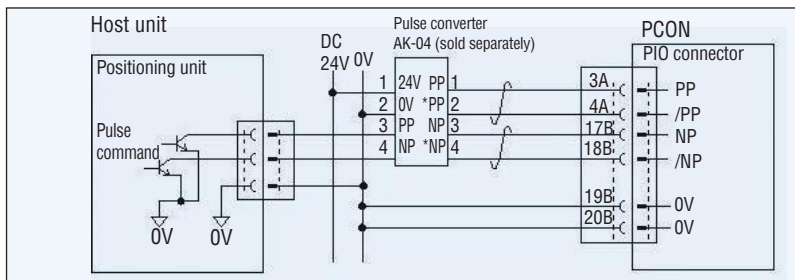

⚠ Caution: Use the same power supply for open collector input/output to/from the host and for the AK-04.

Command Pulse Input Patterns

	Command pulse-train pattern	Input terminal	Forward	Reverse	
Negative logic	Forward pulse-train	PP·/PP			
	Reverse pulse-train	NP·/NP			
	A forward pulse-train indicates the amount of motor rotation in the forward direction, while a reverse pulse-train indicates the amount of motor rotation in the reverse direction.				
	Pulse-train	PP·/PP			
	Sign	NP·/NP	Low	High	
	The command pulses indicate the amount of motor rotation, while the sign indicates the rotating direction.				
Positive logic	Forward pulse-train	PP·/PP			
	Reverse pulse-train	NP·/NP			
	Command phases A and B having a 90° phase difference (multiplier is 4) indicate the amount of rotation and the rotating direction.				
	Phase A/B pulse-train	PP·/PP			
	Phase A/B pulse-train	NP·/NP			
	Sign	NP·/NP	High	Low	

I/O Signals in Pulse-train Control Mode

The table below lists the signal assignments for the flat cable in the pulse-train control mode. Connect an external device (such as PLC) according to this table.

Pin number	Category	I/O number	Signal abbreviation	Signal name	Function description
1A	24V		P24	Power supply	I/O power supply +24 V
2A	24V		P24	Power supply	I/O power supply +24 V
3A	Pulse input		PP	Differential pulse-train input (+)	Differential pulses are input from the host. Up to 200 kpps can be input.
4A			/PP	Differential pulse-train input (-)	
5A	Input	N0	SON	Servo ON	The servo is ON while this signal is ON, and OFF while the signal is OFF.
6A		IN1	RES	Reset	Present alarms are reset when this signal is turned ON.
7A		IN2	HOME	Home return	Home return operation is performed when this signal is turned ON.
8A		IN3	TL	Torque limit selection	When this signal is turned ON, the motor torque is limited to the value set by the parameter.
9A		IN4	CSTP	Forced stop	The actuator is forcibly stopped when this signal has remained ON for 16 ms or more. The actuator decelerates to a stop at the torque set in the controller and the servo turns OFF.
10A		IN5	DCLR	Deviation counter clear	This signal clears the deviation counter.
11A		IN6	BKRL	Forced brake release	The brake is forcibly released.
12A		IN7	RMOD	Operation mode switching	The operation mode can be switched when the MODE switch on the controller is set to AUTO. (AUTO when this signal is OFF, and to MANU when the signal is ON.)
13A		IN8	NC	—	Not used
14A		IN9	NC	—	Not used
15A		IN10	NC	—	Not used
16A		IN11	NC	—	Not used
17A		IN12	NC	—	Not used
18A		IN13	NC	—	Not used
19A		IN14	NC	—	Not used
20A	IN15	NC	—	Not used	
1B	Output	OUT0	PWR	System ready	This signal turns ON when the controller becomes ready after the main power has been turned on.
2B		OUT1	SV	Servo ON status	This signal turns ON when the servo is ON.
3B		OUT2	INP	Positioning complete	This signal turns ON when the amount of remaining travel pulses in the deviation counter falls within the in-position band.
4B		OUT3	HEND	Home return complete	This signal turns ON upon completion of home return.
5B		OUT4	TLR	Torque limited	This signal turns ON upon reaching the torque limit while the torque is limited.
6B		OUT5	*ALM	Controller alarm status	This signal turns ON when the controller is normal, and turns OFF when an alarm generates.
7B		OUT6	*EMGS	Emergency stop status	This signal turns ON when the emergency stop of the controller is cancelled, and turns OFF when an emergency stop is actuated.
8B		OUT7	RMDS	Operation mode status	The operation mode status is output. This signal turns ON when the controller is in the manual mode.
9B		OUT8	ALM1	Alarm code output signal	An alarm code is output when an alarm generates. For details, refer to the operation manual.
10B		OUT9	ALM2		
11B		OUT10	ALM4		
12B		OUT11	ALM8		
13B		OUT12	*ALML	Minor failure alarm	This signal is output when a message-level alarm generates.
14B		OUT13	NC	—	Not used
15B		OUT14	ZONE1	Zone signal 1	This signal turns ON when the current position of the actuator falls within the parameter-set range.
16B	OUT15	ZONE2	Zone signal 2		
17B	Pulse input		NP	Differential pulse-train input (+)	Differential pulses are input from the host. Up to 200 kpps can be input.
18B			/NP	Differential pulse-train input (-)	
19B	0V		N	Power supply	I/O power supply 0 V
20B	0V		N	Power supply	I/O power supply 0 V

(Note) "*" indicates a negative logic signal. Negative logic signals are normally ON while the power is supplied, and turn OFF when the signal is output.

(Note) The number of encoder pulses is 800 with all RCP5 series models. For details, refer to the operation manual.

Field Network Specification: Explanation of Operation Modes

If the PCON-CA is controlled via a field network, you can select one of the following five modes to operate the actuator. Please note that the data areas required on the PLC side will vary depending on the mode.

Mode Description

	Mode	Description
0	Remote I/O mode	In this mode, the actuator is operated by controlling the ON/OFF of bits via the network, just like with the PIO specification. The number of positioning points and functions vary with each of the operation patterns (PIO patterns) that can be set by the controller's parameter.
1	Position/simple direct numerical mode	The target position is specified by directly entering a value, while other operating conditions (speed, acceleration, etc.) are set by specifying the desired position number corresponding to the desired operating conditions already input to the position data table.
2	Half direct numerical mode	The actuator is operated by specifying the speed, acceleration/deceleration and push current, in addition to the target position, by directly entering values.
3	Full direct numerical mode	The actuator is operated by specifying the target position, speed, acceleration/deceleration, push current control value, etc., by directly entering values. The current position, current speed, command current, etc., can also be read.
4	Remote I/O mode 2	Same as the above remote I/O mode, plus the current position read function and command current read function.

Required Data Size for Each Network

		DeviceNet	CC-Link	PROFIBUS-DP	CompoNet	PROFINET-IO	EtherCAT	EtherNet/IP
0	Remote I/O mode	1CH	1 station	2 bytes	2 bytes	2 bytes	2 bytes	2 bytes
1	Position/simple direct numerical mode	4CH	1 station	8 bytes	8 bytes	8 bytes	8 bytes	8 bytes
2	Half direct numerical mode	8CH	2 stations	16 bytes	16 bytes	16 bytes	16 bytes	16 bytes
3	Full direct numerical mode	16CH	4 stations	32 bytes	32 bytes	32 bytes	32 bytes	32 bytes
4	Remote I/O mode 2	6CH	1 station	12 bytes	12 bytes	12 bytes	12 bytes	12 bytes

List of Functions by Operation Mode

	Remote I/O mode	Position/simple direct numerical mode	Half direct numerical mode	Full direct numerical mode	Remote I/O mode 2
Number of positioning points	512 points	768 points	Unlimited	Unlimited	512 points
Operation by direct position data specification	—	○	○	○	—
Direct speed/acceleration specification	—	—	○	○	—
Push-motion operation	○	○	○	○	○
Current position read	—	○	○	○	○
Current speed read	—	—	○	○	—
Operation by position number specification	○	○	—	—	○
Completed position number read	○	○	—	—	○

* "○" indicates that the operation is supported, and "—" indicates that it is not supported.

External Dimensions

PCON-CA

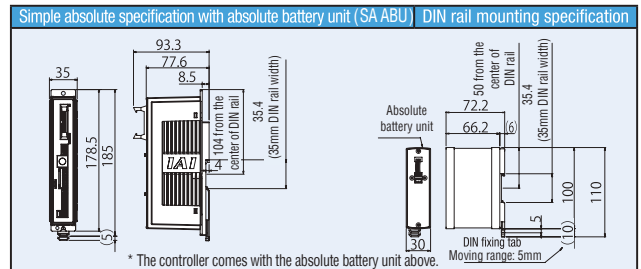
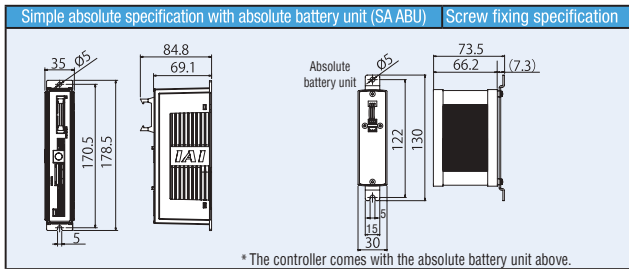
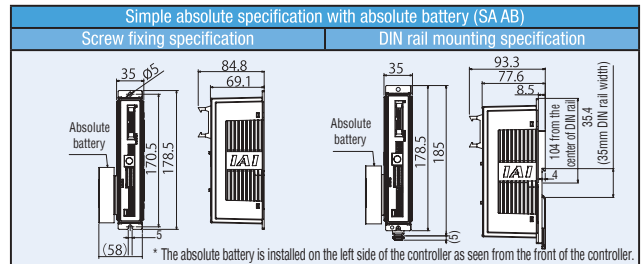
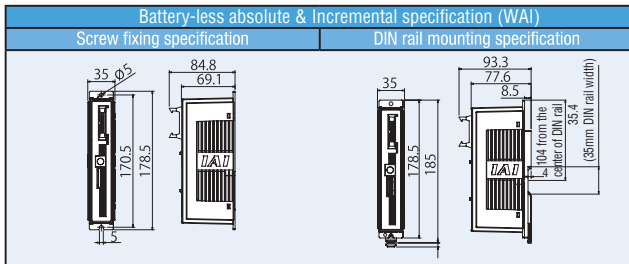

PCON-CFA

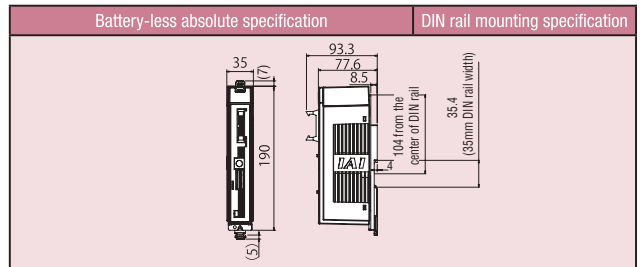
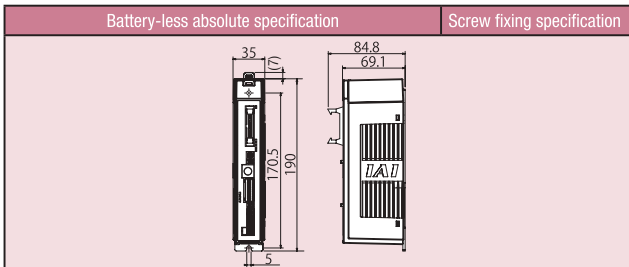

Specification List

Item	Description				
	PCON-CA	PCON-CFA			
Number of controlled axes	1 axis				
Power-supply voltage	DC24V±10%				
Load current (including control-side current consumption) (Note 1)	RCP2 RCP3	Motor type	20P, 28P, 28SP 42P, 56P 60P, 86P	1 A max. 2.2 A max.	
		Motor type	28P, 35P, 42P, 56P, 42SP 60P, 86P, 56SP	High-output setting disabled: 2.2 A max. High-output setting enabled: 3.5 A rated / 4.2 A max.	
	RCP4 RCP5	Motor type	28P, 35P, 42P, 56P, 42SP 60P, 86P, 56SP	High-output setting disabled: 2.2 A max. High-output setting enabled: 3.5 A rated / 4.2 A max.	6 A max.
		Motor type	28P, 35P, 42P, 56P, 42SP 60P, 86P, 56SP	High-output setting disabled: 2.2 A max. High-output setting enabled: 3.5 A rated / 4.2 A max.	6 A max.
Electromagnetic brake power (for actuator with brake)	DC24V ±10% 0.15A (max)				
Rush current (Note 2)	8.3A				
Momentary power failure resistance	MAX.500μs				
Supported encoder	Battery-less absolute encoder/incremental encoder				
Actuator cable length	20m max.				
External interface	PIO specification	Dedicated 24-VDC signal inputs/outputs (NPN/PNP selectable) --- Up to 16 input points, up to 16 output points, cable length up to 10m			
	Field network specification	DeviceNet, CC-Link, PROFIBUS-DP, CompoNet, PROFINET-IO, EtherCAT, EtherNet/IP			
Data setting, input method	PC software, touch panel teaching pendant, teaching pendant				
Data retention memory	Position data and parameters are saved in non-volatile memory. (There are no limits to how many times the memory can be rewritten.)				
Operation mode	Positioner mode/pulse-train control mode (selectable by parameter setting)				
Number of positioner-mode positions	Up to 512 points for positioner type or up to 768 points for network type (Note) The total number of positioning points varies depending on which PIO pattern is selected.				
Pulse-train interface	Input pulses	Differential type (line-driver type): 200 kpps max., cable length up to 10m			
		Open-collector type: Not supported. * If the host uses open-collector outputs, use the separately sold AK-04 (optional) to change them to differential outputs.			
	Command pulse magnification (Electronic gear: A/B)	1/50 < A/B < 50/1 Setting range of A and B (set by parameters): 1 to 4096			
Feedback pulse output	None				
Insulation resistance	Not less than 10 MΩ at 500 VDC,				
Electric shock protection mechanism	Class 1, basic insulation				
Mass (Note 3)	Incremental specification	Screw fixing type: Not more than 250g / DIN rail fixing type: Not more than 285g	Screw fixing type: Not more than 270g / DIN rail fixing type: Not more than 305g		
	Simple absolute specification (including 190 g for battery)	Screw fixing type: Not more than 450g / DIN rail fixing type: Not more than 485g			
Cooling method	Natural cooling by air		Forced cooling by air		
Environment	Ambient operating temperature	0 to 40°C			
	Ambient operating humidity	Not more than 85% RH (non-condensing)			
	Operating ambience	Free from corrosive gases			
	Degree of protection	IP20			

Note 1) 0.3 A higher for the field network specification.

Note 2) Rush current flows for approx. 5 msec after the power is input (at 40°C). Exercise caution that the rush current value varies depending on the impedance of the power line.

Note 3) 30 g heavier for the field network specification.



1 Adding the PLC Function

MSEP-LC

This function makes it possible to operate actuators using a ladder logic program, and to control the state of I/O (Input/Output) signals. If your system is small enough, it can be controlled using only the MSEP-LC. In a large scale system an MSEP-LC can perform distributed control of each process and reduce the load of a main PLC. In addition, it can also simplify your program and make troubleshooting easier.

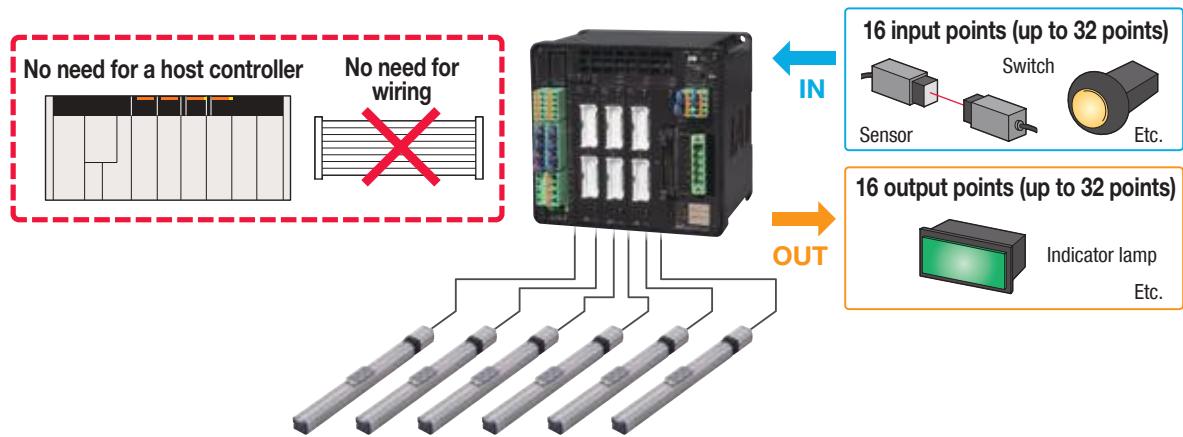

2 Supporting Actuators with the Battery-less Absolute Encoder

MSEP-LC MSEP-C

Features of actuators with the battery-less absolute encoder

- A** Home return is no longer necessary, so these actuators start and restart quicker than incremental actuators to begin working right away. They are also free from problems relating to home return, such as position shift.
- C** Compared to standard absolute actuators, no battery is required, which results in the following benefits:
 - ▶ No need to purchase or replace batteries
 - ▶ No need to control the stocks and replacement timing of batteries
 - ▶ No need to make adjustment (absolute reset) normally required after battery replacement

RoboCylinder with the battery-less absolute encoder

RCP5



3 Supporting the PowerCon (High-output Driver) and Micro Cylinder

MSEP-LC MSEP-C

When the PowerCon (newly developed high-output driver) is installed and combined with the RCP5 or RCP4, it has achieved a 1.5 times faster maximum speed as well as double the payload compared to the conventional models. In addition, the ultra-small Micro Cylinders are also supported, giving you a greater variety of actuators - ranging from small to large - to choose from.

Maximum speed vs. conventional models
1.5 times faster

Payload vs. conventional models
more than Double

PowerCon supported
RCP5-SA RCP5-RA

Micro Cylinder
RCD-RA

Choice of 6 boards to install

- 1 Pulse motor board
- NEW** 2 Pulse motor board for battery-less absolute specification
- NEW** 3 PowerCon (pulse high-output motor) board
- NEW** 4 PowerCon board for battery-less absolute specification
- 5 24VAC servo motor board
- NEW** 6 Micro Cylinder (BLDC servo motor) board

** Boards 3 and 4 permit operation of only one axis per board.

4 Compatible Field Networks

MSEP-LC MSEP-C

DeviceNet, CC-Link, PROFIBUS-DP, CompoNet, EtherCAT, EtherNet/IP, PROFINET IO and other major field networks are directly accessible.

Features of the network specification

- ▶ 256 positioning points per axis
- ▶ Can be operated by inputting values for target positions and speed
- ▶ Monitor the current position in real time
- ▶ Substantially shorter communications time inside the controller (approx. one-tenth of conventional models)



5 Free Ladder Logic Support Software Is Available from Our Website

MSEP-LC

Ladder logic support software is available for free download from our website. You can create a ladder program before purchasing any product.

Free www.robocylinder.de -> downloads -> software

LC-LADDER

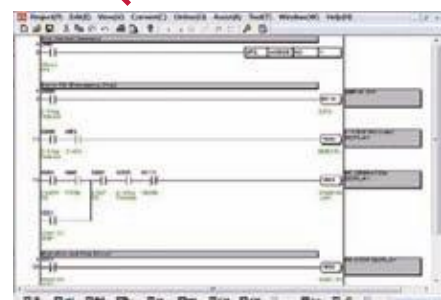

Application Examples

Rear Panel Positioning System

Work parts that have shifted can be realigned during the processing stage of an automotive rear panel by corrective "pushing" by the RoboCylinder. Even when the number of axes increases, a single controller can support them all, making wiring simple.

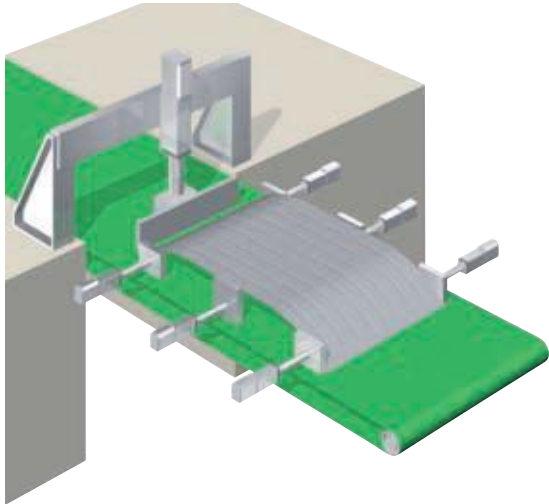

Palletizing System

Thanks to the battery-less absolute encoder, operations can easily be resumed even after an emergency stop or other halts in operation.

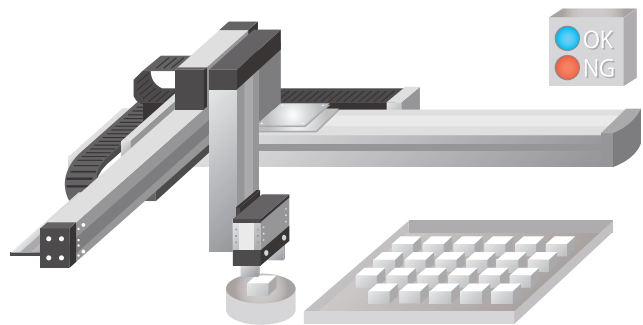

Work Transfer Between Processing Systems

Work parts can be transferred between systems without using a dedicated PLC.

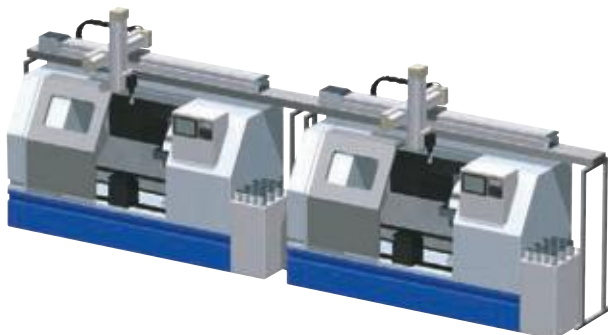

Positioning for Automotive Assembly Lines

In a large-scale assembly line, implementing distributed control of each process and connecting to the host controller via a field network will reduce the load of the host controller.

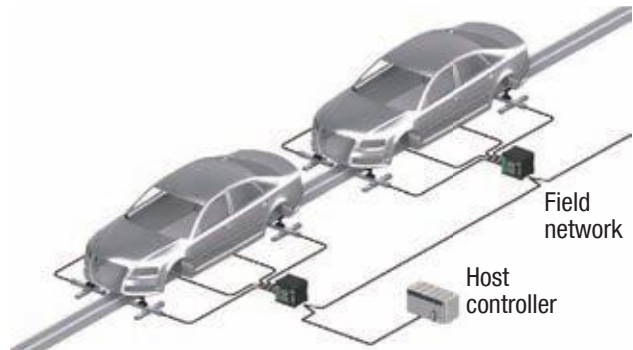

MSEP Controller Models

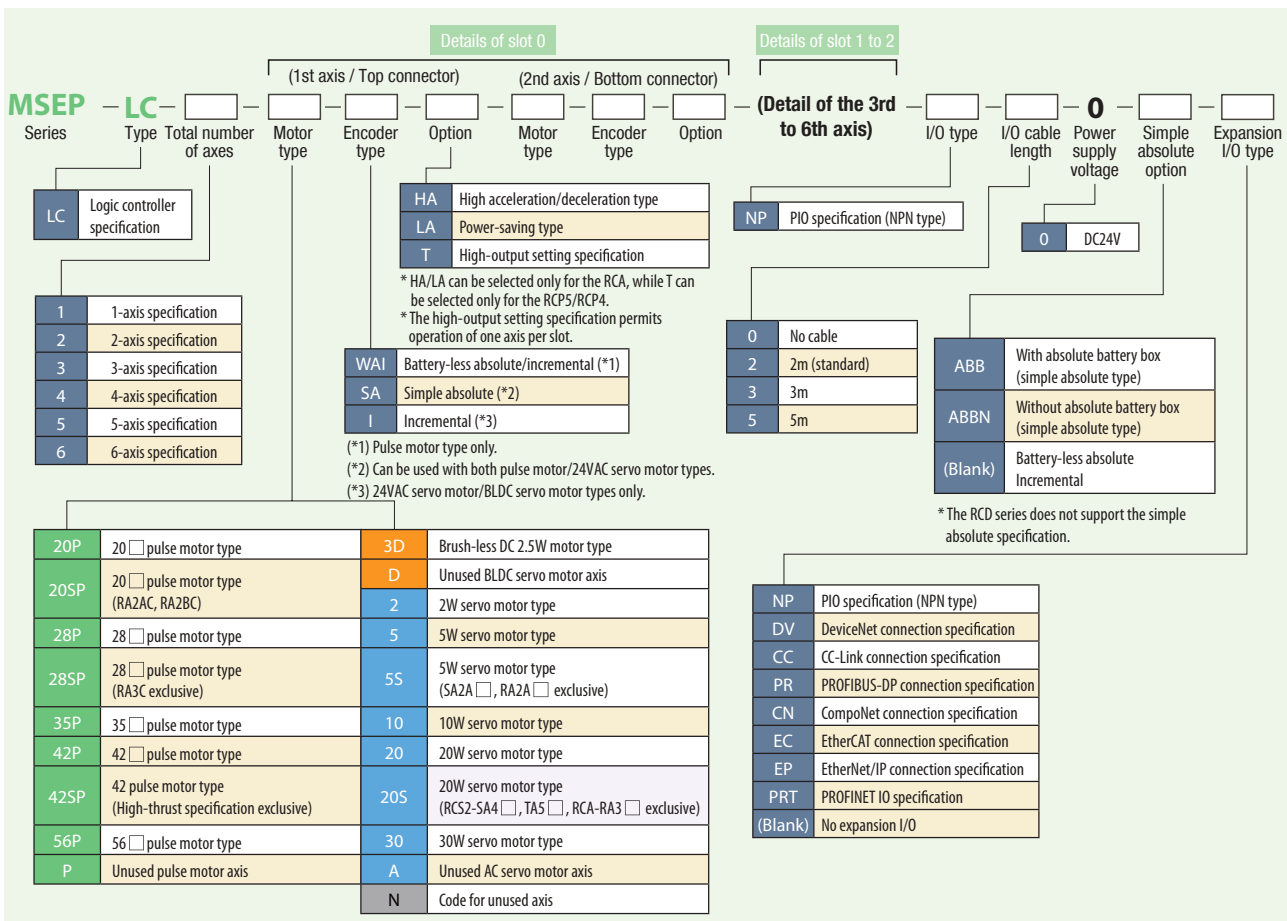
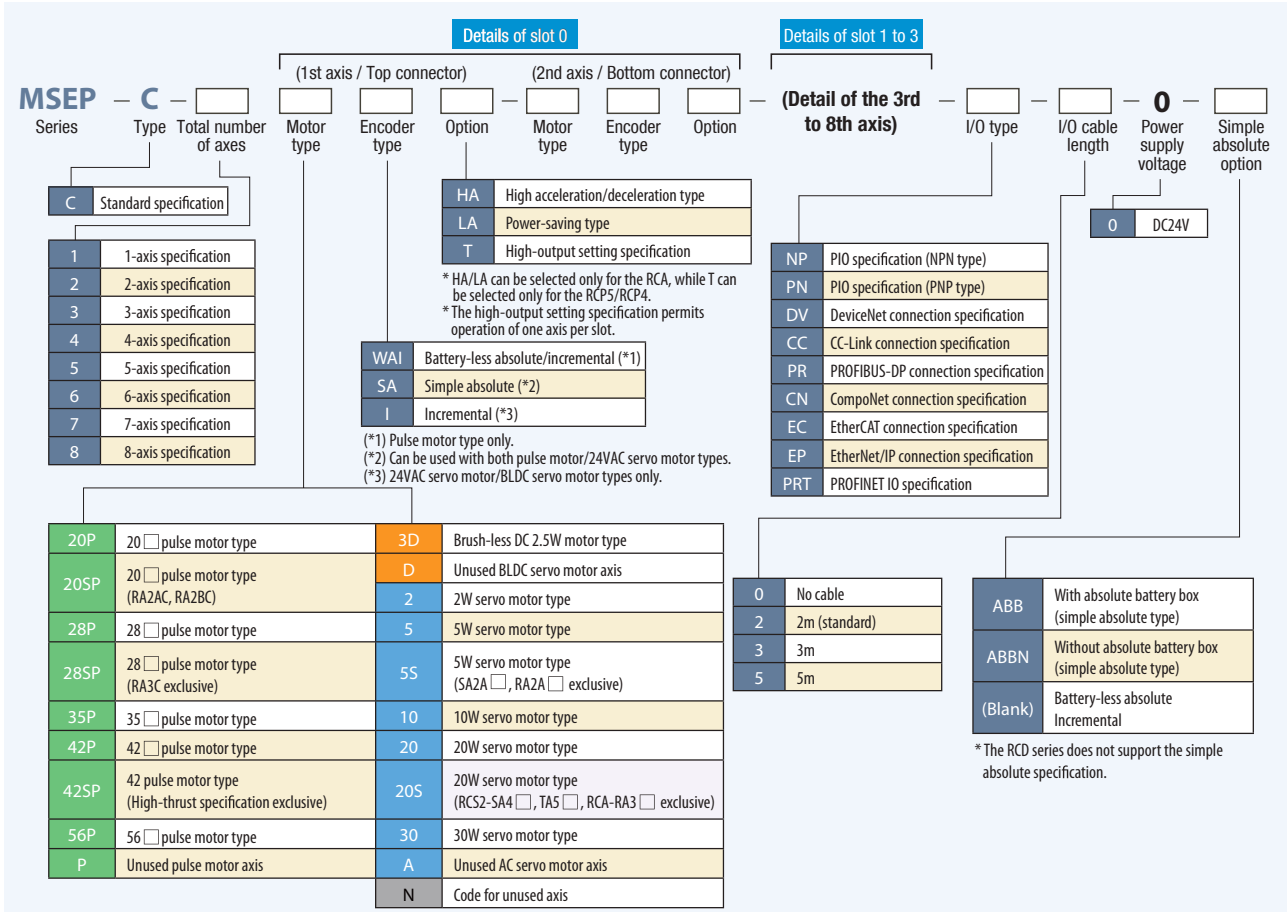

How to Operate the MSEP-C

PIO Specification

Please enter the position data into the MSEP, and designate the position number from the host PLC via PIO in order to operate the actuator.

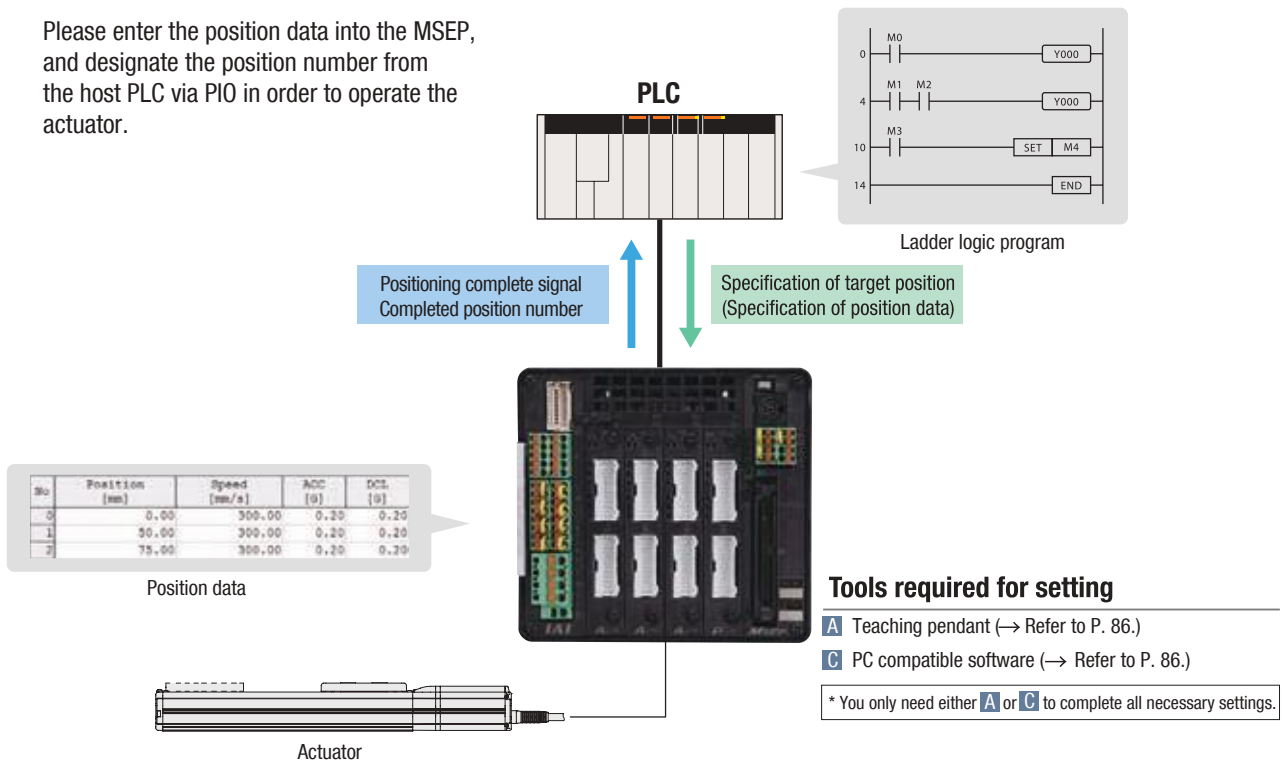

Field Network Specification

- A** Similarly to the PIO specification, please enter the position data into the MSEP, and designate the position number from the host PLC via a field network in order to operate the actuator.
- C** The PLC sends numerical position, speed and other data via a field network to operate the actuator.

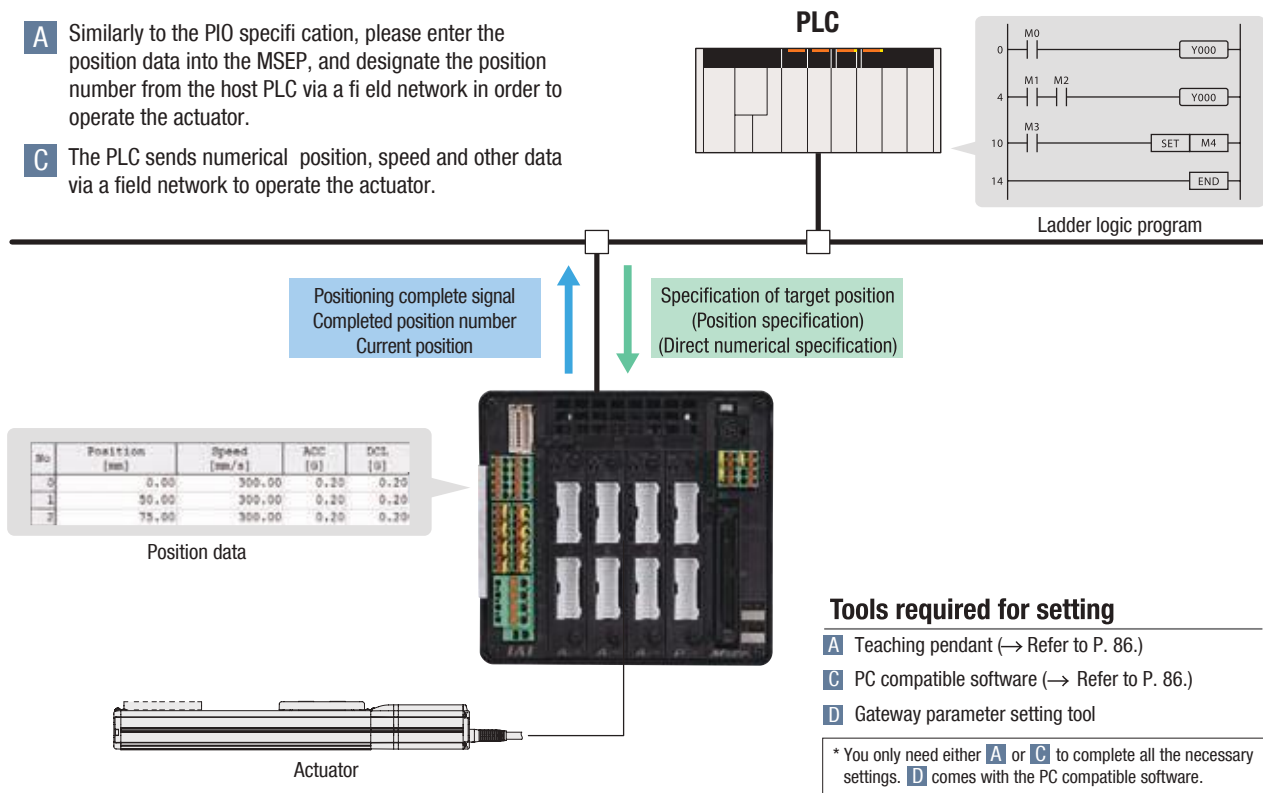

How to Operate the MSEP-LC

PIO Specification

The MSEP-LC runs a ladder logic program internally to operate the axis and control the PIO I/O signals. The axis can be operated either by using position data or specifying coordinates directly.

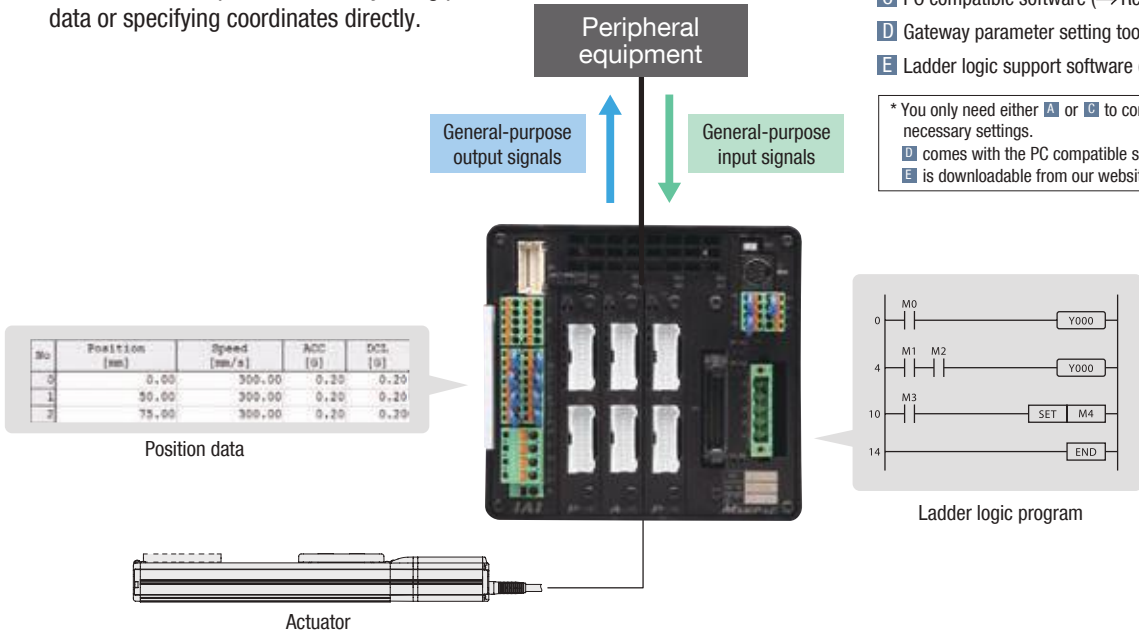

Tools required for setting

- A** Teaching pendant (→ Refer to P. 86.)
- C** PC compatible software (→ Refer to P. 86.)
- D** Gateway parameter setting tool
- E** Ladder logic support software (→ Refer to P. 78.)

* You only need either **A** or **C** to complete all the necessary settings.
D comes with the PC compatible software.
E is downloadable from our website.

Field Network Specification

The MSEP-LC runs a ladder logic program internally to operate the axis and control I/O signals via a network. The axis can be operated either by using position data or specifying coordinates directly.

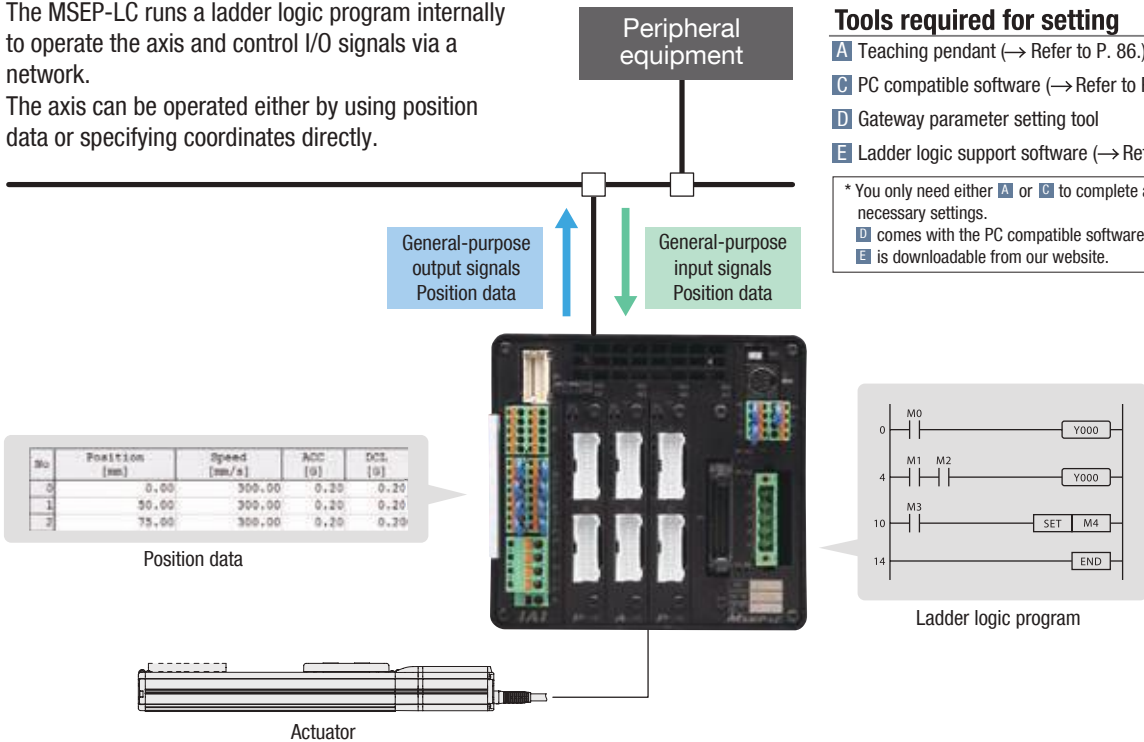

Tools required for setting

- A** Teaching pendant (→ Refer to P. 86.)
- C** PC compatible software (→ Refer to P. 86.)
- D** Gateway parameter setting tool
- E** Ladder logic support software (→ Refer to P. 78.)

* You only need either **A** or **C** to complete all the necessary settings.
D comes with the PC compatible software.
E is downloadable from our website.

Names of the MSEP Controller Components

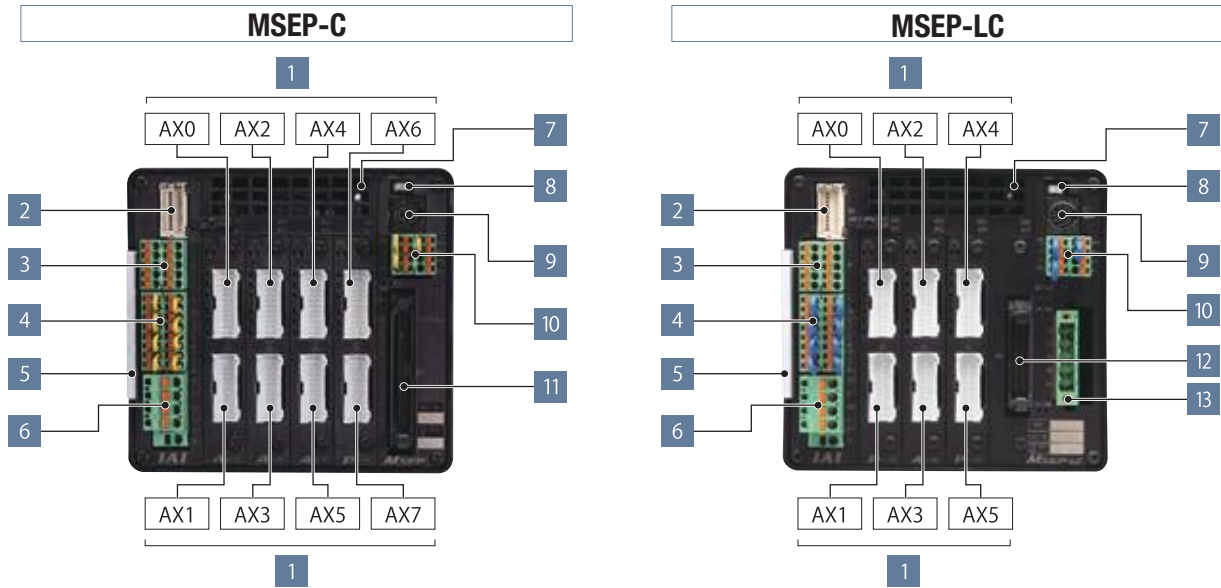

⚠ Caution: With the high-output setting specification (PowerCon), only one axis can be connected per slot.

Descriptions of Each Component

- 1 Motor-encoder connectors for the actuator connection**
Connect motor-encoder cable to the actuator
- 2 Connector for the absolute data backup battery**
Connect the absolute data backup battery if the controller has the absolute position encoder specification
- 3 Connector for the external brake input**
The connector to input a signal to release the brake for the actuator externally.
- 4 Connector for the emergency stop input for power source shut-off**
The emergency stop input connector to connect in/output terminal of the external relay of the motor drive shut-off and each driver slot (*1).
- 5 Information card for configuration of the connecting axes**
The information card contains information regarding the configuration of the controller axes which is removable to examine the contents.
- 6 +24 V power source input connector**
The main power source connector for the controller: Motor drive source shut-down is possible while restoring the power source for the controller unit in case of an emergency shut-down; This is because the terminals for the power source of the motor and the controller are separate.
- 7 Fan unit**
Easily replaceable fan unit. (Replacement fan unit: Model MSEP-FU)
- 8 AUTO/MANUAL switch**
To switch automatic operation to/from manual operation
- 9 SIO connector**
To connect teaching box and the connecting cable for PC software
- 10 System I/O connector**
The connector for remote AUTO/MANU switch input and emergency stop input for the entire controller with functions including an external regeneration-resistance expansion terminal.
- 11 PIO connector/ field network connection connector (MSEP-C only)**
The PIO specification - connects to a 68-pin ribbon I/O cable.
The field network specification - connects to a field network type specified on the MSEP controller.
- 12 Standard I/Os (MSEP-LC only)**
The MSEP-LC comes installed with a 40-pin PIO connector as standard equipment.
- 13 Expansion I/Os (MSEP-LC only)**
Expansion I/Os can be installed as an option.
Available I/O types include PIO, DeviceNet, CC-Link, PROFIBUS-DP, CompoNet, Ethernet/IP, EtherCAT and PROFINET-IO.

(*1) The shut-off feature is available on a single slot basis which is for two axes per slot. Please note that a single axis basis cannot be accommodated.

Input/Output (PIO) Signals

The MSEP-C has dedicated inputs and outputs set to PIO signals at 32 input points/32 output points. The axis operates when each signal is turned ON/OFF from the host PLC.

With the MSEP-LC, general-purpose input/output signals at 32 input points/32 output points can be used in a ladder logic program by using the standard 16 input points/16 output points plus expansion I/Os.

MSEP-C (PIO specification)

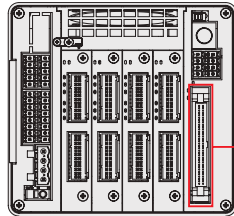

PIO connector

MSEP-LC (Expansion I/O specification)

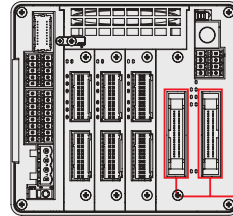

PIO connectors

PIO Wiring Diagram for MSEP-C

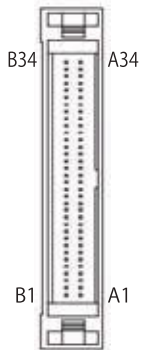

Connector name: HIF6-68PA-1.27DS (Hirose Electric)					
Pin No.	Category	Signal ID	Pin No.	Category	Signal ID
A1	24V	For I/O	A18	Output	OUT0
A2	Input (Axis No. 0)	IN0	A19	Output (Axis No. 0)	OUT1
A3		IN1	A20		OUT2
A4		IN2	A21		OUT3
A5	Input (Axis No. 1)	IN3	A22	Output (Axis No. 1)	OUT4
A6		IN4	A23		OUT5
A7		IN5	A24		OUT6
A8	Input (Axis No. 2)	IN6	A25	Output (Axis No. 2)	OUT7
A9		IN7	A26		OUT8
A10		IN8	A27		OUT9
A11	Input (Axis No. 3)	IN9	A28	Output (Axis No. 3)	OUT10
A12		IN10	A29		OUT11
A13		IN11	A30		OUT12
A14	Input (Axis No. 3)	IN12	A31	Output (Axis No. 3)	OUT13
A15		IN13	A32		OUT14
A16		IN14	A33		OUT15
A17		IN15	A34	OV	For I/O

Connector name: HIF6-68PA-1.27DS (Hirose Electric)					
Pin No.	Category	Signal ID	Pin No.	Category	Signal ID
B1	24V	For I/O	B18	Output	OUT16
B2	Input (Axis No. 4)	IN16	B19	Output (Axis No. 4)	OUT17
B3		IN17	B20		OUT18
B4		IN18	B21		OUT19
B5	Input (Axis No. 5)	IN19	B22	Output (Axis No. 5)	OUT20
B6		IN20	B23		OUT21
B7		IN21	B24		OUT22
B8	Input (Axis No. 6)	IN22	B25	Output (Axis No. 6)	OUT23
B9		IN23	B26		OUT24
B10		IN24	B27		OUT25
B11	Input (Axis No. 7)	IN25	B28	Output (Axis No. 7)	OUT26
B12		IN26	B29		OUT27
B13		IN27	B30		OUT28
B14	Input (Axis No. 7)	IN28	B31	Output (Axis No. 7)	OUT29
B15		IN29	B32		OUT30
B16		IN30	B33		OUT31
B17		IN31	B34	OV	For I/O

PIO Wiring Diagram for MSEP-LC

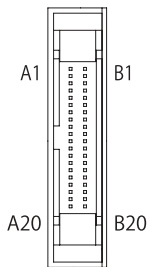

Standard I/Os

Pin No.	Category	Assigned memory	Pin No.	Category	Assigned memory
A1	-	+24-V	A11	Input	X006
A2		external input	A12		X007
A3		Not used	A13		X008
A4		Not used	A14		X009
A5	Input	X000	A15	X00A	
A6		X001	A16	X00B	
A7		X002	A17	X00C	
A8		X003	A18	X00D	
A9		X004	A19	X00E	
A10		X005	A20	X00F	

Pin No.	Category	Assigned memory	Pin No.	Category	Assigned memory
B1	Output	Y000	B11	Output	Y00A
B2		Y001	B12		Y00B
B3		Y002	B13		Y00C
B4		Y003	B14		Y00D
B5		Y004	B15		Y00E
B6		Y005	B16		Y00F
B7		Y006	B17		Not used
B8		Y007	B18		Not used
B9		Y008	B19		0 V external input
B10	Y009	B20			

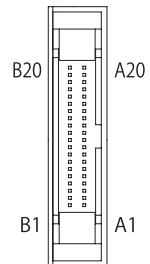

Expansion I/Os

Pin No.	Category	Assigned memory	Pin No.	Category	Assigned memory
A1	-	+24-V	A11	Input	X016
A2		external input	A12		X017
A3		Not used	A13		X018
A4		Not used	A14		X019
A5	Input	X010	A15	X01A	
A6		X011	A16	X01B	
A7		X012	A17	X01C	
A8		X013	A18	X01D	
A9		X014	A19	X01E	
A10		X015	A20	X01F	

Pin No.	Category	Assigned memory	Pin No.	Category	Assigned memory
B1	Output	Y010	B11	Output	Y01A
B2		Y011	B12		Y01B
B3		Y012	B13		Y01C
B4		Y013	B14		Y01D
B5		Y014	B15		Y01E
B6		Y015	B16		Y01F
B7		Y016	B17		Not used
B8		Y017	B18		Not used
B9		Y018	B19		0 V external input
B10	Y019	B20			

Table of General Specifications

Specification item		Description					
Number of axes in the controller		8 axes max. (MSEP-C), 6 axes max. (MSEP-LC)					
Controller/ Motor input power		DC24V ±10%					
Brake power		0.15 A x Number of axes					
Current consumption by control power		0.8A					
Controller inrush current		5A max., under 30 ms					
Motor consumption current	Servo motor type	Rated ampere	Maximum		Pulse motor type	Rated ampere	Maximum
			Energy saver	Stand./Hi-accel.			
	2W	0.8A		4.6A	20P		1.0A
	3W(RCD)	0.7A		1.5A	28P		1.0A
					28SP		1.2A
	5W	1.0A		6.4A	35P		2.0A (High-output incompatible driver)
	10W(RCL)	1.3A		6.4A			
	10W(RCA/RCA2)			2.5A	4.4A	42P	2.2A (High-output disabled)
	20W	1.3A	2.5A	4.4A	56P		3.5A (High-output enabled)
20 W (20S type)	1.7A	3.4A	5.1A				
30W	1.3A	2.2A	4.4A				
Motor inrush current		Slot numbers x 10A max., under 5ms					
Motor-encoder cable length		Maximum length 20m (Note: 10m maximum for simple absolut encoder specification)					
Serial communication (SIO port: dedicated teaching)		RS485 1ch (Modbus protocol compatible) Speed 9.6 to 230.4kbps					
External interface	PIO specification	PIO specification : DC24 V dedicated signal in/output; Maximum input of 4 points/axis; Maximum output of 4 points/axis; Maximum cable length 10m					
	Field network specification	DeviceNet, CC-Link, PROFIBUS-DP, PROFINET IO, CompoNet, EtherCAT, EtherNet/IP					
Data configuration and input method		PC software application, touch panel teaching pendant, gateway parameter configuration tool					
Data retention memory		Restore the position data and parameter in non-volatile memory (unlimited input)					
Positioning points		PIO specification : 2 or 3 points Field network specification: 256 points (no limited input for the simple numerical control and the direct numerical control) (Note) The number of designated positions vary depending on the parameter configuration with motion mode selection.					
LED display (On the front panel)		LED for driver status, 8 LEDs (for each driver board) Status LED, 4 LEDs (PIO specification), 7 LEDs (Fieldbus specification)					
Electromagnetic brake force release		Enable to force-release by transmitting a deactivation signal to each axis (DC24 V input)					
Surge protection		Overcurrent protection (A cut-off semiconductor circuit is built-in on each slot)					
Electric shock protection		Class I basic insulation					
Insulation resistance		DC500V 10 MΩ					
Weight		620g / 690g with the simple absolute encoder specification / 1950g with the absolute data backup battery box (8-axis specification)					
Cooling method		Forced air cooling					
Ambient operating temperature/humidity		0 to 40°C, under 85% RH (non-condensing)					
International Protection code		IP20					
PLC function (MSEP-LC)		Dedicated ladder program (Program capacity: 4k steps)					

Exterior Dimensions

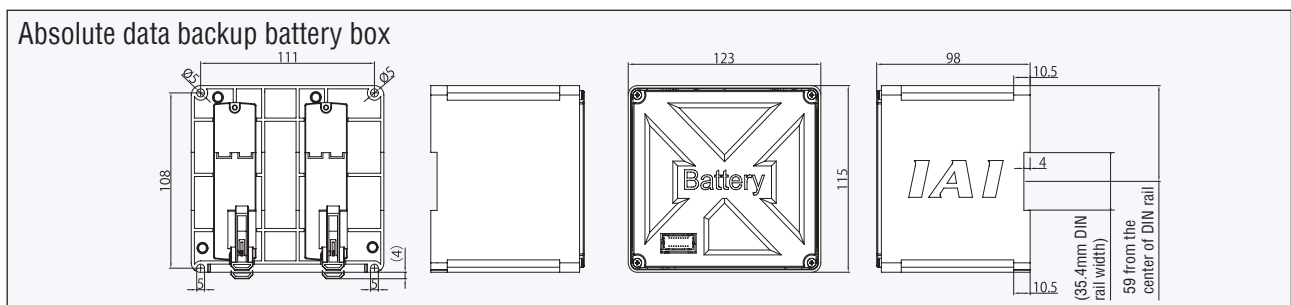
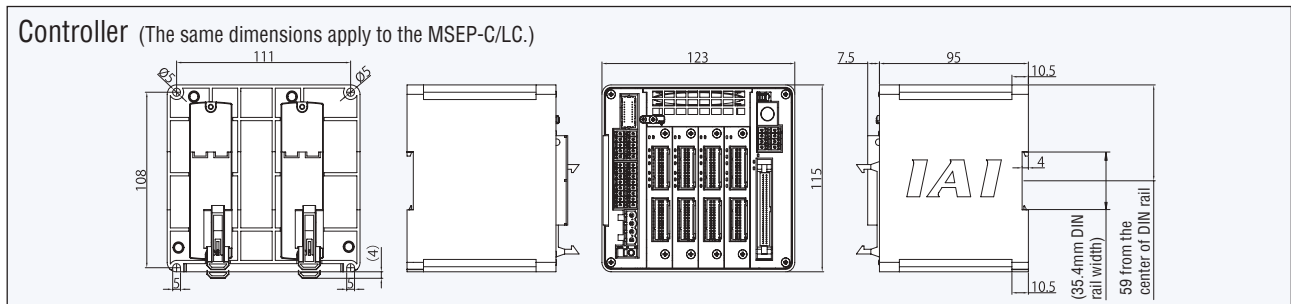

Options

Teaching pendant

Summary Teaching device for positioning input, test operation, and monitoring.

Model **TB-02-C**

Setting



Specification

Rated voltage	24V DC
Power consumption	3.6 W or less (150 mA or less)
Ambient operating temperature	0~40°
Ambient operating humidity	20 to 80%RH (non-condensing)
Environmental resistance	IP20
Weight	470 g (TB-02 unit only)

PC software (Windows only) * For the MSEP field network specification, the PC software is required.

Summary A startup support software for inputting positions, performing test runs, and monitoring. With enhancements for adjustment functions, the startup time is shortened.

Model **RCM-101-MW** (External device communication cable + RS232 conversion unit)

Setting

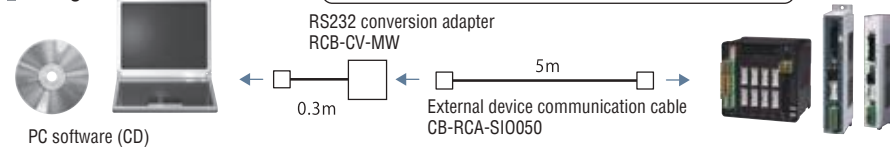

Supported Windows: 2000 SP4 or later / XP SP2 or later / Vista / 7 / 8



Model **RCM-101-USB** (External device communication cable + USB converter adaptor + USB cable)

Setting

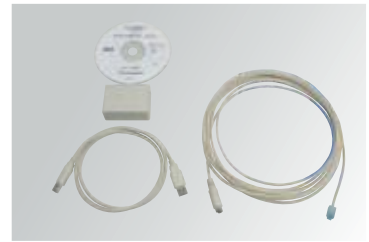
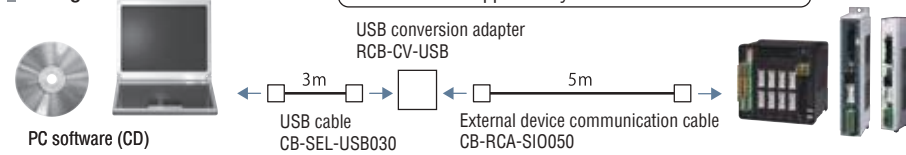

External regeneration resistor

Summary The regeneration resistor converts regenerated current dissipated during deceleration of the motor load into heat. The MSEP controller has an internal regeneration resistor for ordinary operations, however, depending on the operational condition, please install an external regeneration resistor if the internal regeneration resistor capacity is insufficient.

Model **RER-1**

Exterior dimensions

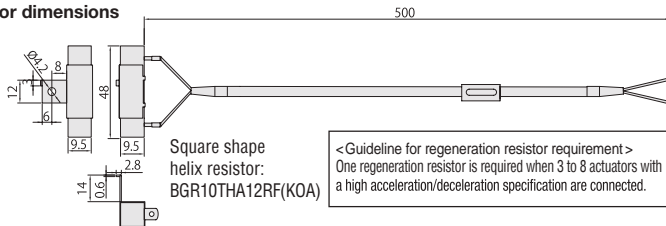

Driver board

Summary A supplement or modification to the driver board is feasible with the MSEP controller. When the actuator that control motions needs to be modified, just replacing the driver board would serve the purpose without changing the entire controller. (The parameters need to be adjusted when changing the driver board)

Model

Motor type	High output type	Encoder type	Number of axes	Model
Pulse motor	High output setting	Battery-less absolute/incremental	1-axis	MSEP-PPD1-W
		Simple absolute	1-axis	MSEP-PPD1-A
		Simple absolute	1-axis	MSEP-PD1-W
	Cancellation of high output setting	Battery-less absolute/incremental	2-axis	MSEP-PD2-W
		Simple absolute	1-axis	MSEP-PD1-A
		Simple absolute	2-axis	MSEP-PD2-A
24VAC servo motor	—	Incremental	1-axis	MSEP-AD1-I
			2-axis	MSEP-AD2-I
		Simple absolute	1-axis	MSEP-AD1-A
			2-axis	MSEP-AD2-A
BLDC servo motor	—	Incremental	1-axis	MSEP-DD1-I
			2-axis	MSEP-DD2-I

Box for the absolute data backup battery

Summary If the absolute position encoder specification is selected with code ABB, the absolute data backup battery box is included with the controller. However, if the battery box is ordered as a separate unit, it does not include the battery but just the box itself. If the battery is needed, please purchase it separately. (Model: AB-7).

Model **MSEP-ABB** (Batteries not included)

Exterior dimensions See P.85

* A cable (Model CB-MSEP-AB005) that connects the absolute data backup battery box to the MSEP is included with the box.

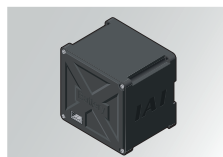

Replacement battery

Summary The replacement battery for the absolute data backup battery box.

Model **AB-7**

Replacement fan unit

Model **MSEP-FU**



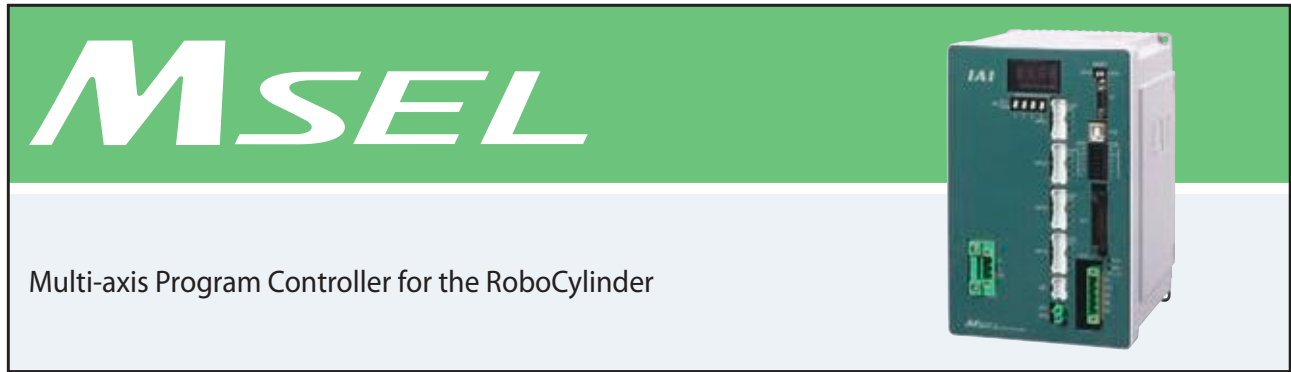

Introducing MSEL, the Multi-axis Program Controller with a High-output Driver (PowerCon) for the RoboCylinder

1 The Pulse Motor Equipped RoboCylinder Controls a Maximum of 4 Axes

Traditionally, up to two pulse motor actuators could be controlled by a program controller. By using MSEL, a maximum of 4 axes can be controlled. Interpolation function is also available, enhancing its range of use.

Example of Combinations

3-axis Cartesian (Pulse Motor)



+

RCP5



A Maximum of 4 Axes Can Be Connected

2 The RoboCylinder RCP5 and RCP4 Can Be Connected

PowerCon drivers make it possible to perform interpolation functions using the high-output RCP5 and RCP4 RoboCylinders, which could not be performed with the traditional PSEL program controller.



3 Significant Enhancements in Programming Functions

Compared to the conventional product (PSEL), we have enhanced the functionality of the MSEL by having 4 times as many programs and 20 times more positions.

	Conventional product PSEL		New product MSEL
Number of programs	64	4 times →	255
Number of program steps	2000	5 times →	9999
Number of multi-tasking programs	8	2 times →	16
Number of positions	1500	20 times →	30000 (*1)

(*1) Note that the number of points available for backup in system memory is 10000 points.

4

Equipped with an Optional Expansion I/O Slot

In addition to the standard I/O (IN 16 points/OUT 16 points), an expansion I/O slot can be filled with either a PIO board (IN 16 points/OUT 16 points) or one of four types of field networks.

	Conventional Product PSEL	New Product MSEL
Max. I/O Input and Output Points	24/8 Not applicable for expansion	32/32 When the expandable slot is used
Field Network	3 types (CC-Link, DeviceNet, PROFIBUS-DP)	4 types (CC-Link, DeviceNet, PROFIBUS-DP, EtherNet/IP)
Other External Connections	RS232C: 1ch	RS232C: 1ch

5

Cable and Cost Reduction

When Controlling 4 Actuator Axes

Conventional Product PSEL 2 units + 24V power supply

New Product MSEL 1 unit

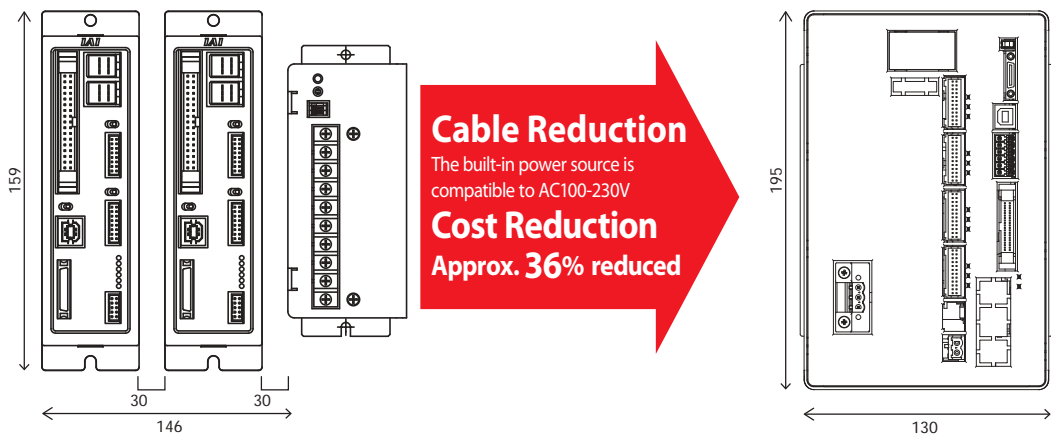

6

Global Version according to CE Safety Standard

MSEL-PG is applicable for Safety Categories B to 3.

(To apply with Safety Category, it is necessary that the user establish a safety circuit out of the controller.)

7

Compatible with Various Models

The MSEL can be connected to a range of pulse motor type RoboCylinders including RCP5/RCP4/RCP3/RCP2.



Service Parts

Model number	CB-CAN-MPA <input type="checkbox"/> <input type="checkbox"/> <input type="checkbox"/>	Integrated Motor-Encoder Cable	for RCP5/RCD
	CB-CAN-MPA <input type="checkbox"/> <input type="checkbox"/> <input type="checkbox"/> - RB	Integrated Motor-Encoder Robot Cable	

* Please indicate cable length (L) in , maximum 20m. e.g.) 080=8m

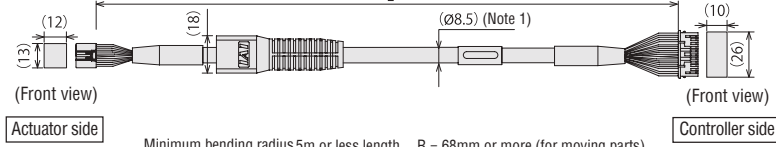

Minimum bending radius 5m or less length R = 68mm or more (for moving parts)
 Longer than 5m R = 73mm or more (for moving parts)

* The robot cable is designed for flex-resistance: Please use the robot cable if the cable has to be installed through the cable track.

(Note 1) If the cable is 5m or longer, Ø9.1 cable diameter applies for a non-robot cable and Ø10 for a robot cable.

Pin No	Signal name	Pin No	Signal name
3	ØA	1	ØA
5	VMM	2	VMM
10	ØB	3	ØB
9	VMM	4	VMM
4	Ø A	5	Ø A
15	Ø B	6	Ø B
8	LS+	7	LS+
14	LS-	8	LS-
12	SA(mABS)	11	SA(mABS)
17	SB(mABS)	12	SB(mABS)
1	A+	13	A+
6	A-	14	A-
11	B+	15	B+
16	B-	16	B-
20	BK+	9	BK+
2	BK-	10	BK-
21	VCC	17	VCC
7	GND	19	GND
18	VPS	18	VPS
13	LS_GND	20	LS_GND
19	—	22	—
22	—(CFVcc)	21	—(CFVcc)
23	—	23	—
24	FG	24	FG

Model number	CB-CFA3-MPA <input type="checkbox"/> <input type="checkbox"/> <input type="checkbox"/>	Integrated Motor-Encoder Cable	for RCP5-RA8C/8R/10C/10R
	CB-CFA3-MPA <input type="checkbox"/> <input type="checkbox"/> <input type="checkbox"/> - RB	Integrated Motor-Encoder Robot Cable	

* Please indicate cable length (L) in , maximum 20m. e.g.) 080=8m

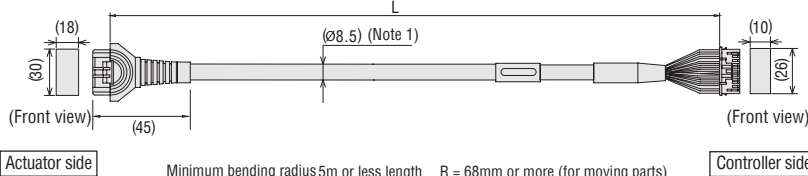

Minimum bending radius 5m or less length R = 68mm or more (for moving parts)
 Longer than 5m R = 73mm or more (for moving parts)

* The robot cable is designed for flex-resistance: Please use the robot cable if the cable has to be installed through the cable track.

(Note 1) If the cable is 5m or longer, Ø9.1 cable diameter applies for a non-robot cable and Ø10 for a robot cable.

Pin No	Signal name	Pin No	Signal name
A1	Ø A	1	Ø A
B1	VMM	2	VMM
A2	Ø A	5	Ø A
B2	Ø B	3	Ø B
A3	VMM	4	VMM
B3	Ø B	6	Ø B
A4	LS+	7	LS+
B4	LS-	8	LS-
A6	SA(mABS)	11	SA(mABS)
B6	SB(mABS)	12	SB(mABS)
A7	A+	13	A+
B7	A-	14	A-
A8	B+	15	B+
B8	B-	16	B-
A5	BK+	9	BK+
B5	BK-	10	BK-
A9	LS_GND	20	LS_GND
B9	VPS	18	VPS
A10	VCC	17	VCC
B10	GND	19	GND
A11	—	21	—
—	—	22	—
—	—	23	—
B11	FG	24	FG

Model number	CB-CA-MPA <input type="checkbox"/> <input type="checkbox"/> <input type="checkbox"/>	Integrated Motor-Encoder Cable	for RCP4
	CB-CA-MPA <input type="checkbox"/> <input type="checkbox"/> <input type="checkbox"/> - RB	Integrated Motor-Encoder Robot Cable	

* Please indicate cable length (L) in , maximum 20m. e.g.) 080=8m

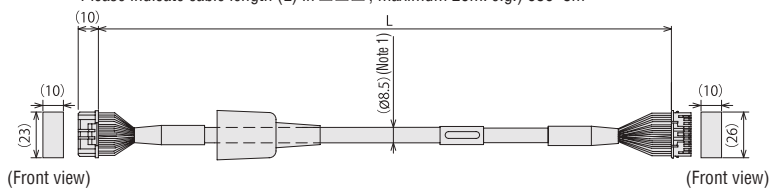

Minimum bending radius 5m or less length R = 68mm or more (for moving parts)
 Longer than 5m R = 73mm or more (for moving parts)

* The robot cable is designed for flex-resistance: Please use the robot cable if the cable has to be installed through the cable track.

(Note 1) If the cable is 5m or longer, Ø9.1 cable diameter applies for a non-robot cable and Ø10 for a robot cable.

Pin No	Signal name	Pin No	Signal name
A1	ØA/U	1	ØA/U
B1	VMM/V	2	VMM/V
A2	ØA/W	5	ØA/W
B2	ØB/-	3	ØB/-
A3	VMM/-	4	VMM/-
B3	ØB/-	6	ØB/-
A4	LS+/BK+	7	LS+/BK+
B4	LS-/BK-	8	LS-/BK-
A6	-/A+	11	-/A+
B6	-/A-	12	-/A-
A7	A+/B+	13	A+/B+
B7	A-/B-	14	A-/B-
A8	B+/Z+	15	B+/Z+
B8	B-/Z-	16	B-/Z-
A5	BK+/LS+	9	BK+/LS+
B5	BK-/LS-	10	BK-/LS-
A9	LS_GND	20	LS_GND
B9	VPS	18	VPS
A10	VCC	17	VCC
B10	GND	19	GND
A11	—	21	—
—	—	22	—
—	—	23	—
B11	FG	24	FG

Model number	CB-APSEP-MPA <input type="checkbox"/> <input type="checkbox"/> <input type="checkbox"/> - LC	Integrated Motor-Encoder Cable	for RCP3/RCA2 and others
	CB-APSEP-MPA <input type="checkbox"/> <input type="checkbox"/> <input type="checkbox"/>	Integrated Motor-Encoder Robot Cable	

* Please indicate cable length (L) in , maximum 20m. e.g.) 080=8m

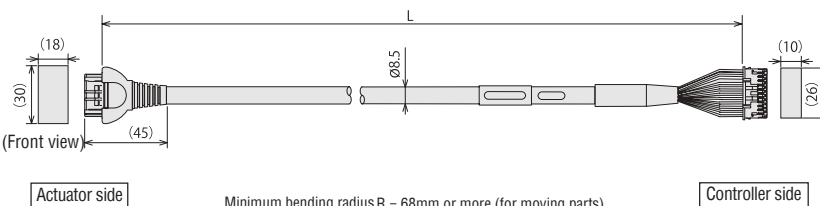

Minimum bending radius R = 68mm or more (for moving parts)

* The robot cable is designed for flex-resistance: Please use the robot cable if the cable has to be installed through the cable track.

Actuator side		Controller side
Pin number		Pin number
A1	(PCON) (ACON)	1
B1	(ØA) (U)	2
A2	(VMM) (V)	3
B2	(ØA) (W)	4
A3	(ØB) (-)	5
B3	(VMM) (-)	6
A4	(ØB) (-)	7
B4	(LS+) (BK+)	8
A6	(-) (A+)	9
B6	(-) (A-)	10
A7	(+) (B+)	11
B7	(-) (B-)	12
A8	(+) (Z+)	13
B8	(-) (Z-)	14
A5	(BK+) (LS+)	15
B5	(BK-) (LS-)	16
A9	(GNDLS) (GNDLS)	17
B9	(VPS) (VPS)	18
A10	(VCC) (VCC)	19
B10	(GND) (GND)	20
A11	NC	21
B11	Shield (FG) (FG)	22
	NC	23
	NC	24

Model number **CB-PSEP-MPA** **Integrated Motor-Encoder Robot Cable** **for RCP2**

* Please indicate cable length (L) in , maximum 20m. e.g.) 080=8m

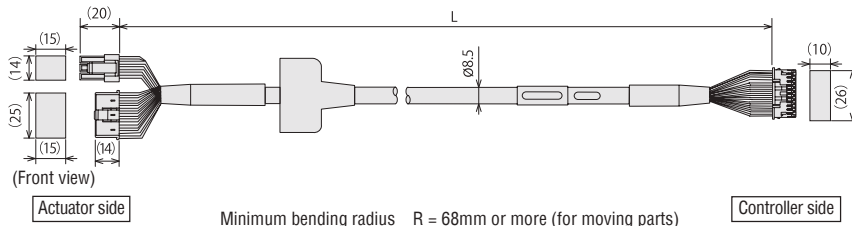

Actuator side Pin number		Controller side Pin number
1	(ØA)	1
2	(VMM)	2
4	(ØB)	3
5	(VMM)	4
6	(ØA)	5
8	(ØB)	6
16	(BK+)	9
17	(BK-)	10
5	NC	11
6	NC	12
13	(LS+)	7
14	(LS-)	8
1	(A+)	13
2	(A-)	14
3	(B+)	15
4	(B-)	16
10	(VCC)	17
11	(VPS)	18
9	(GND)	19
12	(Spare)	20
15	NC	21
7	NC	22
8	NC	23
18	Shield (FG)	24

Model number **CB-RPSEP-MPA** **Integrated Motor-Encoder Robot Cable** **for RCP2-RTBS/RTBSL/RTCS/RTCSL**

* Please indicate cable length (L) in , maximum 20m. e.g.) 080=8m

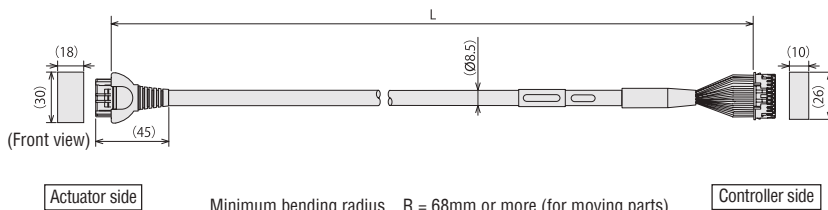

Actuator side Pin number		Controller side Pin number
A1	(ØA)	1
B1	(VMM)	2
A2	(ØA)	5
B2	(ØB)	3
A3	(VMM)	4
B3	(ØB)	6
A6	(LS+)	7
B6	(LS-)	8
A7	(A+)	13
B7	(A-)	14
A8	(B+)	15
B8	(B-)	16
A4	NC	—
B4	NC	—
A5	(BK+)	9
B5	(BK-)	10
A9	(GNDLS)	20
B9	(VPS)	18
A10	(VCC)	17
B10	(GND)	19
A11	NC	21
B11	Shield (FG) (FG)	24
	NC	22
	NC	23

Model number **CB-ASEP-MPA** **Integrated Motor-Encoder Robot Cable** **for RCA**

* Please indicate cable length (L) in , maximum 20m. e.g.) 080=8m

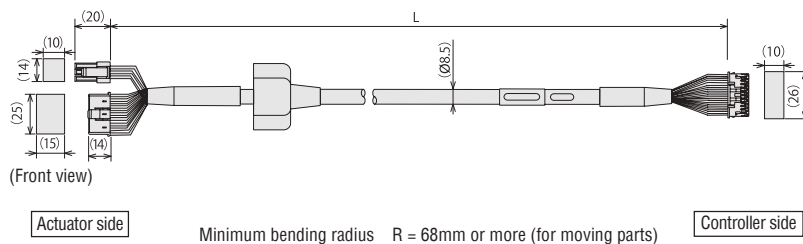

Actuator side Pin number		Controller side Pin number
1	(U)	1
2	(V)	2
	NC	3
3	(W)	4
	NC	5
18	(BK+)	7
17	(BK-)	8
16	(LS+)	10
1	(A+)	11
2	(A-)	12
3	(B+)	13
4	(B-)	14
10	(Z+)	15
11	(Z-)	16
14	(VCC)	17
13	(VPS)	18
15	(GND)	19
6	(Spare)	20
5	NC	21
8	NC	22
12	NC	23
9	Shield (FG)	24

Model number **CB-MSEP-PIO** **PIO Flat Cable** **for MSEP-C**

* Please indicate cable length (L) in , maximum 10m. e.g.) 020=2m

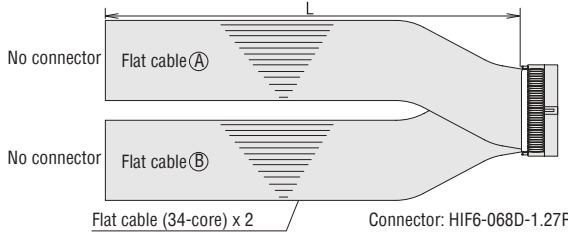

No.	Cable color	Wiring	No.	Cable color	Wiring	No.	Cable color	Wiring	No.	Cable color	Wiring
A1	Brown-1		A18	Gray-2		B1	Brown-5		B18	Gray-6	
A2	Red-1		A19	White-2		B2	Red-5		B19	White-6	
A3	Orange-1		A20	Black-2		B3	Orange-5		B20	Black-6	
A4	Yellow-1		A21	Brown-3		B4	Yellow-5		B21	Brown-6	
A5	Green-1		A22	Red-3		B5	Green-5		B22	Red-6	
A6	Blue-1		A23	Orange-3		B6	Blue-5		B23	Orange-6	
A7	Purple-1		A24	Yellow-3		B7	Purple-5		B24	Yellow-6	
A8	Gray-1		A25	Green-3		B8	Gray-5		B25	Green-6	
A9	White-1		A26	Blue-3		B9	White-5		B26	Blue-6	
A10	Black-1		A27	Purple-3		B10	Black-5		B27	Purple-6	
A11	Brown-2		A28	Gray-3		B11	Brown-5		B28	Gray-6	
A12	Red-2		A29	White-3		B12	Red-5		B29	White-6	
A13	Orange-2		A30	Black-3		B13	Orange-5		B30	Black-6	
A14	Yellow-2		A31	Brown-4		B14	Yellow-5		B31	Brown-6	
A15	Green-2		A32	Red-4		B15	Green-5		B32	Red-6	
A16	Blue-2		A33	Orange-4		B16	Blue-5		B33	Orange-6	
A17	Purple-2		A34	Yellow-4		B17	Purple-5		B34	Yellow-6	

Model number **CB-PAC-PIO** **PIO Flat Cable** **for PCON-CA/MSEP-LC**

* Please indicate cable length (L) in , maximum 10m. e.g.) 020=2m

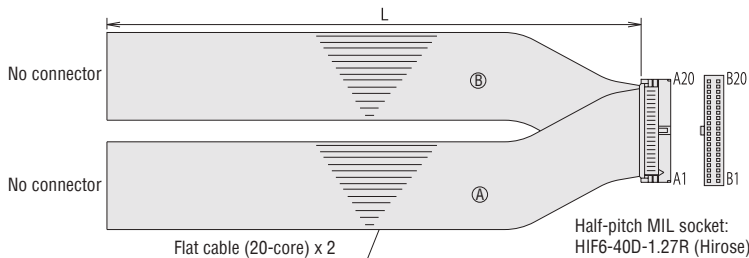

No.	Signal name	Cable color	Wiring	No.	Signal name	Cable color	Wiring
A1	24V	Brown-1		B1	OUT0	Brown-3	
A2	24V	Red-1		B2	OUT1	Red-3	
A3	—	Orange-1		B3	OUT2	Orange-3	
A4	—	Yellow-1		B4	OUT3	Yellow-3	
A5	IN0	Green-1		B5	OUT4	Green-3	
A6	IN1	Blue-1		B6	OUT5	Blue-3	
A7	IN2	Purple-1		B7	OUT6	Purple-3	
A8	IN3	Gray-1		B8	OUT7	Gray-3	
A9	IN4	White-1		B9	OUT8	White-3	
A10	IN5	Black-1		B10	OUT9	Black-3	
A11	IN6	Brown-2		B11	OUT10	Brown-4	
A12	IN7	Red-2		B12	OUT11	Red-4	
A13	IN8	Orange-2		B13	OUT12	Orange-4	
A14	IN9	Yellow-2		B14	OUT13	Yellow-4	
A15	IN10	Green-2		B15	OUT14	Green-4	
A16	IN11	Blue-2		B16	OUT15	Blue-4	
A17	IN12	Purple-2		B17	—	Purple-4	
A18	IN13	Gray-2		B18	—	Gray-4	
A19	IN14	White-2		B19	OV	White-4	
A20	IN15	Black-2		B20	OV	Black-4	

**RCP5/RCP5CR Series V7
Slider / Rod Type
Catalogue No. 1115-E**



The information contained in this catalog is subject to change without notice for the purpose of product improvement



IAI Industrieroboter GmbH

Ober der Röth 4

D-65824 Schwalbach / Frankfurt

Germany

Tel.: +49-6196-8895-0

Fax: +49-6196-8895-24

E-Mail: info@IAI-GmbH.de

Internet: <http://www.eu.IAI-GmbH.de>

IAI America, Inc.

2690 W. 237th Street, Torrance, CA 90505, U.S.A

Phone: +1-310-891-6015, Fax: +1-310-891-0815

IAI (Shanghai) Co., Ltd

Shanghai Jiahua Business Center A8-303, 808,

Hongqiao Rd., Shanghai 200030, China

Phone: +86-21-6448-4753, Fax: +86-21-6448-3992

IAI CORPORATION

577-1 Obane, Shimizu-Ku, Shizuoka, 424-0103 Japan

Phone: +81-543-64-5105, Fax: +81-543-64-5192

IAI Robot (Thailand) Co., Ltd

825 PhairojKijja Tower 12th Floor, Bangna-Trad RD.,

Bangna, Bangna, Bangkok 10260, Thailand

Phone: +66-2-361-4457, Fax: +66-2-361-4456