

Dust-proof/Splash-proof

ROBO CYLINDER® RCP4W series

RCP4W

**ROBO
CYLINDER**



A First for Slider-type ROBO Cylinders!

Dust-proof/Splash-proof Performance of IP65, Plus At-will Installation Configuration Flexibility

Features

1 Dust-proof/Splash-proof Performance of IP65

A special structure where the base is positioned upside down to position the opening at the bottom which achieves high dust-proof/splash-proof performance of IP65 for the first time with slider-type ROBO Cylinders.









IP Marking

IP

- First digit**
Protection against the human body and solid objects
- Second digit**
Protection against the intrusion of water



IP Classes

IP class		Description	Applicable IAI products
IP67	Solid objects	Fully protected against the entry of powder dust into the equipment.	 Slider type RCP2W-SA16C
	Water	Even when the equipment is submerged in water, water does not enter the equipment.	
IP65	Solid objects	Fully protected against the entry of powder dust into the equipment.	 Slider type RCP4W  Slider type ISWA/ISPWA  Pulse motor rod type RCP2W-RA4C/RA6C  SCARA robot IX-NNW
	Water	The equipment receives no harmful effect even when directly hit by water jets from any direction.	
IP54	Solid objects	Dust that would affect the operation of the equipment does not enter the equipment.	 High-thrust rod type RCP2W-RA10C  24-V servo motor rod type RCAW-RA3/RA4 200-V servo motor rod type RCS2W-RA4
	Water	The equipment receives no harmful effect even when contacted by water splashes from any direction.	
IP50	Solid objects	Dust that would affect the operation of the equipment does not enter the equipment.	 Small gripper (dust-proof type) RCP2W-GR
	Water	The equipment is not protected against water.	



2

Compact

IAI's splash-proof single-axis robots (ISWA series) have been made smaller to approx. 60% in cross-section area ratio while keeping the excellent splash-proof performance of ISWA robots. (60% is based on comparison of ISWA-S and RCP4W-SA5C)

	ISWA			RCP4W		
	Type L	Type M	Type S	SA7C	SA6C	SA5C
	(Actuator width)	(Actuator width)	(Actuator width)	(Actuator width)	(Actuator width)	(Actuator width)
Stroke (mm)	100 to 1200 (Available in 50 increments)	100 to 1000 (Available in 50 increments)	100 to 600 (Available in 50 increments)	100 to 700 (Available in 50 increments)	100 to 600 (Available in 50 increments)	100 to 500 (Available in 50 increments)
Maximum speed (mm/s)	1000	1000	800	530	400	330

3

Mount on the Wall or Hang from the Ceiling

Wall-mounting brackets and ceiling-mounting brackets are available as options, which significantly increase the freedom of installation.

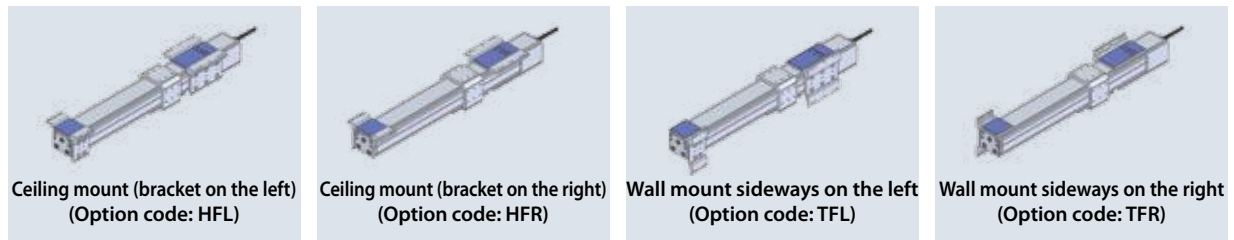

4

Installable on All Four Sides of the Top, Bottom, Left and Right of the Table

The table, positioned in a manner wrapping around the actuator, has tapped holes on all four sides of the top, bottom, left and right to increase the freedom of actuator installation.

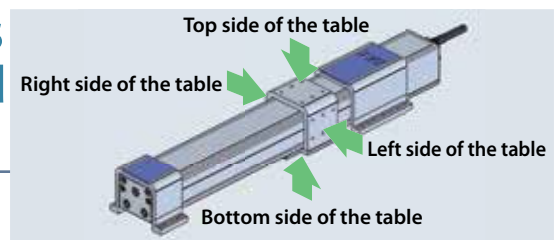

5

Choice of Grease

You can select either industrial grease (Daphne Eponex No. 2) (standard) or food grade grease (Medallion FM No. 1) for the guides and ball screw in the actuator.

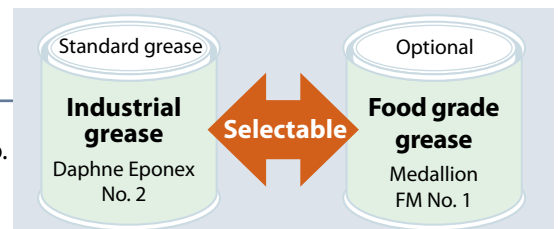

Specification List

Take note that, with the RCP4W series, the horizontal payload, the dynamic allowable moments, the overhang load length and the maximum stroke vary depending on whether the actuator is operated with its brackets on both ends fixed (both ends fixed) or with only the motor-side mounting bracket fixed in a cantilever configuration (cantilever).

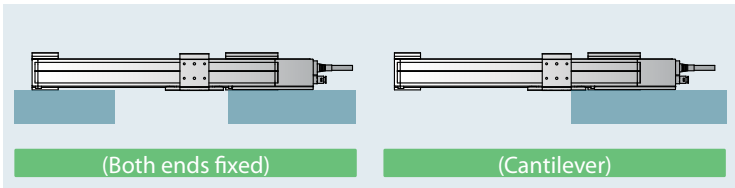

Base Specifications (Both Ends Fixed)

Series	Type	Actuator width (mm)	Motor type	Ball screw lead (mm)	Maximum speed (mm/s)	Acceleration (G)		Horizontal payload (kg)		Positioning repeatability (mm)	Dynamic allowable moment (N·m)			Overhang load length (mm)	Stroke (mm)	Page
						Rated	Maximum	Rated acceleration	Maximum acceleration		Ma	Mb	Mc			
RCP4W	SA5C	55	35 □	10	330	0.3	0.6	5	2	±0.02	3.4	4.9	8	125	100 to 500 (Available in 50-mm increments)	P5
				5	165			10	4							
	SA6C	62	42 □	12	400			7.5	3		4.7	6.7	11			
				6	200			15	6							
	SA7C	77	56 □	16	530			10	4		6.1	8.8	16.8			
				8	265			20	8							

Cantilever

Series	Type	Actuator width (mm)	Motor type	Ball screw lead (mm)	Maximum speed (mm/s)	Acceleration (G)		Horizontal payload (kg)		Positioning repeatability (mm)	Dynamic allowable moment (N·m)			Overhang load length (mm)	Stroke (mm)	Page
						Rated	Maximum	Rated acceleration	Maximum acceleration		Ma	Mb	Mc			
RCP4W	SA5C	55	35 □	10	330	0.3	0.6	1.5	0.5	±0.02	1.7	2.5	4	75	150 max.	P5
				5	165			2	1							
	SA6C	62	42 □	12	400			3	1.5		2.4	3.4	5.5			
				6	200			4.5	2.5							
	SA7C	77	56 □	16	530			4.5	3		3.1	4.4	8.4			
				8	265			7	4							

System Configuration * For details on each device, refer to the RCP4 catalog.

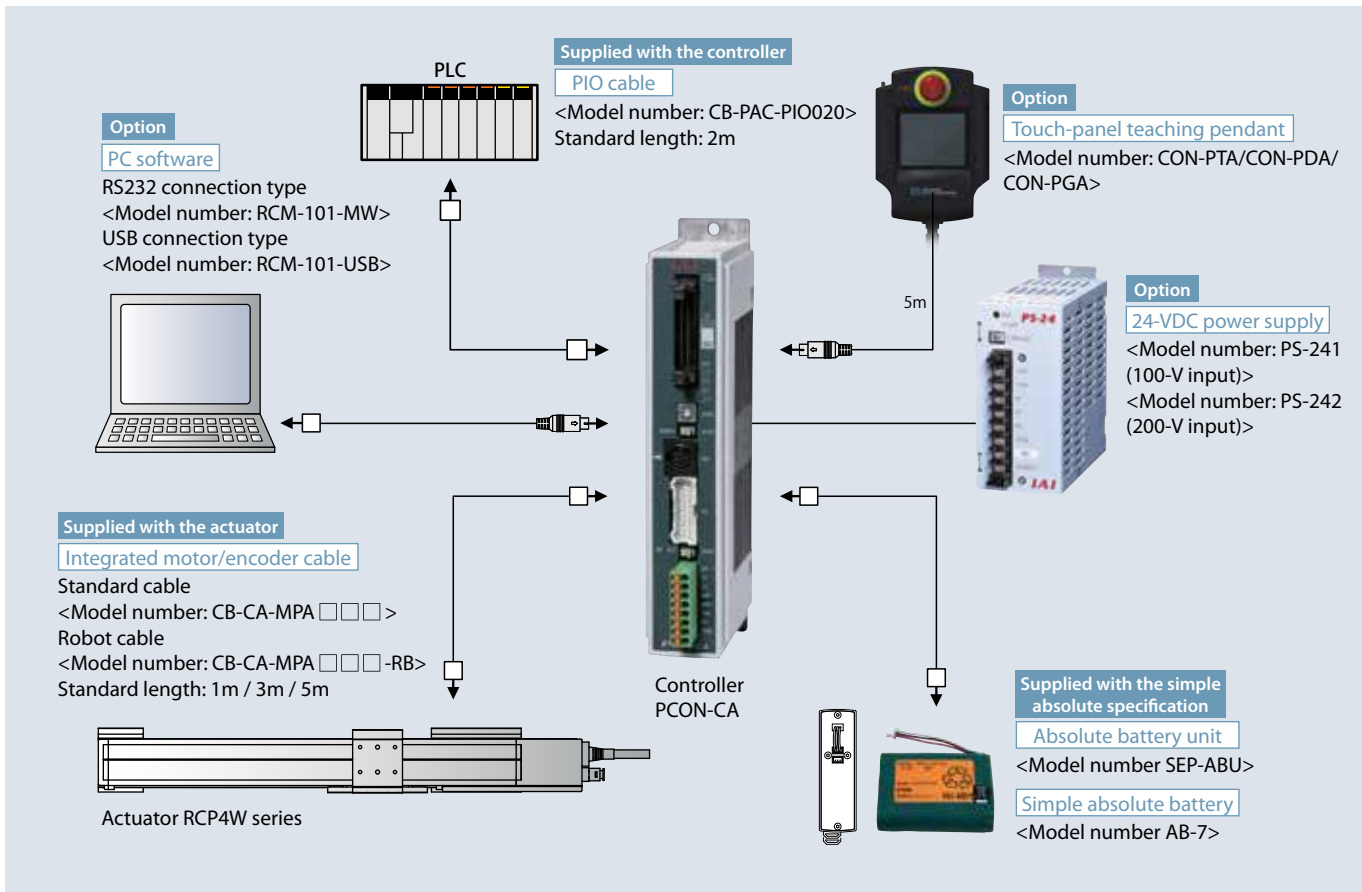

Model number

Actuator

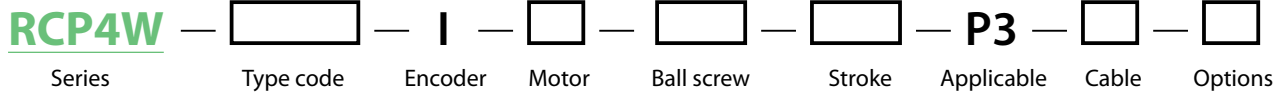

SA5C	Actuator width 55 mm
SA6C	Actuator width 62 mm
SA7C	Actuator width 77 mm

I	Incremental
---	-------------

35P	35 □ motor
42P	42 □ motor
56P	56 □ motor

5	Lead 5
6	Lead 6
8	Lead 8
10	Lead 10
12	Lead 12
16	Lead 16

100	100mm
?	?
700	700mm

(Can be set in 50-mm increments.)

P3	PCON-CA
----	---------

N	No cable
P	1 m
S	3 m
M	5 m
X □	Length designation
R □ □	Robot cable

A1	Cable exit from the left
A3	Cable exit from the right
AL	Additional alumite coating
GE	Food grade grease (edible grease)
NM	Non-motor side specification
HFL	Ceiling mount (left)
HFR	Ceiling mount (right)
TFL	Wall mount sideways on the left
TFR	Wall mount sideways on the right

Actuator Options

Optional Cable Exit Direction Code: A1, A3

You can select one of the following three cable exit directions. If no direction is specified, the cable is exited from the rear.



Exit from the rear (standard)

Option code: (Blank)



Exit from the left side face

Option code: A1



Exit from the right side face

Option code: A3

Additional Alumite Coating Code: AL

The actuator is coated with alumite, but alumite has been removed in the machined areas of the table and front/rear mounting brackets. This option adds alumite coating to these areas. (This option is recommended if the actuator will come in contact with water.)

Food Grade Grease (Edible Grease) Code: GE

Normally industrial grease is applied to the guides and ball screw of the actuator. You can change this grease to food grade grease (edible grease).

Non-motor side Specification Code: NM

You can change the normal slider position of the actuator (motor side) to the non-motor side.

Actuator Mounting Bracket Code: HFL, HFR, TFL, TFR

You can change the bracket for securing the actuator so that the actuator can be installed directly on the ceiling or wall surface (left or right).

* Right and left of the wall mount represent the directions as viewed from the motor side. Refer to P. 11 and 12 for detailed drawings.

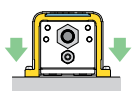

Horizontal mount (standard)

Option code: (Blank)

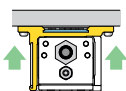

Ceiling mount (bracket installed on the left)

Option code: HFL

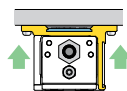

Ceiling mount (bracket installed on the right)

Option code: HFR

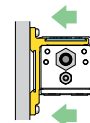

Wall mount sideways on the left

Option code: TFL

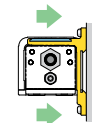

Wall mount sideways on the right

Option code: TFR

Handling Precautions

1. This actuator cannot be used in applications where it comes in direct contact with food which will be sold.
2. Keep the acceleration/deceleration at or below the maximum value. If the actuator is operated beyond the maximum acceleration/deceleration (0.6 G), abnormal noise/vibration, failure or shorter life may result.
3. Keep the allowable load moments and overhang load length within the allowable values. If the actuator is operated beyond the allowable values, abnormal noise/vibration, failure or shorter life may result.
4. The actuator must be installed horizontally. It can be hung from the ceiling or mounted on the wall only when a dedicated bracket is used.
5. If the actuator is used in an environment subject to powder dust or water splashes, supply air from the air supply port provided on the rear of the actuator (air purge). For the amount of air to be supplied, etc., refer to the page of the specific model.
6. Consult IAI on a special environment (such as when a chemical coolant other than water is used).

RCP4W-SA5C

ROBO Cylinder
Pulse motor

Splash-proof slider type
Coupling specification

Actuator width: 55 mm

Model Specification Items

RCP4W — **SA5C** — **I** — **35P** — — — **P3** — —

Series — Type — Encoder type — Motor type — Lead — Stroke — Applicable controller — Cable length — Options

I: Incremental specification
* Also select code "I" for the simple absolute specification.

35P: Pulse motor size 35

10: 10mm
5: 5mm

100 : 100mm
500 : 500mm
(Can be set in 50-mm increments.)

P3: PCON-CA
* The RCP4W can be operated only with the PCON-CA

N: None
P: 1 m
S: 3 m
M: 5 m
X : Length designation
R : Robot cable

Refer to the option list below.



■ Payload by Acceleration/Deceleration

With the RCP4W series, the payload remains the same even when the speed is raised. However, the payload will drop if the acceleration is raised. Check on the table below.

Diagram of Acceleration/Deceleration vs. Payload [Supported at Both Ends]

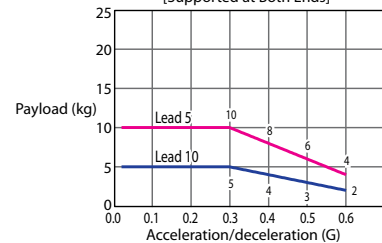
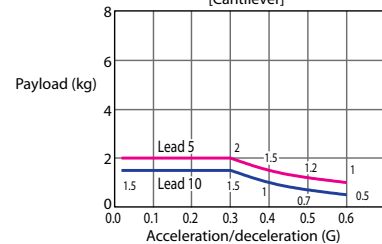

Diagram of Acceleration/Deceleration vs. Payload [Cantilever]



- (1) This actuator is designed exclusively for horizontal installation. It cannot be installed vertically. When hanging the actuator from the ceiling or mounting it on the wall, be sure to do so using an optional dedicated bracket.
- (2) The payload varies depending on the acceleration/deceleration. The upper limit of acceleration/deceleration is 0.6 G.
- (3) The cable joint connector is not splash-proof, so install the connector in a location where it will not come in contact with water.
- (4) Refer to the page at right for the air tube length and air flow rate when implementing air purge.

Actuator Specifications

■ Leads and Payloads

Model number	Lead (mm)	Maximum horizontal payload (kg)		Maximum push force (N)	Positioning repeatability (mm)	Stroke (mm)
		Supported on both ends	Cantilever			
RCP4W-SA5C-I-35P-10-①-P3-②-③	10	5	1.5	66.9	±0.02	100 to 500 (in 50-mm increments)
RCP4W-SA5C-I-35P-5-①-P3-②-③	5	10	2	147.9		

Legend ① Stroke ② Cable length ③ Options

■ Stroke and Maximum Speed

Lead	Stroke	100 to 500 (in 50-mm increments)
		10
5		165

(unit: mm/s)

① Stroke

Stroke (mm)	Standard price
100	-
150	-
200	-
250	-
300	-
350	-
400	-
450	-
500	-

② Options

Name	Option code	See page	Standard price
Cable exit from the left side face	A1	→P4	-
Cable exit from the right side face	A3	→P4	-
Additional alumite coating	AL	→P4	-
Food grade grease (edible grease)	GE	→P4	-
Non-motor side specification	NM	→P4	-
Ceiling mount (bracket mounted on the left)	HFL	→P4	-
Ceiling mount (bracket mounted on the right)	HFR	→P4	-
Wall mount sideways on the left	TFL	→P4	-
Wall mount sideways on the right	TFR	→P4	-

③ Cable length

Type	Cable symbol	Standard price
Standard type	P(1m)	-
	S(3m)	-
	M(5m)	-
Special length	X06(6m) ~ X10(10m)	-
	X11(11m) ~ X15(15m)	-
	X16(16m) ~ X20(20m)	-
Robot cable	R01(1m) ~ R03(3m)	-
	R04(4m) ~ R05(5m)	-
	R06(6m) ~ R10(10m)	-
	R11(11m) ~ R15(15m)	-
	R16(16m) ~ R20(20m)	-

Actuator Specifications

Item	Description
Drive system	Ball screw φ8 mm, rolled C10
Positioning repeatability	±0.02mm
Lost motion	0.1 mm or less
Static allowable moment	Supported on both ends: Ma: 5.9 N·m Mb: 8.4 N·m Mc: 13.7 N·m
	Cantilever: Ma: 2.9 N·m Mb: 4.2 N·m Mc: 6.8 N·m
Dynamic allowable moment (*)	Supported on both ends: Ma: 3.4 N·m Mb: 4.9 N·m Mc: 8.0 N·m
	Cantilever: Ma: 1.7 N·m Mb: 2.5 N·m Mc: 4.0 N·m
Overhang load length	Supported on both ends: 125mm or less
	Cantilever: 75 mm or less
Protective structure	IP65 (with air purge)
Ambient operating temperature, humidity	0 to 40°C, 85% RH or less (Non-condensing)

(*) Based on 5,000 km of traveling life

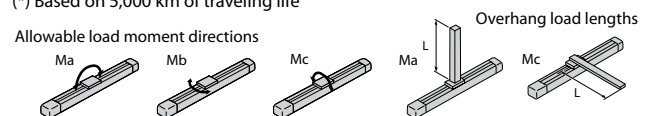

Dimensional Drawings

CAD drawings can be downloaded from the website. www.intelligentactuator.com



* See P11 for the dimensional drawing for the ceiling mount specification. See P12 for the dimensional drawing for the wall mount specification.

- *1 Connect the motor and encoder cables.
- *2 During home return, be careful to avoid interference from peripheral objects because the slider travels until the mechanical end.
- *3 Reference position for calculating moments.

Materials of Main Components

① Base	Extruded aluminum (A6063)	Surface treatment: Alumite coating
② Table	Extruded aluminum (A6063)	Surface treatment: Alumite coating (excluding machined areas)
③ Mounting bracket (front/rear)	Extruded aluminum (A6063)	Surface treatment: Alumite coating (excluding machined areas)
④ Side cover	Extruded aluminum (A6063)	Surface treatment: Alumite coating
⑤ Motor cover	Die-cast aluminum (ADC12)	Surface treatment: Alumite coating + Paint
⑥ Front cover	Die-cast aluminum (ADC12)	Surface treatment: Alumite coating + Paint
⑦ Seal	Urethane rubber (U)	
⑧ Actuator cable	Polyvinyl chloride (PVC)	* High flex type cable
⑨ Air purge joint	Polyphenylene sulfide (PPS)	

* Alumite coating has been removed in the machined areas of the table ② and mounting bracket ③. To add alumite coating to these areas, specify the "Additional alumite coating (code: AL)" option.

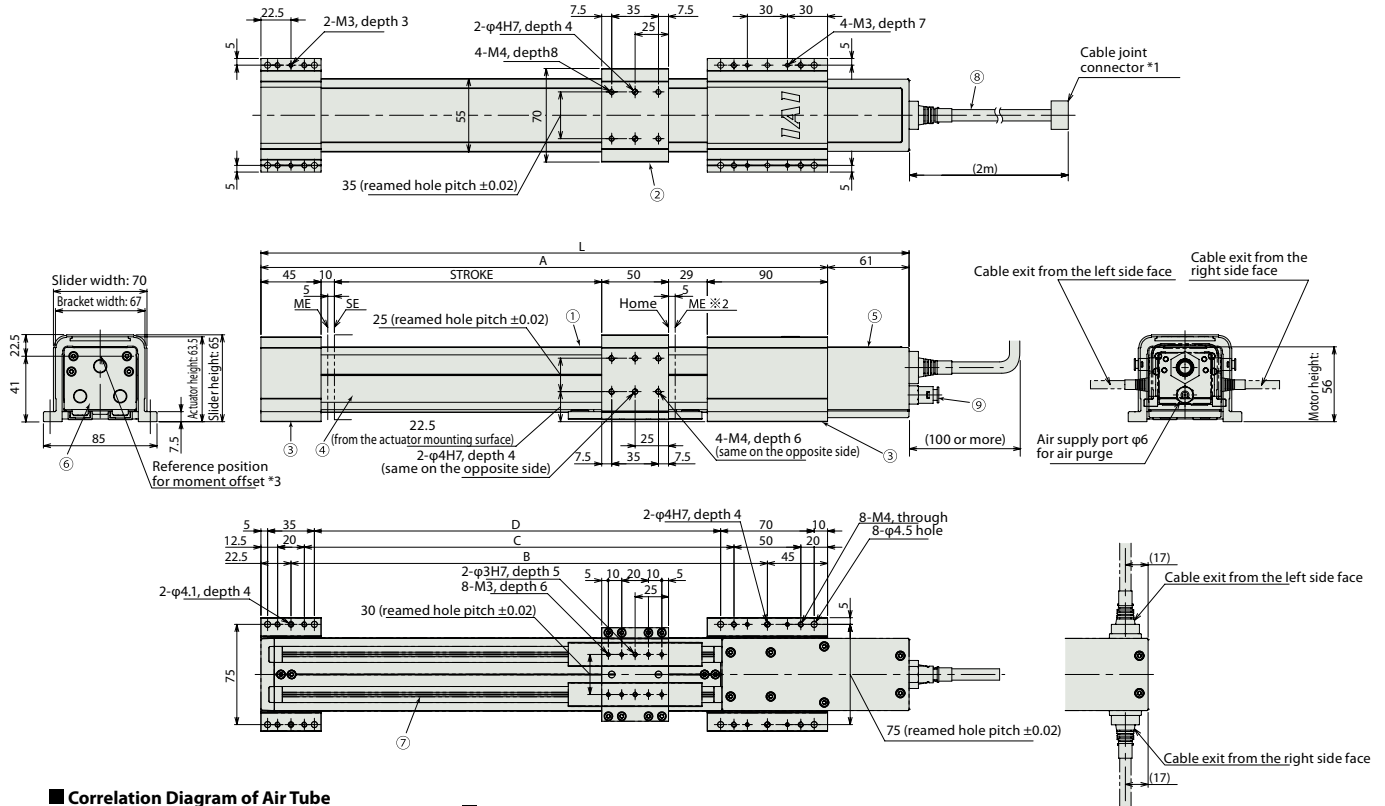

Correlation Diagram of Air Tube Length vs. Air Flow Rate

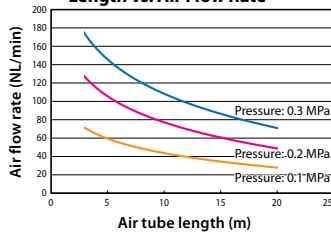

Push Force of RCP4W-SA5

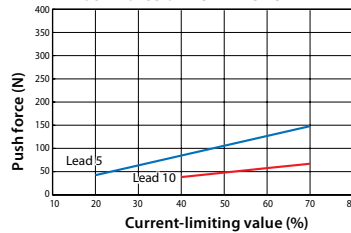

Note on Push-motion Operation

When performing push-motion operation, make sure the reactive moment generated by the push force does not exceed 80% of the dynamic allowable moment (M_a or M_b) specified in the catalog.

In push-motion operation, the travel speed is fixed at 25 mm/s.

Dimensions and Mass by Stroke

Stroke	100	150	200	250	300	350	400	450	500
L	385	435	485	535	585	635	685	735	785
A	324	374	424	474	524	574	624	674	724
B	256.5	306.5	356.5	406.5	456.5	506.5	556.5	606.5	656.5
C	221.5	271.5	321.5	371.5	421.5	471.5	521.5	571.5	621.5
D	204	254	304	354	404	454	504	554	604
Mass (kg)	2.8	2.9	3.1	3.2	3.4	3.5	3.7	3.8	4.0

- The above correlation diagram assumes an air tube of 6 mm in outer diameter and 4 mm in inner diameter. (A joint of 6 mm in outer diameter is used on the actuator side.)
- Use the correlation diagram as a reference to determine an appropriate pressure and air tube length in such a way that the air flow rate will become 40 NL/min or more (clean dry air).

Applicable Controller

RCP4W series actuators can be operated with the controllers indicated below. Select the type according to your intended application.

(Note) These actuators cannot be operated with controllers other than the PCON-CA.

Title	External view	Model number	Features	Maximum number of positioning points	Input power	Power supply capacity	Standard price	Reference page
Positioner type (NPN specification)		PCON-CA-35PI-NP-□-0-□	Register positions to move the actuator into the controller beforehand, and specify the number corresponding to each desired position to operate the actuator.	512 points	DC24V	Rated: 3.5 A Maximum: 4.2 A	-	P13
Positioner type (PNP specification)		PCON-CA-35PI-PN-□-0-□						
Pulse-train type (NPN specification)		PCON-CA-35PI-PLN-□-0-□	The actuator can be operated freely via pulse-train controller from an external output device.					
Pulse-train type (PNP specification)		PCON-CA-35PI-PLP-□-0-□						

RCP4W-SA6C

ROBO Cylinder
Pulse motor

Splash-proof slider type
Coupling specification

Actuator width: 62 mm

Model Specification Items	RCP4W	SA6C	I	42P	<input type="checkbox"/>	<input type="checkbox"/>	P3	<input type="checkbox"/>	<input type="checkbox"/>
	Series	Type	Encoder type	Motor type	Lead	Stroke	Applicable controller	Cable length	Options
			I: Incremental specification * Also select code "I" for the simple absolute specification.	42P: Pulse motor size 42	12: 12mm 6: 6mm	100 : 100mm 600 : 600mm (Can be set in 50-mm increments.)	P3:PCON-CA * The RCP4W can be operated only with the PCON-CA	N: None P: 1 m S: 3 m M: 5 m X <input type="checkbox"/> : Length designation R <input type="checkbox"/> : Robot cable	Refer to the option list below.

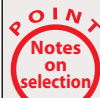

- (1) This actuator is designed exclusively for horizontal installation. It cannot be installed vertically. When hanging the actuator from the ceiling or mounting it on the wall, be sure to do so using an optional dedicated bracket.
- (2) The payload varies depending on the acceleration/deceleration. The upper limit of acceleration/deceleration is 0.6 G.
- (3) The cable joint connector is not splash-proof, so install the connector in a location where it will not come in contact with water.
- (4) Refer to the page at right for the air tube length and air flow rate when implementing air purge.

■ Payload by Acceleration/Deceleration

With the RCP4W series, the payload remains the same even when the speed is raised. However, the payload will drop if the acceleration is raised. Check on the table below.

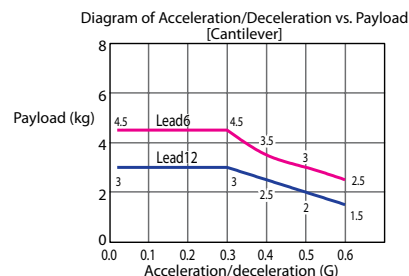
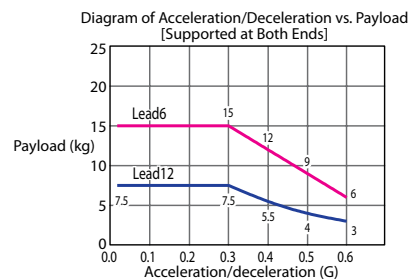

Actuator Specifications

■ Leads and Payloads

Model number	Lead (mm)	Maximum horizontal payload (kg)		Maximum push force (N)	Positioning repeatability (mm)	Stroke (mm)
		Supported on both ends	Cantilever			
RCP4W-SA6C-I-42P-12-①-P3-②-③	12	7.5	3	82.8	±0.02	100 to 600 (in 50-mm increments)
RCP4W-SA6C-I-42P-6-①-P3-②-③	6	15	4.5	179.5		

Legend ① Stroke ② Cable length ③ Options

■ Stroke and Maximum Speed

Lead	Stroke	100 to 600 (in 50-mm increments)
		400
6	200	

(unit: mm/s)

① Stroke

Stroke (mm)	Standard price
100	-
150	-
200	-
250	-
300	-
350	-
400	-
450	-
500	-
550	-
600	-

② Cable length

Type	Cable symbol	Standard price
Standard type	P(1m)	-
	S(3m)	-
	M(5m)	-
Special length	X06(6m) ~ X10(10m)	-
	X11(11m) ~ X15(15m)	-
	X16(16m) ~ X20(20m)	-
	R01(1m) ~ R03(3m)	-
Robot cable	R04(4m) ~ R05(5m)	-
	R06(6m) ~ R10(10m)	-
	R11(11m) ~ R15(15m)	-
	R16(16m) ~ R20(20m)	-

③ Options

Name	Option code	See page	Standard price
Cable exit from the left side face	A1	→P4	-
Cable exit from the right side face	A3	→P4	-
Additional alumite coating	AL	→P4	-
Food grade grease (edible grease)	GE	→P4	-
Non-motor side specification	NM	→P4	-
Ceiling mount (bracket mounted on the left)	HFL	→P4	-
Ceiling mount (bracket mounted on the right)	HFR	→P4	-
Wall mount sideways on the left	TFL	→P4	-
Wall mount sideways on the right	TFR	→P4	-

Actuator Specifications

Item	Description
Drive system	Ball screw φ10 mm, rolled C10
Positioning repeatability	±0.02mm
Lost motion	0.1 mm or less
Static allowable moment	Supported on both ends
	Cantilever
Dynamic allowable moment (*)	Supported on both ends
	Cantilever
Overhang load length	Supported on both ends
	Cantilever
Protective structure	IP65 (with air purge)
Ambient operating temperature, humidity	0 to 40°C, 85% RH or less (Non-condensing)

(*) Based on 5,000 km of traveling life

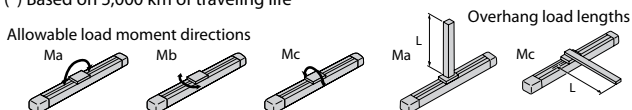

Dimensional Drawings

CAD drawings can be downloaded from the website. www.intelligentactuator.com



* See P11 for the dimensional drawing for the ceiling mount specification. See P12 for the dimensional drawing for the wall mount specification.

*1 Connect the motor and encoder cables.

*2 During home return, be careful to avoid interference from peripheral objects because the slider travels until the mechanical end.

*3 Reference position for calculating moments.

Materials of Main Components

① Base	Extruded aluminum (A6063)	Surface treatment: Alumite coating
② Table	Extruded aluminum (A6063)	Surface treatment: Alumite coating (excluding machined areas)
③ Mounting bracket (front/rear)	Extruded aluminum (A6063)	Surface treatment: Alumite coating (excluding machined areas)
④ Side cover	Extruded aluminum (A6063)	Surface treatment: Alumite coating
⑤ Motor cover	Die-cast aluminum (ADC12)	Surface treatment: Alumite coating + Paint
⑥ Front cover	Die-cast aluminum (ADC12)	Surface treatment: Alumite coating + Paint
⑦ Seal	Urethane rubber (U)	
⑧ Actuator cable	Polyvinyl chloride (PVC)	* High flex type cable
⑨ Air purge joint	Polyphenylene sulfide (PPS)	

* Alumite coating has been removed in the machined areas of the table ② and mounting bracket ③. To add alumite coating to these areas, specify the "Additional alumite coating (code: AL)" option.

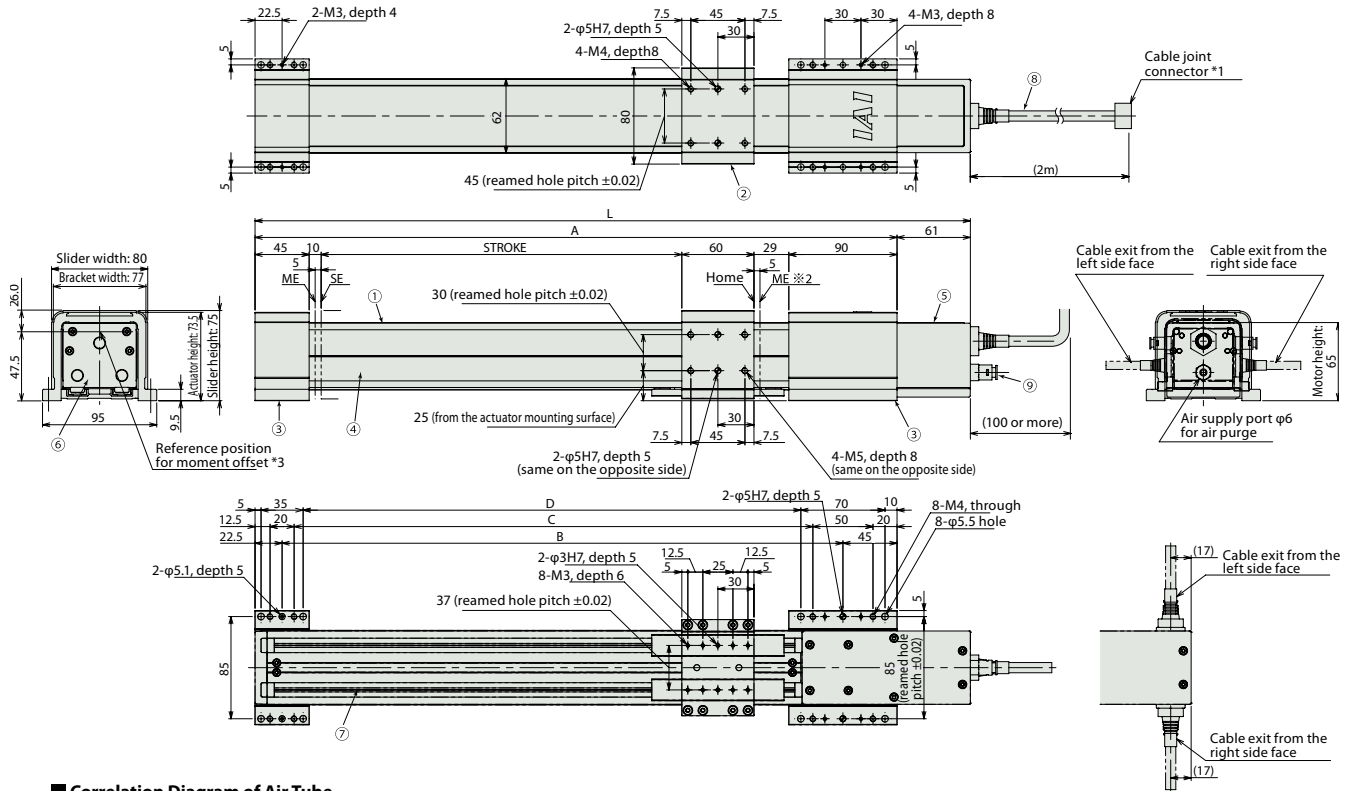

Correlation Diagram of Air Tube Length vs. Air Flow Rate

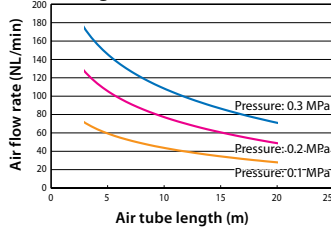

Push Force of RCP4W-SA6

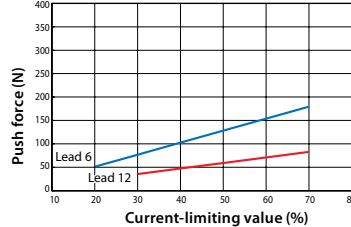

Note on Push-motion Operation

When performing push-motion operation, make sure the reactive moment generated by the push force does not exceed 80% of the dynamic allowable moment (M_a or M_b) specified in the catalog.

In push-motion operation, the travel speed is fixed at 20 mm/s.

Dimensions and Mass by Stroke

Stroke	100	150	200	250	300	350	400	450	500	550	600
L	395	445	495	545	595	645	695	745	795	845	895
A	334	384	434	484	534	584	634	684	734	784	834
B	266.5	316.5	366.5	416.5	466.5	516.5	566.5	616.5	666.5	716.5	766.5
C	231.5	281.5	331.5	381.5	431.5	481.5	531.5	581.5	631.5	681.5	731.5
D	214	264	314	364	414	464	514	564	614	664	714
Mass (kg)	3.9	4.1	4.3	4.5	4.7	4.9	5.1	5.3	5.5	5.8	6.0

- The above correlation diagram assumes an air tube of 6 mm in outer diameter and 4 mm in inner diameter. (A joint of 6 mm in outer diameter is used on the actuator side.)
- Use the correlation diagram as a reference to determine an appropriate pressure and air tube length in such a way that the air flow rate will become 40 NL/min or more (clean dry air).

Applicable Controller

RCP4W series actuators can be operated with the controllers indicated below. Select the type according to your intended application.

(Note) These actuators cannot be operated with controllers other than the PCON-CA.

Title	External view	Model number	Features	Maximum number of positioning points	Input power	Power supply capacity	Standard price	Reference page
Positioner type (NPN specification)		PCON-CA-42PI-NP-□-0-□	Register positions to move the actuator into the controller beforehand, and specify the number corresponding to each desired position to operate the actuator.	512 points	DC24V	Rated: 3.5 A Maximum: 4.2 A	-	P13
Positioner type (PNP specification)		PCON-CA-42PI-PN-□-0-□						
Pulse-train type (NPN specification)		PCON-CA-42PI-PLN-□-0-□	The actuator can be operated freely via pulse-train controller from an external output device.					
Pulse-train type (PNP specification)		PCON-CA-42PI-PLP-□-0-□						

RCP4W-SA7C

ROBO Cylinder
Pulse motor

Splash-proof slider type
Coupling specification

Actuator width: 77 mm

Model Specification Items	RCP4W	SA7C	I	56P	<input type="checkbox"/>	<input type="checkbox"/>	P3	<input type="checkbox"/>	<input type="checkbox"/>
	Series	Type	Encoder type	Motor type	Lead	Stroke	Applicable controller	Cable length	Options
			I: Incremental specification * Also select code "I" for the simple absolute specification.	56P: Pulse motor size 56	16: 16mm 8: 8mm	100 : 100mm 700 : 700mm (Can be set in 50-mm increments.)	P3:PCON-CA * The RCP4W can be operated only with the PCON-CA	N: None P: 1 m S: 3 m M: 5 m X <input type="checkbox"/> : Length designation R <input type="checkbox"/> : Robot cable	Refer to the option list below.

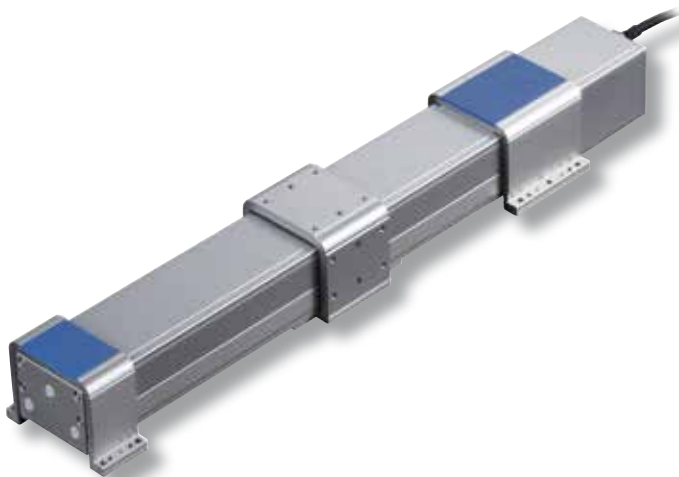

- (1) This actuator is designed exclusively for horizontal installation. It cannot be installed vertically. When hanging the actuator from the ceiling or mounting it on the wall, be sure to do so using an optional dedicated bracket.
- (2) The payload varies depending on the acceleration/deceleration. The upper limit of acceleration/deceleration is 0.6 G.
- (3) The cable joint connector is not splash-proof, so install the connector in a location where it will not come in contact with water.
- (4) Refer to the page at right for the air tube length and air flow rate when implementing air purge.

■ Payload by Acceleration/Deceleration

With the RCP4W series, the payload remains the same even when the speed is raised. However, the payload will drop if the acceleration is raised. Check on the table below.

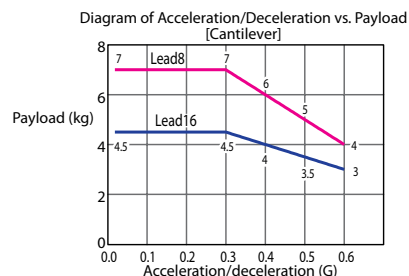
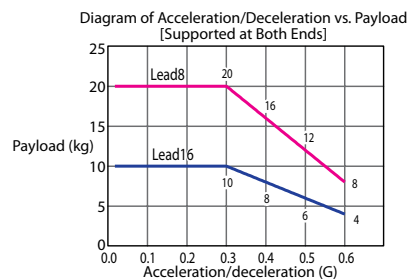

Actuator Specifications

■ Leads and Payloads

Model number	Lead (mm)	Maximum horizontal payload (kg)		Maximum push force (N)	Positioning repeatability (mm)	Stroke (mm)
		Supported on both ends	Cantilever			
RCP4W-SA7C-I-56P-16-①-P3-②-③	16	10	4.5	161.9	±0.02	100 to 700 (in 50-mm increments)
RCP4W-SA7C-I-56P-8-①-P3-②-③	8	20	7	337.9		

Legend ① Stroke ② Cable length ③ Options

■ Stroke and Maximum Speed

Lead	Stroke	100 to 700 (in 50-mm increments)
		16
8		265

(unit: mm/s)

① Stroke

Stroke (mm)	Standard price
100	-
150	-
200	-
250	-
300	-
350	-
400	-
450	-
500	-
550	-
600	-
650	-
700	-

③ Options

Name	Option code	See page	Standard price
Cable exit from the left side face	A1	→P4	-
Cable exit from the right side face	A3	→P4	-
Additional alumite coating	AL	→P4	-
Food grade grease (edible grease)	GE	→P4	-
Non-motor side specification	NM	→P4	-
Ceiling mount (bracket mounted on the left)	HFL	→P4	-
Ceiling mount (bracket mounted on the right)	HFR	→P4	-
Wall mount sideways on the left	TFL	→P4	-
Wall mount sideways on the right	TFR	→P4	-

② Cable length

Type	Cable symbol	Standard price
Standard type	P(1m)	-
	S(3m)	-
	M(5m)	-
Special length	X06(6m) ~ X10 (10m)	-
	X11 (11m) ~ X15 (15m)	-
	X16 (16m) ~ X20 (20m)	-
	R01 (1m) ~ R03 (3m)	-
Robot cable	R04 (4m) ~ R05 (5m)	-
	R06 (6m) ~ R10 (10m)	-
	R11 (11m) ~ R15 (15m)	-
	R16 (16m) ~ R20 (20m)	-

Actuator Specifications

Item	Description
Drive system	Ball screw φ12 mm, rolled C10
Positioning repeatability	±0.02mm
Lost motion	0.1 mm or less
Static allowable moment	Supported on both ends
	Cantilever
Dynamic allowable moment (*)	Supported on both ends
	Cantilever
Overhang load length	Supported on both ends
	Cantilever
Protective structure	IP65 (with air purge)
Ambient operating temperature, humidity	0 to 40°C, 85% RH or less (Non-condensing)

(*) Based on 5,000 km of traveling life

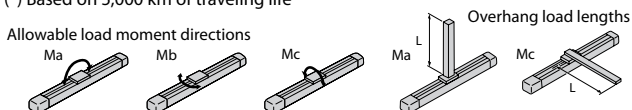

Dimensional Drawings

CAD drawings can be downloaded from the website. www.intelligentactuator.com



* See P11 for the dimensional drawing for the ceiling mount specification. See P12 for the dimensional drawing for the wall mount specification.

*1 Connect the motor and encoder cables.

*2 During home return, be careful to avoid interference from peripheral objects because the slider travels until the mechanical end.

*3 Reference position for calculating moments.

Materials of Main Components

① Base	Extruded aluminum (A6063)	Surface treatment: Alumite coating
② Table	Extruded aluminum (A6063)	Surface treatment: Alumite coating (excluding machined areas)
③ Mounting bracket (front/rear)	Extruded aluminum (A6063)	Surface treatment: Alumite coating (excluding machined areas)
④ Side cover	Extruded aluminum (A6063)	Surface treatment: Alumite coating
⑤ Motor cover	Die-cast aluminum (ADC12)	Surface treatment: Alumite coating + Paint
⑥ Front cover	Die-cast aluminum (ADC12)	Surface treatment: Alumite coating + Paint
⑦ Seal	Urethane rubber (U)	
⑧ Actuator cable	Polyvinyl chloride (PVC)	* High flex type cable
⑨ Air purge joint	Polyphenylene sulfide (PPS)	

* Alumite coating has been removed in the machined areas of the table ② and mounting bracket ③. To add alumite coating to these areas, specify the "Additional alumite coating (code: AL)" option.

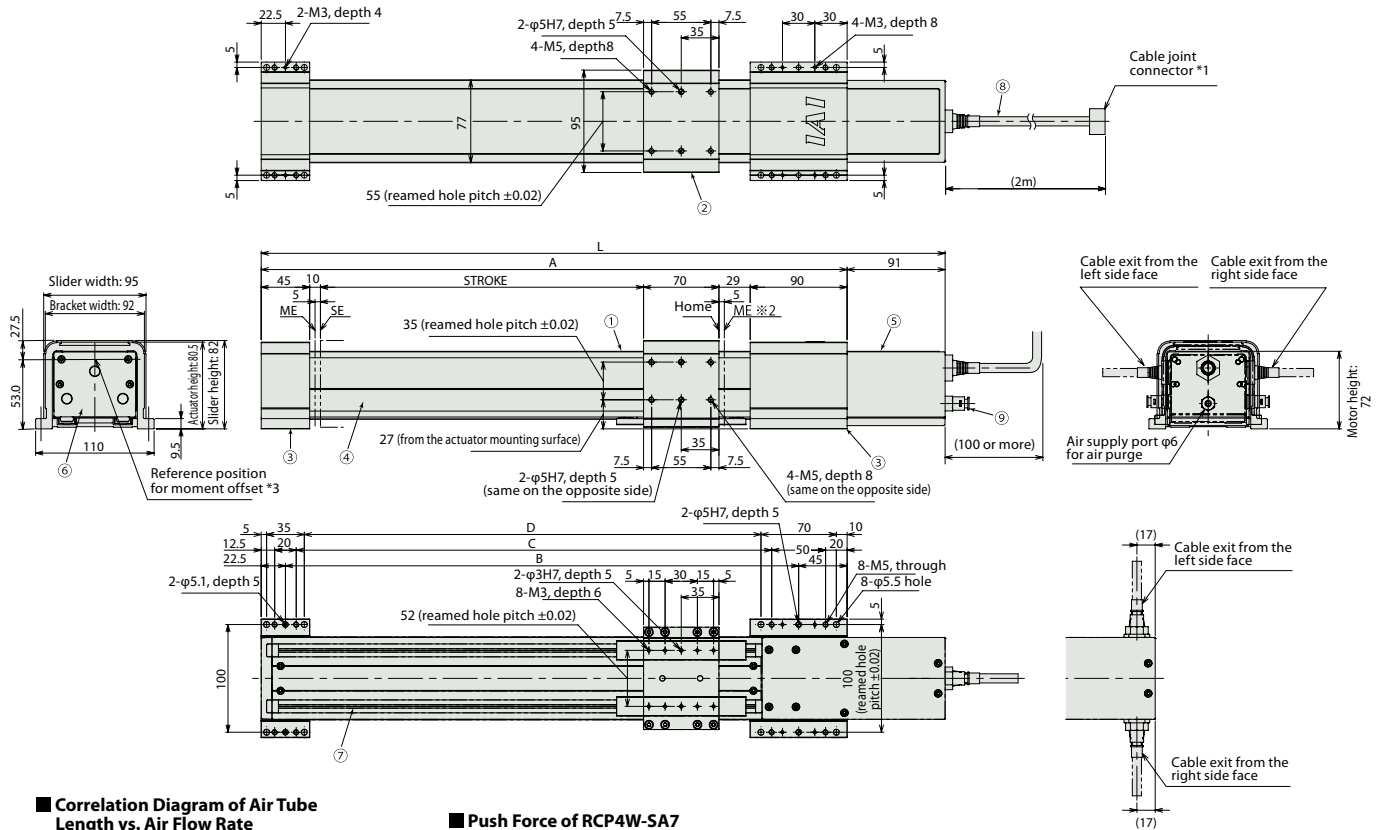

Correlation Diagram of Air Tube Length vs. Air Flow Rate

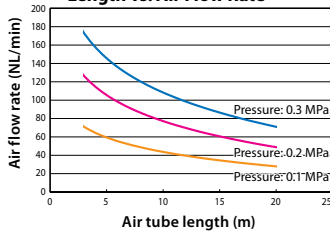

- The above correlation diagram assumes an air tube of 6 mm in outer diameter and 4 mm in inner diameter. (A joint of 6 mm in outer diameter is used on the actuator side.)
- Use the correlation diagram as a reference to determine an appropriate pressure and air tube length in such a way that the air flow rate will become 40 NL/min or more (clean dry air).

Push Force of RCP4W-SA7

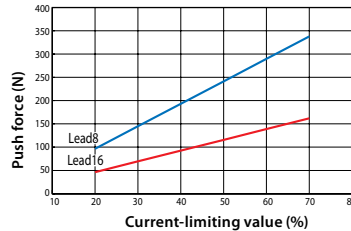

Note on Push-motion Operation

When performing push-motion operation, make sure the reactive moment generated by the push force does not exceed 80% of the dynamic allowable moment (M_a or M_b) specified in the catalog.

In push-motion operation, the travel speed is fixed at 20 mm/s.

Dimensions and Mass by Stroke

Stroke	100	150	200	250	300	350	400	450	500	550	600	650	700
L	435	485	535	585	635	685	735	785	835	885	935	985	1035
A	344	394	444	494	544	594	644	694	744	794	844	894	944
B	276.5	326.5	376.5	426.5	476.5	526.5	576.5	626.5	676.5	726.5	776.5	826.5	876.5
C	241.5	291.5	341.5	391.5	441.5	491.5	541.5	591.5	641.5	691.5	741.5	791.5	841.5
D	224	274	324	374	424	474	524	574	624	674	724	774	824
Mass (kg)	5.9	6.2	6.5	6.8	7.1	7.4	7.6	7.9	8.2	8.5	8.8	9.0	9.3

Applicable Controller

RCP4W series actuators can be operated with the controllers indicated below. Select the type according to your intended application.

(Note) These actuators cannot be operated with controllers other than the PCON-CA.

Title	External view	Model number	Features	Maximum number of positioning points	Input power	Power supply capacity	Standard price	Reference page
Positioner type (NPN specification)		PCON-CA-56PI-NP-□-0-□	Register positions to move the actuator into the controller beforehand, and specify the number corresponding to each desired position to operate the actuator.	512 points	DC24V	Rated: 3.5 A Maximum: 4.2 A	-	P13
Positioner type (PNP specification)		PCON-CA-56PI-PN-□-0-□						
Pulse-train type (NPN specification)		PCON-CA-56PI-PLN-□-0-□	The actuator can be operated freely via pulse-train controller from an external output device.					
Pulse-train type (PNP specification)		PCON-CA-56PI-PLP-□-0-□						

Dimensions of the Ceiling Mount Specification

The dimensions shown assume that the ceiling mount option (code: HFR/HFL) is selected.

RCP4W-SA5C

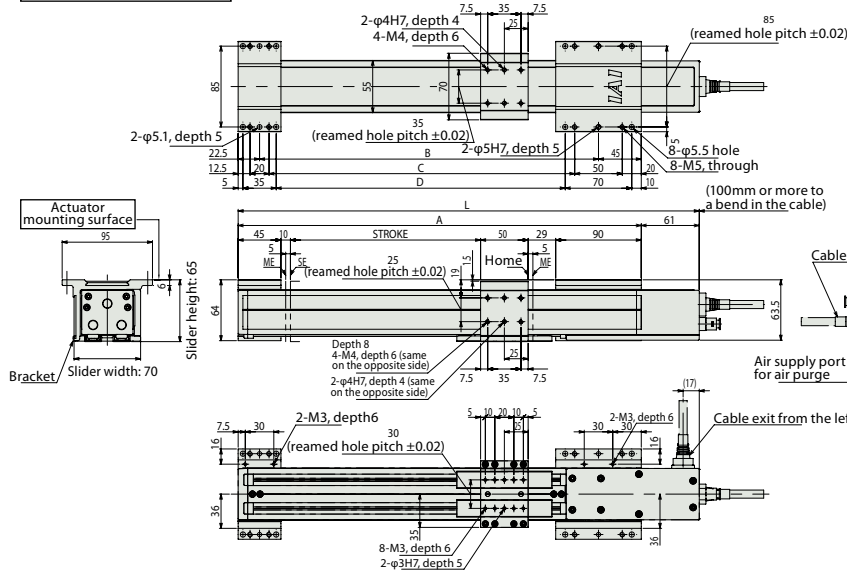

* The bracket is mounted on the right (code: HFR) in this drawing. When the bracket is mounted on the left (code: HFL), the positions of the mounting holes remain the same and the bracket on the side simply moves to the left.

■ Dimensions and Mass by Stroke

Stroke	100	150	200	250	300	350	400	450	500
L	385	435	485	535	585	635	685	735	785
A	324	374	424	474	524	574	624	674	724
B	256.5	306.5	356.5	406.5	456.5	506.5	556.5	606.5	656.5
C	221.5	271.5	321.5	371.5	421.5	471.5	521.5	571.5	621.5
D	204	254	304	354	404	454	504	554	604
Mass (kg)	2.8	2.9	3.1	3.2	3.4	3.5	3.7	3.8	4.0

RCP4W-SA6C

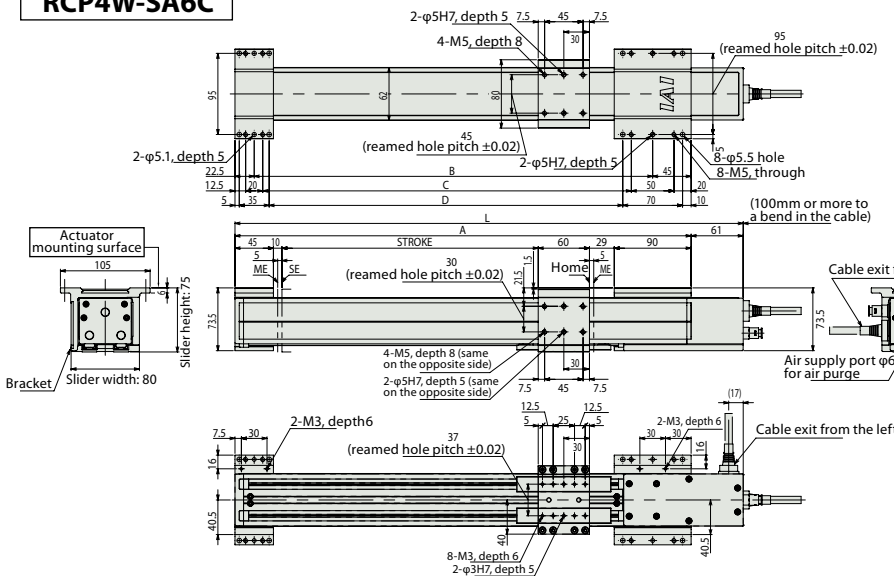

* The bracket is mounted on the right (code: HFR) in this drawing. When the bracket is mounted on the left (code: HFL), the positions of the mounting holes remain the same and the bracket on the side simply moves to the left.

■ Dimensions and Mass by Stroke

Stroke	100	150	200	250	300	350
L	395	445	495	545	595	645
A	334	384	434	484	534	584
B	266.5	316.5	366.5	416.5	466.5	516.5
C	231.5	281.5	331.5	381.5	431.5	481.5
D	214	264	314	364	414	464
Mass (kg)	3.9	4.1	4.3	4.5	4.7	4.9

Stroke	400	450	500	550	600
L	695	745	795	845	895
A	634	684	734	784	834
B	566.5	616.5	666.5	716.5	766.5
C	531.5	581.5	631.5	681.5	731.5
D	514	564	614	664	714
Mass (kg)	5.1	5.3	5.5	5.8	6.0

RCP4W-SA7C

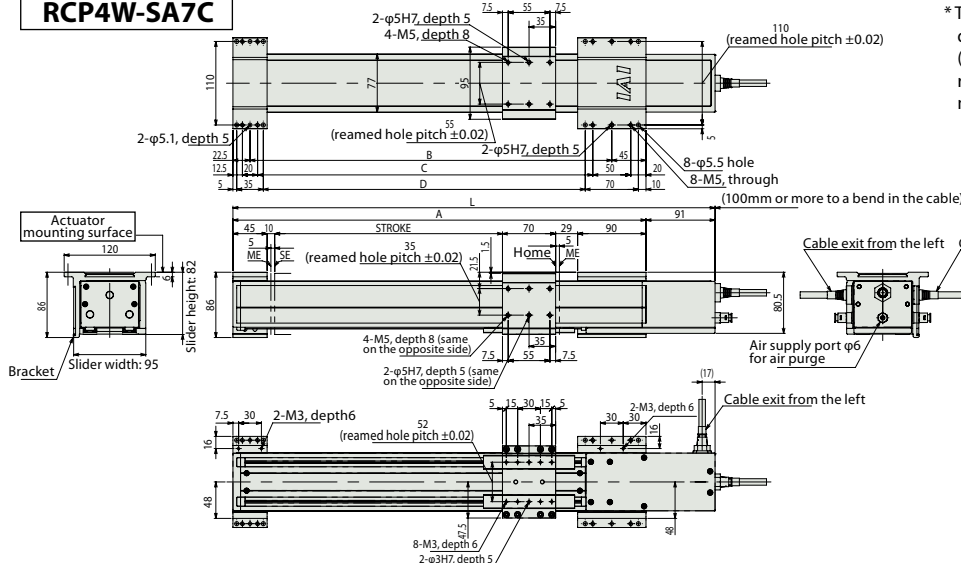

* The bracket is mounted on the right (code: HFR) in this drawing. When the bracket is mounted on the left (code: HFL), the positions of the mounting holes remain the same and the bracket on the side simply moves to the left.

■ Dimensions and Mass by Stroke

Stroke	100	150	200	250	300	350	400
L	435	485	535	585	635	685	735
A	344	394	444	494	544	594	644
B	276.5	326.5	376.5	426.5	476.5	526.5	576.5
C	241.5	291.5	341.5	391.5	441.5	491.5	541.5
D	224	274	324	374	424	474	524
Mass (kg)	5.9	6.2	6.5	6.8	7.1	7.4	7.6

Stroke	450	500	550	600	650	700
L	785	835	885	935	985	1035
A	694	744	794	844	894	944
B	626.5	676.5	726.5	776.5	826.5	876.5
C	591.5	641.5	691.5	741.5	791.5	841.5
D	574	624	674	724	774	824
Mass (kg)	7.9	8.2	8.5	8.8	9.0	9.3

Dimensions of the Wall Mount Specification

The dimensions shown assume that the wall mount option (code: TFR/TFL) is selected.

RCP4W-SA5C

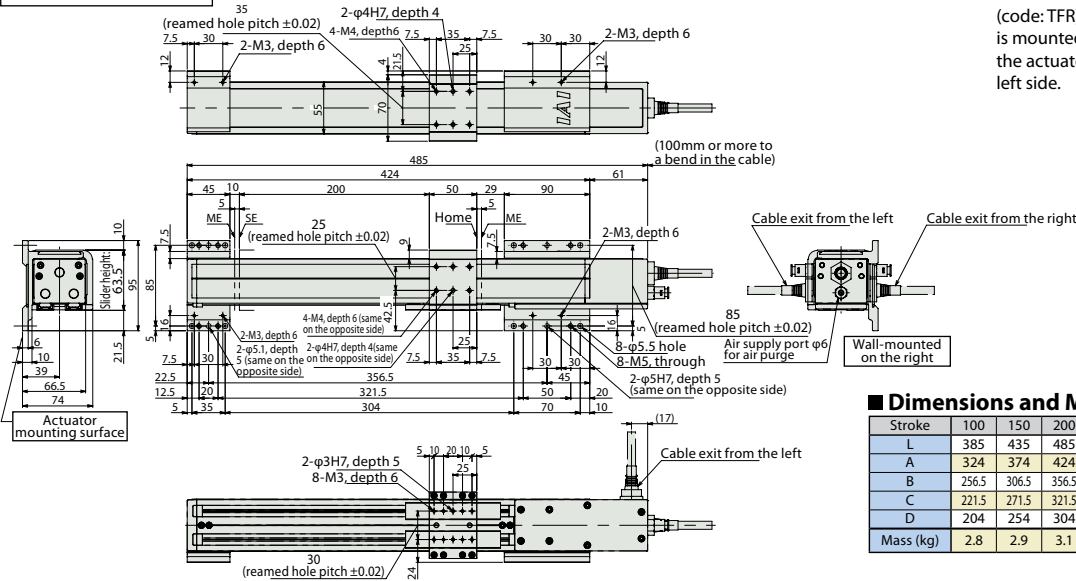

*The actuator is mounted sideways on the right (code: TFR) in this drawing. When the actuator is mounted sideways on the left (code: TFL), the actuator mounting surface comes to the left side.

■ Dimensions and Mass by Stroke

Stroke	100	150	200	250	300	350	400	450	500
L	385	435	485	535	585	635	685	735	785
A	324	374	424	474	524	574	624	674	724
B	256.5	306.5	356.5	406.5	456.5	506.5	556.5	606.5	656.5
C	221.5	271.5	321.5	371.5	421.5	471.5	521.5	571.5	621.5
D	204	254	304	354	404	454	504	554	604
Mass (kg)	2.8	2.9	3.1	3.2	3.4	3.5	3.7	3.8	4.0

RCP4W-SA6C

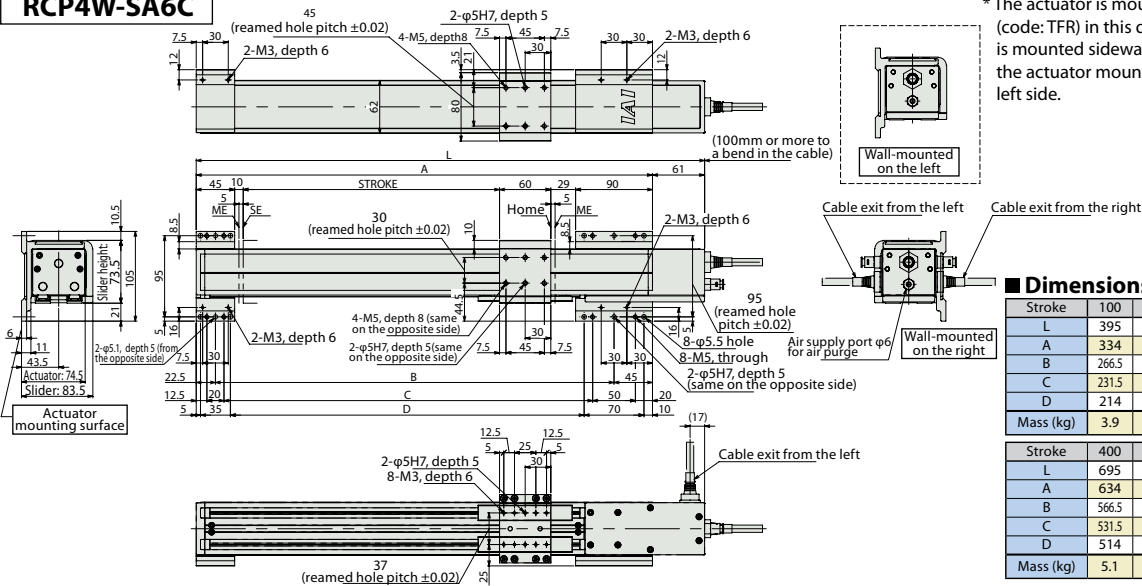

*The actuator is mounted sideways on the right (code: TFR) in this drawing. When the actuator is mounted sideways on the left (code: TFL), the actuator mounting surface comes to the left side.

■ Dimensions and Mass by Stroke

Stroke	100	150	200	250	300	350
L	395	445	495	545	595	645
A	334	384	434	484	534	584
B	266.5	316.5	366.5	416.5	466.5	516.5
C	231.5	281.5	331.5	381.5	431.5	481.5
D	214	264	314	364	414	464
Mass (kg)	3.9	4.1	4.3	4.5	4.7	4.9

Stroke	400	450	500	550	600
L	695	745	795	845	895
A	634	684	734	784	834
B	566.5	616.5	666.5	716.5	766.5
C	531.5	581.5	631.5	681.5	731.5
D	514	564	614	664	714
Mass (kg)	5.1	5.3	5.5	5.8	6.0

RCP4W-SA7C

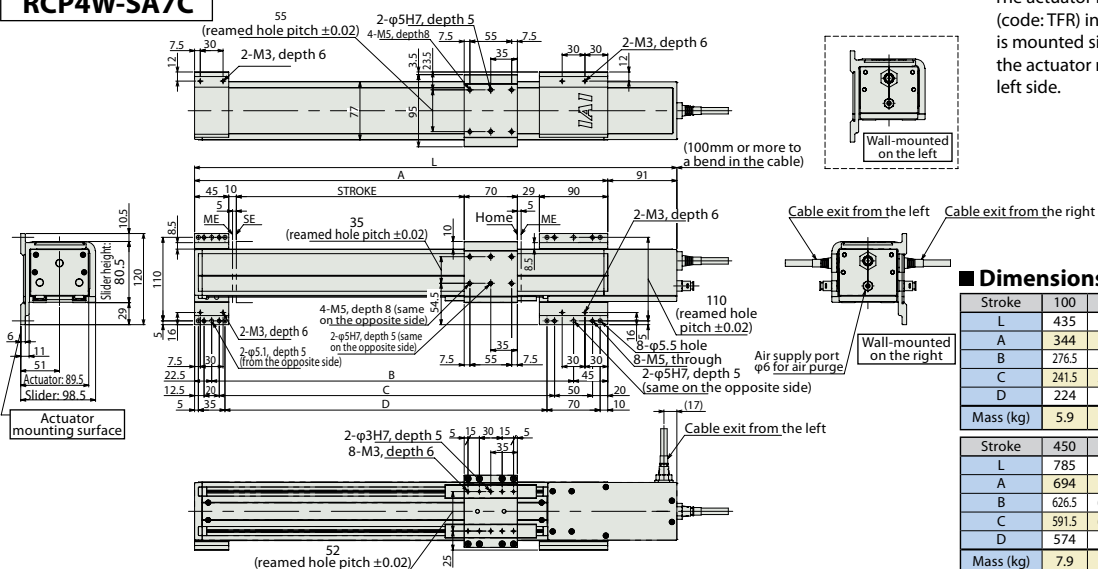

*The actuator is mounted sideways on the right (code: TFR) in this drawing. When the actuator is mounted sideways on the left (code: TFL), the actuator mounting surface comes to the left side.

■ Dimensions and Mass by Stroke

Stroke	100	150	200	250	300	350	400
L	435	485	535	585	635	685	735
A	344	394	444	494	544	594	644
B	276.5	326.5	376.5	426.5	476.5	526.5	576.5
C	241.5	291.5	341.5	391.5	441.5	491.5	541.5
D	224	274	324	374	424	474	524
Mass (kg)	5.9	6.2	6.5	6.8	7.1	7.4	7.6

Stroke	450	500	550	600	650	700
L	785	835	885	935	985	1035
A	694	744	794	844	894	944
B	626.5	676.5	726.5	776.5	826.5	876.5
C	591.5	641.5	691.5	741.5	791.5	841.5
D	574	624	674	724	774	824
Mass (kg)	7.9	8.2	8.5	8.8	9.0	9.3

PCON-CA



**Positioner / Pulse-train Type
Controller with High-output Driver for RCP4W
<Power CON 150>**

Refer to the RCP4 catalog for details on this controller. *The RCP4W can be operated only with the PCON-CA.

List of Models

ROBO Cylinder Position Controller PowerCON 150 <PCON-CA>

External view				Field network type						
I/O type		Positioner type	Pulse-train type							
				DeviceNet connection specification	CC-Link connection specification	PROFIBUS-DP connection specification	CompoNet connection specification	MECHATROLINK connection specification	EtherCAT connection specification	EtherNet/IP connection specification
I/O type model number		NP/PN	PLN/PLP	DV	CC	PR	CN	ML	EC	EP
Standard price	Incremental specification		-	-	-	-	-	-	-	-
	Simple absolute specification	with absolute battery	-	-	-	-	-	-	-	-
		with absolute battery unit	-	-	-	-	-	-	-	-
		No absolute battery	-	-	-	-	-	-	-	-

Model Number

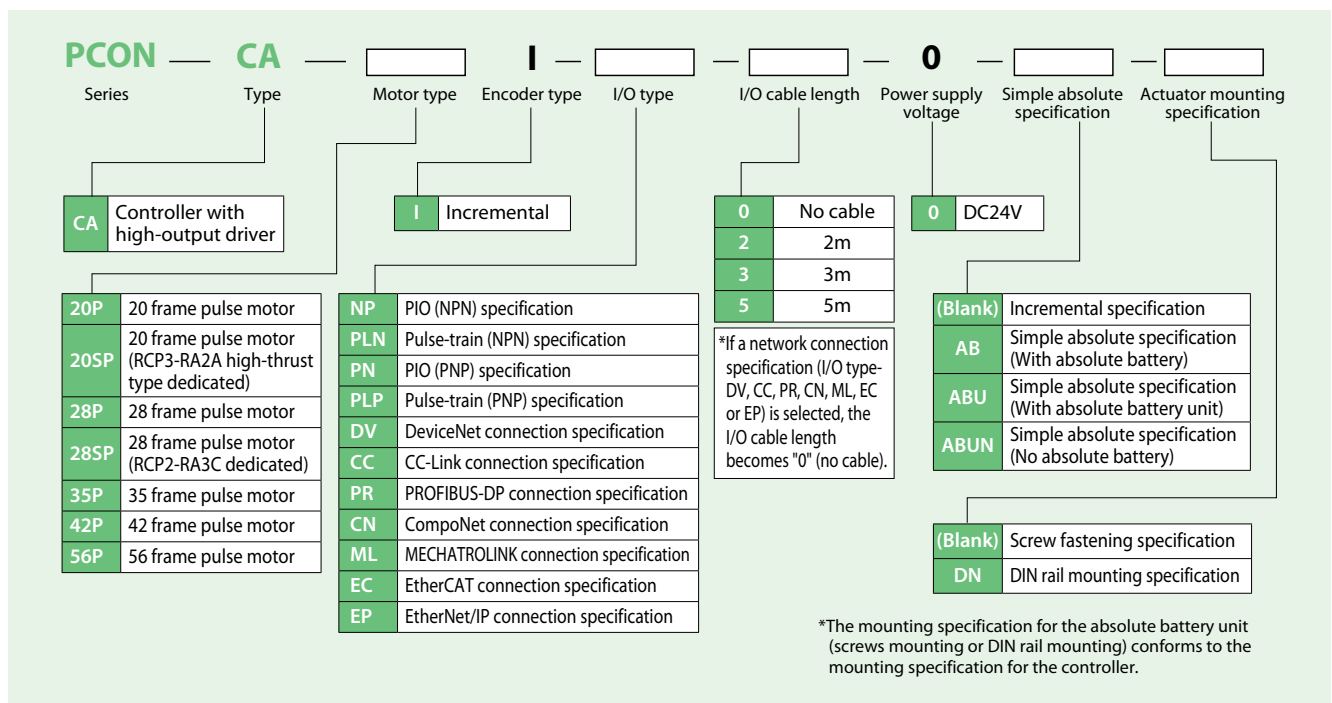

External Dimensions

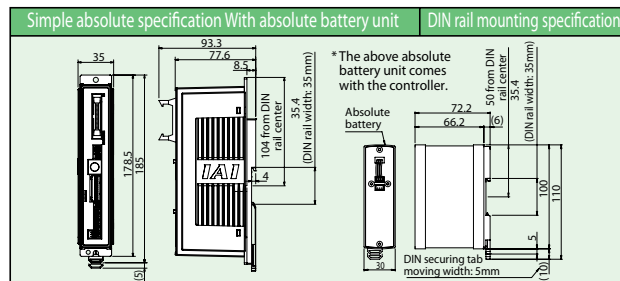
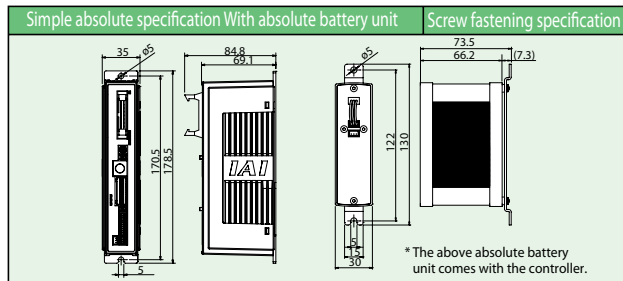
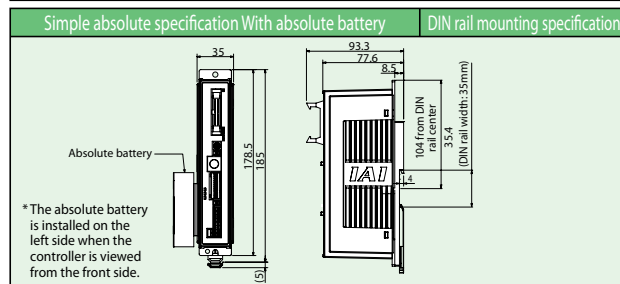
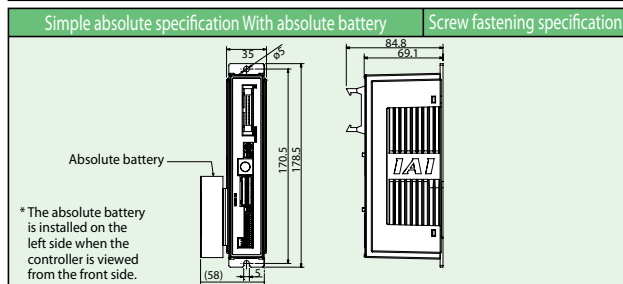
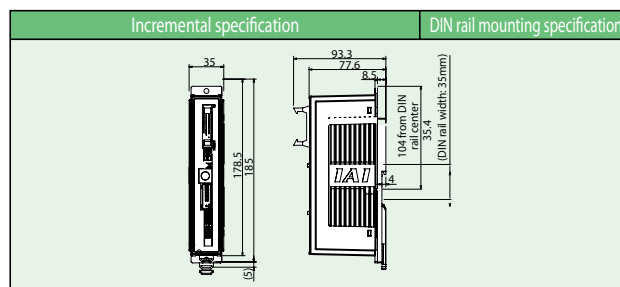
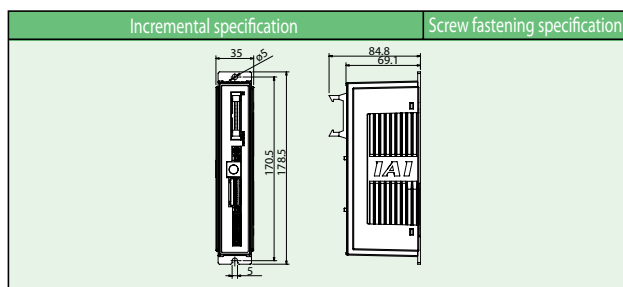

Specification Table

Item		Description
Number of controlled axes		1 axis
Power supply voltage		24VDC \pm 10%
Load capacity	RCP4W Motor type	35P, 42P, 56P
Heat output		Rated 3.5 A / maximum 4.2 A (Note 1)
Rush current (Note 2)		8W
Actuator cable length		8.3A
External interface		20m max.
Data setting/input method		PIO specification
Data retention memory		Dedicated 24-VDC signal input/output (NPN or PNP selected) --- Up to 16 input points, up to 16 output points / Cable length: 10 m max.
Number of positions in positioner mode		PC software, touch-panel teaching pendant, teaching pendant
Pulse-train interface	Input pulse	Position data and parameters are saved in the non-volatile memory (rewrite life: unlimited)
	Command pulse magnification (electronic gear ratio: A/B)	Standard 64 points, maximum 512 points (PIO specification) Note) Positioning points vary depending on the selected PIO pattern.
	Feedback pulse output	Differential method (line driver method): 200 kpps max. / Cable length: 10 m max. Open collector method: Not supported (Note 3)
LED display (installed on the front panel)		$1/50 < A/B < 50/1$ Setting range of A and B (set by parameters): 1 to 4096
Isolation resistance		SV (green)/ALM (red): Servo ON/alarm generation STS0 to 3: Status indication RDY (green)/ALM (red): Absolute function normal/absolute function abnormal (simple absolute specification) 1,0 (green) (red): Absolute function status indication (simple absolute specification)
Mass (Note 4)	Incremental specification	500 VDC, 10 M Ω or more
	Simple absolute specification (190g of battery weight included)	Screw fastening type: 250g or less DIN rail securing type: 285g or less
Environment	Ambient operating temperature	Screw fastening type: 450g or less DIN rail securing type: 485g or less
	Ambient operating humidity	0 to 40°C
	Operating ambience	85%RH or less (non-condensing) Not exposed to corrosive gases

(Note 1) The value increases by 0.3 A for the field network specification.

(Note 2) After the power is turned on, rush current will flow for approx. 5msec (at 40°C). Take note that the rush current varies depending on the impedance of the power-supply line.

(Note 3) If the host implements open collector output, use the separately sold AK-04 (optional) to convert the signals to differential output signals.

(Note 4) The value increases by 30g for the field network specification.

IAI America, Inc.

Headquarters: 2690 W. 237th Street Torrance, CA 90505 (800) 736-1712

Chicago Office: 1261 Hamilton Parkway Itasca, IL 60143 (800) 944-0333

Atlanta Office: 1220 Kennestone Circle, Suite 108, Marietta, GA 30066 (888) 354-9470

IAI Industrieroboter GmbH

Ober der Roth 4, D-65824 Schwalbach am Taunus, Germany

www.intelligentactuator.com

The information contained in this product brochure may change without prior notice due to product improvements.

