

AC Servo Motor **ROBO Cylinder**®

With Battery-less Absolute Encoder

RCA	RCACR
RCS2	RCS2CR
RCS3	RCS3CR
ACON-CB	DCON-CB
SCON-CB	

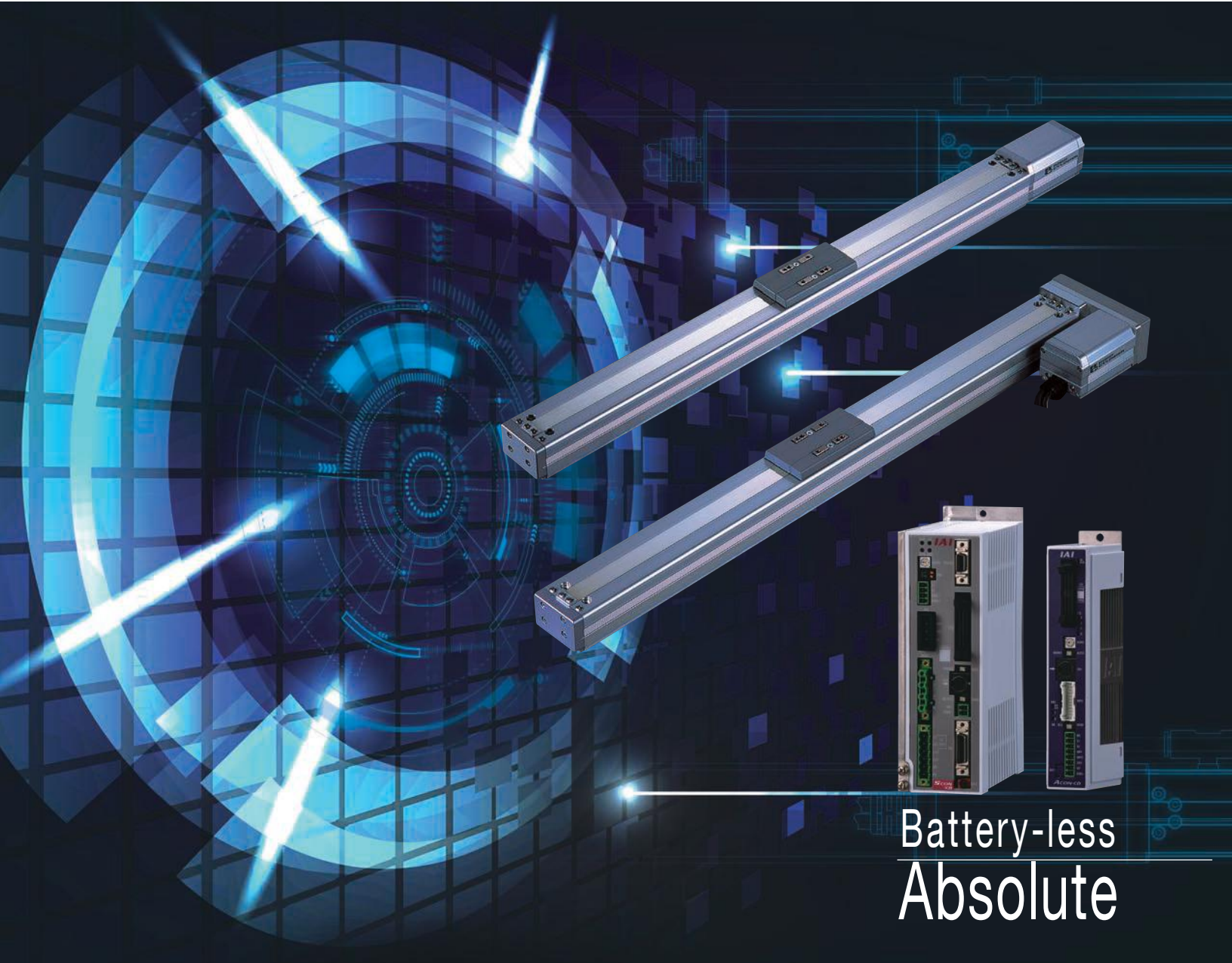

Battery-less
Absolute

Actuator with Battery-less
Absolute Encoder
& CB-type Controller

BENEFITS

BENEFIT

1

Battery-less Absolute Type Added to 24V and 200V Servo Actuators

Applicable models

RCA
RCS2
RCS3

Advantage with Absolute Encoder

1 Home-return Operation Not Necessary at Startup

Decreases startup time.

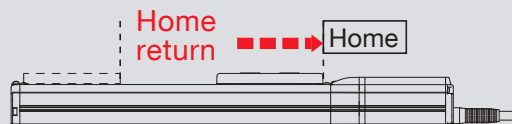

e.g.) Home-return operation from 300mm of stroke takes approximately 16 seconds.

2 Home Position Check Sensor Not Necessary

Simplifies the wiring layout. It also eliminates malfunctions caused by sensor-related issues.

3 Position Information Retained While Power Cut Off

Even after the machine is stopped due to power loss, it resumes operation from the same position.

Advantage with Battery-less

1 Unnecessary to Purchase Batteries

Decreases initial cost and maintenance cost.

2 Unnecessary to Replace or Charge Battery Regularly

Decreases time required for maintenance.

3 Unnecessary to Secure Installation Space for Battery

Saves space inside the control panel.

4 No Alarm for Battery Voltage Drop

Decreases downtime of the equipment.

Battery-less Absolute Saves Cost!!

Assuming using RCA-SA4C 100mm Stroke Length for ten years;

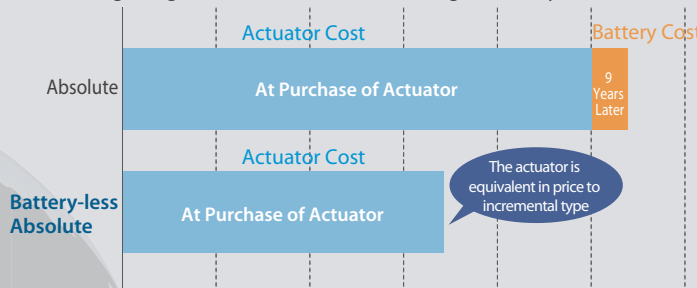

Absolute type requires battery replacement every three years.

Eco-friendly Battery-less Absolute Type Uses No Battery

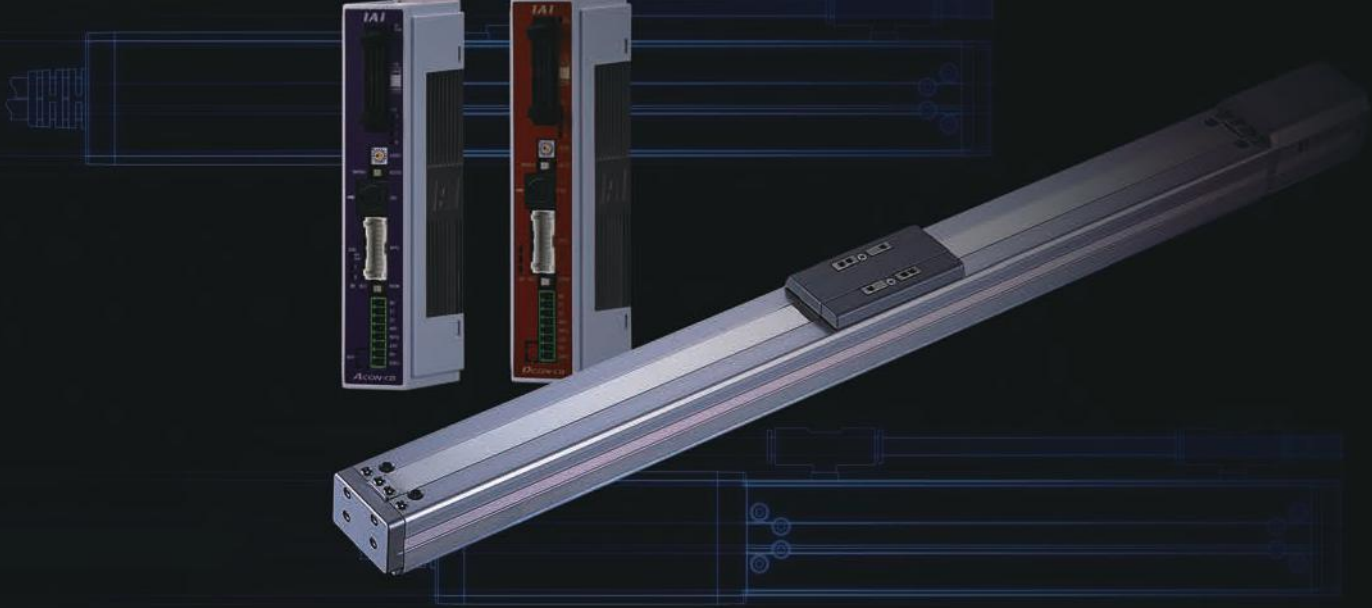

BENEFIT

2

Equipped with a Feature to Detect Motor Overload and Generate Alarm

Applicable models

**ACON-CB
DCON-CB
SCON-CB**

It is possible to monitor motor temperature changes that happen due to grease drying up or components wearing out. An alarm will be generated when the temperature exceeds the value set in advance. This enables to detect a change before malfunction or trouble occurs.

Warning output enables to detect such things as described below.

- Time to supply grease
- Time to replace component
- Time to implement mechanical tuning

Load Increase

Example for motor temperature change in error condition

Alarm Output

Alarm Occurred
ROBO Cylinder stops.
Reset is required in order to recover from alarm.

Warning Output

Overload Warning Occurred
ROBO Cylinder continues to operate.

Conduct Maintenance

Overload Alarm Detection Line (100%)

Overload "Warning" Line

* Set in ratio to parameter load level
Setting can be established with any number from 50 to 99% with the error detection level as 100%.

Any malfunction or trouble can be prevented by conducting maintenance after the warning output.

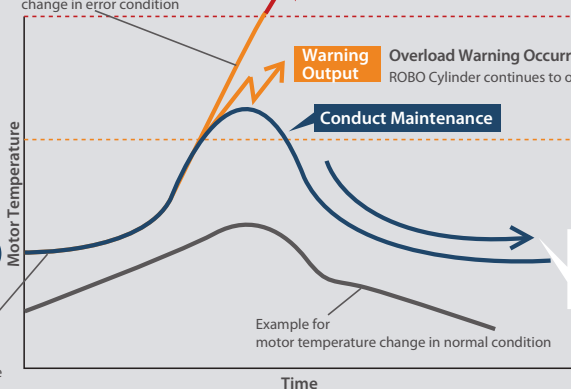

BENEFIT

3

Fully Equipped with Monitoring Feature

Applicable models

**ACON-CB
DCON-CB
SCON-CB**

- ☑ Like a trigger function of an oscilloscope, waveforms of position and velocity can be acquired from the moment that the condition of a selected signal is changed.
- ☑ Signal status of positioning complete, alarms and so on can also be acquired.

Monitoring Feature Window (Example)

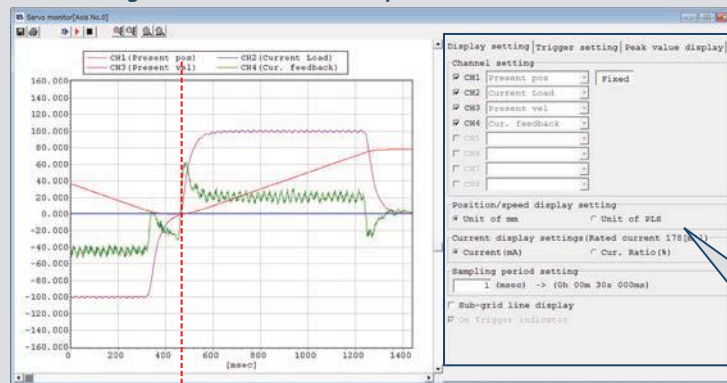

Turn on CSTR (Start) signal

Display Setting

Channel setting: CH1 Present pos (Fixed), CH2 Current Load, CH3 Present vel, CH4 Cur. feedback. Position/speed display setting: Unit of mm, Unit of PLS. Current display settings (Rated current 170A): Current (mA), Cur. Ratio(%). Sampling period setting: 1 (msec) -> (0h 0m 30s 00ms). Sub-grid line display: On (Trigger indicator).

* Items to be monitored can be selected.

Trigger Setting



Trigger setting: CH1 (Present pos) assign (Start), CH2 (Current Load) assign (Start), CH3 (Present vel) assign (Start), CH4 (Cur. feedback) assign (Start). Trigger type: Rising edge (Start), Falling edge (Start), Both (Start). Trigger delay time: 0.000 (msec). Trigger delay time: 0.000 (msec). Trigger delay time: 0.000 (msec). Trigger delay time: 0.000 (msec).

* Data acquiring starts from time of change of selected items.



LINE UP

We prepared 29 types of battery-less absolute type actuators in 6 series in total. We also prepared cleanroom types so you can use them in many applications.

Motor Type 24V Servo Motor

Environment of Use	Name	External View	Maximum Speed	Maximum Payload	Cleanliness	Reference Page
Standard 	RCA-SA4C		665mm/sec	8kg (horizontal) 4.5kg (vertical)	—	P. 5
	RCA-SA4R	40mm				P. 11
	RCA-SA5C		SA5C 1300mm/sec (horizontal) 800mm/sec (vertical)	12kg (horizontal) 4kg (vertical)	—	P. 7
	RCA-SA5R	52mm				SA5R 800mm/sec
	RCA-SA6C		SA6C 1300mm/sec (horizontal) 800mm/sec (vertical)	18kg (horizontal) 6kg (vertical)	—	P. 9
	RCA-SA6R	58mm				SA6R 800mm/sec
Cleanroom 	RCACR-SA4C		665mm/sec	8kg (horizontal) 4.5kg (vertical)	Class 10 (Fed.Std.209D) Equivalent to Class 2.5 (ISO 14644-1)	P. 45
	RCACR-SA5C		1300mm/sec (horizontal) 800mm/sec (vertical)	12kg (horizontal) 4kg (vertical)	Class 10 (Fed.Std.209D) Equivalent to Class 2.5 (ISO 14644-1)	P. 47
	RCACR-SA6C		1300mm/sec (horizontal) 800mm/sec (vertical)	18kg (horizontal) 6kg (vertical)	Class 10 (Fed.Std.209D) Equivalent to Class 2.5 (ISO 14644-1)	P. 49

Motor Type 200V Servo Motor

Environment of Use	Name	External View	Maximum Speed	Maximum Payload	Cleanliness	Reference Page
Standard 	RCS2-SA4C		SA4C 1060mm/sec	8kg (horizontal) 4.5kg (vertical)	—	P. 17
	RCS2-SA4R		40mm			SA4R 665mm/sec
	RCS2-SA5C		SA5C 1300mm/sec (horizontal) 800mm/sec (vertical)	12kg (horizontal) 4kg (vertical)	—	P. 19
	RCS2-SA5R		52mm			SA5R 800mm/sec

Environment of Use	Name	External View	Maximum Speed	Maximum Payload	Cleanliness	Reference Page	
<div style="background-color: #333; color: white; padding: 5px; text-align: center; width: fit-content; margin: 0 auto;">Standard</div> 	RCS2-SA6C		SA6C 1300mm/sec (horizontal) 800mm/sec (vertical)	18kg (horizontal) 6kg (vertical)	—	P. 21	
	RCS2-SA6R	58mm	SA6R 800mm/sec			P. 29	
	RCS2-SA7C		SA7C 1200mm/sec (horizontal)	40kg (horizontal) 12kg (vertical)	—	P. 23	
	RCS2-SA7R	73mm	SA7R 800mm/sec			P. 31	
	RCS3-SA8C		1800mm/sec	80kg (horizontal) 16kg (vertical)	—	P. 37	
	RCS3-SA8R	80mm				P. 41	
	RCS3-SS8C		1800mm/sec	80kg (horizontal) 16kg (vertical)	—	P. 39	
	RCS3-SS8R	80mm				P. 43	
	RCS2-RA5C		800mm/sec	RA5C 60kg (horizontal) 18kg (vertical)	—	P. 33	
	RCS2-RA5R	55mm		RA5R 50kg (horizontal) 11.5kg (vertical)		P. 35	
	<div style="background-color: #4CAF50; color: white; padding: 5px; text-align: center; width: fit-content; margin: 0 auto;">Cleanroom</div> 	RCS2CR-SA4C		665mm/sec	8kg (horizontal) 4.5kg (vertical)	Class 10 (Fed.Std.209D) Equivalent to Class 2.5 (ISO 14644-1)	P. 51
		RCS2CR-SA5C		1300mm/sec (horizontal) 800mm/sec (vertical)	12kg (horizontal) 4kg (vertical)	Class 10 (Fed.Std.209D) Equivalent to Class 2.5 (ISO 14644-1)	P. 53
RCS2CR-SA6C			1300mm/sec (horizontal) 800mm/sec (vertical)	18kg (horizontal) 6kg (vertical)	Class 10 (Fed.Std.209D) Equivalent to Class 2.5 (ISO 14644-1)	P. 55	
RCS2CR-SA7C			800mm/sec	40kg (horizontal) 12kg (vertical)	Class 10 (Fed.Std.209D) Equivalent to Class 2.5 (ISO 14644-1)	P. 57	
RCS3CR-SA8C			1800mm/sec	80kg (horizontal) 16kg (vertical)	Class 10 (Fed.Std.209D) Equivalent to Class 2.5 (ISO 14644-1)	P. 59	
RCS3CR-SS8C			1800mm/sec	80kg (horizontal) 16kg (vertical)	Class 10 (Fed.Std.209D) Equivalent to Class 2.5 (ISO 14644-1)	P. 61	

RCA-SA4C

ROBO Cylinder, Slider Type, Actuator Width 40mm, 24V Servo Motor, Coupled Motor Specification

■ Model Specification Items	RCA	SA4C	Encoder type	20	Lead	Stroke	Applicable controller	Cable length	Options
	Series	Type	WA: Battery-less absolute	20: Servo motor 20W	10: 10mm 5: 5mm 2.5: 2.5mm	50: 50mm 400: 400mm (Can be set in 50mm increments)	A5: ACON-CB	N: No cable P: 1m S: 3m M: 5m X□□: Specified length R□□: Robot cable	Please refer to the options table below.

*Controller is not included.

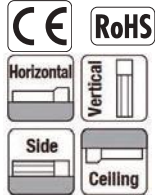

* Depending on the model, there may be some limitations to using the vertical, side, and ceiling mount positions. Please contact for more information regarding mounting positions.

High Accel./Decel. Option **Energy Saving Option**
(Excludes lead 2.5)



* This product is equipped with a slot for slider position adjustment (refer to the dimensional drawing on the right page) shown as A in the figure above.

POINT
Note on selection

- (1) The payload assumes operation at an acceleration of 0.3G (0.2G for lead 2.5) for standard and energy saving specifications, and 1G for high accel./decel. specification (excludes lead 2.5). (The values shown in the table below are the upper limit for the maximum payload even if acceleration/deceleration is decreased.)
- (2) Please refer to our website for more information about push-motion operation.

Actuator Specifications

Lead and Payload

Model number	Motor (W)	Lead (mm)	Maximum payload		Rated thrust (N)	Stroke (mm)
			Horizontal (kg)	Vertical (kg)		
RCA-SA4C-①-20-10-②-③-④-⑤	20	10	4	1	19.6	50~400 (Every 50mm)
RCA-SA4C-①-20-5-②-③-④-⑤		5	6	2.5	39.2	
RCA-SA4C-①-20-2.5-②-③-④-⑤		2.5	8	4.5	78.4	

Legend: ① Encoder type ② Stroke ③ Applicable controller ④ Cable length ⑤ Options

Stroke and Maximum Speed

Lead	Stroke	50~400
		(Every 50mm)
10		665
5		330
2.5		165

(Unit: mm/s)

① Encoder Type / ② Stroke

Stroke (mm)	Standard price
	Encoder type Battery-less absolute WA
50	-
100	-
150	-
200	-
250	-
300	-
350	-
400	-

④ Cable Length

Type	Cable code	Standard price
Standard type	P (1m)	-
	S (3m)	-
	M (5m)	-
Special length	X06 (6m) ~X10 (10m)	-
	X11 (11m) ~X15 (15m)	-
	X16 (16m) ~X20 (20m)	-
Robot cable	R01 (1m) ~R03 (3m)	-
	R04 (4m) ~R05 (5m)	-
	R06 (6m) ~R10 (10m)	-
	R11 (11m) ~R15 (15m)	-
	R16 (16m) ~R20 (20m)	-

*Please refer to P. 73 for maintenance cables.

⑤ Options

Name	Option code	Reference page	Standard price
Brake	B	Please refer to our website for the details of the options.	-
Foot bracket	FT		-
High acceleration/deceleration	HA		-
Home check sensor	HS		-
Energy saving	LA		-
Non-motor end specification	NM		-
Slider roller specification	SR		-
Slider spacer	SS	-	

* High acceleration/deceleration option and slider roller option cannot be combined together.
* High acceleration/deceleration option cannot be chosen for lead 2.5

* High acceleration/deceleration option and energy saving option cannot be combined together.

Actuator Specifications

Item	Description
Drive system	Ball screw Ø8mm, rolled C10
Positioning repeatability	±0.02mm
Lost motion	0.1mm or less
Base	Material: Aluminum with white alumite treatment
Static allowable moment	Ma: 6.9N·m, Mb: 9.9N·m, Mc: 17.0N·m
Dynamic allowable moment (*)	Ma: 3.29N·m, Mb: 4.71N·m, Mc: 8.07N·m
Ambient operating temperature, humidity	0 to 40°C, 85% RH or less (Non-condensing)

*Reference for overhang load length/Ma: 120mm or less, Mb, Mc: 120mm or less
(*) Assumes a standard rated life of 5,000km. The operational life will vary depending on operation and installation conditions.
Please refer to our website for more information regarding the service life of the products, directions of the allowable moment, and overhang load length.

Dimensions

CAD drawings can be downloaded from our website, www.intelligentactuator.com



- *1 Connects the motor-encoder cable. Please refer to P. 73 for the details of the cables.
- *2 When the slider is returning to its home position, please be careful of interference from surrounding objects, as it will travel until it reaches the ME.
- ME: Mechanical end SE: Stroke end
- *3 Reference position used when calculating the Ma moment.

- *4 When the actuator is mounted only using the mounting holes on the top of the base, the base can be distorted, which could cause sliding error or abnormal noise. When using the mounting holes on the top of the base, please keep the stroke length less than 200mm.

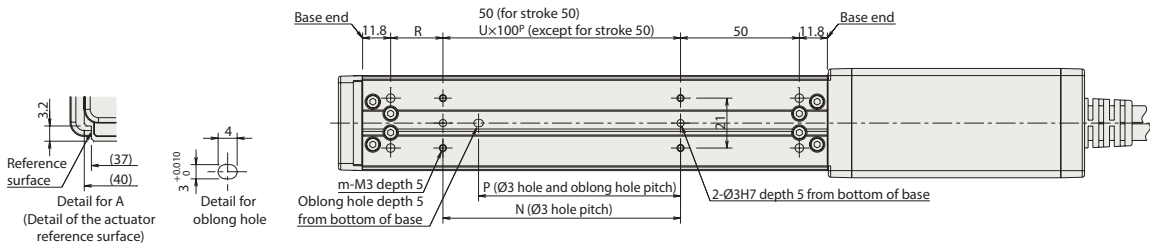
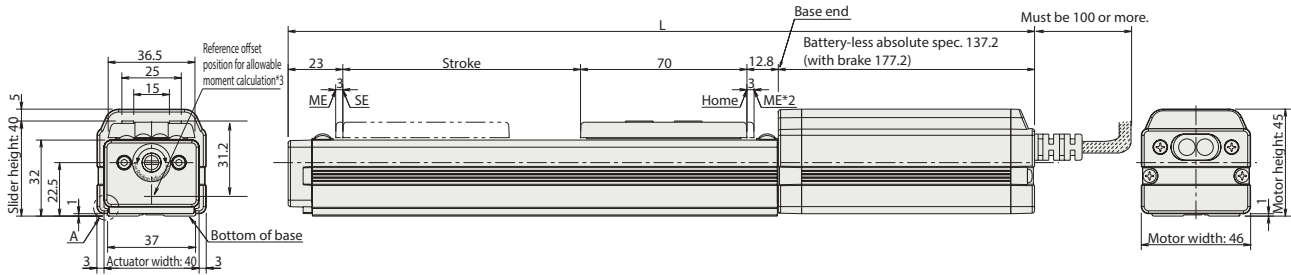
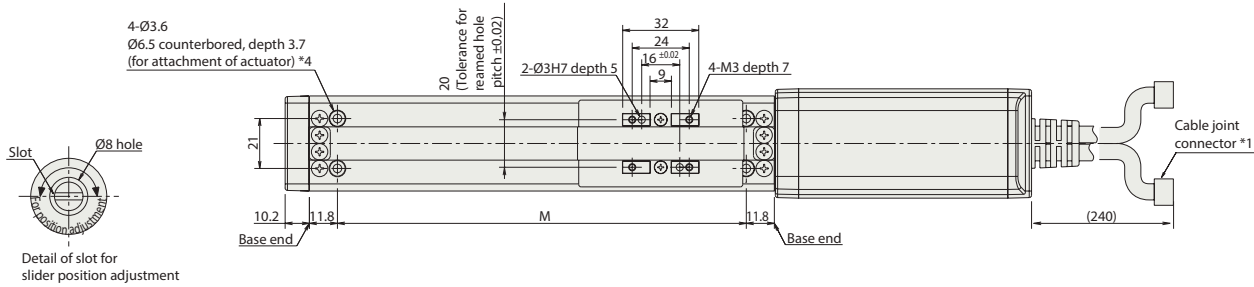

■ Dimensions and Mass by Stroke *Brake equipped types are 0.3kg heavier.

L	Stroke	Stroke							
		50	100	150	200	250	300	350	400
absolute	Without brake	293	343	393	443	493	543	593	643
	With brake	333	383	433	483	533	583	633	683
M		122	172	222	272	322	372	422	472
N		50	100	100	200	200	300	300	400
P		35	85	85	185	185	285	285	385
R		22	22	72	22	72	22	72	22
U		-	1	1	2	2	3	3	4
m		4	4	4	6	6	8	8	10
Mass (kg)		0.7	0.8	0.9	1	1.1	1.2	1.3	1.4

RCA-SA5C

ROBO Cylinder, Slider Type, Actuator Width 52mm, 24V Servo Motor, Coupled Motor Specification

Model Specification Items	RCA	SA5C	<input type="checkbox"/>	20	<input type="checkbox"/>	<input type="checkbox"/>	<input type="checkbox"/>	<input type="checkbox"/>	<input type="checkbox"/>
	Series	Type	Encoder type	Motor type	Lead	Stroke	Applicable controller	Cable length	Options
			WA: Battery-less absolute	20: Servo motor 20W	20: 20mm 12: 12mm 6: 6mm 3: 3mm	50: 50mm 1: 500: 500mm (Can be set in 50mm increments)	A5: ACON-CB	N: No cable P: 1m S: 3m M: 5m X <input type="checkbox"/> : Specified length R <input type="checkbox"/> : Robot cable	Please refer to the options table below.

*Controller is not included.

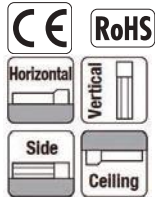

* Depending on the model, there may be some limitations to using the vertical, side, and ceiling mount positions. Please contact for more information regarding mounting positions.

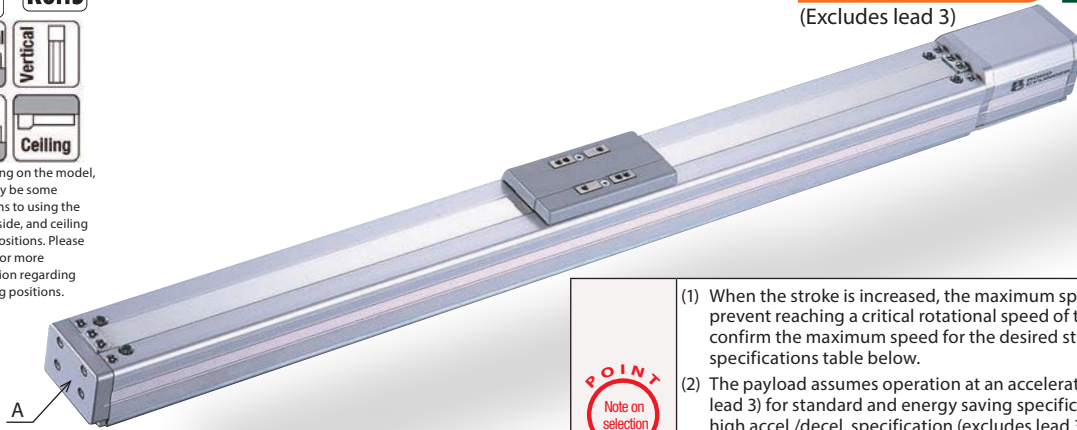

High Accel./Decel. Option (Excludes lead 3)
Energy Saving Option

* This product is equipped with a slot for slider position adjustment (refer to the dimensional drawing on the right page) shown as A in the figure above.

- (1) When the stroke is increased, the maximum speed will drop to prevent reaching a critical rotational speed of the ball screw. Please confirm the maximum speed for the desired stroke in the actuator specifications table below.
- (2) The payload assumes operation at an acceleration of 0.3G (0.2G for high accel./decel. specification (excludes lead 3). (The values shown in the table below are the upper limit for the maximum payload even if acceleration/deceleration is decreased.)
- (3) Please refer to our website for more information about push-motion operation.

Actuator Specifications

Lead and Payload

Model number	Motor (W)	Lead (mm)	Maximum payload		Rated thrust (N)	Stroke (mm)
			Horizontal (kg)	Vertical (kg)		
RCA-SA5C-①-20-20-②-③-④-⑤	20	20	2	0.5	10.7	50~500 (Every 50mm)
RCA-SA5C-①-20-12-②-③-④-⑤		12	4	1	16.7	
RCA-SA5C-①-20-6-②-③-④-⑤		6	8	2	33.3	
RCA-SA5C-①-20-3-②-③-④-⑤		3	12	4	65.7	

Legend: ① Encoder type ② Stroke ③ Applicable controller ④ Cable length ⑤ Options

Stroke and Maximum Speed

Stroke Lead	50~450 (Every 50mm)	500 (mm)
	20	1300 <800>
12	800	760
6	400	380
3	200	190

*Values in brackets < > are for vertical use. (Unit: mm/s)

① Encoder Type / ② Stroke

Stroke (mm)	Standard price	
	Encoder type	Battery-less absolute
	WA	
50	-	-
100	-	-
150	-	-
200	-	-
250	-	-
300	-	-
350	-	-
400	-	-
450	-	-
500	-	-

④ Cable Length

Type	Cable code	Standard price
Standard type	P (1m)	-
	S (3m)	-
	M (5m)	-
Special length	X06 (6m) ~X10 (10m)	-
	X11 (11m) ~X15 (15m)	-
	X16 (16m) ~X20 (20m)	-
Robot cable	R01 (1m) ~R03 (3m)	-
	R04 (4m) ~R05 (5m)	-
	R06 (6m) ~R10 (10m)	-
	R11 (11m) ~R15 (15m)	-
	R16 (16m) ~R20 (20m)	-

*Please refer to P. 73 for maintenance cables.

⑤ Options

Name	Option code	Reference page	Standard price
Brake	B	Please refer to our website for the details of the options.	-
Foot bracket	FT		-
High acceleration/deceleration	HA		-
Home check sensor	HS		-
Energy saving	LA		-
Non-motor end specification	NM		-
Slider roller specification	SR		-

* High acceleration/deceleration option and slider roller option cannot be combined together.

* High acceleration/deceleration option cannot be chosen for lead 3

* High acceleration/deceleration option and energy saving option cannot be combined together.

Actuator Specifications

Item	Description
Drive system	Ball screw Ø10mm, rolled C10
Positioning repeatability (*1)	±0.02mm [±0.03mm]
Lost motion	0.1mm or less
Base	Material: Aluminum with white alumite treatment
Static allowable moment	Ma: 18.6N·m, Mb: 26.6N·m, Mc: 47.5N·m
Dynamic allowable moment (*2)	Ma: 5.81N·m, Mb: 8.30N·m, Mc: 14.8N·m
Ambient operating temperature, humidity	0 to 40°C, 85% RH or less (Non-condensing)

*Reference for overhang load length/Ma: 150mm or less, Mb, Mc: 150mm or less

(*1) The value in [] applies when the lead is 20mm.

(*2) Assumes a standard rated life of 5,000km. The operational life will vary depending on operation and installation conditions.

Please refer to our website for more information regarding the service life of the products, directions of the allowable moment, and overhang load length.

Dimensions

CAD drawings can be downloaded from our website, www.intelligentactuator.com



- *1 Connects the motor-encoder cable. Please refer to P. 73 for the details of the cables.
- *2 When the slider is returning to its home position, please be careful of interference from surrounding objects, as it will travel until it reaches the ME.
- ME: Mechanical end SE: Stroke end
- *3 Reference position used when calculating the Ma moment.

- *4 When the actuator is mounted only using the mounting holes on the top of the base, the base can be distorted, which could cause sliding error or abnormal noise. When using the mounting holes on the top of the base, please keep the stroke length less than 300mm.

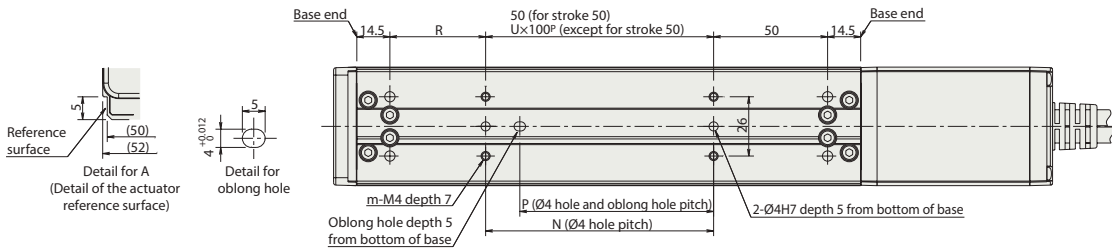
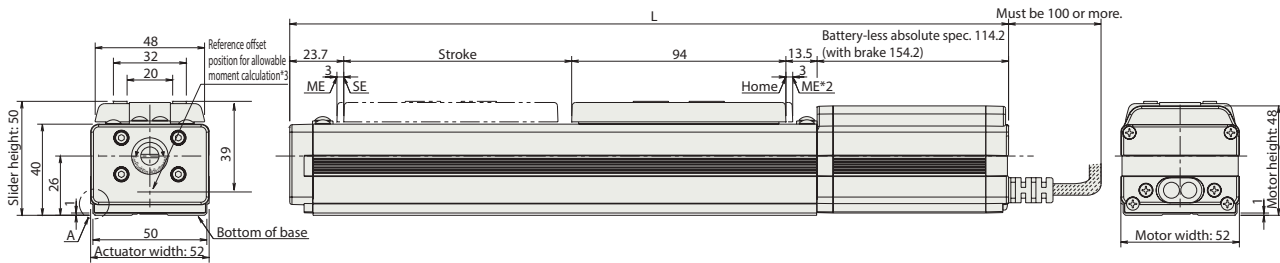
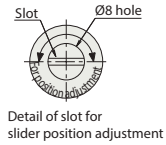
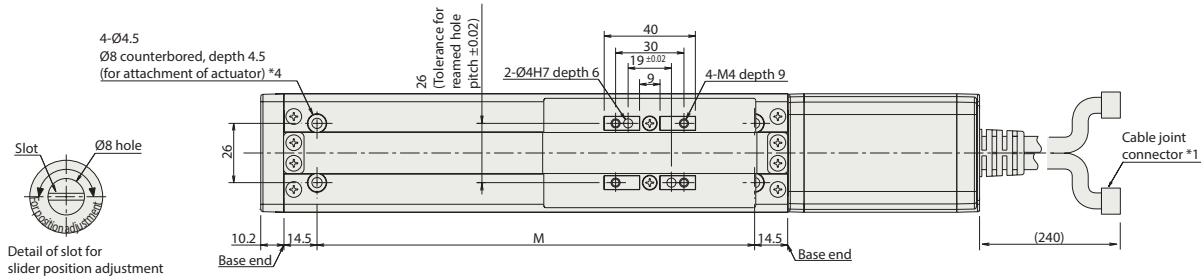

■ Dimensions and Mass by Stroke *Brake equipped types are 0.3kg heavier.

L	Stroke		50	100	150	200	250	300	350	400	450	500
	Battery-less absolute	With brake	295.4	345.4	395.4	445.4	495.4	545.4	595.4	645.4	695.4	745.4
M	142	192	242	292	342	392	442	492	542	592	642	692
N	50	100	100	200	200	300	300	400	400	500	500	500
P	35	85	85	185	185	285	285	385	385	485	485	485
R	42	42	92	42	92	42	92	42	92	42	92	42
U	-	1	1	2	2	3	3	4	4	5	5	5
m	4	4	4	6	6	8	8	10	10	12	12	12
Mass (kg)	1.3	1.4	1.5	1.6	1.7	1.8	1.9	2	2.1	2.2	2.2	2.2

RCA-SA6C

ROBO Cylinder, Slider Type, Actuator Width 58mm, 24V Servo Motor, Coupled Motor Specification

Model Specification Items	RCA	SA6C	<input type="checkbox"/>	30	<input type="checkbox"/>	<input type="checkbox"/>	<input type="checkbox"/>	<input type="checkbox"/>	<input type="checkbox"/>
	Series	Type	Encoder type	Motor type	Lead	Stroke	Applicable controller	Cable length	Options
			WA : Battery-less absolute	30 : Servo motor 30W	20 : 20mm 12 : 12mm 6 : 6mm 3 : 3mm	50 : 50mm 600 : 600mm (Can be set in 50mm increments)	A5 : ACON-CB	N : No cable P : 1m S : 3m M : 5m X <input type="checkbox"/> : Specified length R <input type="checkbox"/> : Robot cable	Please refer to the options table below.

*Controller is not included.

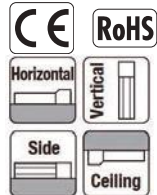

* Depending on the model, there may be some limitations to using the vertical, side, and ceiling mount positions. Please contact for more information regarding mounting positions.

High Accel./Decel. Option (Excludes lead 3)
Energy Saving Option



* This product is equipped with a slot for slider position adjustment (refer to the dimensional drawing on the right page) shown as A in the figure above.

- POINT**
Note on selection
- When the stroke is increased, the maximum speed will drop to prevent reaching a critical rotational speed of the ball screw. Please confirm the maximum speed for the desired stroke in the actuator specifications table below.
 - The payload assumes operation at an acceleration of 0.3G (0.2G for lead 3) for standard and energy saving specifications, and 1G for high accel./decel. specification (excludes lead 3). (The values shown in the table below are the upper limit for the maximum payload even if acceleration/deceleration is decreased.)
 - Please refer to our website for more information about push-motion operation.

Actuator Specifications

Lead and Payload

Model number	Motor (W)	Lead (mm)	Maximum payload		Rated thrust (N)	Stroke (mm)
			Horizontal (kg)	Vertical (kg)		
RCA-SA6C-①-30-20-②-③-④-⑤	30	20	3	0.5	15.8	50~600 (Every 50mm)
RCA-SA6C-①-30-12-②-③-④-⑤		12	6	1.5	24.2	
RCA-SA6C-①-30-6-②-③-④-⑤		6	12	3	48.4	
RCA-SA6C-①-30-3-②-③-④-⑤		3	18	6	96.8	

Legend: ① Encoder type ② Stroke ③ Applicable controller ④ Cable length ⑤ Options

Stroke and Maximum Speed

Stroke / Lead	50~450 (Every 50mm)	500	550	600
	(mm)	(mm)	(mm)	(mm)
20	1300 <800>	1160 <800>	990 <800>	
12	800	760	640	540
6	400	380	320	270
3	200	190	160	135

*Values in brackets < > are for vertical use. (Unit: mm/s)

① Encoder Type / ② Stroke

Stroke (mm)	Standard price	
	Encoder type	Battery-less absolute
	WA	
50	-	-
100	-	-
150	-	-
200	-	-
250	-	-
300	-	-
350	-	-
400	-	-
450	-	-
500	-	-
550	-	-
600	-	-

⑤ Options

Name	Option code	Reference page	Standard price
Brake	B	Please refer to our website for the details of the options.	-
Foot bracket	FT		-
High acceleration/deceleration	HA		-
Home check sensor	HS		-
Energy saving	LA		-
Non-motor end specification	NM		-
Slider roller specification	SR		-

* High acceleration/deceleration option and slider roller option cannot be combined together.

* High acceleration/deceleration option cannot be chosen for lead 3

* High acceleration/deceleration option and energy saving option cannot be combined together.

④ Cable Length

Type	Cable code	Standard price
Standard type	P (1m)	-
	S (3m)	-
	M (5m)	-
Special length	X06 (6m) ~ X10 (10m)	-
	X11 (11m) ~ X15 (15m)	-
	X16 (16m) ~ X20 (20m)	-
Robot cable	R01 (1m) ~ R03 (3m)	-
	R04 (4m) ~ R05 (5m)	-
	R06 (6m) ~ R10 (10m)	-
	R11 (11m) ~ R15 (15m)	-
	R16 (16m) ~ R20 (20m)	-

*Please refer to P. 73 for maintenance cables.

Actuator Specifications

Item	Description
Drive system	Ball screw Ø10mm, rolled C10
Positioning repeatability (*1)	±0.02mm [±0.03mm]
Lost motion	0.1mm or less
Base	Material: Aluminum with white alumite treatment
Static allowable moment	Ma: 38.3N·m, Mb: 54.7N·m, Mc: 81.0N·m
Dynamic allowable moment (*2)	Ma: 11.6N·m, Mb: 16.6N·m, Mc: 24.6N·m
Ambient operating temperature, humidity	0 to 40°C, 85% RH or less (Non-condensing)

*Reference for overhang load length/Ma: 220mm or less, Mb, Mc: 220mm or less

(*1) The value in [] applies when the lead is 20mm.

(*2) Assumes a standard rated life of 5,000km. The operational life will vary depending on operation and installation conditions.

Please refer to our website for more information regarding the service life of the products, directions of the allowable moment, and overhang load length.

Dimensions

CAD drawings can be downloaded from our website, www.intelligentactuator.com



- *1 Connects the motor-encoder cable. Please refer to P. 73 for the details of the cables.
- *2 When the slider is returning to its home position, please be careful of interference from surrounding objects, as it will travel until it reaches the ME.
- ME: Mechanical end SE: Stroke end
- *3 Reference position used when calculating the Ma moment.

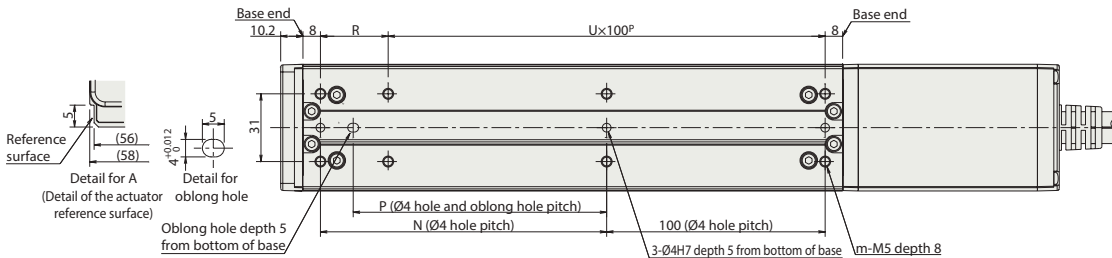
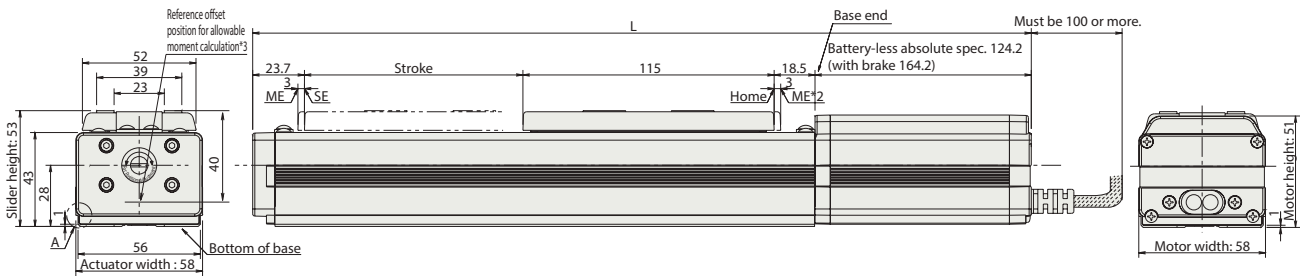
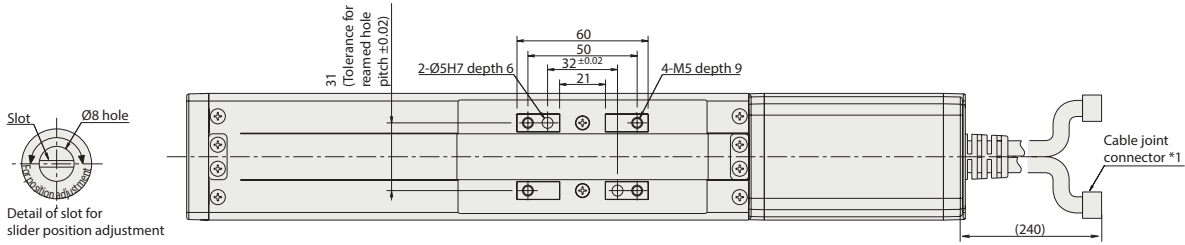

■ Dimensions and Mass by Stroke *Brake equipped types are 0.3kg heavier.

L	Stroke		50	100	150	200	250	300	350	400	450	500	550	600
	Battery-less absolute	Without brake	With brake	331.4	381.4	431.4	481.4	531.4	581.4	631.4	681.4	731.4	781.4	831.4
			371.4	421.4	471.4	521.4	571.4	621.4	671.4	721.4	771.4	821.4	871.4	921.4
	N		81	131	181	231	281	331	381	431	481	531	581	631
	P		66	116	166	216	266	316	366	416	466	516	566	616
	R		81	31	81	31	81	31	81	31	81	31	81	31
	U		1	2	2	3	3	4	4	5	5	6	6	7
	m		6	8	8	10	10	12	12	14	14	16	16	18
	Mass (kg)		1.4	1.6	1.8	2	2.2	2.4	2.6	2.8	3	3.2	3.4	3.6

RCA-SA4R

ROBO Cylinder, Slider Type, Actuator Width 40mm, 24V Servo Motor, Side-mounted Motor Specification

Model Specification Items	RCA	SA4R	<input type="checkbox"/>	20	<input type="checkbox"/>	<input type="checkbox"/>	<input type="checkbox"/>	<input type="checkbox"/>	<input type="checkbox"/>
	Series	Type	Encoder type	Motor type	Lead	Stroke	Applicable controller	Cable length	Options
			WA: Battery-less absolute	20: Servo motor 20W	10: 10mm 5: 5mm 2.5: 2.5mm	50: 50mm 400: 400mm (Can be set in 50mm increments)	A5: ACON-CB	N: No cable P: 1m S: 3m M: 5m X <input type="checkbox"/> : Specified length R <input type="checkbox"/> : Robot cable	Please refer to the options table below. * Please specify which side the motor is to be mounted (ML/MR)

*Controller is not included.



* Depending on the model, there may be some limitations to using the vertical, side, and ceiling mount positions. Please contact for more information regarding mounting positions.

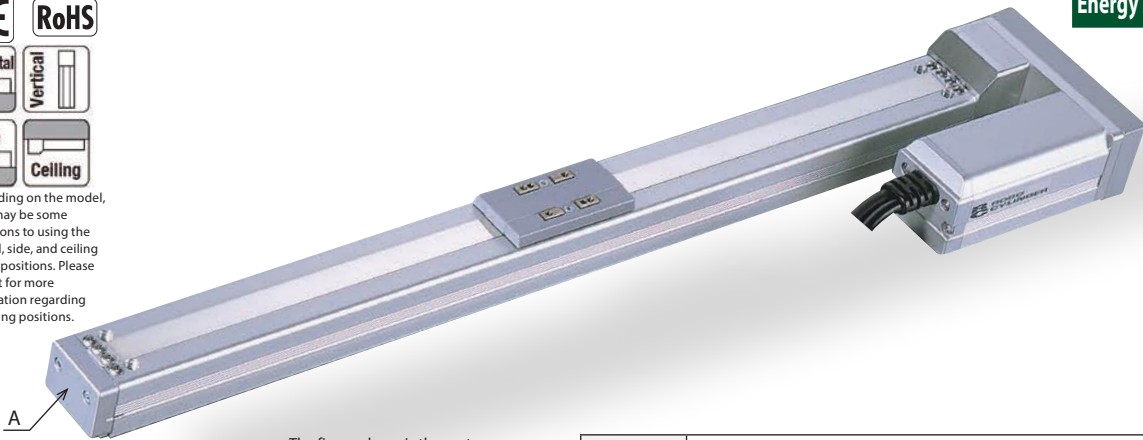

The figure above is the motor side-mounted to the left (ML).

* This product is equipped with a slot for slider position adjustment (refer to the dimensional drawing on the right page) shown as A in the figure above.

POINT
Note on selection

(1) The payload assumes operation at an acceleration of 0.3G (0.2G for lead 2.5). This is the upper limit of the acceleration.
(2) Please refer to our website for more information about push-motion operation.

Actuator Specifications

Lead and Payload

Model number	Motor (W)	Lead (mm)	Maximum payload		Rated thrust (N)	Stroke (mm)
			Horizontal (kg)	Vertical (kg)		
RCA-SA4R-①-20-10-②-③-④-⑤	20	10	4	1	19.6	50~400 (Every 50mm)
RCA-SA4R-①-20-5-②-③-④-⑤		5	6	2.5	39.2	
RCA-SA4R-①-20-2.5-②-③-④-⑤		2.5	8	4.5	78.4	

Legend: ① Encoder type ② Stroke ③ Applicable controller ④ Cable length ⑤ Options

Stroke and Maximum Speed

Lead	Stroke	50~400
		(Every 50mm)
10		665
5		330
2.5		165

(Unit: mm/s)

① Encoder Type / ② Stroke

Stroke (mm)	Standard price
	Encoder type
	Battery-less absolute
	WA
50	-
100	-
150	-
200	-
250	-
300	-
350	-
400	-

④ Cable Length

Type	Cable code	Standard price
Standard type	P (1m)	-
	S (3m)	-
	M (5m)	-
Special length	X06 (6m) ~X10 (10m)	-
	X11 (11m) ~X15 (15m)	-
	X16 (16m) ~X20 (20m)	-
	R01 (1m) ~R03 (3m)	-
Robot cable	R04 (4m) ~R05 (5m)	-
	R06 (6m) ~R10 (10m)	-
	R11 (11m) ~R15 (15m)	-
	R16 (16m) ~R20 (20m)	-

*Please refer to P. 73 for maintenance cables.

⑤ Options

Name	Option code	Reference page	Standard price
Brake	B		-
Home check sensor	HS		-
Energy saving	LA	Please refer to our website for the details of the options.	-
Non-motor end specification	NM		-
Motor side-mounted to the left (Standard)	ML		-
Motor side-mounted to the right	MR		-
Slider roller specification	SR		-
Slider spacer	SS		-

Actuator Specifications

Item	Description
Drive system	Ball screw Ø8mm, rolled C10
Positioning repeatability	±0.02mm
Lost motion	0.1mm or less
Base	Material: Aluminum with white alumite treatment
Static allowable moment	Ma: 6.9N·m, Mb: 9.9N·m, Mc: 17.0N·m
Dynamic allowable moment (*)	Ma: 3.29N·m, Mb: 4.71N·m, Mc: 8.07N·m
Ambient operating temperature, humidity	0 to 40°C, 85% RH or less (Non-condensing)

*Reference for overhang load length/Ma: 120mm or less, Mb, Mc: 120mm or less
(*) Assumes a standard rated life of 5,000km. The operational life will vary depending on operation and installation conditions.

Please refer to our website for more information regarding the service life of the products, directions of the allowable moment, and overhang load length.

Dimensions

CAD drawings can be downloaded from our website, www.intelligentactuator.com

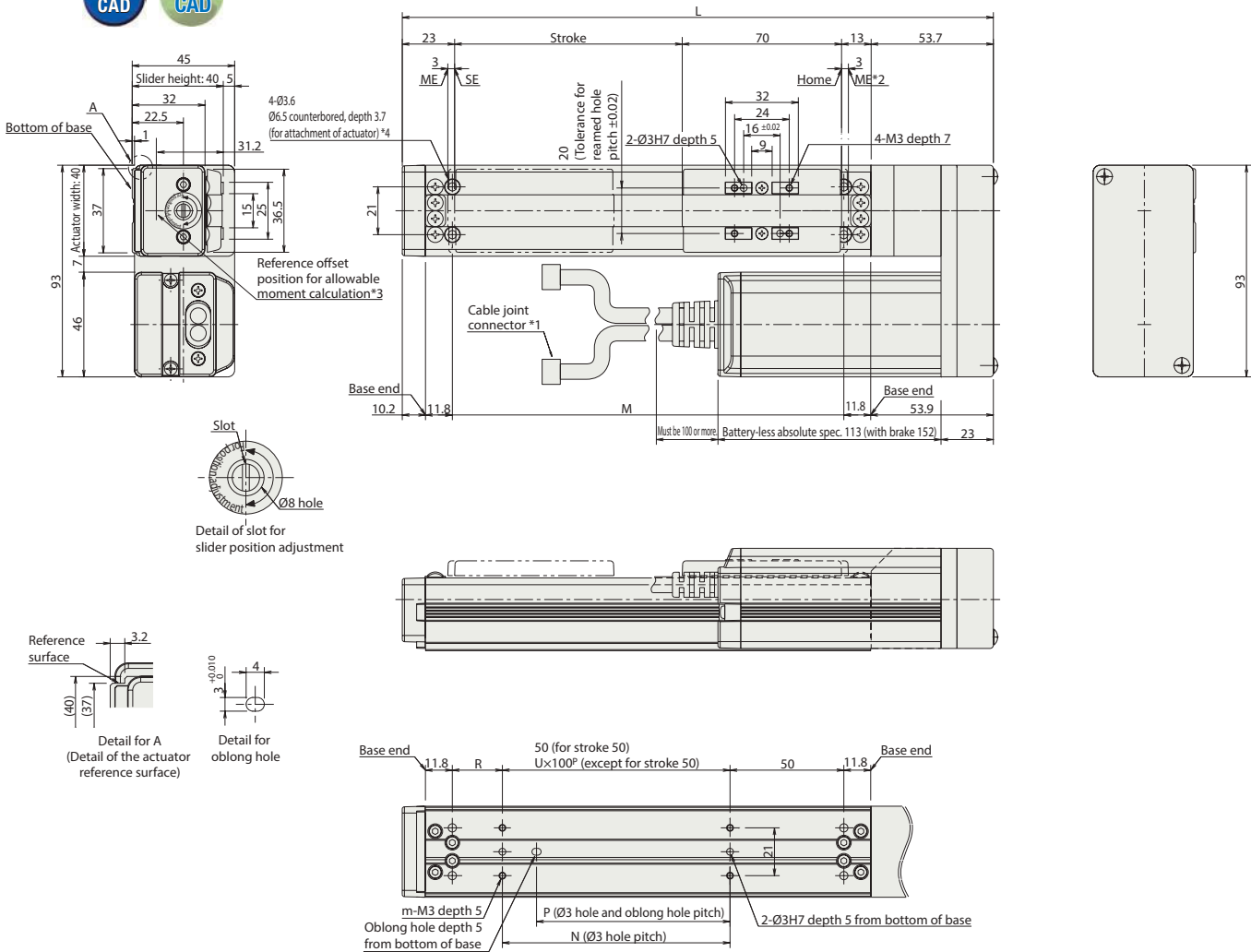

*1 Connects the motor-encoder cable. Please refer to P.73 for the details of the cables.
 *2 When the slider is returning to its home position, please be careful of interference from surrounding objects, as it will travel until it reaches the ME.
 ME: Mechanical end SE: Stroke end
 *3 Reference position used when calculating the Ma moment.
 *4 When the actuator is mounted only using the mounting holes on the top of the base, the base can be distorted, which could cause sliding error or abnormal noise. When using the mounting holes on the top of the base, please keep the stroke length less than 200mm.

■Dimensions and Mass by Stroke *Brake equipped types are 0.3kg heavier.

Stroke	50	100	150	200	250	300	350	400
L	209.7	259.7	309.7	359.7	409.7	459.7	509.7	559.7
M	122	172	222	272	322	372	422	472
N	50	100	100	200	200	300	300	400
P	35	85	85	185	185	285	285	385
R	22	22	72	22	72	22	72	22
U	-	1	1	2	2	3	3	4
m	4	4	4	6	6	8	8	10
Mass (kg)	0.8	0.9	1.0	1.1	1.2	1.3	1.4	1.5

RCA-SA5R

ROBO Cylinder, Slider Type, Actuator Width 52mm, 24V Servo Motor, Side-mounted Motor Specification

Model Specification Items	RCA	SA5R	<input type="checkbox"/>	20	<input type="checkbox"/>	<input type="checkbox"/>	<input type="checkbox"/>	<input type="checkbox"/>	<input type="checkbox"/>
	Series	Type	Encoder type	Motor type	Lead	Stroke	Applicable controller	Cable length	Options
			WA: Battery-less absolute	20: Servo motor 20W	12: 12mm 6: 6mm 3: 3mm	50: 50mm 500: 500mm (Can be set in 50mm increments)	A5: ACON-CB	N: No cable P: 1m S: 3m M: 5m X <input type="checkbox"/> : Specified length R <input type="checkbox"/> : Robot cable	Please refer to the options table below. * Please specify which side the motor is to be mounted (ML/MR)

*Controller is not included.

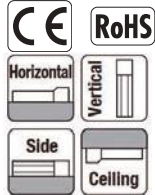

* Depending on the model, there may be some limitations to using the vertical, side, and ceiling mount positions. Please contact for more information regarding mounting positions.

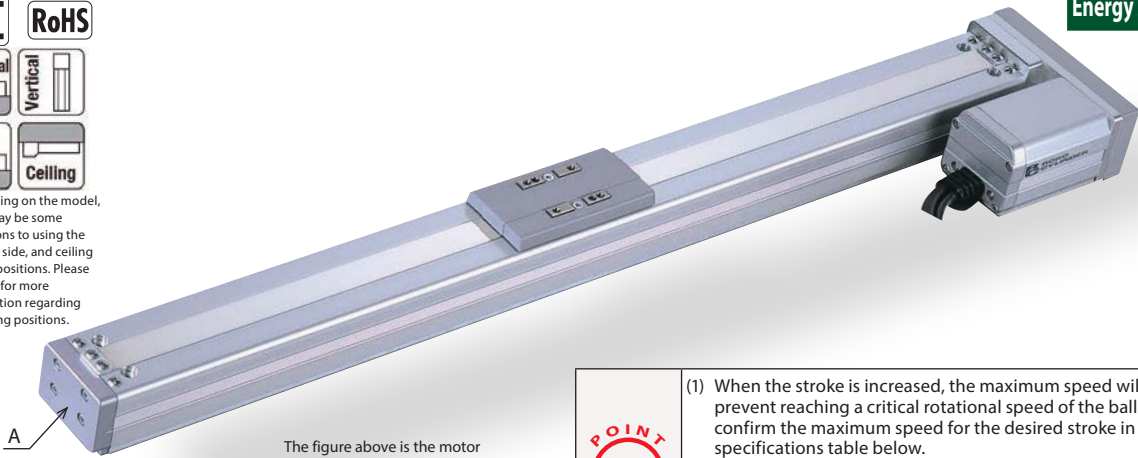

The figure above is the motor side-mounted to the left (ML).

* This product is equipped with a slot for slider position adjustment (refer to the dimensional drawing on the right page) shown as A in the figure above.

- POINT**
Note on selection
- When the stroke is increased, the maximum speed will drop to prevent reaching a critical rotational speed of the ball screw. Please confirm the maximum speed for the desired stroke in the actuator specifications table below.
 - The payload assumes operation at an acceleration of 0.3G (0.2G for lead 3). This is the upper limit of the acceleration.
 - Please refer to our website for more information about push-motion operation.

Actuator Specifications

Lead and Payload

Model number	Motor (W)	Lead (mm)	Maximum payload		Rated thrust (N)	Stroke (mm)
			Horizontal (kg)	Vertical (kg)		
RCA-SA5R-①-20-12-②-③-④-⑤	20	12	4	1	16.7	50~500 (Every 50mm)
RCA-SA5R-①-20-6-②-③-④-⑤		6	8	2	33.3	
RCA-SA5R-①-20-3-②-③-④-⑤		3	12	4	65.7	

Legend: ① Encoder type ② Stroke ③ Applicable controller ④ Cable length ⑤ Options

Stroke and Maximum Speed

Stroke / Lead	50~450 (Every 50mm)	500 (mm)
	12	800
6	400	380
3	200	190

(Unit: mm/s)

① Encoder Type / ② Stroke

Stroke (mm)	Standard price
	Encoder type
	Battery-less absolute
	WA
50	-
100	-
150	-
200	-
250	-
300	-
350	-
400	-
450	-
500	-

④ Cable Length

Type	Cable code	Standard price
Standard type	P (1m)	-
	S (3m)	-
	M (5m)	-
Special length	X06 (6m) ~X10 (10m)	-
	X11 (11m) ~X15 (15m)	-
	X16 (16m) ~X20 (20m)	-
	R01 (1m) ~R03 (3m)	-
Robot cable	R04 (4m) ~R05 (5m)	-
	R06 (6m) ~R10 (10m)	-
	R11 (11m) ~R15 (15m)	-
	R16 (16m) ~R20 (20m)	-

*Please refer to P. 73 for maintenance cables.

⑤ Options

Name	Option code	Reference page	Standard price
Brake	B	Please refer to our website for the details of the options.	-
Home check sensor	HS		-
Energy saving	LA		-
Non-motor end specification	NM		-
Motor side-mounted to the left (Standard)	ML		-
Motor side-mounted to the right	MR		-
Slider roller specification	SR	-	-

Actuator Specifications

Item	Description
Drive system	Ball screw Ø10mm, rolled C10
Positioning repeatability	±0.02mm
Lost motion	0.1mm or less
Base	Material: Aluminum with white alumite treatment
Static allowable moment	Ma: 18.6N·m, Mb: 26.6N·m, Mc: 47.5N·m
Dynamic allowable moment (*)	Ma: 5.81N·m, Mb: 8.30N·m, Mc: 14.8N·m
Ambient operating temperature, humidity	0 to 40°C, 85% RH or less (Non-condensing)

*Reference for overhang load length/Ma: 150mm or less, Mb, Mc: 150mm or less

(*) Assumes a standard rated life of 5,000km. The operational life will vary depending on operation and installation conditions.

Please refer to our website for more information regarding the service life of the products, directions of the allowable moment, and overhang load length.

Dimensions

CAD drawings can be downloaded from our website, www.intelligentactuator.com

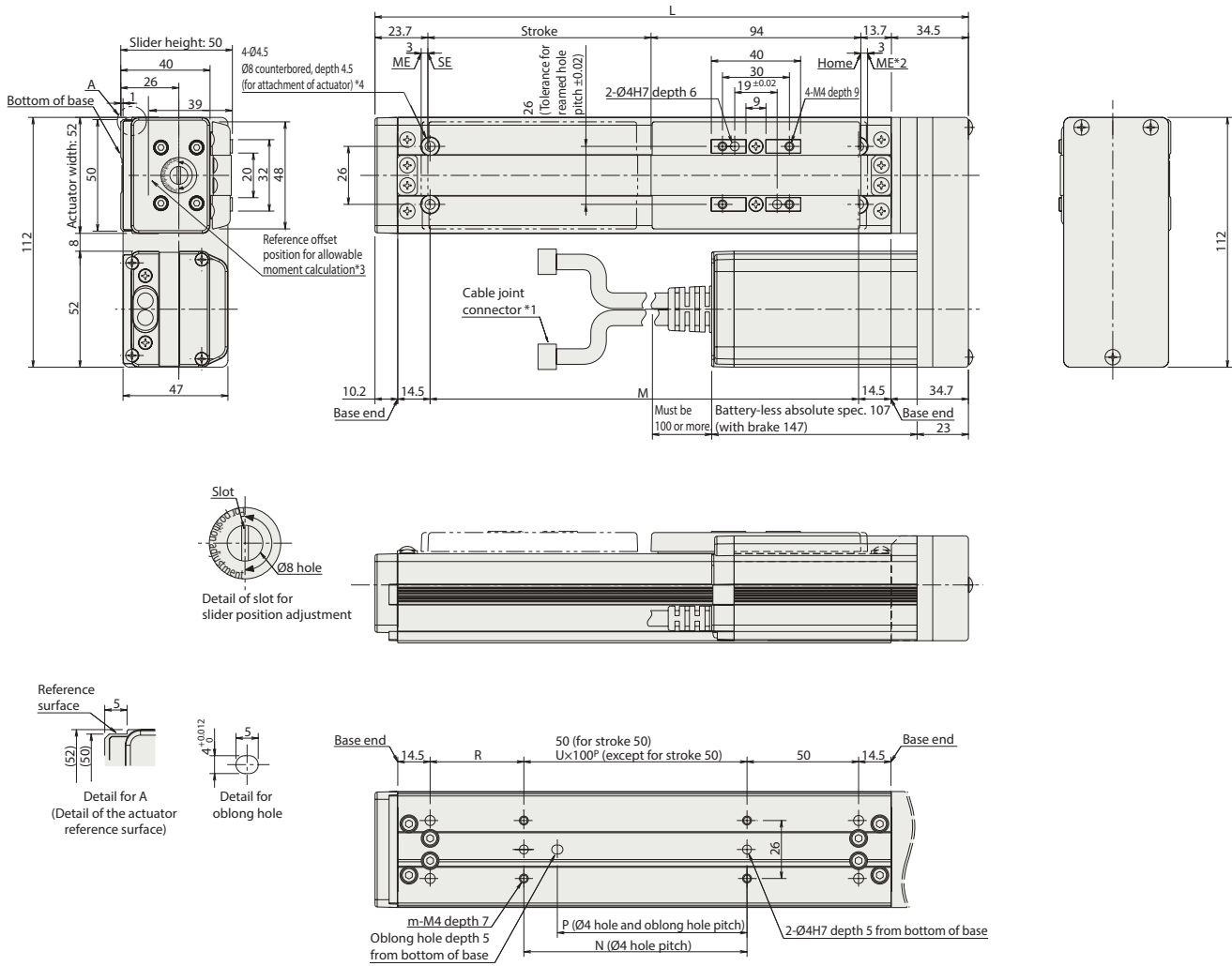

*1 Connects the motor-encoder cable. Please refer to P. 73 for the details of the cables.
 *2 When the slider is returning to its home position, please be careful of interference from surrounding objects, as it will travel until it reaches the ME.
 ME: Mechanical end SE: Stroke end
 *3 Reference position used when calculating the Ma moment.
 *4 When the actuator is mounted only using the mounting holes on the top of the base, the base can be distorted, which could cause sliding error or abnormal noise. When using the mounting holes on the top of the base, please keep the stroke length less than 300mm.

■ Dimensions and Mass by Stroke *Brake equipped types are 0.3kg heavier.

Stroke	50	100	150	200	250	300	350	400	450	500
L	215.9	265.9	315.9	365.9	415.9	465.9	515.9	565.9	615.9	665.9
M	142	192	242	292	342	392	442	492	542	592
N	50	100	100	200	200	300	300	400	400	500
P	35	85	85	185	185	285	285	385	385	485
R	42	42	92	42	92	42	92	42	92	42
U	-	1	1	2	2	3	3	4	4	5
m	4	4	4	6	6	8	8	10	10	12
Mass (kg)	1.5	1.6	1.7	1.8	1.9	2.0	2.1	2.2	2.3	2.4

RCA-SA6R

ROBO Cylinder, Slider Type, Actuator Width 58mm, 24V Servo Motor, Side-mounted Motor Specification

■ Model Specification Items	RCA	SA6R	Encoder type	30	Lead	Stroke	Applicable controller	Cable length	Options
	Series	Type	WA: Battery-less absolute	30: Servo motor 30W	12: 12mm 6: 6mm 3: 3mm	50: 50mm 600: 600mm (Can be set in 50mm increments)	A5: ACON-CB	N: No cable P: 1m S: 3m M: 5m X□□: Specified length R□□: Robot cable	Please refer to the options table below. * Please specify which side the motor is to be mounted (ML/MR)

*Controller is not included.

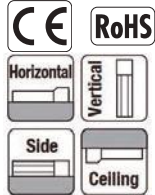

* Depending on the model, there may be some limitations to using the vertical, side, and ceiling mount positions. Please contact for more information regarding mounting positions.

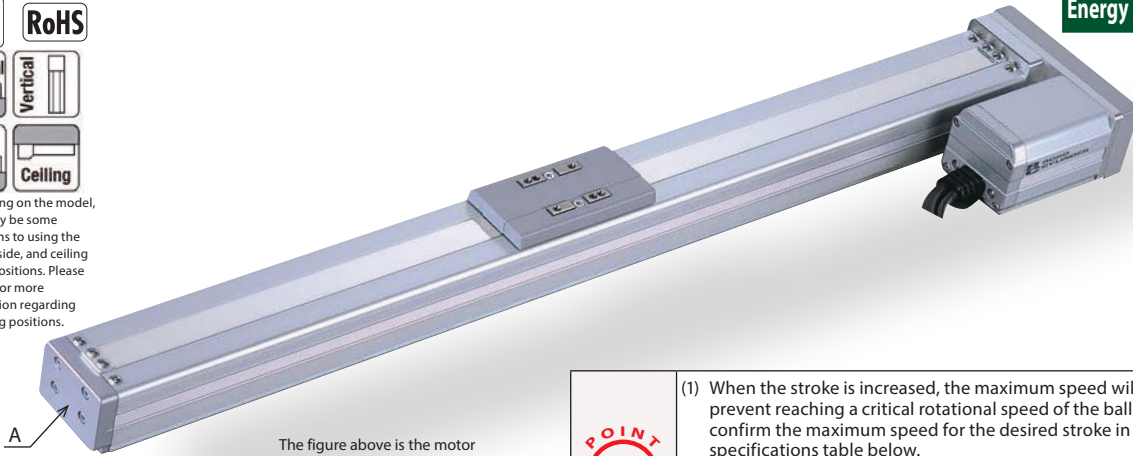

The figure above is the motor side-mounted to the left (ML).

* This product is equipped with a slot for slider position adjustment (refer to the dimensional drawing on the right page) shown as A in the figure above.

- POINT**
Note on selection
- When the stroke is increased, the maximum speed will drop to prevent reaching a critical rotational speed of the ball screw. Please confirm the maximum speed for the desired stroke in the actuator specifications table below.
 - The payload assumes operation at an acceleration of 0.3G (0.2G for lead 3). This is the upper limit of the acceleration.
 - Please refer to our website for more information about push-motion operation.

Actuator Specifications

■ Lead and Payload

Model number	Motor (W)	Lead (mm)	Maximum payload		Rated thrust (N)	Stroke (mm)
			Horizontal (kg)	Vertical (kg)		
RCA-SA6R-①-30-12-②-③-④-⑤	30	12	6	1.5	24.2	50~600 (Every 50mm)
RCA-SA6R-①-30-6-②-③-④-⑤		6	12	3	48.4	
RCA-SA6R-①-30-3-②-③-④-⑤		3	18	6	96.8	

Legend: ① Encoder type ② Stroke ③ Applicable controller ④ Cable length ⑤ Options

■ Stroke and Maximum Speed

Stroke / Lead	50~450 (Every 50mm)	500 (mm)	550 (mm)	600 (mm)
	12	800	760	640
6	400	380	320	270
3	200	190	160	135

(Unit: mm/s)

① Encoder Type / ② Stroke

Stroke (mm)	Standard price	
	Encoder type	Battery-less absolute
50	-	WA
100	-	-
150	-	-
200	-	-
250	-	-
300	-	-
350	-	-
400	-	-
450	-	-
500	-	-
550	-	-
600	-	-

⑤ Options

Name	Option code	Reference page	Standard price
Brake	B	Please refer to our website for the details of the options.	-
Home check sensor	HS		-
Energy saving	LA		-
Non-motor end specification	NM		-
Motor side-mounted to the left (Standard)	ML		-
Motor side-mounted to the right	MR		-
Slider roller specification	SR		-

④ Cable Length

Type	Cable code	Standard price
Standard type	P (1m)	-
	S (3m)	-
	M (5m)	-
Special length	X06 (6m) ~X10 (10m)	-
	X11 (11m) ~X15 (15m)	-
	X16 (16m) ~X20 (20m)	-
	R01 (1m) ~R03 (3m)	-
Robot cable	R04 (4m) ~R05 (5m)	-
	R06 (6m) ~R10 (10m)	-
	R11 (11m) ~R15 (15m)	-
	R16 (16m) ~R20 (20m)	-
	-	-

*Please refer to P. 73 for maintenance cables.

Actuator Specifications

Item	Description
Drive system	Ball screw Ø10mm, rolled C10
Positioning repeatability	±0.02mm
Lost motion	0.1mm or less
Base	Material: Aluminum with white alumite treatment
Static allowable moment	Ma: 38.3N·m, Mb: 54.7N·m, Mc: 81.0N·m
Dynamic allowable moment (*)	Ma: 11.6N·m, Mb: 16.6N·m, Mc: 24.6N·m
Ambient operating temperature, humidity	0 to 40°C, 85% RH or less (Non-condensing)

*Reference for overhang load length/Ma: 220mm or less, Mb, Mc: 220mm or less
(*) Assumes a standard rated life of 5,000km. The operational life will vary depending on operation and installation conditions.

Please refer to our website for more information regarding the service life of the products, directions of the allowable moment, and overhang load length.

Dimensions

CAD drawings can be downloaded from our website, www.intelligentactuator.com

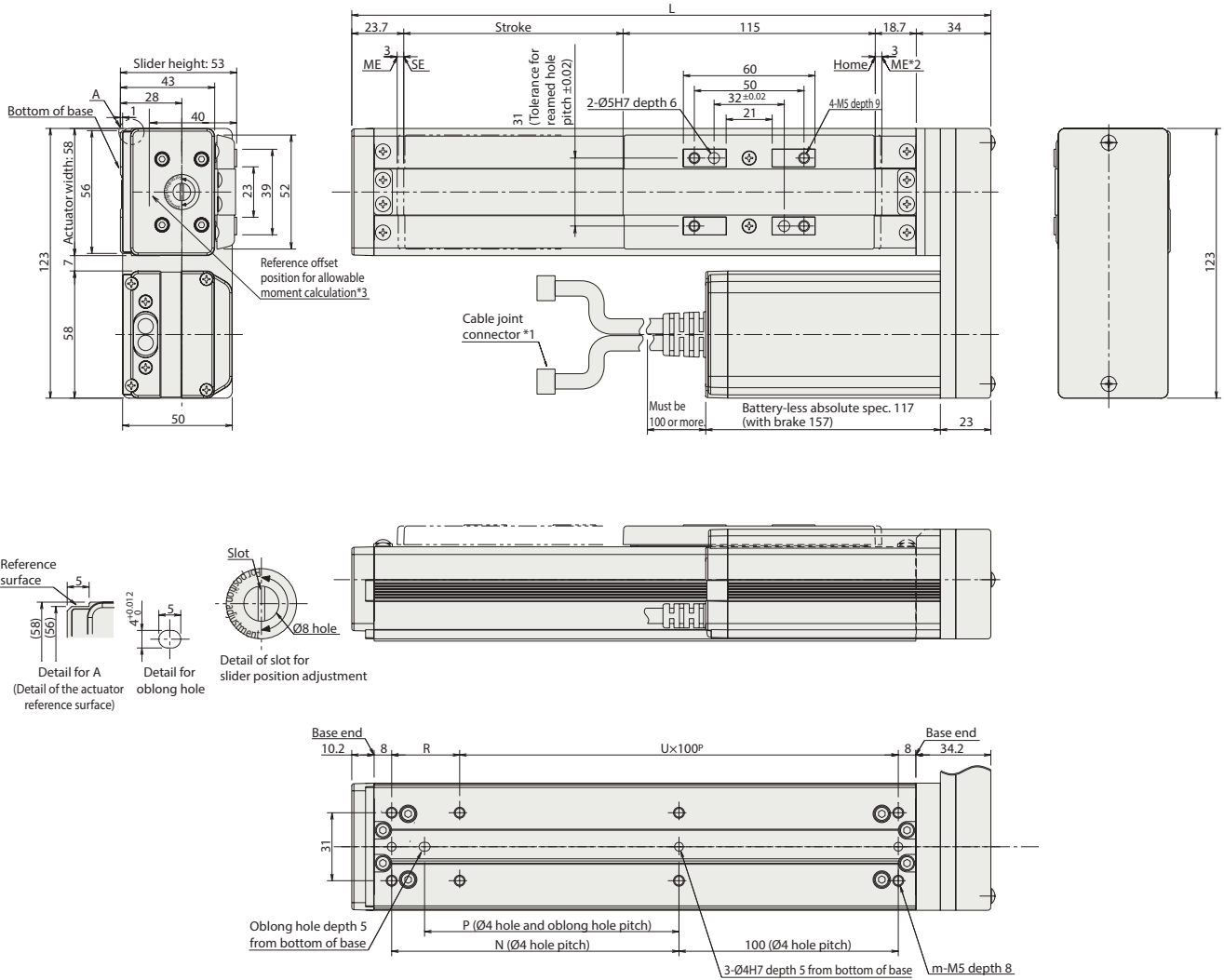

*1 Connects the motor-encoder cable. Please refer to P. 73 for the details of the cables.

*2 When the slider is returning to its home position, please be careful of interference from surrounding objects, as it will travel until it reaches the ME.
ME: Mechanical end SE: Stroke end

*3 Reference position used when calculating the Ma moment.

■ Dimensions and Mass by Stroke *Brake equipped types are 0.3kg heavier.

Stroke	50	100	150	200	250	300	350	400	450	500	550	600
L	241.4	291.4	341.4	391.4	441.4	491.4	541.4	591.4	641.4	691.4	741.4	791.4
N	81	131	181	231	281	331	381	431	481	531	581	631
P	66	116	166	216	266	316	366	416	466	516	566	616
R	81	31	81	31	81	31	81	31	81	31	81	31
U	1	2	2	3	3	4	4	5	5	6	6	7
m	6	8	8	10	10	12	12	14	14	16	16	18
Mass (kg)	1.7	1.9	2.1	2.3	2.5	2.7	2.9	3.1	3.3	3.5	3.7	3.9

RCS2-SA4C

ROBO Cylinder, Slider Type, Actuator Width 40mm, 200V Servo Motor, Coupled Motor Specification

Model Specification Items	RCS2	SA4C	<input type="checkbox"/>	20	<input type="checkbox"/>	<input type="checkbox"/>	<input type="checkbox"/>	<input type="checkbox"/>	<input type="checkbox"/>
	Series	Type	Encoder type	Motor type	Lead	Stroke	Applicable controller	Cable length	Options
			WA: Battery-less absolute	20: Servo motor 20W	16: 16mm 10: 10mm 5: 5mm 2.5: 2.5mm	50: 50mm 400: 400mm (Can be set in 50mm increments)	T2: SCON-CB	N: No cable P: 1m S: 3m M: 5m X <input type="checkbox"/> : Specified length R <input type="checkbox"/> : Robot cable	Please refer to the options table below.

*Controller is not included.



* CE marking is an option.

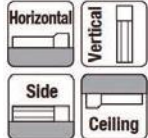

* Depending on the model, there may be some limitations to using the vertical, side, and ceiling mount positions. Please contact for more information regarding mounting positions.

High Accel./Decel. Option

(Excludes lead 2.5)

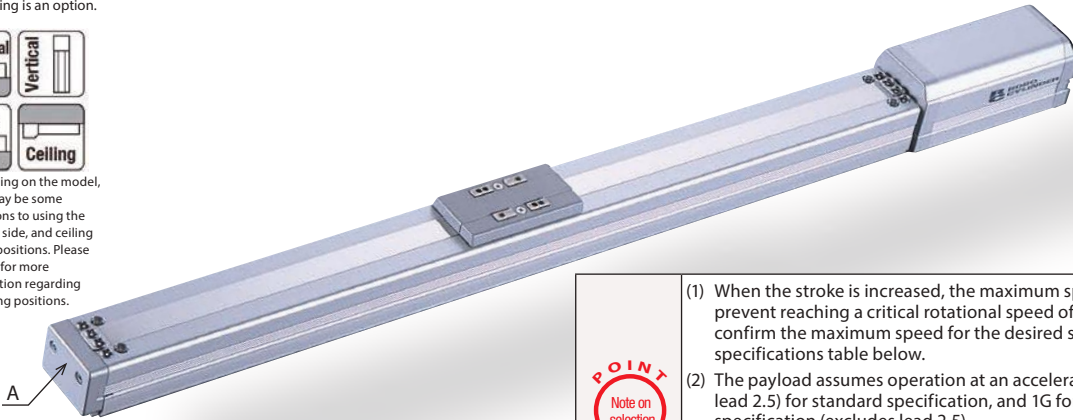

* This product is equipped with a slot for slider position adjustment (refer to the dimensional drawing on the right page) shown as A in the figure above.

POINT
Note on selection

- (1) When the stroke is increased, the maximum speed will drop to prevent reaching a critical rotational speed of the ball screw. Please confirm the maximum speed for the desired stroke in the actuator specifications table below.
- (2) The payload assumes operation at an acceleration of 0.3G (0.2G for lead 2.5) for standard specification, and 1G for high accel./decel. specification (excludes lead 2.5). (The values shown in the table below are the upper limit for the maximum payload even if acceleration/deceleration is decreased.)
- (3) Please refer to our website for more information about push-motion operation.

Actuator Specifications

Lead and Payload

Model number	Motor (W)	Lead (mm)	Maximum payload		Rated thrust (N)	Stroke (mm)
			Horizontal (kg)	Vertical (kg)		
RCS2-SA4C-①-20-16-②-③-④-⑤	20	16	2.5	0.6	12.25	50~400 (Every 50mm)
RCS2-SA4C-①-20-10-②-③-④-⑤		10	4	1	19.6	
RCS2-SA4C-①-20-5-②-③-④-⑤		5	6	2.5	39.2	
RCS2-SA4C-①-20-2.5-②-③-④-⑤		2.5	8	4.5	78.4	

Legend: ① Encoder type ② Stroke ③ Applicable controller ④ Cable length ⑤ Options

Stroke and Maximum Speed

Stroke Lead	50~400 (Every 50mm)	
	16	1,060
10	665	
5	330	
2.5	165	

(Unit: mm/s)

① Encoder Type / ② Stroke

Stroke (mm)	Standard price	
	Encoder type	Battery-less absolute
50	-	WA
100	-	-
150	-	-
200	-	-
250	-	-
300	-	-
350	-	-
400	-	-

④ Cable Length

Type	Cable code	Standard price
Standard type	P (1m)	-
	S (3m)	-
	M (5m)	-
Special length	X06 (6m) ~ X10 (10m)	-
	X11 (11m) ~ X15 (15m)	-
	X16 (16m) ~ X20 (20m)	-
Robot cable	R01 (1m) ~ R03 (3m)	-
	R04 (4m) ~ R05 (5m)	-
	R06 (6m) ~ R10 (10m)	-
	R11 (11m) ~ R15 (15m)	-
	R16 (16m) ~ R20 (20m)	-
	R21 (21m) ~ R25 (25m)	-

*Please refer to P. 84 for maintenance cables.

⑤ Options

Name	Option code	Reference page	Standard price
Brake	B	Please refer to our website for the details of the options.	-
CE marking	CE		-
Foot bracket	FT		-
High acceleration/deceleration	HA		-
Home check sensor	HS		-
Non-motor end specification	NM		-
Slider roller specification	SR		-
Slider spacer	SS		-

* High acceleration/deceleration option and slider roller option cannot be combined together.
* High acceleration/deceleration option cannot be chosen for lead 2.5.

Actuator Specifications

Item	Description
Drive system	Ball screw Ø8mm, rolled C10
Positioning repeatability	±0.02mm
Lost motion	0.1mm or less
Base	Material: Aluminum with white alumite treatment
Static allowable moment	Ma: 6.90N·m, Mb: 9.90N·m, Mc: 17.0N·m
Dynamic allowable moment (*)	Ma: 3.29N·m, Mb: 4.71N·m, Mc: 8.07N·m
Ambient operating temperature, humidity	0 to 40°C, 85% RH or less (Non-condensing)

*Reference for overhang load length/Ma: 120mm or less, Mb, Mc: 120mm or less
(*) Assumes a standard rated life of 5,000km. The operational life will vary depending on operation and installation conditions.
Please refer to our website for more information regarding the service life of the products, directions of the allowable moment, and overhang load length.

Dimensions

CAD drawings can be downloaded from our website, www.intelligentactuator.com



- *1 Connects the motor-encoder cable. Please refer to P.84 for the details of the cables.
- *2 When the slider is returning to its home position, please be careful of interference from surrounding objects, as it will travel until it reaches the ME.
- ME: Mechanical end SE: Stroke end
- *3 Reference position used when calculating the Ma moment.

- *4 When the actuator is mounted only using the mounting holes on the top of the base, the base can be distorted, which could cause sliding error or abnormal noise. When using the mounting holes on the top of the base, please keep the stroke length less than 200mm.

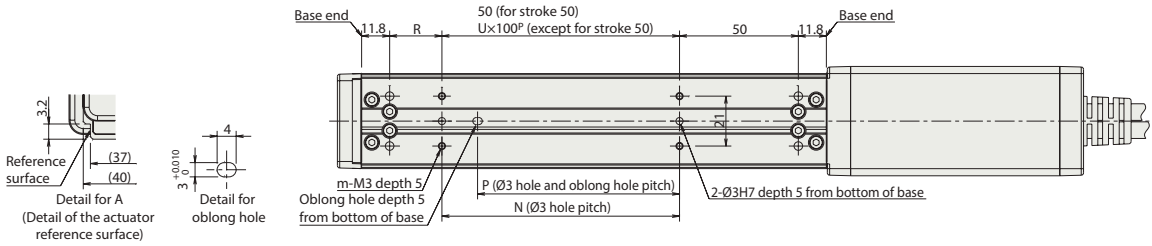
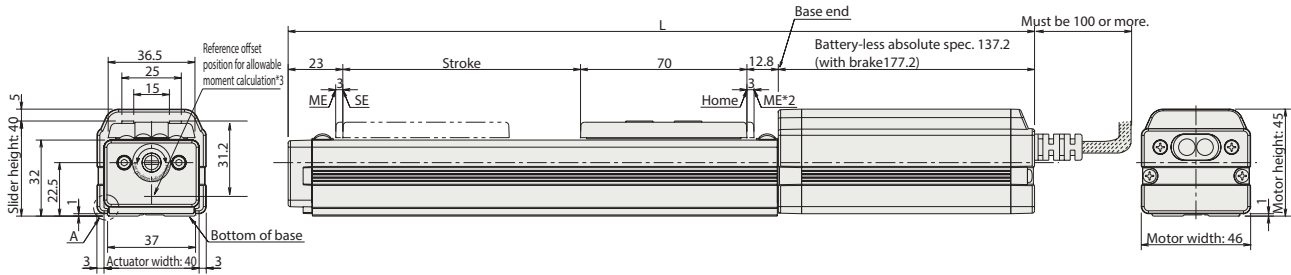
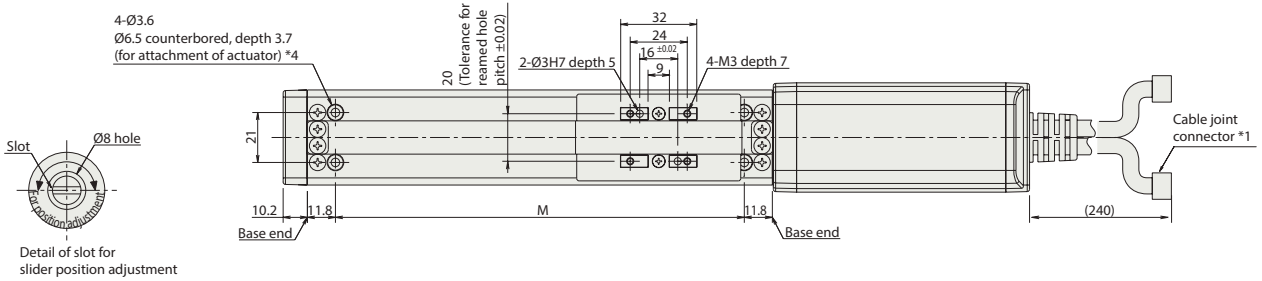

■Dimensions and Mass by Stroke *Brake equipped types are 0.3kg heavier.

L	Stroke		50	100	150	200	250	300	350	400
	Battery-less absolute	Without brake With brake	293	343	393	443	493	543	593	643
			333	383	433	483	533	583	633	683
	M		122	172	222	272	322	372	422	472
	N		50	100	100	200	200	300	300	400
	P		35	85	85	185	185	285	285	385
	R		22	22	72	22	72	22	72	22
	U		-	1	1	2	2	3	3	4
	m		4	4	4	6	6	8	8	10
	Mass (kg)		0.7	0.8	0.9	1	1.1	1.2	1.3	1.4

RCS2-SA5C

ROBO Cylinder, Slider Type, Actuator Width 52mm, 200V Servo Motor, Coupled Motor Specification

Model Specification Items	RCS2	SA5C	<input type="checkbox"/>	20	<input type="checkbox"/>	<input type="checkbox"/>	<input type="checkbox"/>	<input type="checkbox"/>	<input type="checkbox"/>
	Series	Type	Encoder type	Motor type	Lead	Stroke	Applicable controller	Cable length	Options
			WA: Battery-less absolute	20: Servo motor 20W	20: 20mm 12: 12mm 6: 6mm 3: 3mm	50: 50mm 1: 1mm 500: 500mm (Can be set in 50mm increments)	T2: SCON-CB	N: No cable P: 1m S: 3m M: 5m X <input type="checkbox"/> : Specified length R <input type="checkbox"/> : Robot cable	Please refer to the options table below.

*Controller is not included.



* CE marking is an option.

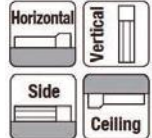

* Depending on the model, there may be some limitations to using the vertical, side, and ceiling mount positions. Please contact for more information regarding mounting positions.



* This product is equipped with a slot for slider position adjustment (refer to the dimensional drawing on the right page) shown as A in the figure above.

High Accel./Decel. Option

(Excludes lead 3)



- When the stroke is increased, the maximum speed will drop to prevent reaching a critical rotational speed of the ball screw. Please confirm the maximum speed for the desired stroke in the actuator specifications table below.
- The payload assumes operation at an acceleration of 0.3G (0.2G for lead 3) for standard specification, and 0.8G for high accel./decel. specification (excludes lead 3). (The values shown in the table below are the upper limit for the maximum payload even if acceleration/deceleration is decreased.)
- Please refer to our website for more information about push-motion operation.

Actuator Specifications

Lead and Payload

Model number	Motor (W)	Lead (mm)	Maximum payload		Rated thrust (N)	Stroke (mm)
			Horizontal (kg)	Vertical (kg)		
RCS2-SA5C-①-20-20-②-③-④-⑤	20	20	2	0.5	10.7	50~500 (Every 50mm)
RCS2-SA5C-①-20-12-②-③-④-⑤		12	4	1	16.7	
RCS2-SA5C-①-20-6-②-③-④-⑤		6	8	2	33.3	
RCS2-SA5C-①-20-3-②-③-④-⑤		3	12	4	65.7	

Legend: ① Encoder type ② Stroke ③ Applicable controller ④ Cable length ⑤ Options

Stroke and Maximum Speed

Stroke / Lead	50~450 (Every 50mm)	500 (mm)
	20	1,300 <800>
12	800	760
6	400	380
3	200	190

*Values in brackets < > are for vertical use. (Unit: mm/s)

① Encoder Type / ② Stroke

Stroke (mm)	Standard price	
	Encoder type	Battery-less absolute
50	-	WA
100	-	-
150	-	-
200	-	-
250	-	-
300	-	-
350	-	-
400	-	-
450	-	-
500	-	-

④ Cable Length

Type	Cable code	Standard price
Standard type	P (1m)	-
	S (3m)	-
	M (5m)	-
Special length	X06 (6m) ~ X10 (10m)	-
	X11 (11m) ~ X15 (15m)	-
	X16 (16m) ~ X20 (20m)	-
Robot cable	R01 (1m) ~ R03 (3m)	-
	R04 (4m) ~ R05 (5m)	-
	R06 (6m) ~ R10 (10m)	-
	R11 (11m) ~ R15 (15m)	-
	R16 (16m) ~ R20 (20m)	-

*Please refer to P. 84 for maintenance cables.

⑤ Options

Name	Option code	Reference page	Standard price
Brake	B	Please refer to our website for the details of the options.	-
CE marking	CE		-
Foot bracket	FT		-
High acceleration/deceleration	HA		-
Home check sensor	HS		-
Non-motor end specification	NM		-
Slider roller specification	SR		-

* High acceleration/deceleration option and slider roller option cannot be combined together.
* High acceleration/deceleration option cannot be chosen for lead 3.

Actuator Specifications

Item	Description
Drive system	Ball screw Ø10mm, rolled C10
Positioning repeatability	±0.02mm
Lost motion	0.1mm or less
Base	Material: Aluminum with white alumite treatment
Static allowable moment	Ma: 18.6N·m, Mb: 26.6N·m, Mc: 47.5N·m
Dynamic allowable moment (*)	Ma: 5.81N·m, Mb: 8.30N·m, Mc: 14.8N·m
Ambient operating temperature, humidity	0 to 40°C, 85% RH or less (Non-condensing)

*Reference for overhang load length/Ma: 150mm or less, Mb, Mc: 150mm or less
(*) Assumes a standard rated life of 5,000km. The operational life will vary depending on operation and installation conditions.
Please refer to our website for more information regarding the service life of the products, directions of the allowable moment, and overhang load length.

Dimensions

CAD drawings can be downloaded from our website, www.intelligentactuator.com



- *1 Connects the motor-encoder cable. Please refer to P. 84 for the details of the cables.
- *2 When the slider is returning to its home position, please be careful of interference from surrounding objects, as it will travel until it reaches the ME.
- ME: Mechanical end SE: Stroke end
- *3 Reference position used when calculating the Ma moment.

- *4 When the actuator is mounted only using the mounting holes on the top of the base, the base can be distorted, which could cause sliding error or abnormal noise. When using the mounting holes on the top of the base, please keep the stroke length less than 300mm.

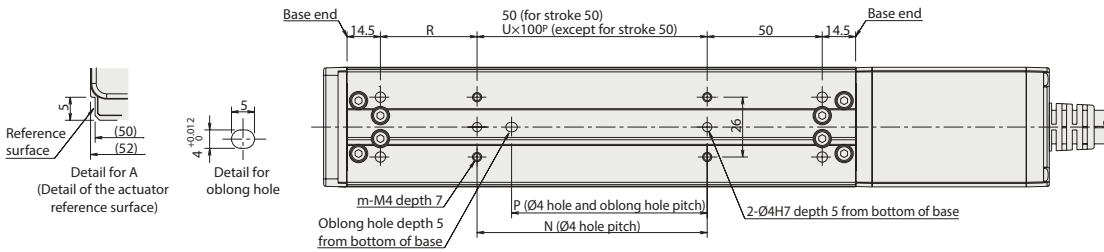
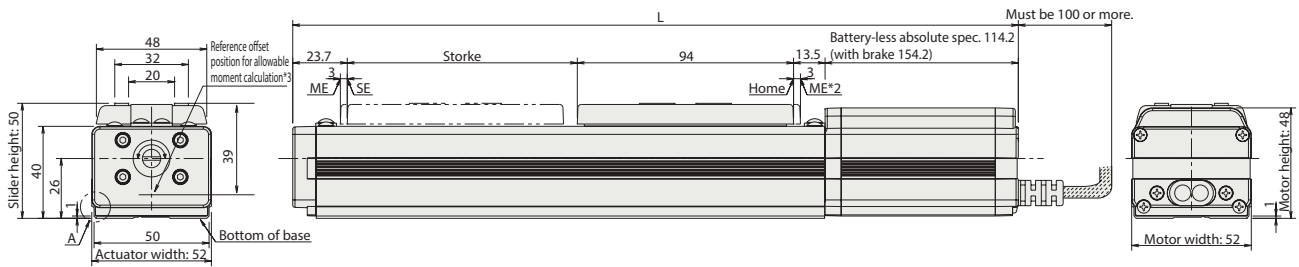
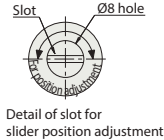
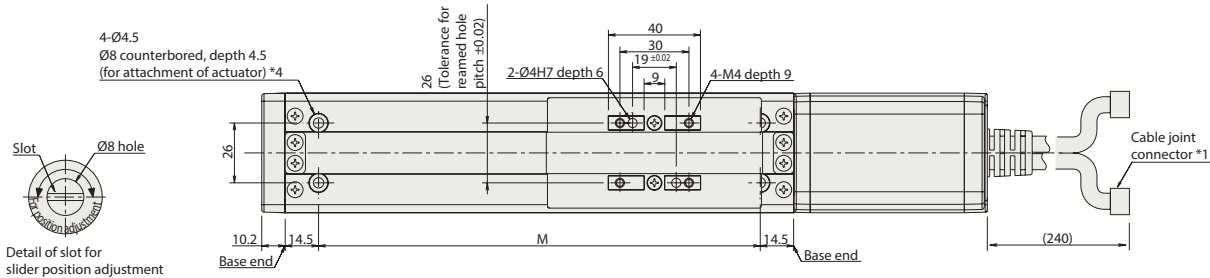

■ Dimensions and Mass by Stroke *Brake equipped types are 0.3kg heavier.

Stroke	50	100	150	200	250	300	350	400	450	500	
L	Battery-less absolute	295.4	345.4	395.4	445.4	495.4	545.4	595.4	645.4	695.4	745.4
	With brake	335.4	385.4	435.4	485.4	535.4	585.4	635.4	685.4	735.4	785.4
M	142	192	242	292	342	392	442	492	542	592	
N	50	100	100	200	200	300	300	400	400	500	
P	35	85	85	185	185	285	285	385	385	485	
R	42	42	92	42	92	42	92	42	92	42	
U	-	1	1	2	2	3	3	4	4	5	
m	4	4	4	6	6	8	8	10	10	12	
Mass (kg)	1.3	1.4	1.5	1.6	1.7	1.8	1.9	2	2.1	2.2	

RCS2-SA6C

ROBO Cylinder, Slider Type, Actuator Width 58mm, 200V Servo Motor, Coupled Motor Specification

Model Specification Items	RCS2	SA6C	<input type="checkbox"/>	30	<input type="checkbox"/>	<input type="checkbox"/>	<input type="checkbox"/>	<input type="checkbox"/>	<input type="checkbox"/>
	Series	Type	Encoder type	Motor type	Lead	Stroke	Applicable controller	Cable length	Options
			WA: Battery-less absolute	30: Servo motor 30W	20: 20mm 12: 12mm 6: 6mm 3: 3mm	50: 50mm 600: 600mm (Can be set in 50mm increments)	T2: SCON-CB	N: No cable P: 1m S: 3m M: 5m X <input type="checkbox"/> : Specified length R <input type="checkbox"/> : Robot cable	Please refer to the options table below.

*Controller is not included.



* CE marking is an option.

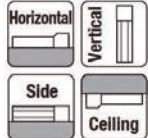

* Depending on the model, there may be some limitations to using the vertical, side, and ceiling mount positions. Please contact for more information regarding mounting positions.



* This product is equipped with a slot for slider position adjustment (refer to the dimensional drawing on the right page) shown as A in the figure above.

High Accel./Decel. Option
(Excludes lead 3)

- POINT**
Note on selection
- When the stroke is increased, the maximum speed will drop to prevent reaching a critical rotational speed of the ball screw. Please confirm the maximum speed for the desired stroke in the actuator specifications table below.
 - The payload assumes operation at an acceleration of 0.3G (0.2G for lead 3) for standard specification, and 1G for high accel./decel. specification (excludes lead 3). (The values shown in the table below are the upper limit for the maximum payload even if acceleration/deceleration is decreased.)
 - Please refer to our website for more information about push-motion operation.

Actuator Specifications

Lead and Payload

Model number	Motor (W)	Lead (mm)	Maximum payload		Rated thrust (N)	Stroke (mm)
			Horizontal (kg)	Vertical (kg)		
RCS2-SA6C-①-30-20-②-③-④-⑤	30	20	3	0.5	15.8	50~600 (Every 50mm)
RCS2-SA6C-①-30-12-②-③-④-⑤		12	6	1.5	24.2	
RCS2-SA6C-①-30-6-②-③-④-⑤		6	12	3	48.4	
RCS2-SA6C-①-30-3-②-③-④-⑤		3	18	6	96.8	

Legend: ① Encoder type ② Stroke ③ Applicable controller ④ Cable length ⑤ Options

Stroke and Maximum Speed

Stroke / Lead	50~450 (Every 50mm)	500 (mm)	550 (mm)	600 (mm)
	20	1,300 <800>	1,160 <800>	990 <800>
12	800	760	640	540
6	400	380	320	270
3	200	190	160	135

*Values in brackets <> are for vertical use. (Unit: mm/s)

① Encoder Type / ② Stroke

Stroke (mm)	Standard price	
	Encoder type	Battery-less absolute
	WA	
50	-	-
100	-	-
150	-	-
200	-	-
250	-	-
300	-	-
350	-	-
400	-	-
450	-	-
500	-	-
550	-	-
600	-	-

⑤ Options

Name	Option code	Reference page	Standard price
Brake	B	Please refer to our website for the details of the options.	-
CE marking	CE		-
Foot bracket	FT		-
High acceleration/deceleration	HA		-
Home check sensor	HS		-
Non-motor end specification	NM		-
Slider roller specification	SR		-

* High acceleration/deceleration option and slider roller option cannot be combined together.
* High acceleration/deceleration option cannot be chosen for lead 3.

④ Cable Length

Type	Cable code	Standard price
Standard type	P (1m)	-
	S (3m)	-
	M (5m)	-
Special length	X06 (6m) ~ X10 (10m)	-
	X11 (11m) ~ X15 (15m)	-
	X16 (16m) ~ X20 (20m)	-
Robot cable	R01 (1m) ~ R03 (3m)	-
	R04 (4m) ~ R05 (5m)	-
	R06 (6m) ~ R10 (10m)	-
	R11 (11m) ~ R15 (15m)	-
	R16 (16m) ~ R20 (20m)	-

*Please refer to P. 84 for maintenance cables.

Actuator Specifications

Item	Description
Drive system	Ball screw Ø10mm, rolled C10
Positioning repeatability	±0.02mm
Lost motion	0.1mm or less
Base	Material: Aluminum with white alumite treatment
Static allowable moment	Ma: 38.3N·m, Mb: 54.7N·m, Mc: 81.0N·m
Dynamic allowable moment (*)	Ma: 11.6N·m, Mb: 16.6N·m, Mc: 24.6N·m
Ambient operating temperature, humidity	0 to 40°C, 85% RH or less (Non-condensing)

*Reference for overhang load length/Ma: 220mm or less, Mb, Mc: 220mm or less
(*) Assumes a standard rated life of 5,000km. The operational life will vary depending on operation and installation conditions.
Please refer to our website for more information regarding the service life of the products, directions of the allowable moment, and overhang load length.

Dimensions

CAD drawings can be downloaded from our website, www.intelligentactuator.com



- *1 Connects the motor-encoder cable. Please refer to P.84 for the details of the cables.
- *2 When the slider is returning to its home position, please be careful of interference from surrounding objects, as it will travel until it reaches the ME.
- ME: Mechanical end SE: Stroke end
- *3 Reference position used when calculating the Ma moment.

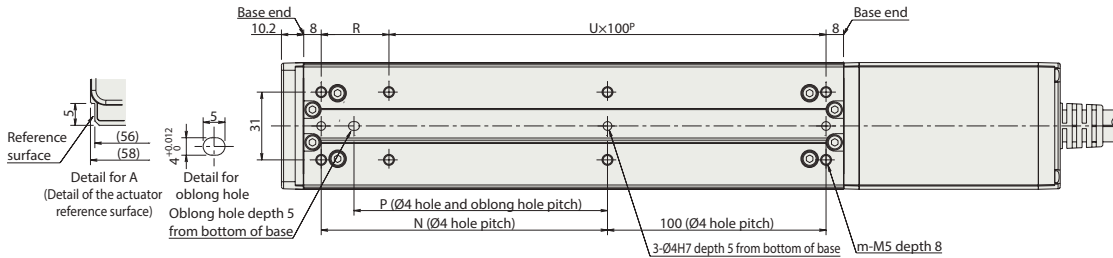
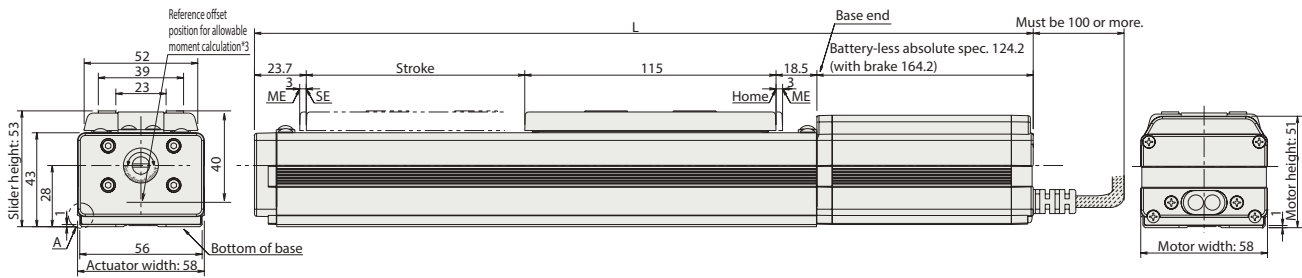
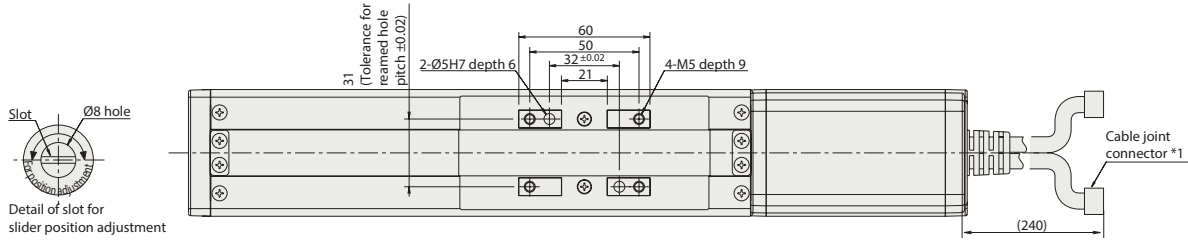

■ Dimensions and Mass by Stroke *Brake equipped types are 0.3kg heavier.

L	Stroke		50	100	150	200	250	300	350	400	450	500	550	600
	Battery-less absolute	Without brake	With brake	331.4	381.4	431.4	481.4	531.4	581.4	631.4	681.4	731.4	781.4	831.4
	N		81	131	181	231	281	331	381	431	481	531	581	631
	P		66	116	166	216	266	316	366	416	466	516	566	616
	R		81	31	81	31	81	31	81	31	81	31	81	31
	U		1	2	2	3	3	4	4	5	5	6	6	7
	m		6	8	8	10	10	12	12	14	14	16	16	18
	Mass (kg)		1.4	1.6	1.8	2	2.2	2.4	2.6	2.8	3	3.2	3.4	3.6

RCS2-SA7C

ROBO Cylinder, Slider Type, Actuator Width 73mm, 200V Servo Motor, Coupled Motor Specification

Model Specification Items	RCS2	SA7C	<input type="checkbox"/>	60	<input type="checkbox"/>	<input type="checkbox"/>	<input type="checkbox"/>	<input type="checkbox"/>	<input type="checkbox"/>
	Series	Type	Encoder type	Motor type	Lead	Stroke	Applicable controller	Cable length	Options
			WA: Battery-less absolute	60: Servo motor 60W	24: 24mm 16: 16mm 8: 8mm 4: 4mm	50: 50mm ↓ 800: 800mm (Can be set in 50mm increments)	T2: SCON-CB	N: No cable P: 1m S: 3m M: 5m X <input type="checkbox"/> : Specified length R <input type="checkbox"/> : Robot cable	Please refer to the options table below.

*Controller is not included.



* CE marking is an option.

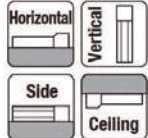

* Depending on the model, there may be some limitations to using the vertical, side, and ceiling mount positions. Please contact for more information regarding mounting positions.



High Accel./Decel. Option
(Excludes lead 4)

- POINT**
Note on selection
- When the stroke is increased, the maximum speed will drop to prevent reaching a critical rotational speed of the ball screw. Please confirm the maximum speed for the desired stroke in the actuator specifications table below.
 - The payload assumes operation at an acceleration of 0.3G (0.2G for lead 4) for standard specification, and 1G for high accel./decel. specification (0.8G for lead 8 and 24. Excludes lead 4). (The values shown in the table below are the upper limit for the maximum payload even if acceleration/deceleration is decreased.)
 - Please refer to our website for more information about push-motion operation.

Actuator Specifications

Lead and Payload

Model number	Motor (W)	Lead (mm)	Maximum payload		Rated thrust (N)	Stroke (mm)
			Horizontal (kg)	Vertical (kg)		
RCS2-SA7C-①-60-24-②-③-④-⑤	60	24	8	1.4	42.4	50~800 (Every 50mm)
RCS2-SA7C-①-60-16-②-③-④-⑤		16	12	3	63.8	
RCS2-SA7C-①-60-8-②-③-④-⑤		8	25	6	127.5	
RCS2-SA7C-①-60-4-②-③-④-⑤		4	40	12	255.0	

Legend: ① Encoder type ② Stroke ③ Applicable controller ④ Cable length ⑤ Options

Stroke and Maximum Speed

Stroke / Lead	50~600 (Every 50mm)	~700 (mm)	~800 (mm)
	24	1,200	960
16	800	640	480
8	400	320	240
4	200	160	120

(Unit: mm/s)

① Encoder Type / ② Stroke

Stroke (mm)	Standard price	
	Encoder type	Battery-less absolute
	WA	
50/100	-	-
150/200	-	-
250/300	-	-
350/400	-	-
450/500	-	-
550/600	-	-
650/700	-	-
750/800	-	-

④ Cable Length

Type	Cable code	Standard price
Standard type	P (1m)	-
	S (3m)	-
	M (5m)	-
Special length	X06 (6m) ~X10 (10m)	-
	X11 (11m) ~X15 (15m)	-
	X16 (16m) ~X20 (20m)	-
Robot cable	R01 (1m) ~R03 (3m)	-
	R04 (4m) ~R05 (5m)	-
	R06 (6m) ~R10 (10m)	-
	R11 (11m) ~R15 (15m)	-
	R16 (16m) ~R20 (20m)	-

*Please refer to P. 84 for maintenance cables.

⑤ Options

Name	Option code	Reference page	Standard price
Brake (Cable exit to end)	BE	Please refer to our website for the details of the options.	-
Brake (Cable exit to left side)	BL		-
Brake (Cable exit to right side)	BR		-
CE marking	CE		-
High acceleration/deceleration	HA		-
Non-motor end specification	NM		-
Slider roller specification	SR		-

* High acceleration/deceleration option and slider roller option cannot be combined together.
* High acceleration/deceleration option cannot be chosen for lead 4.

Actuator Specifications

Item	Description
Drive system	Ball screw Ø12mm, rolled C10
Positioning repeatability	±0.02mm
Lost motion	0.1mm or less
Base	Material: Aluminum with white alumite treatment
Static allowable moment	Ma: 50.4N·m, Mb: 71.9N·m, Mc: 138.0N·m
Dynamic allowable moment (*)	Ma: 20.7N·m, Mb: 29.6N·m, Mc: 56.7N·m
Ambient operating temperature, humidity	0 to 40°C, 85% RH or less (Non-condensing)

*Reference for overhang load length/Ma: 230mm or less, Mb, Mc: 230mm or less
(*) Assumes a standard rated life of 5,000km. The operational life will vary depending on operation and installation conditions.
Please refer to our website for more information regarding the service life of the products, directions of the allowable moment, and overhang load length.

Dimensions

CAD drawings can be downloaded from our website, www.intelligentactuator.com



- *1 Connects the motor-encoder cable. Please refer to P.84 for the details of the cables.
- *2 When the slider is returning to its home position, please be careful of interference from surrounding objects, as it will travel until it reaches the ME.
- ME: Mechanical end SE: Stroke end
- *3 Reference position used when calculating the Ma moment.

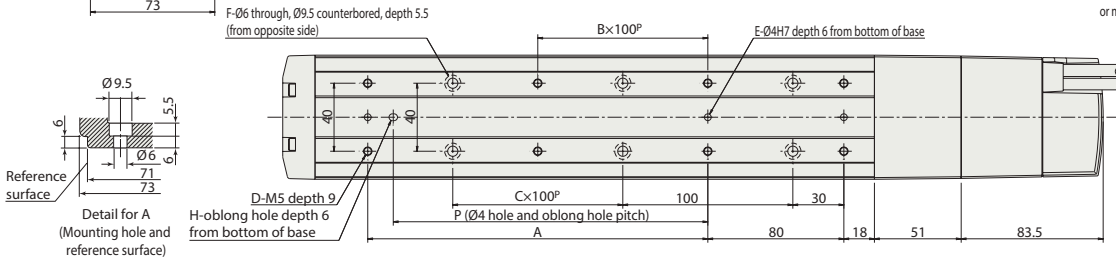
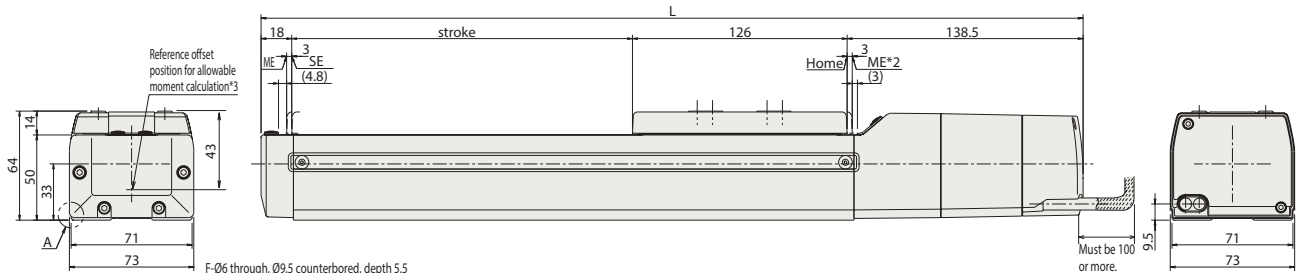
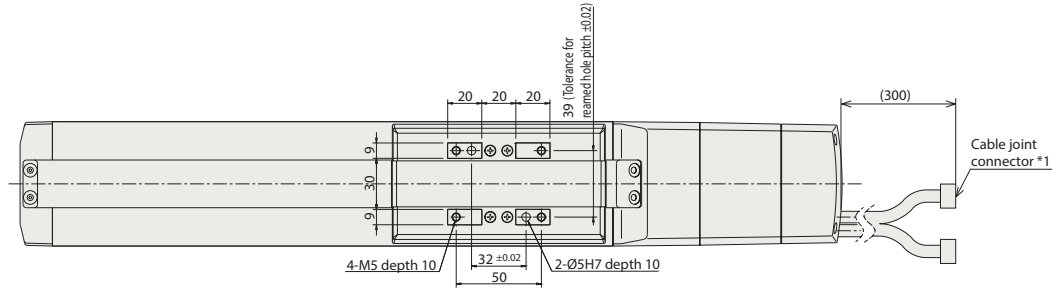

Dimensions for the brake part

*The total length for brake-equipped type is 43mm (56.3mm when cable exits from rear end) the weight increases by 0.6kg.

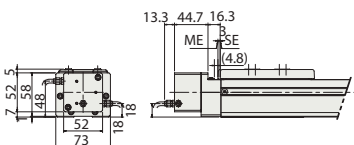
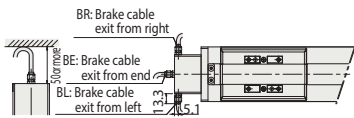
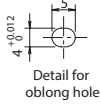

Dimensions and Mass by Stroke

Stroke	50	100	150	200	250	300	350	400	450	500	550	600	650	700	750	800
L	332.5	382.5	432.5	482.5	532.5	582.5	632.5	682.5	732.5	782.5	832.5	882.5	932.5	982.5	1,032.5	1,082.5
A	0	100	100	200	200	300	300	400	400	500	500	600	600	700	700	800
B	0	0	0	1	1	2	2	3	3	4	4	5	5	6	6	7
C	0	0	1	1	2	2	3	3	4	4	5	5	6	6	7	7
D	4	6	6	8	8	10	10	12	12	14	14	16	16	18	18	20
E	2	3	3	3	3	3	3	3	3	3	3	3	3	3	3	3
F	4	4	6	6	8	8	10	10	12	12	14	14	16	16	18	18
H	0	1	1	1	1	1	1	1	1	1	1	1	1	1	1	1
P	0	85	85	185	185	285	285	385	385	485	485	585	585	685	685	785
Mass (kg)	2.4	2.6	2.8	3.0	3.3	3.5	3.7	3.9	4.2	4.4	4.6	4.8	5.1	5.3	5.5	5.7

RCS2-SA4R

ROBO Cylinder, Slider Type, Actuator Width 40mm, 200V Servo Motor, Side-mounted Motor Specification

Model Specification Items	RCS2	SA4R	<input type="checkbox"/>	20	<input type="checkbox"/>	<input type="checkbox"/>	<input type="checkbox"/>	<input type="checkbox"/>	<input type="checkbox"/>
	Series	Type	Encoder type	Motor type	Lead	Stroke	Applicable controller	Cable length	Options
			WA: Battery-less absolute	20: Servo motor 20W	10: 10mm 5: 5mm 2.5: 2.5mm	50: 50mm 400: 400mm (Can be set in 50mm increments)	T2: SCON-CB	N: No cable P: 1m S: 3m M: 5m X <input type="checkbox"/> : Specified length R <input type="checkbox"/> : Robot cable	Please refer to the options table below. * Please specify which side the motor is to be mounted (ML/MR)

*Controller is not included.



* CE marking is an option.

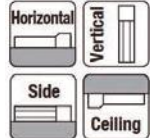

* Depending on the model, there may be some limitations to using the vertical, side, and ceiling mount positions. Please contact for more information regarding mounting positions.

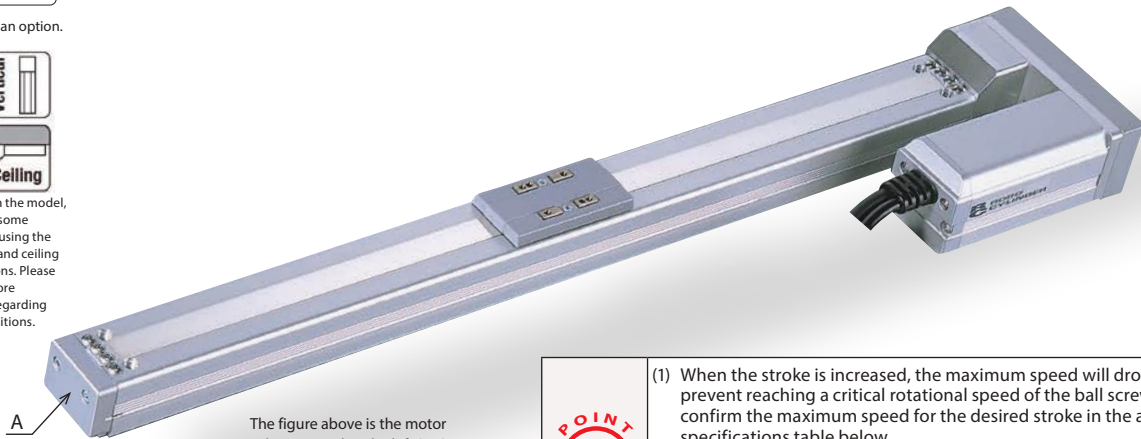

The figure above is the motor side-mounted to the left (ML).

* This product is equipped with a slot for slider position adjustment (refer to the dimensional drawing on the right page) shown as A in the figure above.

POINT
Note on selection

- When the stroke is increased, the maximum speed will drop to prevent reaching a critical rotational speed of the ball screw. Please confirm the maximum speed for the desired stroke in the actuator specifications table below.
- The payload assumes operation at an acceleration of 0.3G (0.2G for lead 2.5). This is the upper limit of the acceleration.
- Please refer to our website for more information about push-motion operation.

Actuator Specifications								
Lead and Payload				Stroke and Maximum Speed				
Model number	Motor (W)	Lead (mm)	Maximum payload		Rated thrust (N)	Stroke (mm)	Stroke	
			Horizontal (kg)	Vertical (kg)			Lead	50~400 (Every 50mm)
RCS2-SA4R-①-20-10-②-③-④-⑤	20	10	4	1	19.6	50~400 (Every 50mm)	10	665
RCS2-SA4R-①-20-5-②-③-④-⑤		5	6	2.5	39.2		5	330
RCS2-SA4R-①-20-2.5-②-③-④-⑤		2.5	8	4.5	78.4		2.5	165

Legend: ① Encoder type ② Stroke ③ Applicable controller ④ Cable length ⑤ Options (Unit: mm/s)

① Encoder Type / ② Stroke	
Stroke (mm)	Standard price
	Encoder type
	Battery-less absolute
	WA
50	-
100	-
150	-
200	-
250	-
300	-
350	-
400	-

④ Cable Length		
Type	Cable code	Standard price
Standard type	P (1m)	-
	S (3m)	-
	M (5m)	-
Special length	X06 (6m) ~ X10 (10m)	-
	X11 (11m) ~ X15 (15m)	-
	X16 (16m) ~ X20 (20m)	-
Robot cable	R01 (1m) ~ R03 (3m)	-
	R04 (4m) ~ R05 (5m)	-
	R06 (6m) ~ R10 (10m)	-
	R11 (11m) ~ R15 (15m)	-
	R16 (16m) ~ R20 (20m)	-
	R21 (21m) ~ R25 (25m)	-

*Please refer to P. 84 for maintenance cables.

⑤ Options			
Name	Option code	Reference page	Standard price
Brake	B	Please refer to our website for the details of the options.	-
CE marking	CE		-
Home check sensor	HS		-
Non-motor end specification	NM		-
Motor side-mounted to the left (Standard)	ML		-
Motor side-mounted to the right	MR		-
Slider roller specification	SR		-
Slider spacer	SS		-

Actuator Specifications	
Item	Description
Drive system	Ball screw Ø8mm, rolled C10
Positioning repeatability	±0.02mm
Lost motion	0.1mm or less
Base	Material: Aluminum with white alumite treatment
Static allowable moment	Ma: 6.90N·m, Mb: 9.90N·m, Mc: 17.0N·m
Dynamic allowable moment (*)	Ma: 3.29N·m, Mb: 4.71N·m, Mc: 8.07N·m
Ambient operating temperature, humidity	0 to 40°C, 85% RH or less (Non-condensing)

*Reference for overhang load length/Ma: 120mm or less, Mb, Mc: 120mm or less
 (*) Assumes a standard rated life of 5,000km. The operational life will vary depending on operation and installation conditions.
 Please refer to our website for more information regarding the service life of the products, directions of the allowable moment, and overhang load length.

Dimensions

CAD drawings can be downloaded from our website, www.intelligentactuator.com

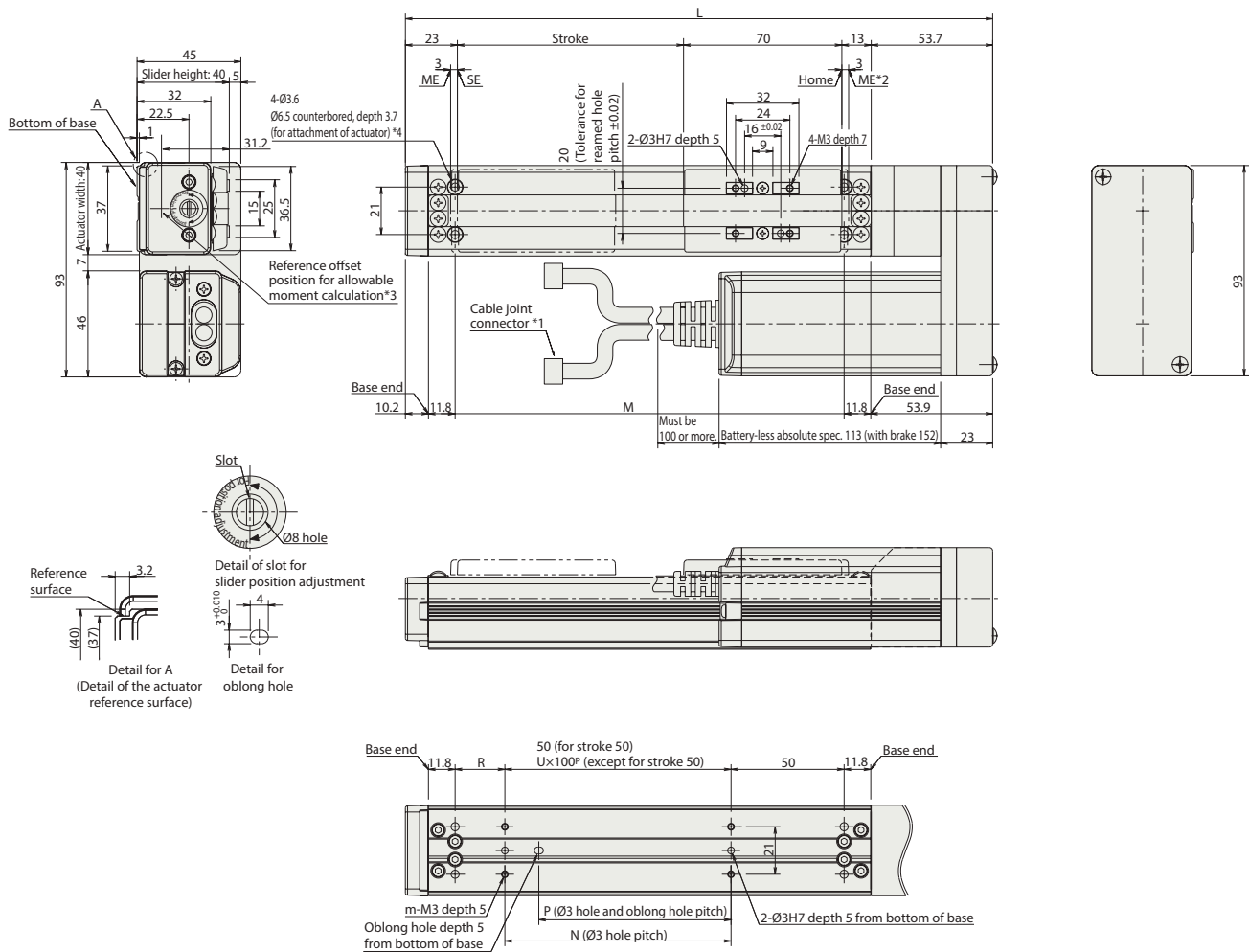

- *1 Connects the motor-encoder cable. Please refer to P.84 for the details of the cables.
- *2 When the slider is returning to its home position, please be careful of interference from surrounding objects, as it will travel until it reaches the ME.
ME: Mechanical end SE: Stroke end
- *3 Reference position used when calculating the Ma moment.
- *4 When the actuator is mounted only using the mounting holes on the top of the base, the base can be distorted, which could cause sliding error or abnormal noise. When using the mounting holes on the top of the base, please keep the stroke length less than 200mm.

■Dimensions and Mass by Stroke *Brake equipped types are 0.3kg heavier.

Stroke	50	100	150	200	250	300	350	400
L	209.7	259.7	309.7	359.7	409.7	459.7	509.7	559.7
M	122	172	222	272	322	372	422	472
N	50	100	100	200	200	300	300	400
P	35	85	85	185	185	285	285	385
R	22	22	72	22	72	22	72	22
U	-	1	1	2	2	3	3	4
m	4	4	4	6	6	8	8	10
Mass (kg)	0.8	0.9	1.0	1.1	1.2	1.3	1.4	1.5

RCS2-SA5R

ROBO Cylinder, Slider Type, Actuator Width 52mm, 200V Servo Motor, Side-mounted Motor Specification

Model Specification Items	RCS2	SA5R	<input type="checkbox"/>	20	<input type="checkbox"/>	<input type="checkbox"/>	<input type="checkbox"/>	<input type="checkbox"/>	<input type="checkbox"/>
	Series	Type	Encoder type	Motor type	Lead	Stroke	Applicable controller	Cable length	Options
			WA: Battery-less absolute	20: Servo motor 20W	12: 12mm 6: 6mm 3: 3mm	50: 50mm 1 500: 500mm (Can be set in 50mm increments)	T2: SCON-CB	N: No cable P: 1m S: 3m M: 5m X <input type="checkbox"/> : Specified length R <input type="checkbox"/> : Robot cable	Please refer to the options table below. * Please specify which side the motor is to be mounted (ML/MR)

*Controller is not included.



* CE marking is an option.

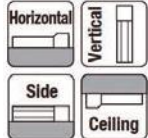

* Depending on the model, there may be some limitations to using the vertical, side, and ceiling mount positions. Please contact for more information regarding mounting positions.



The figure above is the motor side-mounted to the left (ML).

* This product is equipped with a slot for slider position adjustment (refer to the dimensional drawing on the right page) shown as A in the figure above.

- POINT**
Note on selection

 - (1) When the stroke is increased, the maximum speed will drop to prevent reaching a critical rotational speed of the ball screw. Please confirm the maximum speed for the desired stroke in the actuator specifications table below.
 - (2) The payload assumes operation at an acceleration of 0.3G (0.2G for lead 3). This is the upper limit of the acceleration.
 - (3) Please refer to our website for more information about push-motion operation.

Actuator Specifications

Lead and Payload

Model number	Motor (W)	Lead (mm)	Maximum payload		Rated thrust (N)	Stroke (mm)
			Horizontal (kg)	Vertical (kg)		
RCS2-SA5R-①-20-12-②-③-④-⑤	20	12	4	1	16.7	50~500 (Every 50mm)
RCS2-SA5R-①-20-6-②-③-④-⑤		6	8	2	33.3	
RCS2-SA5R-①-20-3-②-③-④-⑤		3	12	4	65.7	

Legend: ① Encoder type ② Stroke ③ Applicable controller ④ Cable length ⑤ Options

Stroke and Maximum Speed

Stroke / Lead	50~450 (Every 50mm)	500 (mm)
	12	800
6	400	380
3	200	190

(Unit: mm/s)

① Encoder Type / ② Stroke

Stroke (mm)	Standard price
	Encoder type
	Battery-less absolute
	WA
50	-
100	-
150	-
200	-
250	-
300	-
350	-
400	-
450	-
500	-

④ Cable Length

Type	Cable code	Standard price
Standard type	P (1m)	-
	S (3m)	-
	M (5m)	-
Special length	X06 (6m) ~X10 (10m)	-
	X11 (11m) ~X15 (15m)	-
	X16 (16m) ~X20 (20m)	-
Robot cable	R01 (1m) ~R03 (3m)	-
	R04 (4m) ~R05 (5m)	-
	R06 (6m) ~R10 (10m)	-
	R11 (11m) ~R15 (15m)	-
	R16 (16m) ~R20 (20m)	-

*Please refer to P. 84 for maintenance cables.

⑤ Options

Name	Option code	Reference page	Standard price
Brake	B	Please refer to our website for the details of the options.	-
CE marking	CE		-
Home check sensor	HS		-
Non-motor end specification	NM		-
Motor side-mounted to the left (Standard)	ML		-
Motor side-mounted to the right	MR		-
Slider roller specification	SR		-

Actuator Specifications

Item	Description
Drive system	Ball screw Ø10mm, rolled C10
Positioning repeatability	±0.02mm
Lost motion	0.1mm or less
Base	Material: Aluminum with white alumite treatment
Static allowable moment	Ma: 18.6N·m, Mb: 26.6N·m, Mc: 47.5N·m
Dynamic allowable moment (*)	Ma: 5.81N·m, Mb: 8.30N·m, Mc: 14.8N·m
Ambient operating temperature, humidity	0 to 40°C, 85% RH or less (Non-condensing)

*Reference for overhang load length/Ma: 150mm or less, Mb, Mc: 150mm or less

(*) Assumes a standard rated life of 5,000km. The operational life will vary depending on operation and installation conditions.

Please refer to our website for more information regarding the service life of the products, directions of the allowable moment, and overhang load length.

Dimensions

CAD drawings can be downloaded from our website, www.intelligentactuator.com

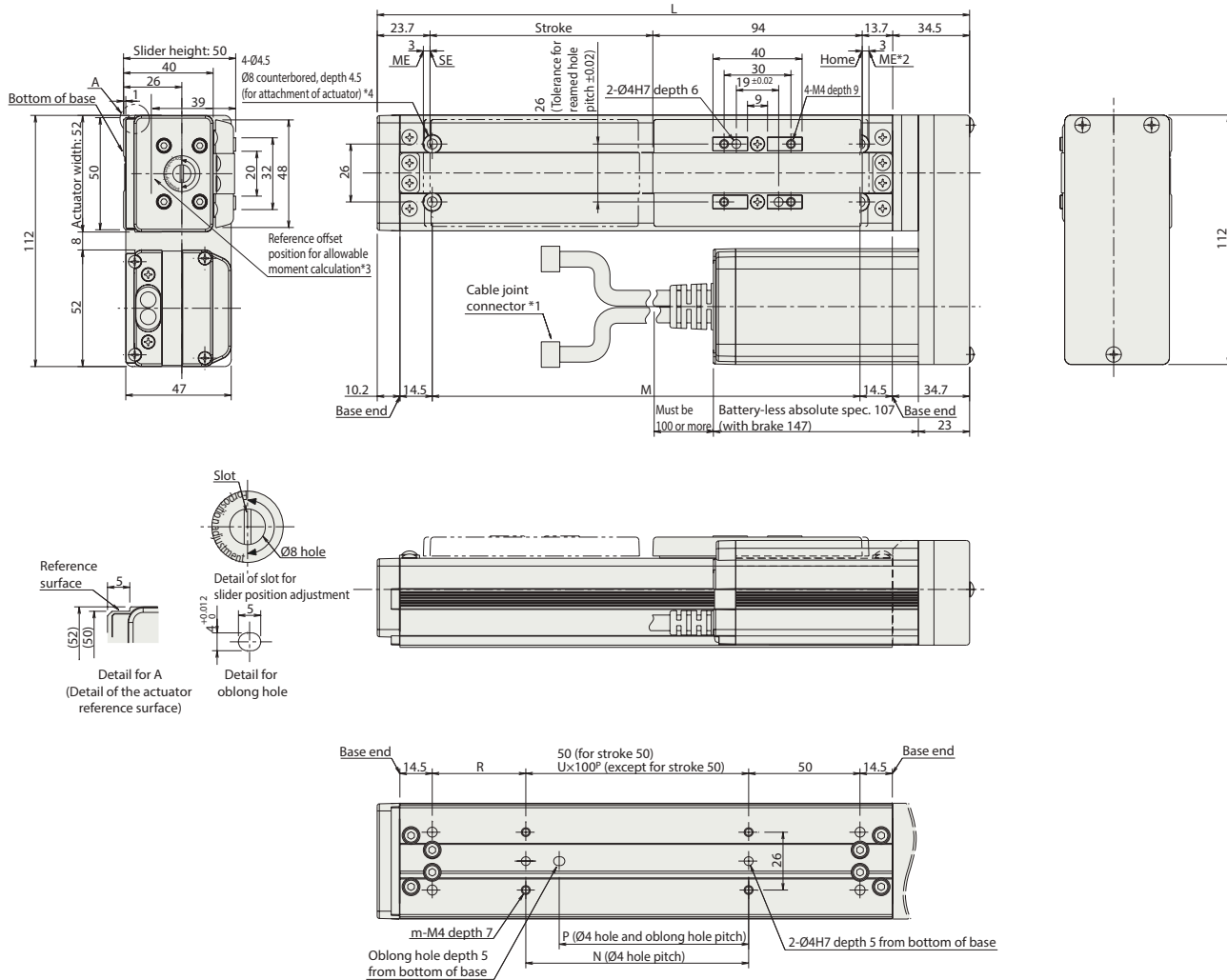

- *1 Connects the motor-encoder cable. Please refer to P.84 for the details of the cables.
- *2 When the slider is returning to its home position, please be careful of interference from surrounding objects, as it will travel until it reaches the ME.
ME: Mechanical end SE: Stroke end
- *3 Reference position used when calculating the Ma moment.
- *4 When the actuator is mounted only using the mounting holes on the top of the base, the base can be distorted, which could cause sliding error or abnormal noise. When using the mounting holes on the top of the base, please keep the stroke length less than 300mm.

■ Dimensions and Mass by Stroke *Brake equipped types are 0.3kg heavier.

Stroke	50	100	150	200	250	300	350	400	450	500
L	215.9	265.9	315.9	365.9	415.9	465.9	515.9	565.9	615.9	665.9
M	142	192	242	292	342	392	442	492	542	592
N	50	100	100	200	200	300	300	400	400	500
P	35	85	85	185	185	285	285	385	385	485
R	42	42	92	42	92	42	92	42	92	42
U	-	1	1	2	2	3	3	4	4	5
m	4	4	4	6	6	8	8	10	10	12
Mass (kg)	1.5	1.6	1.7	1.8	1.9	2.0	2.1	2.2	2.3	2.4

RCS2-SA6R

ROBO Cylinder, Slider Type, Actuator Width 58mm, 200V Servo Motor, Side-mounted Motor Specification

Model Specification Items	RCS2	SA6R	<input type="checkbox"/>	30	<input type="checkbox"/>	<input type="checkbox"/>	<input type="checkbox"/>	<input type="checkbox"/>	<input type="checkbox"/>
	Series	Type	Encoder type	Motor type	Lead	Stroke	Applicable controller	Cable length	Options
			WA: Battery-less absolute	30: Servo motor 30W	12: 12mm 6: 6mm 3: 3mm	50: 50mm 600: 600mm (Can be set in 50mm increments)	T2: SCON-CB	N: No cable P: 1m S: 3m M: 5m X <input type="checkbox"/> : Specified length R <input type="checkbox"/> : Robot cable	Please refer to the options table below. * Please specify which side the motor is to be mounted (ML/MR)

*Controller is not included.



* CE marking is an option.

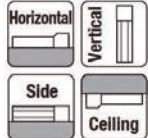

* Depending on the model, there may be some limitations to using the vertical, side, and ceiling mount positions. Please contact for more information regarding mounting positions.



The figure above is the motor side-mounted to the left (ML).

* This product is equipped with a slot for slider position adjustment (refer to the dimensional drawing on the right page) shown as A in the figure above.

POINT
Note on selection

- When the stroke is increased, the maximum speed will drop to prevent reaching a critical rotational speed of the ball screw. Please confirm the maximum speed for the desired stroke in the actuator specifications table below.
- The payload assumes operation at an acceleration of 0.3G (0.2G for lead 3). This is the upper limit of the acceleration.
- Please refer to our website for more information about push-motion operation.

Actuator Specifications											
Lead and Payload				Stroke and Maximum Speed							
Model number	Motor (W)	Lead (mm)	Maximum payload		Rated thrust (N)	Stroke (mm)	Stroke				
			Horizontal (kg)	Vertical (kg)			Lead	50~450 (Every 50mm)	500 (mm)	550 (mm)	600 (mm)
RCS2-SA6R-①-30-12-②-③-④-⑤	30	12	6	1.5	24.2	50~600 (Every 50mm)	12	800	760	640	540
RCS2-SA6R-①-30-6-②-③-④-⑤		6	12	3	48.4		6	400	380	320	270
RCS2-SA6R-①-30-3-②-③-④-⑤		3	18	6	96.8		3	200	190	160	135

Legend: ① Encoder type ② Stroke ③ Applicable controller ④ Cable length ⑤ Options (Unit: mm/s)

Stroke (mm)	Standard price	
	Encoder type	Battery-less absolute
	WA	
50	-	-
100	-	-
150	-	-
200	-	-
250	-	-
300	-	-
350	-	-
400	-	-
450	-	-
500	-	-
550	-	-
600	-	-

Type	Cable code	Standard price
Standard type	P (1m)	-
	S (3m)	-
	M (5m)	-
Special length	X06 (6m) ~ X10 (10m)	-
	X11 (11m) ~ X15 (15m)	-
	X16 (16m) ~ X20 (20m)	-
Robot cable	R01 (1m) ~ R03 (3m)	-
	R04 (4m) ~ R05 (5m)	-
	R06 (6m) ~ R10 (10m)	-
	R11 (11m) ~ R15 (15m)	-
	R16 (16m) ~ R20 (20m)	-

*Please refer to P. 84 for maintenance cables.

Name	Option code	Reference page	Standard price
Brake	B	-	-
CE marking	CE	-	-
Home check sensor	HS	Please refer to our website for the details of the options.	-
Non-motor end specification	NM		-
Motor side-mounted to the left (Standard)	ML		-
Motor side-mounted to the right	MR		-
Slider roller specification	SR	-	-

Item	Description
Drive system	Ball screw Ø10mm, rolled C10
Positioning repeatability	±0.02mm
Lost motion	0.1mm or less
Base	Material: Aluminum with white alumite treatment
Static allowable moment	Ma: 38.3N·m, Mb: 54.7N·m, Mc: 81.0N·m
Dynamic allowable moment (*)	Ma: 11.6N·m, Mb: 16.6N·m, Mc: 24.6N·m
Ambient operating temperature, humidity	0 to 40°C, 85% RH or less (Non-condensing)

*Reference for overhang load length/Ma: 220mm or less, Mb, Mc: 220mm or less
 (*) Assumes a standard rated life of 5,000km. The operational life will vary depending on operation and installation conditions.
 Please refer to our website for more information regarding the service life of the products, directions of the allowable moment, and overhang load length.

Dimensions

CAD drawings can be downloaded from our website, www.intelligentactuator.com

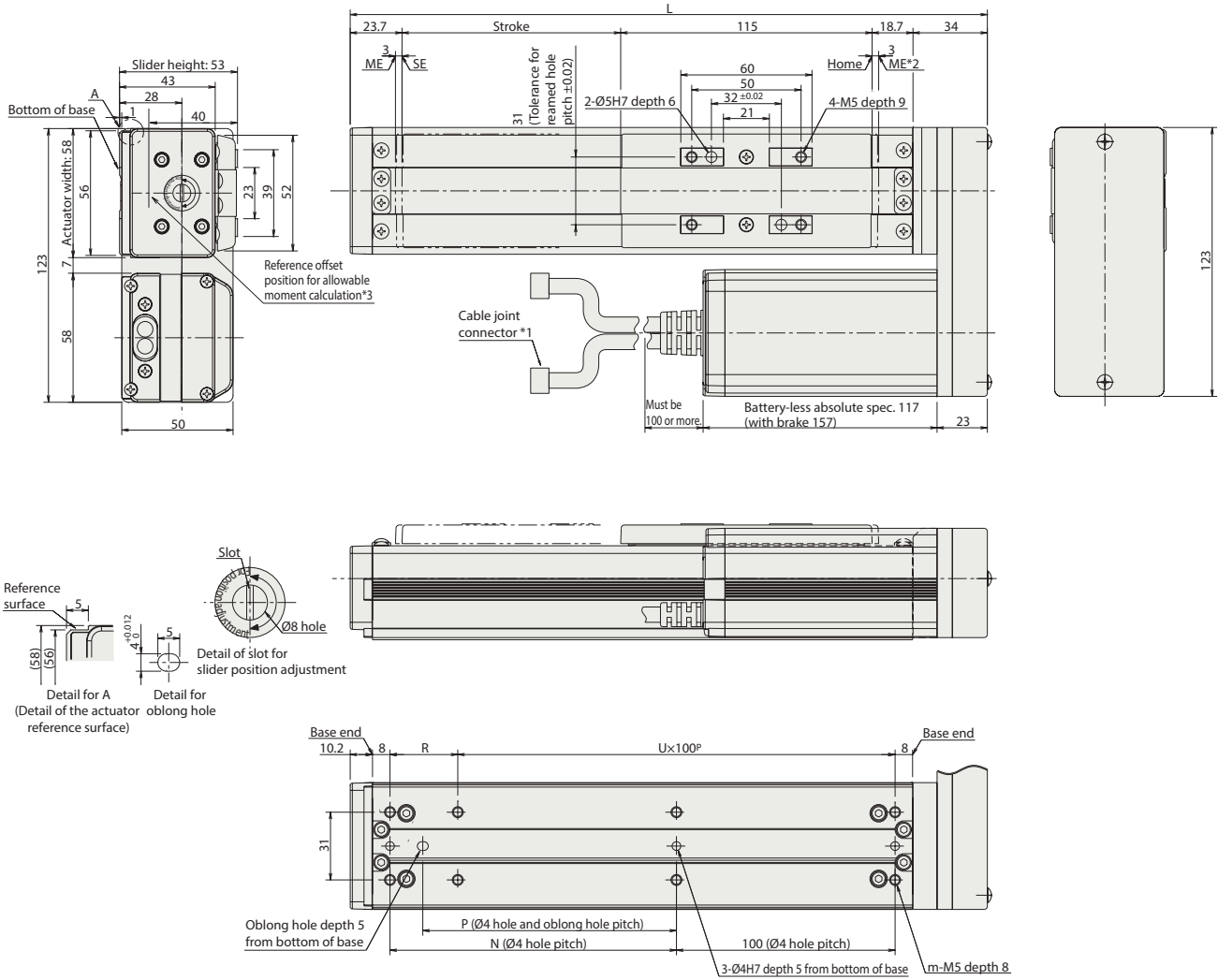

*1 Connects the motor-encoder cable. Please refer to P. 84 for the details of the cables.

*2 When the slider is returning to its home position, please be careful of interference from surrounding objects, as it will travel until it reaches the ME.

ME: Mechanical end SE: Stroke end

*3 Reference position used when calculating the Ma moment.

■Dimensions and Mass by Stroke *Brake equipped types are 0.3kg heavier.

Stroke	50	100	150	200	250	300	350	400	450	500	550	600
L	241.4	291.4	341.4	391.4	441.4	491.4	541.4	591.4	641.4	691.4	741.4	791.4
N	81	131	181	231	281	331	381	431	481	531	581	631
P	66	116	166	216	266	316	366	416	466	516	566	616
R	81	31	81	31	81	31	81	31	81	31	81	31
U	1	2	2	3	3	4	4	5	5	6	6	7
m	6	8	8	10	10	12	12	14	14	16	16	18
Mass (kg)	1.7	1.9	2.1	2.3	2.5	2.7	2.9	3.1	3.3	3.5	3.7	3.9

RCS2-SA7R

ROBO Cylinder, Slider Type, Actuator Width 73mm, 200V Servo Motor, Side-mounted Motor Specification

Model Specification Items	RCS2	SA7R	<input type="checkbox"/>	60	<input type="checkbox"/>	<input type="checkbox"/>	<input type="checkbox"/>	<input type="checkbox"/>	<input type="checkbox"/>
	Series	Type	Encoder type	Motor type	Lead	Stroke	Applicable controller	Cable length	Options
			WA: Battery-less absolute	60: Servo motor 60W	16: 16mm 8: 8mm 4: 4mm	50: 50mm ↓ 800: 800mm (Can be set in 50mm increments)	T2: SCON-CB	N: No cable P: 1m S: 3m M: 5m X <input type="checkbox"/> <input type="checkbox"/> : Specified length R <input type="checkbox"/> <input type="checkbox"/> : Robot cable	Please refer to the options table below. * Please specify which side the motor is to be mounted (ML/MR)

*Controller is not included.



* CE marking is an option.

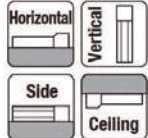

* Depending on the model, there may be some limitations to using the vertical, side, and ceiling mount positions. Please contact for more information regarding mounting positions.



The figure above is the motor side-mounted to the left (ML).

- POINT**
Note on selection
- When the stroke is increased, the maximum speed will drop to prevent reaching a critical rotational speed of the ball screw. Please confirm the maximum speed for the desired stroke in the actuator specifications table below.
 - The payload assumes operation at an acceleration of 0.3G (0.2G for lead 4). This is the upper limit of the acceleration.
 - Please refer to our website for more information about push-motion operation.

Actuator Specifications										
Lead and Payload				Stroke and Maximum Speed						
Model number	Motor (W)	Lead (mm)	Maximum payload		Rated thrust (N)	Stroke (mm)	Stroke / Lead	50~600 (Every 50mm)	~700 (mm)	~800 (mm)
			Horizontal (kg)	Vertical (kg)						
RCS2-SA7R-①-60-16-②-③-④-⑤	60	16	12	3	63.8	50~800 (Every 50mm)	16	800	640	480
RCS2-SA7R-①-60-8-②-③-④-⑤		8	25	6	127.5		8	400	320	240
RCS2-SA7R-①-60-4-②-③-④-⑤		4	40	12	255.0		4	200	160	120

Legend: ① Encoder type ② Stroke ③ Applicable controller ④ Cable length ⑤ Options (Unit: mm/s)

① Encoder Type / ② Stroke	
Stroke (mm)	Standard price
	Encoder type
	Battery-less absolute
	WA
50/100	-
150/200	-
250/300	-
350/400	-
450/500	-
550/600	-
650/700	-
750/800	-

④ Cable Length		
Type	Cable code	Standard price
Standard type	P (1m)	-
	S (3m)	-
	M (5m)	-
Special length	X06 (6m) ~ X10 (10m)	-
	X11 (11m) ~ X15 (15m)	-
	X16 (16m) ~ X20 (20m)	-
Robot cable	R01 (1m) ~ R03 (3m)	-
	R04 (4m) ~ R05 (5m)	-
	R06 (6m) ~ R10 (10m)	-
	R11 (11m) ~ R15 (15m)	-
	R16 (16m) ~ R20 (20m)	-

*Please refer to P. 84 for maintenance cables.

⑤ Options			
Name	Option code	Reference page	Standard price
Brake	B	-	-
CE marking	CE	Please refer to our website for the details of the options.	-
Non-motor end specification	NM		-
Motor side-mounted to the left (Standard)	ML		-
Motor side-mounted to the right	MR		-
Slider roller specification	SR		-

Actuator Specifications	
Item	Description
Drive system	Ball screw Ø12mm, rolled C10
Positioning repeatability	±0.02mm
Lost motion	0.1mm or less
Base	Material: Aluminum with white alumite treatment
Static allowable moment	Ma: 50.4N·m, Mb: 71.9N·m, Mc: 138.0N·m
Dynamic allowable moment (*)	Ma: 20.7N·m, Mb: 29.6N·m, Mc: 56.7N·m
Ambient operating temperature, humidity	0 to 40°C, 85% RH or less (Non-condensing)

*Reference for overhang load length/Ma: 230mm or less, Mb, Mc: 230mm or less
 (*) Assumes a standard rated life of 5,000km. The operational life will vary depending on operation and installation conditions.
 Please refer to our website for more information regarding the service life of the products, directions of the allowable moment, and overhang load length.

Dimensions

CAD drawings can be downloaded from our website, www.intelligentactuator.com



*The reference surface is the same as that for SA7C type. (Please refer to P.24)

*The reference offset position for allowable moment calculation is the same as that for SA7C type. (Please refer to P.24)

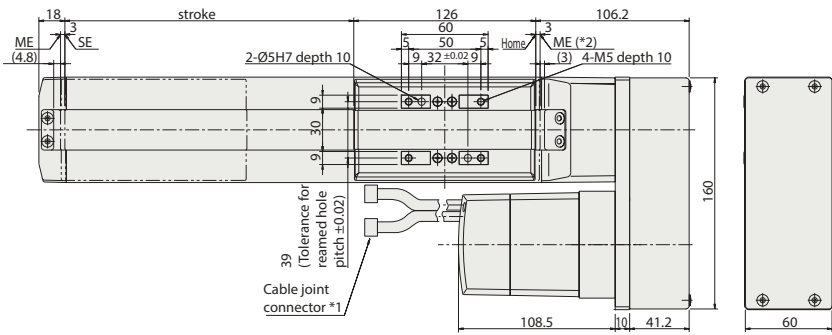
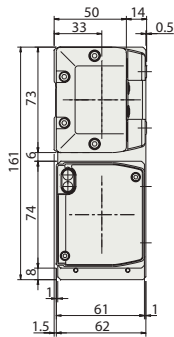

Dimensions for the brake part

*The total length for brake-equipped type is 43mm, and the weight increases by 0.6kg.

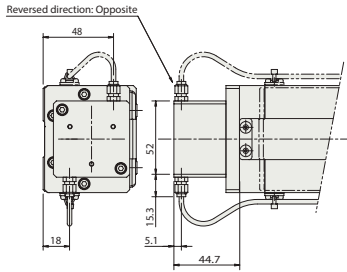

*The brake cable exit direction is the same as the side-mounted motor direction.

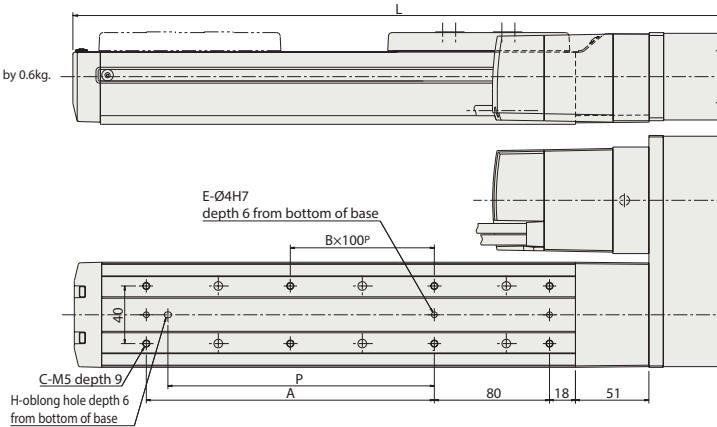
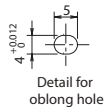

*1 Connects the motor-encoder cable. Please refer to P.84 for the details of the cables.

*2 When the slider is returning to its home position, please be careful of interference from surrounding objects, as it will travel until it reaches the ME.
ME: Mechanical end SE: Stroke end

■ Dimensions and Mass by Stroke

Stroke	50	100	150	200	250	300	350	400	450	500	550	600	650	700	750	800
L	300.2	350.2	400.2	450.2	500.2	550.2	600.2	650.2	700.2	750.2	800.2	850.2	900.2	950.2	1,000.2	1,050.2
A	0	100	100	200	200	300	300	400	400	500	500	600	600	700	700	800
B	0	0	0	1	1	2	2	3	3	4	4	5	5	6	6	7
C	4	6	6	8	8	10	10	12	12	14	14	16	16	18	18	20
D	2	3	3	3	3	3	3	3	3	3	3	3	3	3	3	3
H	0	1	1	1	1	1	1	1	1	1	1	1	1	1	1	1
P	0	85	85	185	185	285	285	385	385	485	485	585	585	685	685	785
Mass (kg)	4.0	4.2	4.4	4.6	4.9	5.1	5.3	5.5	5.8	6.0	6.2	6.4	6.7	6.9	7.1	7.3

RCS2-RA5C

ROBO Cylinder, Rod Type, Actuator Width 55mm, 200V Servo Motor, Coupled Motor Specification

Model Specification Items	Series	Type	Encoder type	Motor type	Lead	Stroke	Applicable controller	Cable length	Options
	RCS2	RA5C	WA: Battery-less absolute	60: Servo motor 60W 100: Servo motor 100W	16: 16mm 8: 8mm 4: 4mm	50: 50mm 300: 300mm (Can be set in 50mm increments)	T2: SCON-CB	N: No cable P: 1m S: 3m M: 5m X□□: Specified length R□□: Robot cable	Please refer to the options table below.

*Controller is not included.



* CE marking is an option.

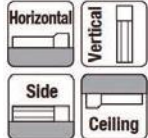

* Depending on the model, there may be some limitations to using the vertical mount position. Please contact for more information regarding mounting positions.

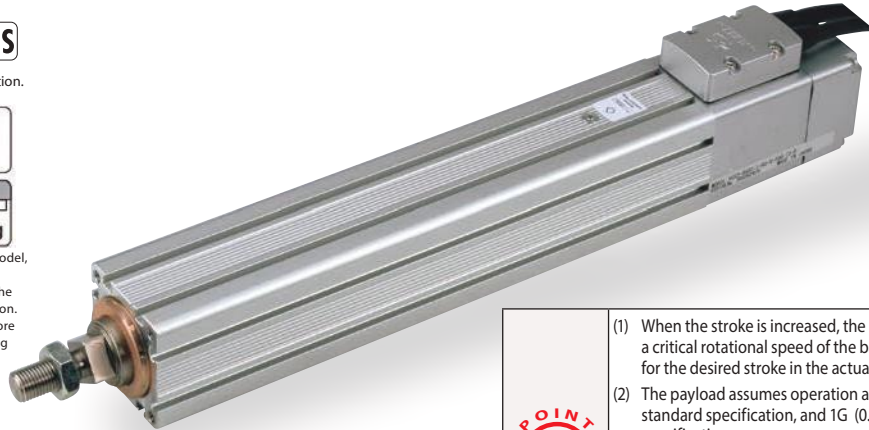

High Accel./Decel. Option

(*1 Excludes all 60W models and lead 4 of 100W model)

- POINT**
Note on selection
- When the stroke is increased, the maximum speed will drop to prevent reaching a critical rotational speed of the ball screw. Please confirm the maximum speed for the desired stroke in the actuator specifications table below.
 - The payload assumes operation at an acceleration of 0.3G (0.2G for lead 4) for standard specification, and 1G (0.2G for lead 4) for high accel./decel. specification. (The values shown in the table below are the upper limit for the maximum payload even if acceleration/deceleration is decreased.)
 - The value of the horizontal payload assumes that no external force is applied to the rod from any direction other than the moving direction by using the external guide(s).
 - Please refer to our website for more information about push-motion operation.

Actuator Specifications

Lead and Payload

Model number	Motor (W)	Lead (mm)	Maximum payload		Rated thrust (N)	Stroke (mm)
			Horizontal (kg)	Vertical (kg)		
RCS2-RA5C-①-60-16-②-③-④-⑤	60	16	12.0	2.0	63.8	50~300 (Every 50mm)
RCS2-RA5C-①-60-8-②-③-④-⑤		8	25.0	5.0	127.5	
RCS2-RA5C-①-60-4-②-③-④-⑤		4	50.0	11.5	255.1	
RCS2-RA5C-①-100-16-②-③-④-⑤	100	16	15.0	3.5	105.8	
RCS2-RA5C-①-100-8-②-③-④-⑤		8	30.0	9.0	212.7	
RCS2-RA5C-①-100-4-②-③-④-⑤		4	60.0	18.0	424.3	

Legend: ① Encoder type ② Stroke ③ Applicable controller ④ Cable length ⑤ Options

Stroke and Maximum Speed

Stroke / Lead	50~250 (Every 50mm)	300 (mm)
	16	800
8	400	377
4	200	188

(Unit: mm/s)

① Encoder Type / ② Stroke

Stroke (mm)	Standard price	
	Encoder type	
	Battery-less absolute	
	Motor wattage	
	60W	100W
50	-	-
100	-	-
150	-	-
200	-	-
250	-	-
300	-	-

④ Cable Length

Type	Cable code	Standard price
Standard type	P (1m)	-
	S (3m)	-
	M (5m)	-
Special length	X06 (6m) ~ X10 (10m)	-
	X11 (11m) ~ X15 (15m)	-
	X16 (16m) ~ X20 (20m)	-
Robot cable	R01 (1m) ~ R03 (3m)	-
	R04 (4m) ~ R05 (5m)	-
	R06 (6m) ~ R10 (10m)	-
	R11 (11m) ~ R15 (15m)	-
	R16 (16m) ~ R20 (20m)	-

*Please refer to P. 84 for maintenance cables.

⑤ Options

Name	Option code	Reference page	Standard price
Cable exit direction change	A2	Please refer to our website for the details of the options.	-
Brake	B		-
CE marking	CE		-
Flange	FL		-
Foot bracket	FT		-
High acceleration/deceleration (*1)	HA		-

High-acceleration/deceleration option cannot be chosen for all 60W models and lead 4 of 100W model.

Actuator Specifications

Item	Description
Drive system	Ball screw Ø12mm, rolled C10
Positioning repeatability	±0.02mm
Lost motion	0.1mm or less
Base	Material: Aluminum with white alumite treatment
Rod diameter	Ø30mm
Rod non-rotation precision	±0.7 deg.
Ambient operating temperature, humidity	0 to 40°C, 85% RH or less (Non-condensing)

Dimensions

CAD drawings can be downloaded from our website, www.intelligentactuator.com



*Note that RA5C type cannot have the non-motor end specification due to its structure.

- *1 Connects the motor-encoder cable. Please refer to P. 84 for the details of the cables.
- *2 When the rod is returning to its home position, please be careful of interference from surrounding objects, as it will travel until it reaches the ME.
- ME: Mechanical end SE: Stroke end
- *3 The direction of width across flats varies depending on the product.

[Without a brake]

Note
Do not apply an external force to the rod from any direction other than the moving direction of the rod. If a force is applied to the rod from the direction perpendicular to the rod or rotating direction of the rod, the stopper may be damaged.

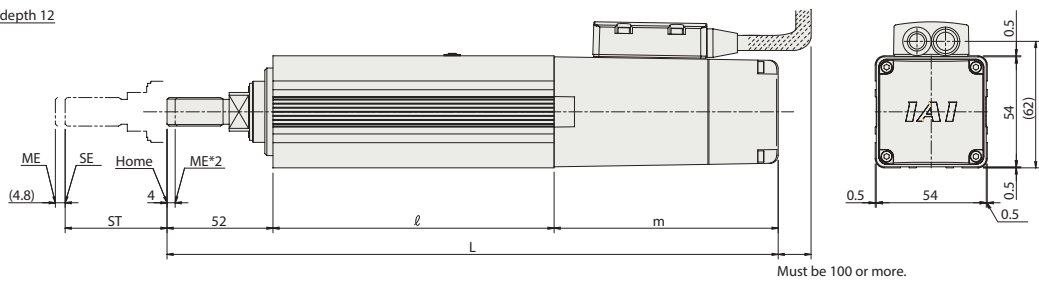
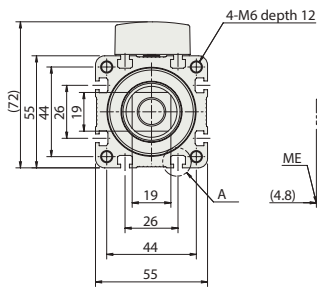
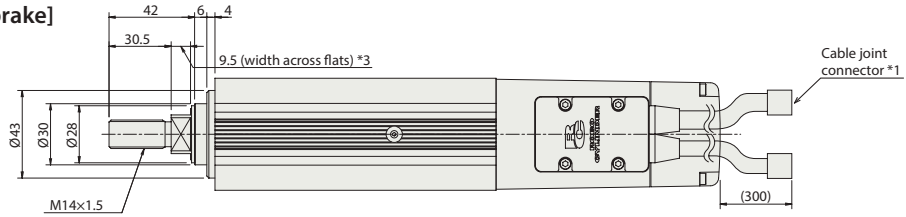

[With a brake]

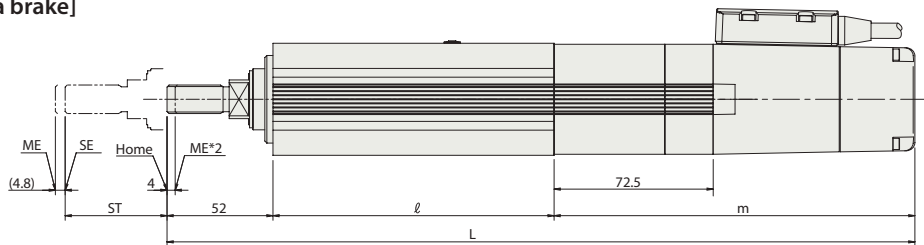
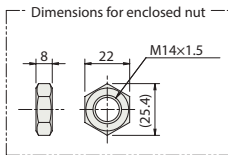
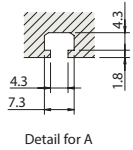

■ Dimensions and Mass by Stroke

RCS2-RA5C (Without brake)

Stroke	50	100	150	200	250	300	
L	60W	282	332	382	432	482	532
	100W	300	350	400	450	500	550
ℓ	138	188	238	288	338	388	
m	60W	92					
	100W	110					
Mass (kg)	1.9	2.2	2.5	2.8	3.1	3.4	

RCS2-RA5C (With brake)

Stroke	50	100	150	200	250	300	
L	60W	354.5	404.5	454.5	504.5	554.5	604.5
	100W	372.5	422.5	472.5	522.5	572.5	622.5
ℓ	138	188	238	288	338	388	
m	60W	164.5					
	100W	182.5					
Mass (kg)	2.2	2.5	2.8	3.1	3.4	3.7	

RCS2-RA5R

ROBO Cylinder, Rod Type, Actuator Width 55mm, 200V Servo Motor, Side-mounted Motor Specification

Model Specification Items	RCS2	RA5R	<input type="checkbox"/>	60	<input type="checkbox"/>	<input type="checkbox"/>	<input type="checkbox"/>	<input type="checkbox"/>	<input type="checkbox"/>
	Series	Type	Encoder type	Motor type	Lead	Stroke	Applicable controller	Cable length	Options
			WA: Battery-less absolute	60: Servo motor 60W	16: 16mm 8: 8mm 4: 4mm	50: 50mm 300: 300mm (Can be set in 50mm increments)	T2: SCON-CB	N: No cable P: 1m S: 3m M: 5m X <input type="checkbox"/> : Specified length R <input type="checkbox"/> : Robot cable	Please refer to the options table below. * Please specify which side the motor is to be mounted (ML/MR)

*Controller is not included.



* CE marking is an option.

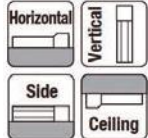

* Depending on the model, there may be some limitations to using the vertical mount position. Please contact for more information regarding mounting positions.

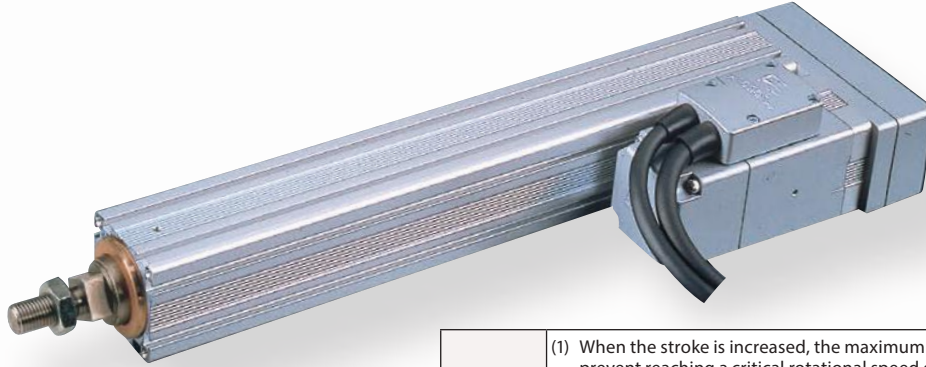

- POINT**
Note on selection
- When the stroke is increased, the maximum speed will drop to prevent reaching a critical rotational speed of the ball screw. Please confirm the maximum speed for the desired stroke in the actuator specifications table below.
 - The payload assumes operation at an acceleration of 0.3G (0.2G for lead 4). This is the upper limit of the acceleration.
 - The value of the horizontal payload assumes that no external force is applied to the rod from any direction other than the moving direction by using the external guide(s).
 - Please refer to our website for more information about push-motion operation.

Actuator Specifications

Lead and Payload

Model number	Motor (W)	Lead (mm)	Maximum payload		Rated thrust (N)	Stroke (mm)
			Horizontal (kg)	Vertical (kg)		
RCS2-RA5R-①-60-16-②-③-④-⑤	60	16	12.0	2.0	63.8	50~300 (Every 50mm)
RCS2-RA5R-①-60-8-②-③-④-⑤		8	25.0	5.0	127.5	
RCS2-RA5R-①-60-4-②-③-④-⑤		4	50.0	11.5	255.1	

Legend: ① Encoder type ② Stroke ③ Applicable controller ④ Cable length ⑤ Options

Stroke and Maximum Speed

Stroke / Lead	50~250 (Every 50mm)	300 (mm)
	16	800
8	400	377
4	200	188

(Unit: mm/s)

① Encoder Type / ② Stroke

Stroke (mm)	Standard price
	Encoder type
Battery-less absolute	-
WA	-
50	-
100	-
150	-
200	-
250	-
300	-

④ Cable Length

Type	Cable code	Standard price
Standard type	P (1m)	-
	S (3m)	-
	M (5m)	-
Special length	X06 (6m) ~X10 (10m)	-
	X11 (11m) ~X15 (15m)	-
	X16 (16m) ~X20 (20m)	-
	R01 (1m) ~R03 (3m)	-
Robot cable	R04 (4m) ~R05 (5m)	-
	R06 (6m) ~R10 (10m)	-
	R11 (11m) ~R15 (15m)	-
	R16 (16m) ~R20 (20m)	-
	-	-

*Please refer to P. 84 for maintenance cables.

⑤ Options

Name	Option code	Reference page	Standard price
Cable exit direction change	A2	Please refer to our website for the details of the options.	-
Brake	B		-
CE marking	CE		-
Flange	FL		-
Foot bracket	FT		-
Motor side-mounted to the left (Standard)	ML		-
Motor side-mounted to the right	MR		-

Actuator Specifications

Item	Description
Drive system	Ball screw Ø12mm, rolled C10
Positioning repeatability	±0.02mm
Lost motion	0.1mm or less
Base	Material: Aluminum with white alumite treatment
Rod diameter	Ø30mm
Rod non-rotation precision	±0.7 deg.
Ambient operating temperature, humidity	0 to 40°C, 85% RH or less (Non-condensing)

Dimensions

CAD drawings can be downloaded from our website, www.intelligentactuator.com



*Note that RA5R type cannot have the non-motor end specification due to its structure.

- *1 Connects the motor-encoder cable. Please refer to P.84 for the details of the cables.
- *2 When the rod is returning to its home position, please be careful of interference from surrounding objects, as it will travel until it reaches the ME.
- ME: Mechanical end SE: Stroke end
- *3 The direction of width across flats varies depending on the product.

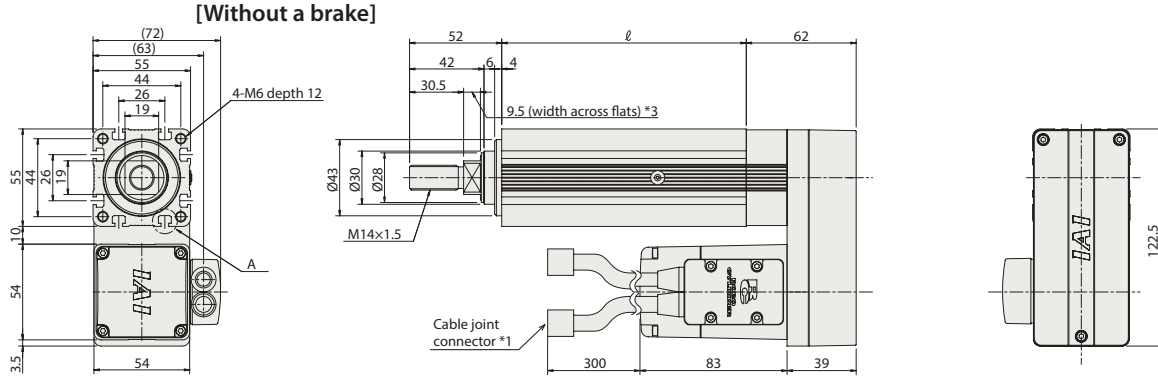

Note
Do not apply an external force to the rod from any direction other than the moving direction of the rod. If a force is applied to the rod from the direction perpendicular to the rod or rotating direction of the rod, the stopper may be damaged.

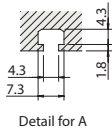
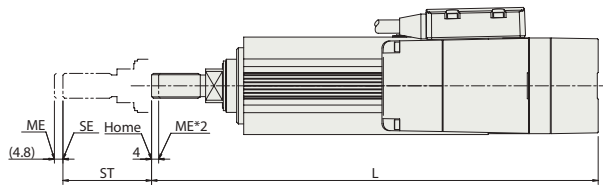

[With a brake]

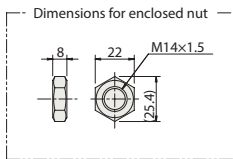
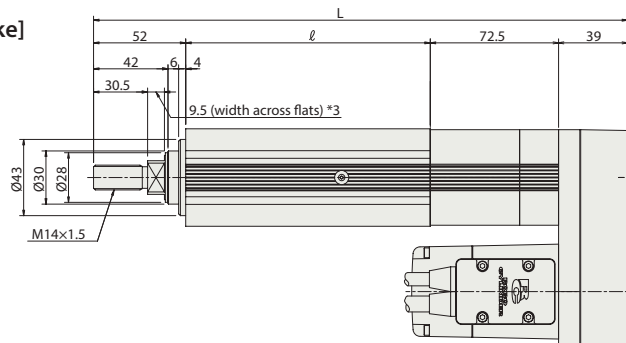

■Dimensions and Mass by Stroke

RCS2-RA5R (Without brake)

Stroke	50	100	150	200	250	300
L	252	302	352	402	452	502
ℓ	138	188	238	288	338	388
Mass (kg)	2.3	2.6	2.9	3.2	3.5	3.8

RCS2-RA5R (With brake)

Stroke	50	100	150	200	250	300
L	301.5	351.5	401.5	451.5	501.5	551.5
ℓ	138	188	238	288	338	388
Mass (kg)	2.6	2.9	3.2	3.5	3.8	4.1

RCS3-SA8C

ROBO Cylinder, Slider Type, Actuator Width 80mm, 200V Servo Motor, Coupled Motor, Aluminum Base

Model Specification Items	RCS3 Series	SA8C Type	Encoder type	Motor type	Lead	Stroke	Applicable controller	Cable length	Options
			WA: Battery-less absolute	100: Servo motor 100W 150: Servo motor 150W	30: 30mm 20: 20mm 10: 10mm 5: 5mm	50: 50mm 1100: 1,100mm (Can be set in 50mm increments)	T2: SCON-CB	N: No cable P: 1m S: 3m M: 5m X□□: Specified length R□□: Robot cable	Please refer to the options table below. * Please specify a code indicating your desired cable exit direction.

*Controller is not included.



* CE marking is an option.

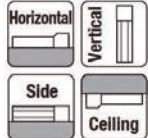

* Depending on the model, there may be some limitations to using the vertical, side, and ceiling mount positions. Please contact for more information regarding mounting positions.



- POINT**
Note on selection
- When the stroke is increased, the maximum speed will drop to prevent reaching a critical rotational speed of the ball screw. Please confirm the maximum speed for the desired stroke in the actuator specifications table below.
 - The payload assumes operation at an acceleration of 0.3G (0.2G for lead 5) for horizontal, and 0.2G for vertical use.
 - The payload drops when the acceleration is increased.
 - Please refer to our website for more information about push-motion operation.

Actuator Specifications

Lead and Payload

Model number	Motor (W)	Lead (mm)	Maximum payload		Rated thrust (N)	Stroke (mm)
			Horizontal (kg)	Vertical (kg)		
RCS3-SA8C-①-100-30-②-③-④-⑤	100	30	8	2	56.6	50~1,100 (Every 50mm)
RCS3-SA8C-①-100-20-②-③-④-⑤		20	20	4	84.9	
RCS3-SA8C-①-100-10-②-③-④-⑤		10	40	8	169.8	
RCS3-SA8C-①-100-5-②-③-④-⑤		5	80	16	339.7	
RCS3-SA8C-①-150-30-②-③-④-⑤	150	30	12	3	85.1	
RCS3-SA8C-①-150-20-②-③-④-⑤		20	30	6	127.6	
RCS3-SA8C-①-150-10-②-③-④-⑤		10	60	12	255.3	

Legend: ① Encoder type ② Stroke ③ Applicable controllers ④ Cable length ⑤ Options

Stroke and Maximum Speed (Unit: mm/s)

Stroke / Lead	Stroke (mm)									
	50-650 (Every 50mm)	700	750	800	850	900	950	1,000	1,050	1,100
30	1,800	1,610	1,420	1,260	1,120	1,010	910	830	760	690
20	1,200	1,070	940	840	750	670	610	550	500	460
10	600	530	470	410	370	340	310	270	250	230
5	300	260	230	200	180	170	150	135	120	110

① Encoder Type / ② Stroke

Stroke (mm)	Standard price	
	Encoder type	
	Battery-less absolute Motor wattage	
	100W	150W
50/100	-	-
150/200	-	-
250/300	-	-
350/400	-	-
450/500	-	-
550/600	-	-
650/700	-	-
750/800	-	-
850/900	-	-
950/1,000	-	-
1,050/1,100	-	-

④ Cable Length

Type	Cable code	Standard price
Standard type	P (1m)	-
	S (3m)	-
	M (5m)	-
Special length	X06 (6m) ~X10 (10m)	-
	X11 (11m) ~X15 (15m)	-
	X16 (16m) ~X20 (20m)	-
Robot cable	R01 (1m) ~R03 (3m)	-
	R04 (4m) ~R05 (5m)	-
	R06 (6m) ~R10 (10m)	-
	R11 (11m) ~R15 (15m)	-
	R16 (16m) ~R20 (20m)	-

*Please refer to P. 84 for maintenance cables.

⑤ Options

Name	Option code	Reference page	Standard price
Cables exit from back left	A1E	Please refer to our website for the details of the options.	-
Cables exit from left side	A1S		-
Cables exit from back right	A3E		-
Cables exit from right side	A3S		-
Brake	B		-
CE marking	CE	-	
Non-motor end specification	NM	-	

Actuator Specifications

Item	Description
Drive system	Ball screw Ø16mm, rolled C10
Positioning repeatability	±0.02mm
Lost motion	0.1mm or less
Base	Material: Aluminum with white alumite treatment
Static allowable moment	Ma: 113.5N·m, Mb: 177N·m, Mc: 266N·m
Dynamic allowable moment (*)	Ma: 26.9N·m, Mb: 38.4N·m, Mc: 63.1N·m
Ambient operating temperature, humidity	0 to 40°C, 85% RH or less (Non-condensing)

*Reference for overhang load length/Ma: 390mm or less, Mb, Mc: 390mm or less
 (*) Assumes a standard rated life of 10,000km. The operational life will vary depending on operation and installation conditions.
 Please refer to our website for more information regarding the service life of the products, directions of the allowable moment, and overhang load length.

Dimensions

CAD drawings can be downloaded from our website. www.intelligentactuator.com



- *1 Connects the motor-encoder cable. Please refer to P.84 for the details of the cables.
- *2 When the slider is returning to its home position, please be careful of interference from surrounding objects, as it will travel until it reaches the ME.
- ME: Mechanical end SE: Stroke end
- *3 Reference position used when calculating the Ma moment.

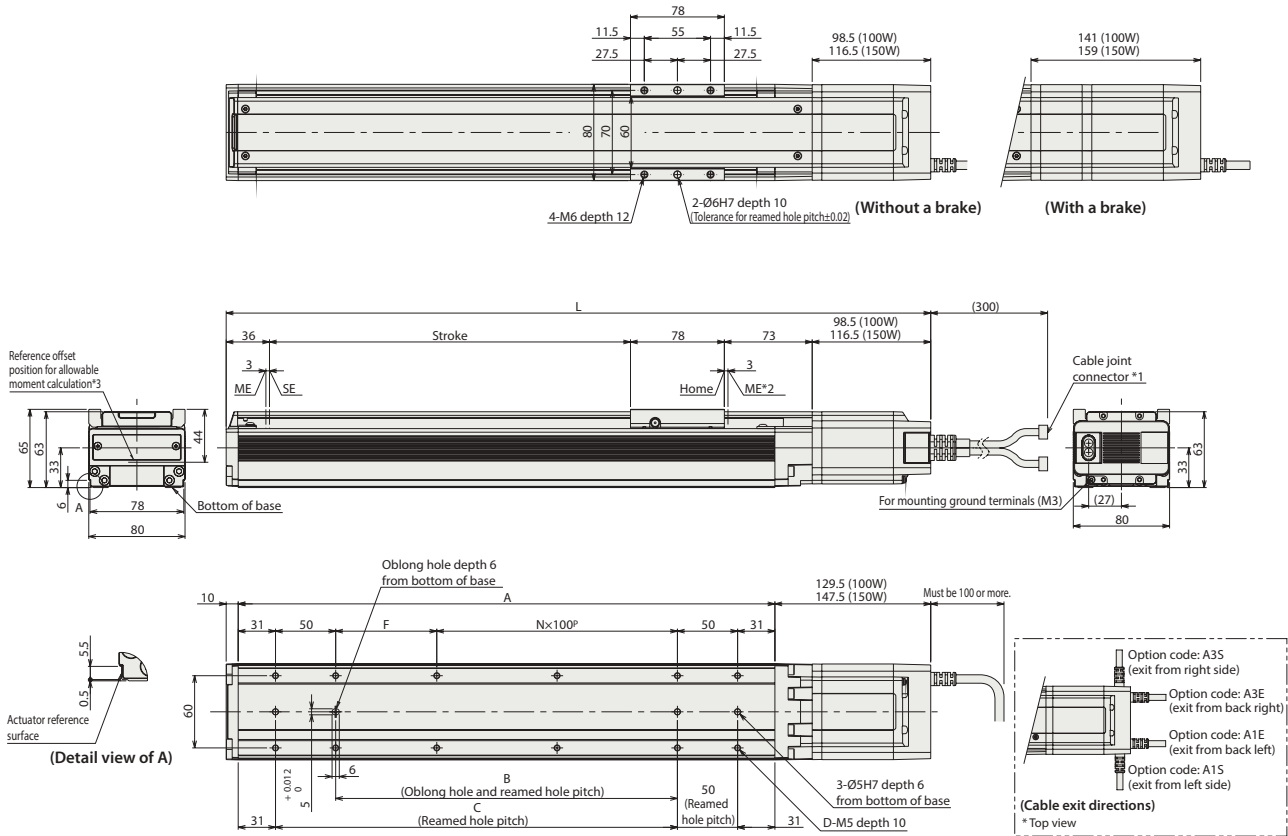

■ Dimensions and Mass by Stroke

Stroke	Stroke																						
	50	100	150	200	250	300	350	400	450	500	550	600	650	700	750	800	850	900	950	1,000	1,050	1,100	
L	100W Without brake	335.5	385.5	435.5	485.5	535.5	585.5	635.5	685.5	735.5	785.5	835.5	885.5	935.5	985.5	1,035.5	1,085.5	1,135.5	1,185.5	1,235.5	1,285.5	1,335.5	1,385.5
	100W With brake	378	428	478	528	578	628	678	728	778	828	878	928	978	1,028	1,078	1,128	1,178	1,228	1,278	1,328	1,378	1,428
L	150W Without brake	353.5	403.5	453.5	503.5	553.5	603.5	653.5	703.5	753.5	803.5	853.5	903.5	953.5	1,003.5	1,053.5	1,103.5	1,153.5	1,203.5	1,253.5	1,303.5	1,353.5	1,403.5
	150W With brake	396	446	496	546	596	646	696	746	796	846	896	946	996	1,046	1,096	1,146	1,196	1,246	1,296	1,346	1,396	1,446
A		196	246	296	346	396	446	496	546	596	646	696	746	796	846	896	946	996	1,046	1,096	1,146	1,196	1,246
B		34	84	134	184	234	284	334	384	434	484	534	584	634	684	734	784	834	884	934	984	1,034	1,084
C		84	134	184	234	284	334	384	434	484	534	584	634	684	734	784	834	884	934	984	1,034	1,084	1,134
D		8	8	10	10	12	12	14	14	16	16	18	18	20	20	22	22	24	24	26	26	28	28
F		34	84	34	84	34	84	34	84	34	84	34	84	34	84	34	84	34	84	34	84	34	84
N		0	0	1	1	2	2	3	3	4	4	5	5	6	6	7	7	8	8	9	9	10	10
Mass (kg)	100W Without brake	2.9	3.2	3.5	3.8	4.1	4.4	4.7	5.0	5.3	5.6	5.9	6.2	6.5	6.8	7.1	7.4	7.7	8.0	8.3	8.6	8.9	9.2
	100W With brake	3.3	3.6	3.9	4.2	4.5	4.8	5.1	5.4	5.7	6.0	6.3	6.6	6.9	7.2	7.5	7.8	8.1	8.4	8.7	9.0	9.3	9.6
Mass (kg)	150W Without brake	3.0	3.3	3.6	3.9	4.2	4.5	4.8	5.1	5.4	5.7	6.0	6.3	6.6	6.9	7.2	7.5	7.8	8.1	8.4	8.7	9.0	9.3
	150W With brake	3.5	3.8	4.1	4.4	4.7	5.0	5.3	5.6	5.9	6.2	6.5	6.8	7.1	7.4	7.7	8.0	8.3	8.6	8.9	9.2	9.5	9.8

RCS3-SS8C

ROBO Cylinder, Slider Type, Actuator Width 80mm, 200V Servo Motor, Coupled Motor, Steel Base

Model Specification Items	RCS3	SS8C	Encoder type	Motor type	Lead	Stroke	Applicable controller	Cable length	Options
Series	RCS3	SS8C							
Encoder type			WA: Battery-less absolute	100: Servo motor 100W 150: Servo motor 150W	30: 30mm 20: 20mm 10: 10mm 5: 5mm	50: 50mm 1000: 1,000mm (Can be set in 50mm increments)	T2: SCON-CB	N: No cable P: 1m S: 3m M: 5m X□□: Specified length R□□: Robot cable	Please refer to the options table below. * Please specify a code indicating your desired cable exit direction.

*Controller is not included.



* CE marking is an option.

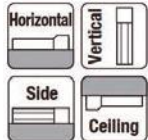

* Depending on the model, there may be some limitations to using the vertical, side, and ceiling mount positions. Please contact for more information regarding mounting positions.



- POINT**
Note on selection
- (1) When the stroke is increased, the maximum speed will drop to prevent reaching a critical rotational speed of the ball screw. Please confirm the maximum speed for the desired stroke in the actuator specifications table below.
 - (2) The payload assumes operation at an acceleration of 0.3G (0.2G for lead 5) for horizontal, and 0.2G for vertical use.
 - (3) The payload drops when the acceleration is increased.
 - (4) Please refer to our website for more information about push-motion operation.

Actuator Specifications

Lead and Payload

Model number	Motor (W)	Lead (mm)	Maximum payload		Rated thrust (N)	Stroke (mm)
			Horizontal (kg)	Vertical (kg)		
RCS3-SS8C-①-100-30-②-③-④-⑤	100	30	8	2	56.6	50~1,000 (Every 50mm)
RCS3-SS8C-①-100-20-②-③-④-⑤		20	20	4	84.9	
RCS3-SS8C-①-100-10-②-③-④-⑤		10	40	8	169.8	
RCS3-SS8C-①-100-5-②-③-④-⑤		5	80	16	339.7	
RCS3-SS8C-①-150-30-②-③-④-⑤	150	30	12	3	85.1	
RCS3-SS8C-①-150-20-②-③-④-⑤		20	30	6	127.6	
RCS3-SS8C-①-150-10-②-③-④-⑤		10	60	12	255.3	

Legend: ① Encoder type ② Stroke ③ Applicable controllers ④ Cable length ⑤ Options

Stroke and Maximum Speed (Unit: mm/s)

Stroke / Lead	Maximum Speed (mm/s)								
	50-600 (Every 50mm)	650	700	750	800	850	900	950	1,000
30	1,800	1,660	1,460	1,295	1,155	1,035	935	850	775
20	1,200	1,105	970	860	770	690	625	565	515
10	600	550	485	430	385	345	310	280	255
5	300	275	240	215	190	170	150	140	125

① Encoder Type / ② Stroke

Stroke (mm)	Standard price	
	Encoder type	
	Battery-less absolute Motor wattage	
	100W	150W
50/100	-	-
150/200	-	-
250/300	-	-
350/400	-	-
450/500	-	-
550/600	-	-
650/700	-	-
750/800	-	-
850/900	-	-
950/1,000	-	-

④ Cable Length

Type	Cable code	Standard price
Standard type	P (1m)	-
	S (3m)	-
	M (5m)	-
Special length	X06 (6m) ~X10 (10m)	-
	X11 (11m) ~X15 (15m)	-
	X16 (16m) ~X20 (20m)	-
	R01 (1m) ~R03 (3m)	-
Robot cable	R04 (4m) ~R05 (5m)	-
	R06 (6m) ~R10 (10m)	-
	R11 (11m) ~R15 (15m)	-
	R16 (16m) ~R20 (20m)	-

*Please refer to P. 84 for maintenance cables.

⑤ Options

Name	Option code	Reference page	Standard price
Cables exit from back left	A1E	Please refer to our website for the details of the options.	-
Cables exit from left side	A1S		-
Cables exit from back right	A3E		-
Cables exit from right side	A3S		-
Brake	B		-
CE marking	CE		-
Non-motor end specification	NM		-
Slider roller specification	SR		-

Actuator Specifications

Item	Description
Drive system	Ball screw Ø16mm, rolled C10
Positioning repeatability	±0.02mm
Lost motion	0.1mm or less
Base	Material: Dedicated alloy steel
Static allowable moment	Ma: 198.9N·m, Mb: 198.9N·m, Mc: 416.7N·m
Dynamic allowable moment (*)	Ma: 43.4N·m, Mb: 43.4N·m, Mc: 90.9N·m
Ambient operating temperature, humidity	0 to 40°C, 85% RH or less (Non-condensing)

*Reference for overhang load length/Ma: 450mm or less, Mb, Mc: 450mm or less
 (*) Assumes a standard rated life of 10,000km. The operational life will vary depending on operation and installation conditions.

Please refer to our website for more information regarding the service life of the products, directions of the allowable moment, and overhang load length.

Dimensions

CAD drawings can be downloaded from our website. www.intelligentactuator.com



- *1 Connects the motor-encoder cable. Please refer to P.84 for the details of the cables.
- *2 When the slider is returning to its home position, please be careful of interference from surrounding objects, as it will travel until it reaches the ME.
- ME: Mechanical end SE: Stroke end
- *3 Reference position used when calculating the Ma moment.

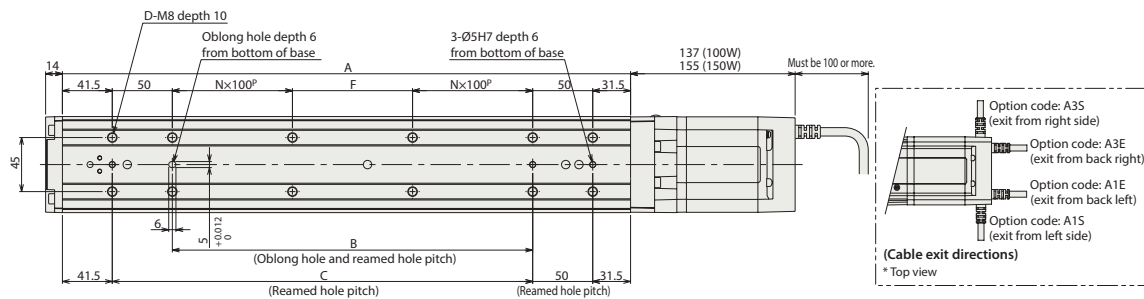
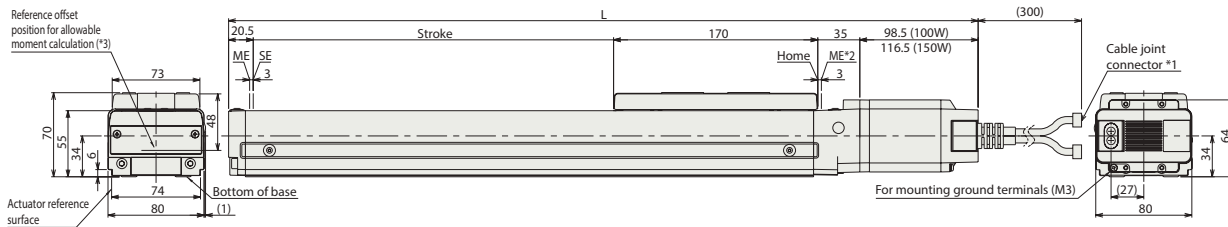
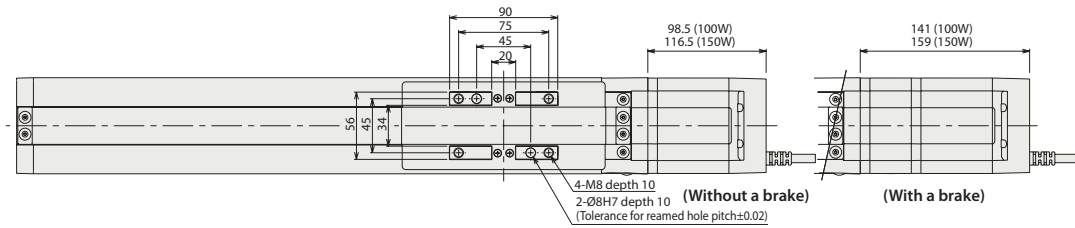

■Dimensions and Mass by Stroke

	Stroke	Stroke																				
		50	100	150	200	250	300	350	400	450	500	550	600	650	700	750	800	850	900	950	1,000	
L	100W	Without brake	374	424	474	524	574	624	674	724	774	824	874	924	974	1,024	1,074	1,124	1,174	1,224	1,274	1,324
		With brake	416.5	466.5	516.5	566.5	616.5	666.5	716.5	766.5	816.5	866.5	916.5	966.5	1,016.5	1,066.5	1,116.5	1,166.5	1,216.5	1,266.5	1,316.5	1,366.5
	150W	Without brake	392	442	492	542	592	642	692	742	792	842	892	942	992	1,042	1,092	1,142	1,192	1,242	1,292	1,342
		With brake	434.5	484.5	534.5	584.5	634.5	684.5	734.5	784.5	834.5	884.5	934.5	984.5	1,034.5	1,084.5	1,134.5	1,184.5	1,234.5	1,284.5	1,334.5	1,384.5
A		223	273	323	373	423	473	523	573	623	673	723	773	823	873	923	973	1,023	1,073	1,123	1,173	
B		50	100	150	200	250	300	350	400	450	500	550	600	650	700	750	800	850	900	950	1,000	
C		100	150	200	250	300	350	400	450	500	550	600	650	700	750	800	850	900	950	1,000	1,050	
D		8	8	8	10	12	12	12	14	16	16	16	18	20	20	20	22	24	24	24	26	
F		50	100	150	0	50	100	150	0	50	100	150	0	50	100	150	0	50	100	150	0	
N		0	0	0	1	1	1	1	2	2	2	3	3	3	3	4	4	4	4	5	5	
Mass (kg)	100W	Without brake	5.1	5.6	6.2	6.7	7.3	7.8	8.4	8.9	9.5	10.0	10.6	11.1	11.7	12.2	12.8	13.3	13.9	14.4	15.0	15.5
		With brake	5.5	6.0	6.6	7.1	7.7	8.2	8.8	9.3	9.9	10.4	11.0	11.5	12.1	12.6	13.2	13.7	14.3	14.8	15.4	15.9
	150W	Without brake	5.1	5.7	6.2	6.8	7.3	7.9	8.4	9.0	9.5	10.1	10.6	11.2	11.7	12.3	12.8	13.4	13.9	14.5	15.0	15.6
		With brake	5.6	6.1	6.7	7.2	7.8	8.3	8.9	9.4	10.0	10.5	11.1	11.6	12.2	12.7	13.3	13.8	14.4	14.9	15.5	16.0

RCS3-SA8R

ROBO Cylinder, Slider Type, Actuator Width 80mm, 200V Servo Motor, Side-mounted Motor, Aluminum Base

Model Specification Items	RCS3 Series	SA8R Type	Encoder type	Motor type	Lead	Stroke	Applicable controller	Cable length	Options
			WA: Battery-less absolute	100: Servo motor 100W 150: Servo motor 150W	30: 30mm 20: 20mm 10: 10mm 5: 5mm	50: 50mm 1100: 1,100mm (Can be set in 50mm increments)	T2: SCON-CB	N: No cable P: 1m S: 3m M: 5m X□□: Specified length R□□: Robot cable	Please refer to the options table below. * Please specify a code indicating your desired cable exit direction.

*Controller is not included.



* CE marking is an option.

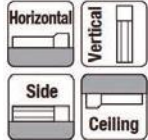

* Depending on the model, there may be some limitations to using the vertical, side, and ceiling mount positions. Please contact for more information regarding mounting positions.



- POINT**
Note on selection
- When the stroke is increased, the maximum speed will drop to prevent reaching a critical rotational speed of the ball screw. Please confirm the maximum speed for the desired stroke in the actuator specifications table below.
 - The payload assumes operation at an acceleration of 0.3G (0.2G for lead 5) for horizontal, and 0.2G for vertical use.
 - The payload drops when the acceleration is increased.
 - Please refer to our website for more information about push-motion operation.

Actuator Specifications

Lead and Payload

Model number	Motor (W)	Lead (mm)	Maximum payload		Rated thrust (N)	Stroke (mm)
			Horizontal (kg)	Vertical (kg)		
RCS3-SA8R-①-100-30-②-③-④-⑤	100	30	8	2	56.6	50~1,100 (Every 50mm)
RCS3-SA8R-①-100-20-②-③-④-⑤		20	20	4	84.9	
RCS3-SA8R-①-100-10-②-③-④-⑤		10	40	8	169.8	
RCS3-SA8R-①-100-5-②-③-④-⑤		5	80	16	339.7	
RCS3-SA8R-①-150-30-②-③-④-⑤	150	30	12	3	85.1	
RCS3-SA8R-①-150-20-②-③-④-⑤		20	30	6	127.6	
RCS3-SA8R-①-150-10-②-③-④-⑤		10	60	12	255.3	

Legend: ① Encoder type ② Stroke ③ Applicable controller ④ Cable length ⑤ Options

Stroke and Maximum Speed (Unit: mm/s)

Stroke / Lead	Stroke (mm)									
	50~650 (Every 50mm)	700	750	800	850	900	950	1,000	1,050	1,100
30	1,800	1,610	1,420	1,260	1,120	1,010	910	830	760	690
20	1,200	1,070	940	840	750	670	610	550	500	460
10	600	530	470	410	370	340	310	270	250	230
5	300	260	230	200	180	170	150	135	120	110

① Encoder Type / ② Stroke

Stroke (mm)	Standard price	
	Encoder type	
	Battery-less absolute Motor wattage	
	100W	150W
50/100	-	-
150/200	-	-
250/300	-	-
350/400	-	-
450/500	-	-
550/600	-	-
650/700	-	-
750/800	-	-
850/900	-	-
950/1,000	-	-
1,050/1,100	-	-

④ Cable Length

Type	Cable code	Standard price
Standard type	P (1m)	-
	S (3m)	-
	M (5m)	-
Special length	X06 (6m) ~X10 (10m)	-
	X11 (11m) ~X15 (15m)	-
	X16 (16m) ~X20 (20m)	-
Robot cable	R01 (1m) ~R03 (3m)	-
	R04 (4m) ~R05 (5m)	-
	R06 (6m) ~R10 (10m)	-
	R11 (11m) ~R15 (15m)	-
	R16 (16m) ~R20 (20m)	-

*Please refer to P. 84 for maintenance cables.

⑤ Options

Name	Option code	Reference page	Standard price
Brake	B	Please refer to our website for the details of the options.	-
CE marking	CE		-
Motor mounted on left, cable exit from back	MLE		-
Motor mounted on left, cable exit from side	MLS		-
Motor mounted on right, cable exit from back	MRE		-
Motor mounted on right, cable exit from side	MRS		-
Non-motor end specification	NM		-

Actuator Specifications

Item	Description
Drive system	Ball screw Ø16mm, rolled C10
Positioning repeatability	±0.02mm
Lost motion	0.1mm or less
Base	Material: Aluminum with white alumite treatment
Static allowable moment	Ma: 113.5N·m, Mb: 177N·m, Mc: 266N·m
Dynamic allowable moment (*)	Ma: 26.9N·m, Mb: 38.4N·m, Mc: 63.1N·m
Ambient operating temperature, humidity	0 to 40°C, 85% RH or less (Non-condensing)

*Reference for overhang load length/Ma: 390mm or less, Mb, Mc: 390mm or less
 (*) Assumes a standard rated life of 10,000km. The operational life will vary depending on operation and installation conditions.

Please refer to our website for more information regarding the service life of the products, directions of the allowable moment, and overhang load length.

Dimensions

CAD drawings can be downloaded from our website, www.intelligentactuator.com



- *1 Connects the motor-encoder cable. Please refer to P. 84 for the details of the cables.
- *2 When the slider is returning to its home position, please be careful of interference from surrounding objects, as it will travel until it reaches the ME.
ME: Mechanical end SE: Stroke end
- * Offset reference position for the allowable moment is the same as the one for SA8C type. (Please refer to P. 38)

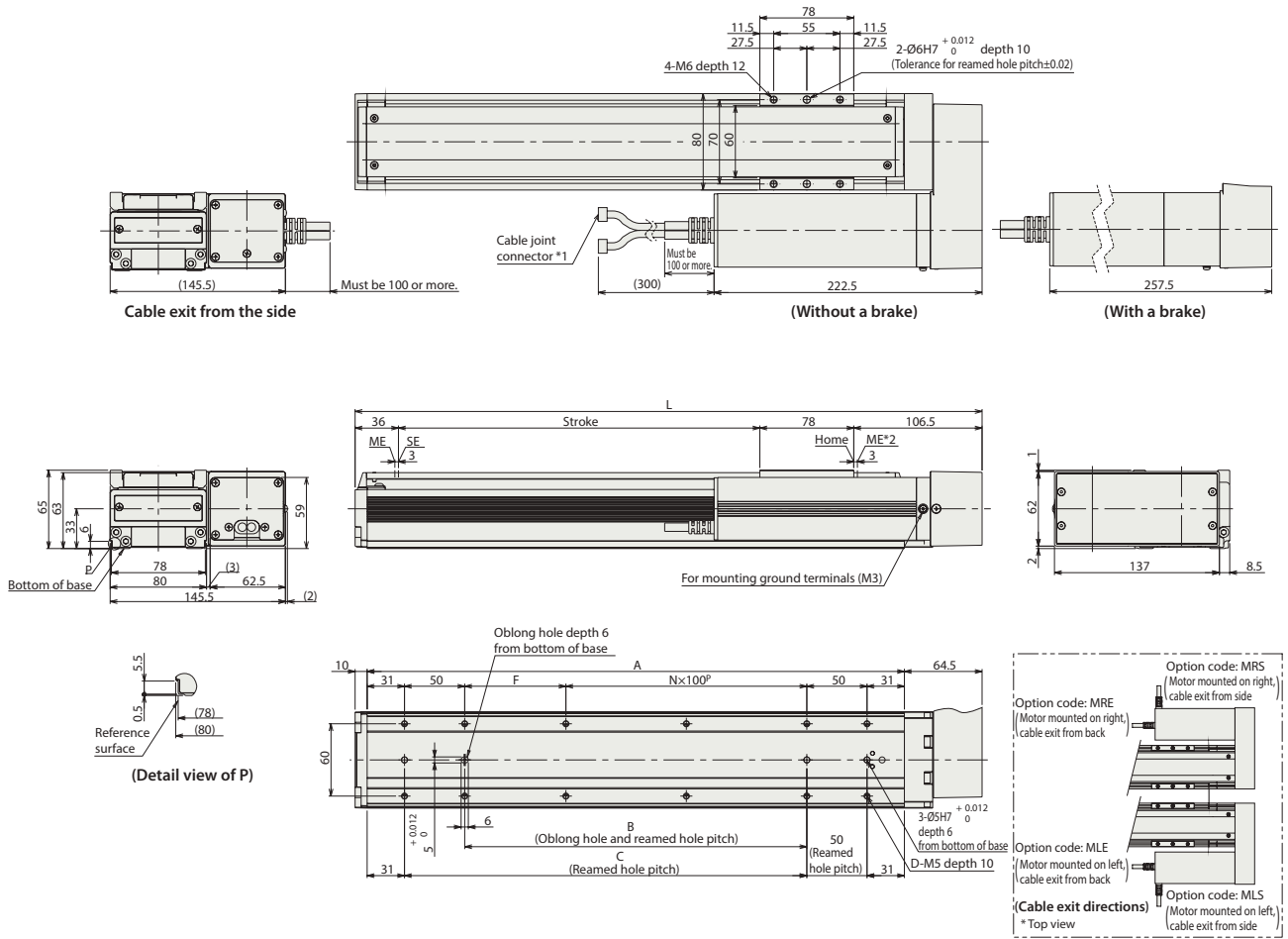

■ Dimensions and Mass by Stroke

Stroke	50	100	150	200	250	300	350	400	450	500	550	600	650	700	750	800	850	900	950	1,000	1,050	1,100		
L	270.5	320.5	370.5	420.5	470.5	520.5	570.5	620.5	670.5	720.5	770.5	820.5	870.5	920.5	970.5	1,020.5	1,070.5	1,120.5	1,170.5	1,220.5	1,270.5	1,320.5		
A	196	246	296	346	396	446	496	546	596	646	696	746	796	846	896	946	996	1,046	1,096	1,146	1,196	1,246		
B	34	84	134	184	234	284	334	384	434	484	534	584	634	684	734	784	834	884	934	984	1,034	1,084		
C	84	134	184	234	284	334	384	434	484	534	584	634	684	734	784	834	884	934	984	1,034	1,084	1,134		
D	8	8	10	10	12	12	14	14	16	16	18	18	20	20	22	22	24	24	26	26	28	28		
F	34	84	34	84	34	84	34	84	34	84	34	84	34	84	34	84	34	84	34	84	34	84		
N	0	0	1	1	2	2	3	3	4	4	5	5	6	6	7	7	8	8	9	9	10	10		
Mass (kg)	100W	Without brake	3.6	3.9	4.2	4.5	4.8	5.1	5.4	5.7	6.0	6.3	6.6	6.9	7.2	7.5	7.8	8.1	8.4	8.7	9.0	9.3	9.6	9.9
		With brake	4.0	4.3	4.6	4.9	5.2	5.5	5.8	6.1	6.4	6.7	7.0	7.3	7.6	7.9	8.2	8.5	8.8	9.1	9.4	9.7	10.0	10.3
	150W	Without brake	3.8	4.1	4.4	4.7	5.0	5.3	5.6	5.9	6.2	6.5	6.8	7.1	7.4	7.7	8.0	8.3	8.6	8.9	9.2	9.5	9.8	10.1
		With brake	4.1	4.4	4.7	5.0	5.3	5.6	5.9	6.2	6.5	6.8	7.1	7.4	7.7	8.0	8.3	8.6	8.9	9.2	9.5	9.8	10.1	10.4

RCS3-SS8R

ROBO Cylinder, Slider Type, Actuator Width 80mm, 200V Servo Motor, Side-mounted Motor, Steel Base

Model Specification Items	RCS3	SS8R	Encoder type	Motor type	Lead	Stroke	Applicable controller	Cable length	Options
Series	RCS3	SS8R							
Encoder type			WA: Battery-less absolute	100: Servo motor 100W 150: Servo motor 150W	30: 30mm 20: 20mm 10: 10mm 5: 5mm	50: 50mm 1000: 1,000mm (Can be set in 50mm increments)	T2: SCON-CB	N: No cable P: 1m S: 3m M: 5m X□□: Specified length R□□: Robot cable	Please refer to the options table below. * Please specify a code indicating your desired cable exit direction.

*Controller is not included.



* CE marking is an option.

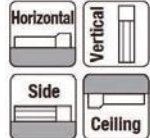

* Depending on the model, there may be some limitations to using the vertical, side, and ceiling mount positions. Please contact for more information regarding mounting positions.



- POINT**
Note on selection
- When the stroke is increased, the maximum speed will drop to prevent reaching a critical rotational speed of the ball screw. Please confirm the maximum speed for the desired stroke in the actuator specifications table below.
 - The payload assumes operation at an acceleration of 0.3G (0.2G for lead 5) for horizontal, and 0.2G for vertical use.
 - The payload drops when the acceleration is increased.
 - Please refer to our website for more information about push-motion operation.

Actuator Specifications

Lead and Payload

Model number	Motor (W)	Lead (mm)	Maximum payload		Rated thrust (N)	Stroke (mm)
			Horizontal (kg)	Vertical (kg)		
RCS3-SS8R-①-100-30-②-③-④-⑤	100	30	8	2	56.6	50~1,000 (Every 50mm)
RCS3-SS8R-①-100-20-②-③-④-⑤		20	20	4	84.9	
RCS3-SS8R-①-100-10-②-③-④-⑤		10	40	8	169.8	
RCS3-SS8R-①-100-5-②-③-④-⑤		5	80	16	339.7	
RCS3-SS8R-①-150-30-②-③-④-⑤	150	30	12	3	85.1	
RCS3-SS8R-①-150-20-②-③-④-⑤		20	30	6	127.6	
RCS3-SS8R-①-150-10-②-③-④-⑤		10	60	12	255.3	

Legend: ① Encoder type ② Stroke ③ Applicable controller ④ Cable length ⑤ Options

Stroke and Maximum Speed (Unit: mm/s)

Stroke / Lead	Maximum Speed (mm/s)								
	50-600 (Every 50mm)	650	700	750	800	850	900	950	1,000
30	1,800	1,660	1,460	1,295	1,155	1,035	935	850	775
20	1,200	1,105	970	860	770	690	625	565	515
10	600	550	485	430	385	345	310	280	255
5	300	275	240	215	190	170	150	140	125

① Encoder Type / ② Stroke

Stroke (mm)	Standard price	
	Encoder type	
	Battery-less absolute Motor wattage	
	100W	150W
50/100	-	-
150/200	-	-
250/300	-	-
350/400	-	-
450/500	-	-
550/600	-	-
650/700	-	-
750/800	-	-
850/900	-	-
950/1,000	-	-

④ Cable Length

Type	Cable code	Standard price
Standard type	P (1m)	-
	S (3m)	-
	M (5m)	-
Special length	X06 (6m) ~X10 (10m)	-
	X11 (11m) ~X15 (15m)	-
	X16 (16m) ~X20 (20m)	-
	R01 (1m) ~R03 (3m)	-
Robot cable	R04 (4m) ~R05 (5m)	-
	R06 (6m) ~R10 (10m)	-
	R11 (11m) ~R15 (15m)	-
	R16 (16m) ~R20 (20m)	-

*Please refer to P. 84 for maintenance cables.

⑤ Options

Name	Option code	Reference page	Standard price
Brake	B	-	-
CE marking	CE	-	-
Motor mounted on left, cable exit from back	MLE	Please refer to our website for the details of the options.	-
Motor mounted on left, cable exit from side	MLS		-
Motor mounted on right, cable exit from back	MRE		-
Motor mounted on right, cable exit from side	MRS		-
Non-motor end specification	NM		-
Slider roller specification	SR	-	-

Actuator Specifications

Item	Description
Drive system	Ball screw Ø16mm, rolled C10
Positioning repeatability	±0.02mm
Lost motion	0.1mm or less
Base	Material: Dedicated alloy steel
Static allowable moment	Ma: 198.9N·m, Mb: 198.9N·m, Mc: 416.7N·m
Dynamic allowable moment (*)	Ma: 43.4N·m, Mb: 43.4N·m, Mc: 90.9N·m
Ambient operating temperature, humidity	0 to 40°C, 85% RH or less (Non-condensing)

*Reference for overhang load length/Ma: 450mm or less, Mb, Mc: 450mm or less

(*) Assumes a standard rated life of 10,000km. The operational life will vary depending on operation and installation conditions.

Please refer to our website for more information regarding the service life of the products, directions of the allowable moment, and overhang load length.

Dimensions

CAD drawings can be downloaded from our website. www.intelligentactuator.com



- *1 Connects the motor-encoder cable. Please refer to P.84 for the details of the cables.
- *2 When the slider is returning to its home position, please be careful of interference from surrounding objects, as it will travel until it reaches the ME.
- ME: Mechanical end SE: Stroke end
- * Offset reference position for the allowable moment is the same as the one for SS8C type. (Please refer to P. 40)

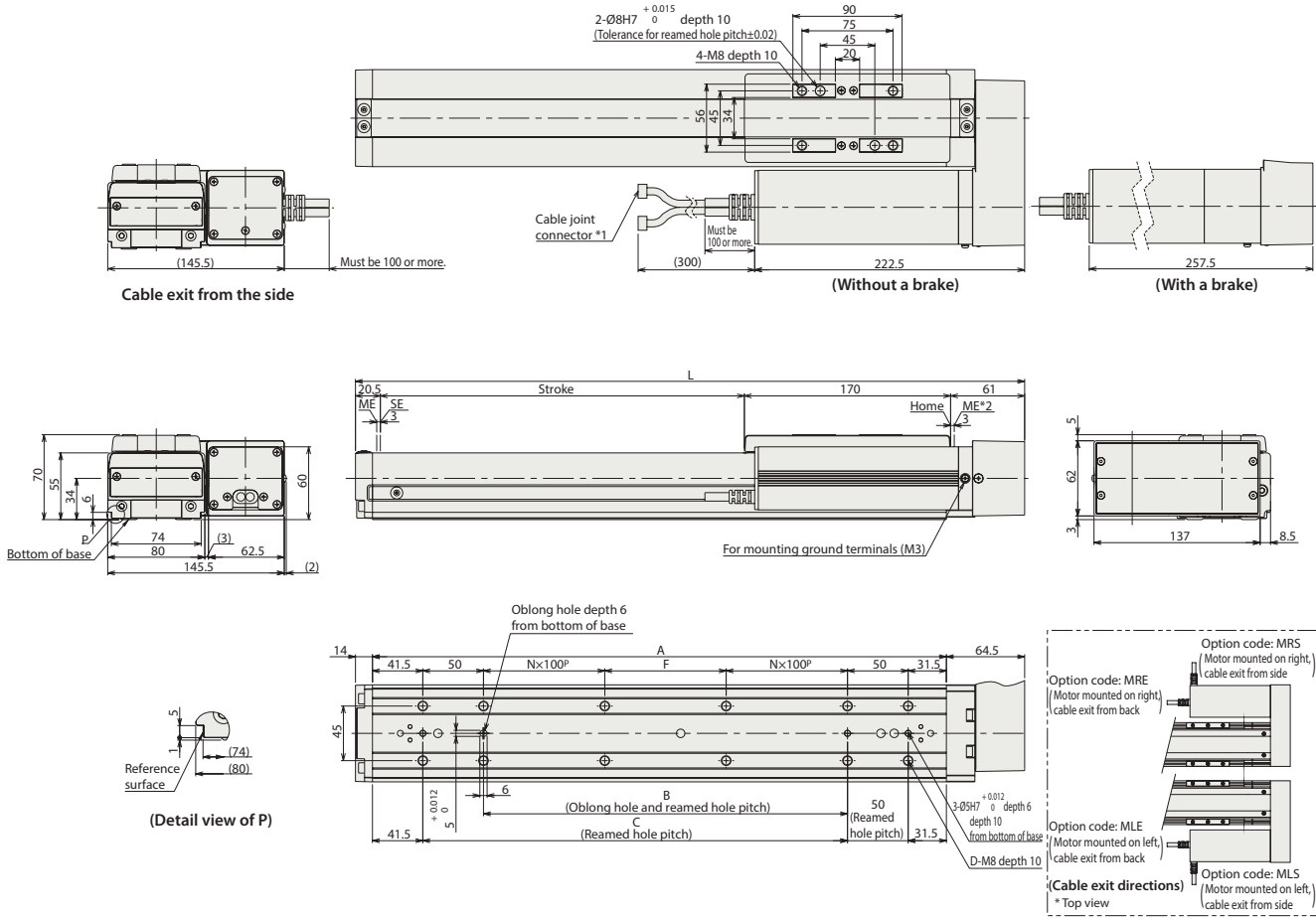

■ Dimensions and Mass by Stroke

Stroke	50	100	150	200	250	300	350	400	450	500	550	600	650	700	750	800	850	900	950	1,000		
L	301.5	351.5	401.5	451.5	501.5	551.5	601.5	651.5	701.5	751.5	801.5	851.5	901.5	951.5	1,001.5	1,051.5	1,101.5	1,151.5	1,201.5	1,251.5		
A	223	273	323	373	423	473	523	573	623	673	723	773	823	873	923	973	1,023	1,073	1,123	1,173		
B	50	100	150	200	250	300	350	400	450	500	550	600	650	700	750	800	850	900	950	1,000		
C	100	150	200	250	300	350	400	450	500	550	600	650	700	750	800	850	900	950	1,000	1,050		
D	8	8	8	10	12	12	12	14	16	16	16	18	20	20	20	22	24	24	24	24	26	
F	50	100	150	0	50	100	150	0	50	100	150	0	50	100	150	0	50	100	150	0		
N	0	0	0	1	1	1	1	2	2	2	3	3	3	3	4	4	4	4	4	5		
Mass (kg)	100W	Without brake	6.0	6.5	7.1	7.6	8.2	8.7	9.3	9.8	10.4	10.9	11.5	12.0	12.6	13.1	13.7	14.2	14.8	15.3	15.9	16.4
		With brake	6.3	6.8	7.4	7.9	8.5	9.0	9.6	10.1	10.7	11.2	11.8	12.3	12.9	13.4	14.0	14.5	15.1	15.6	16.2	16.7
	150W	Without brake	6.1	6.6	7.2	7.7	8.3	8.8	9.4	9.9	10.5	11.0	11.6	12.1	12.7	13.2	13.8	14.3	14.9	15.4	16.0	16.5
		With brake	6.4	6.9	7.5	8.0	8.6	9.1	9.7	10.2	10.8	11.3	11.9	12.4	13.0	13.5	14.1	14.6	15.2	15.7	16.3	16.8

RCACR-SA4C

Cleanroom Type ROBO Cylinder, Slider Type, Actuator Width 40mm, 24V Servo Motor, Coupled Motor, Aluminum Base

Model Specification Items	Series	Type	Encoder type	Motor type	Lead	Stroke	Applicable controller	Cable length	Options
	RCACR	SA4C	WA: Battery-less absolute	20: Servo motor 20W	10: 10mm 5: 5mm 2.5: 2.5mm	50: 50mm 400: 400mm (Can be set in 50mm increments)	A5: ACON-CB	N: No cable P: 1m S: 3m M: 5m X□□: Specified length R□□: Robot cable	Please refer to the options table below.

*Controller is not included.

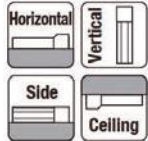

* Depending on the model, there may be some limitations to using the vertical, side, and ceiling mount positions. Please contact for more information regarding mounting positions.

Energy Saving Option



* This product is equipped with a slot for slider position adjustment (refer to the dimensional drawing on the right page) shown as A in the figure above.

- POINT**
Note on selection
- (1) When the stroke is increased, the maximum speed will drop to prevent reaching a critical rotational speed of the ball screw. Please confirm the maximum speed for the desired stroke in the actuator specifications table below.
 - (2) The payload assumes operation at an acceleration of 0.3G (0.2G for lead 2.5). This is the upper limit of the acceleration.
 - (3) Please refer to our website for more information about push-motion operation.

Actuator Specifications

Lead and Payload

Model number	Motor (W)	Lead (mm)	Maximum payload		Rated thrust (N)	Stroke (mm)
			Horizontal (kg)	Vertical (kg)		
RCACR-SA4C-①-20-10-②-③-④-⑤	20	10	4	1	19.6	50~400 (Every 50mm)
RCACR-SA4C-①-20-5-②-③-④-⑤		5	6	2.5	39.2	
RCACR-SA4C-①-20-2.5-②-③-④-⑤		2.5	8	4.5	78.4	

Stroke, Max. Speed and Suction Amount

Stroke Lead	50~400 (Every 50mm)	
	Stroke	Suction amount (NL/min)
10	665	50
5	330	30
2.5	165	15

Legend: ① Encoder type ② Stroke ③ Applicable controller ④ Cable length ⑤ Options

(Unit for max. speed: mm/s)

① Encoder Type / ② Stroke

Stroke (mm)	Standard price	
	Encoder type	Battery-less absolute WA
50	-	-
100	-	-
150	-	-
200	-	-
250	-	-
300	-	-
350	-	-
400	-	-

④ Cable Length

Type	Cable code	Standard price
Standard type	P (1m)	-
	S (3m)	-
	M (5m)	-
Special length	X06 (6m) ~X10 (10m)	-
	X11 (11m) ~X15 (15m)	-
	X16 (16m) ~X20 (20m)	-
Robot cable	R01 (1m) ~R03 (3m)	-
	R04 (4m) ~R05 (5m)	-
	R06 (6m) ~R10 (10m)	-
	R11 (11m) ~R15 (15m)	-
	R16 (16m) ~R20 (20m)	-

*Please refer to P. 73 for maintenance cables.

⑤ Options

Name	Option code	Reference page	Standard price
Brake	B	Please refer to our website for the details of the options.	-
Foot bracket	FT		-
Home check sensor	HS		-
Energy saving	LA		-
Non-motor end specification	NM		-
Slider spacer	SS		-
Vacuum joint on opposite side	VR		-

Actuator Specifications

Item	Description
Drive system	Ball screw Ø8mm, rolled C10
Positioning repeatability	±0.02mm
Lost motion	0.1mm or less
Base	Material: Aluminum with white alumite treatment
Static allowable moment	Ma: 6.90N·m, Mb: 9.90N·m, Mc: 17.0N·m
Dynamic allowable moment (*)	Ma: 3.29N·m, Mb: 4.71N·m, Mc: 8.07N·m
Cleanliness	Class 10 (Fed.Std.209D), Equiv. to Class 2.5 (ISO 14644-1 Standard)
Ambient operating temperature, humidity	0 to 40°C, 85% RH or less (Non-condensing)

*Reference for overhang load length/Ma: 120mm or less, Mb, Mc: 120mm or less
 (*) Assumes a standard rated life of 5,000km. The operational life will vary depending on operation and installation conditions.
 Please refer to our website for more information regarding the service life of the products, directions of the allowable moment, and overhang load length.

Dimensions

CAD drawings can be downloaded from our website, www.intelligentactuator.com



- *1 Connect the motor/encoder cables. Refer in Pg. 73 for details of cables.
- *2 When the slider is returning to its home position, please be careful of interference from surrounding objects, as it will travel until it reaches the ME.
- ME: Mechanical end SE: Stroke end
- *3 Reference position used when calculating the allowable moment.

- *4 When the actuator is mounted only using the mounting holes on the top of the base, the base can be distorted, which could cause sliding error or abnormal noise. When using the mounting holes on the top of the base, please keep the stroke length less than 200mm.

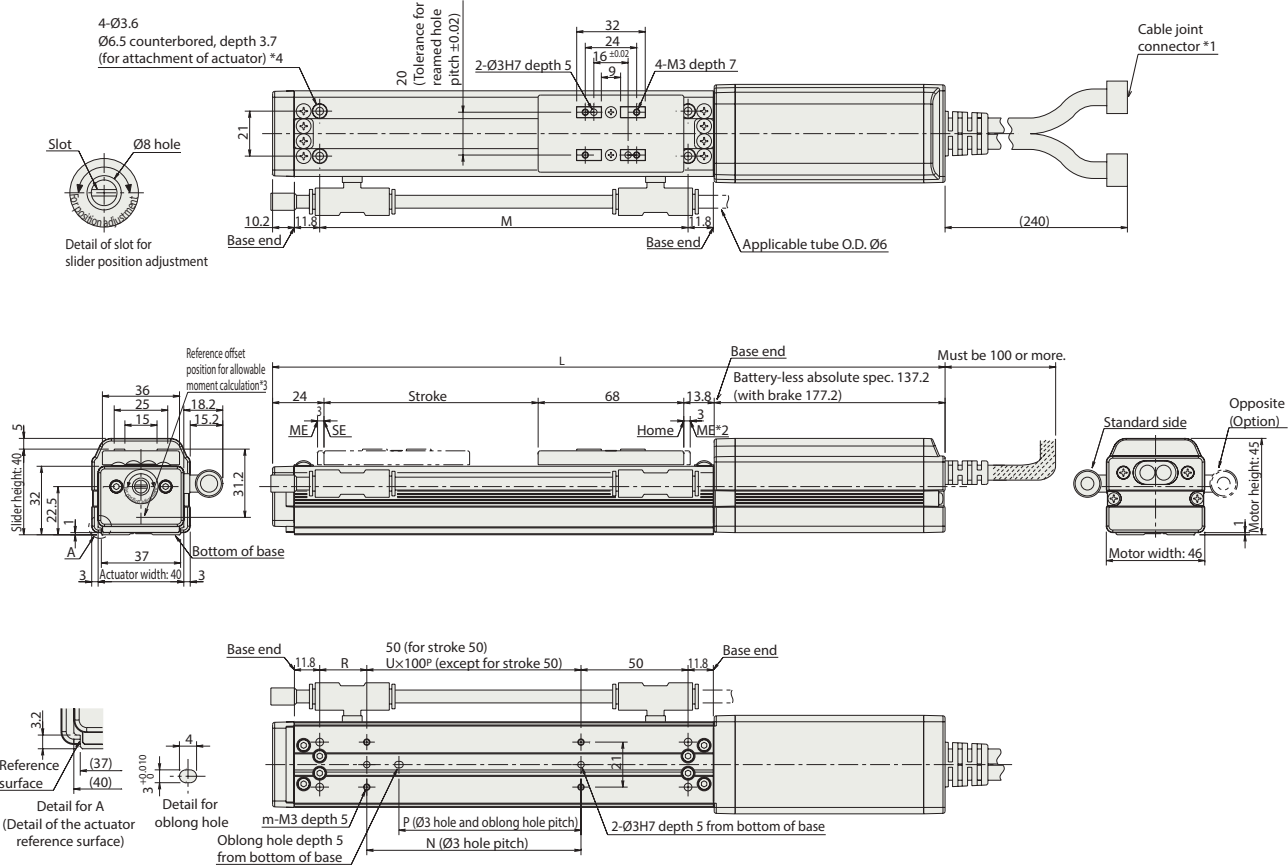

■Dimensions and Mass by Stroke *Brake equipped types are 0.3kg heavier.

L	Stroke		50	100	150	200	250	300	350	400
	Battery-less absolute	Without brake	293	343	393	443	493	543	593	643
		With brake	333	383	433	483	533	583	633	683
	M		122	172	222	272	322	372	422	472
	N		50	100	100	200	200	300	300	400
	P		35	85	85	185	185	285	285	385
	R		22	22	72	22	72	22	72	22
	U		-	1	1	2	2	3	3	4
	m		4	4	4	6	6	8	8	10
	Mass (kg)		0.7	0.8	0.9	1	1.1	1.2	1.3	1.4

RCACR-SA5C

Cleanroom Type ROBO Cylinder, Slider Type, Actuator Width 52mm, 24V Servo Motor, Coupled Motor, Aluminum Base

Model Specification Items	Series	Type	Encoder type	Motor type	Lead	Stroke	Applicable controller	Cable length	Options
	RCACR	SA5C	WA: Battery-less absolute	20: Servo motor 20W	20: 20mm 12: 12mm 6: 6mm 3: 3mm	50: 50mm 1 500: 500mm (Can be set in 50mm increments)	A5: ACON-CB	N: No cable P: 1m S: 3m M: 5m X□□: Specified length R□□: Robot cable	Please refer to the options table below.

*Controller is not included.

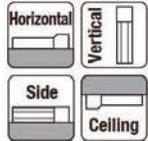

* Depending on the model, there may be some limitations to using the vertical, side, and ceiling mount positions. Please contact for more information regarding mounting positions.

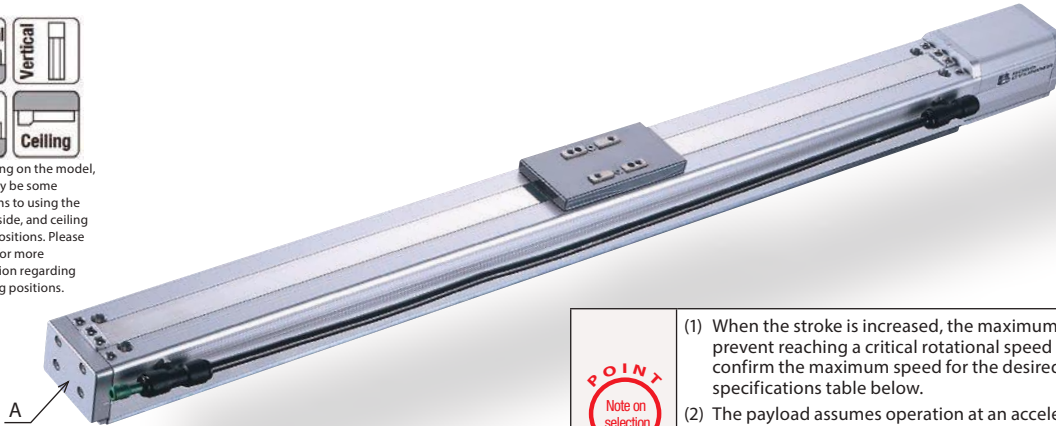

* This product is equipped with a slot for slider position adjustment (refer to the dimensional drawing on the right page) shown as A in the figure above.

Energy Saving Option

- POINT**
Note on selection
- (1) When the stroke is increased, the maximum speed will drop to prevent reaching a critical rotational speed of the ball screw. Please confirm the maximum speed for the desired stroke in the actuator specifications table below.
 - (2) The payload assumes operation at an acceleration of 0.3G (0.2G for lead 3). This is the upper limit of the acceleration.
 - (3) Please refer to our website for more information about push-motion operation.

Actuator Specifications

Lead and Payload

Model number	Motor (W)	Lead (mm)	Maximum payload		Rated thrust (N)	Stroke (mm)
			Horizontal (kg)	Vertical (kg)		
RCACR-SA5C-①-20-20-②-③-④-⑤	20	20	2	0.5	10.7	50~500 (Every 50mm)
RCACR-SA5C-①-20-12-②-③-④-⑤		12	4	1	16.7	
RCACR-SA5C-①-20-6-②-③-④-⑤		6	8	2	33.3	
RCACR-SA5C-①-20-3-②-③-④-⑤		3	12	4	65.7	

Legend: ① Encoder type ② Stroke ③ Applicable controller ④ Cable length ⑤ Options

Stroke, Max. Speed and Suction Amount

Stroke / Lead	50~450 (Every 50mm)	500 (mm)	Suction amount (Nℓ/min)
	20	1,300 <800>	
12	800	760	50
6	400	380	30
3	200	190	15

Values in brackets < > are for vertical use. (Unit for max. speed: mm/s)

① Encoder Type / ② Stroke

Stroke (mm)	Standard price	
	Encoder type	Battery-less absolute
	WA	
50	-	-
100	-	-
150	-	-
200	-	-
250	-	-
300	-	-
350	-	-
400	-	-
450	-	-
500	-	-

④ Cable Length

Type	Cable code	Standard price
Standard type	P (1m)	-
	S (3m)	-
	M (5m)	-
Special length	X06 (6m) ~X10 (10m)	-
	X11 (11m) ~X15 (15m)	-
	X16 (16m) ~X20 (20m)	-
Robot cable	R01 (1m) ~R03 (3m)	-
	R04 (4m) ~R05 (5m)	-
	R06 (6m) ~R10 (10m)	-
	R11 (11m) ~R15 (15m)	-
	R16 (16m) ~R20 (20m)	-

*Please refer to P. 73 for maintenance cables.

⑤ Options

Name	Option code	Reference page	Standard price
Brake	B	Please refer to our website for the details of the options.	-
Foot bracket	FT		-
Home check sensor	HS		-
Energy saving	LA		-
Non-motor end specification	NM		-
Vacuum joint on opposite side	VR		-

Actuator Specifications

Item	Description
Drive system	Ball screw Ø10mm, rolled C10
Positioning repeatability (*1)	±0.02mm [±0.03mm]
Lost motion	0.1mm or less
Base	Material: Aluminum with white alumite treatment
Static allowable moment	Ma: 18.6N·m, Mb: 26.6N·m, Mc: 47.5N·m
Dynamic allowable moment (*2)	Ma: 5.81N·m, Mb: 8.30N·m, Mc: 14.8N·m
Cleanliness	Class 10 (Fed.Std.209D), Equiv. to Class 2.5 (ISO 14644-1 Standard)
Ambient operating temperature, humidity	0 to 40°C, 85% RH or less (Non-condensing)

*Reference for overhang load length/Ma: 150mm or less, Mb, Mc: 150mm or less

(*1) The value in [] applies when the lead is 20mm.

(*2) Assumes a standard rated life of 5,000km. The operational life will vary depending on operation and installation conditions.

Please refer to our website for more information regarding the service life of the products, directions of the allowable moment, and overhang load length.

Dimensions

CAD drawings can be downloaded from our website, www.intelligentactuator.com



*1 Connect the motor/encoder cables. Refer in Pg. 73 for details of cables.

*2 When the slider is returning to its home position, please be careful of interference from surrounding objects, as it will travel until it reaches the ME.

ME: Mechanical end SE: Stroke end

*3 Reference position used when calculating the allowable moment.

*4 When the actuator is mounted only using the mounting holes on the top of the base, the base can be distorted, which could cause sliding error or abnormal noise. When using the mounting holes on the top of the base, please keep the stroke length less than 300mm.

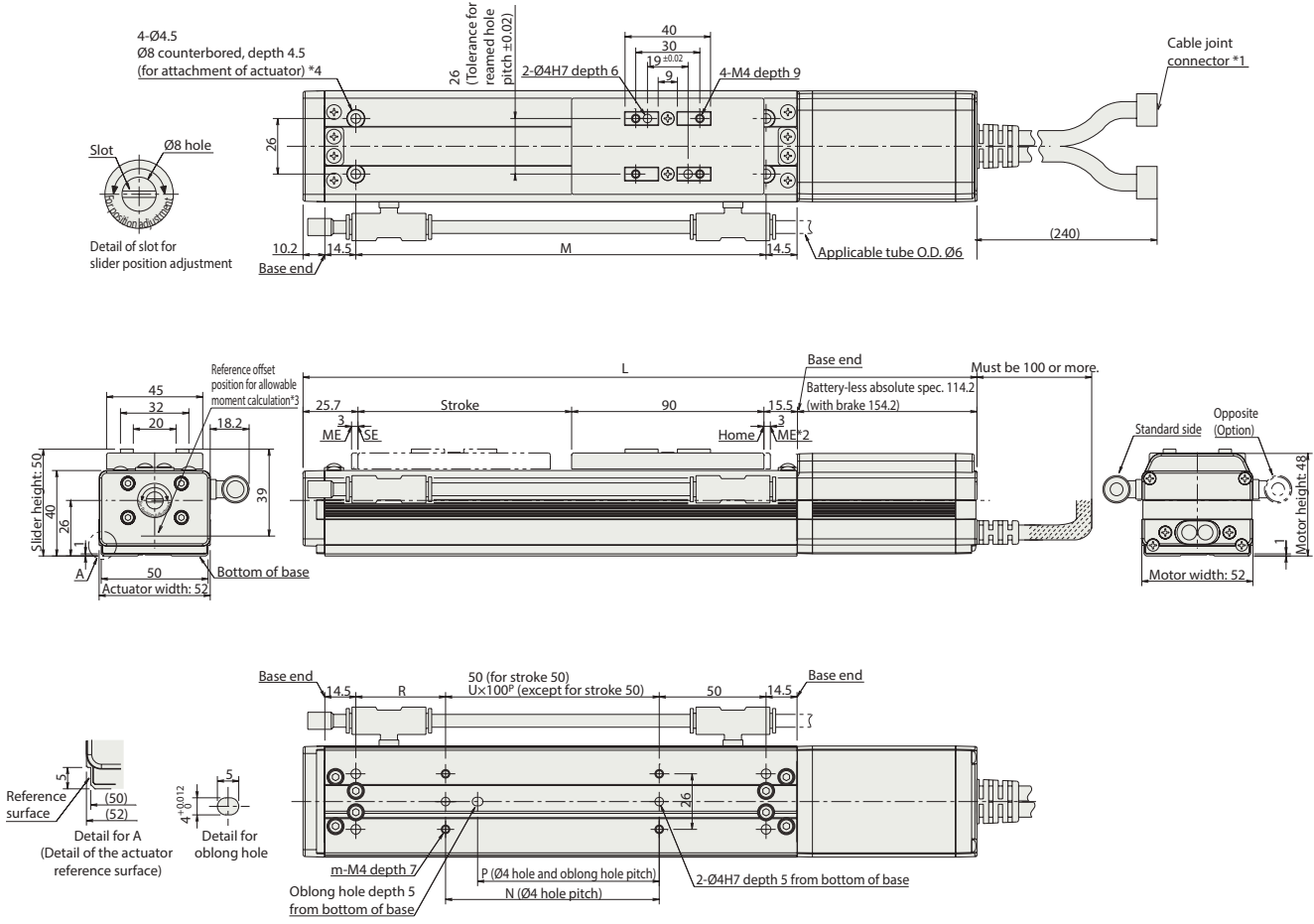

■ Dimensions and Mass by Stroke *Brake equipped types are 0.3kg heavier.

L	Stroke		50	100	150	200	250	300	350	400	450	500
	Battery-less absolute	Without brake	295.4	345.4	395.4	445.4	495.4	545.4	595.4	645.4	695.4	745.4
	With brake	335.4	385.4	435.4	485.4	535.4	585.4	635.4	685.4	735.4	785.4	
M		142	192	242	292	342	392	442	492	542	592	
N		50	100	100	200	200	300	300	400	400	500	
P		35	85	85	185	185	285	285	385	385	485	
R		42	42	92	42	92	42	92	42	92	42	
U		-	1	1	2	2	3	3	4	4	5	
m		4	4	4	6	6	8	8	10	10	12	
	Mass (kg)	1.3	1.4	1.5	1.6	1.7	1.8	1.9	2	2.1	2.2	

RCACR-SA6C

Cleanroom Type ROBO Cylinder, Slider Type, Actuator Width 58mm, 24V Servo Motor, Coupled Motor, Aluminum Base

Model Specification Items	Series	Type	Encoder type	Motor type	Lead	Stroke	Applicable controller	Cable length	Options
	RCACR	SA6C	WA: Battery-less absolute	30: Servo motor 30W	20: 20mm 12: 12mm 6: 6mm 3: 3mm	50: 50mm 600: 600mm (Can be set in 50mm increments)	A5: ACON-CB	N: No cable P: 1m S: 3m M: 5m X□□: Specified length R□□: Robot cable	Please refer to the options table below.

*Controller is not included.



Energy Saving Option

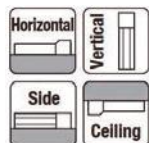

* Depending on the model, there may be some limitations to using the vertical, side, and ceiling mount positions. Please contact for more information regarding mounting positions.



* This product is equipped with a slot for slider position adjustment (refer to the dimensional drawing on the right page) shown as A in the figure above.

- POINT**
Note on selection
- When the stroke is increased, the maximum speed will drop to prevent reaching a critical rotational speed of the ball screw. Please confirm the maximum speed for the desired stroke in the actuator specifications table below.
 - The payload assumes operation at an acceleration of 0.3G (0.2G for lead 3). This is the upper limit of the acceleration.
 - Please refer to our website for more information about push-motion operation.

Actuator Specifications

Lead and Payload

Model number	Motor (W)	Lead (mm)	Maximum payload		Rated thrust (N)	Stroke (mm)
			Horizontal (kg)	Vertical (kg)		
RCACR-SA6C-①-30-20-②-③-④-⑤	30	20	3	0.5	15.8	50~600 (Every 50mm)
RCACR-SA6C-①-30-12-②-③-④-⑤		12	6	1.5	24.2	
RCACR-SA6C-①-30-6-②-③-④-⑤		6	12	3	48.4	
RCACR-SA6C-①-30-3-②-③-④-⑤		3	18	6	96.8	

Legend: ① Encoder type ② Stroke ③ Applicable controller ④ Cable length ⑤ Options

Stroke, Max. Speed and Suction Amount

Stroke / Lead	50~450	500	550	600	Suction amount (N/L/min)
	(Every 50mm)	(mm)	(mm)	(mm)	
20	1,300 <800>	1,160 <800>	990 <800>	80	
12	800	760	640	50	
6	400	380	320	30	
3	200	190	160	15	

Values in brackets < > are for vertical use. (Unit for max. speed: mm/s)

① Encoder Type / ② Stroke

Stroke (mm)	Standard price	
	Encoder type	
	Battery-less absolute	
	WA	
50	-	-
100	-	-
150	-	-
200	-	-
250	-	-
300	-	-
350	-	-
400	-	-
450	-	-
500	-	-
550	-	-
600	-	-

⑤ Options

Name	Option code	Reference page	Standard price
Brake	B	Please refer to our website for the details of the options.	-
Foot bracket	FT		-
Home check sensor	HS		-
Energy saving	LA		-
Non-motor end specification	NM		-
Vacuum joint on opposite side	VR		-

④ Cable Length

Type	Cable code	Standard price
Standard type	P (1m)	-
	S (3m)	-
	M (5m)	-
Special length	X06 (6m) ~ X10 (10m)	-
	X11 (11m) ~ X15 (15m)	-
	X16 (16m) ~ X20 (20m)	-
Robot cable	R01 (1m) ~ R03 (3m)	-
	R04 (4m) ~ R05 (5m)	-
	R06 (6m) ~ R10 (10m)	-
	R11 (11m) ~ R15 (15m)	-
	R16 (16m) ~ R20 (20m)	-

*Please refer to P. 73 for maintenance cables.

Actuator Specifications

Item	Description
Drive system	Ball screw Ø10mm, rolled C10
Positioning repeatability (*1)	±0.02mm [±0.03mm]
Lost motion	0.1mm or less
Base	Material: Aluminum with white alumite treatment
Static allowable moment	Ma: 38.3N·m, Mb: 54.7N·m, Mc: 81.0N·m
Dynamic allowable moment (*2)	Ma: 11.6N·m, Mb: 16.6N·m, Mc: 24.6N·m
Cleanliness	Class 10 (Fed.Std.209D), Equiv. to Class 2.5 (ISO 14644-1 Standard)
Ambient operating temperature, humidity	0 to 40°C, 85% RH or less (Non-condensing)

*Reference for overhang load length/Ma: 220mm or less, Mb, Mc: 220mm or less

(*1) The value in [] applies when the lead is 20mm.

(*2) Assumes a standard rated life of 5,000km. The operational life will vary depending on operation and installation conditions.

Please refer to our website for more information regarding the service life of the products, directions of the allowable moment, and overhang load length.

Dimensions

CAD drawings can be downloaded from our website, www.intelligentactuator.com



- *1 Connect the motor/encoder cables. Refer in Pg. 73 for details of cables.
- *2 When the slider is returning to its home position, please be careful of interference from surrounding objects, as it will travel until it reaches the ME.
- ME: Mechanical end SE: Stroke end
- *3 Reference position used when calculating the allowable moment.

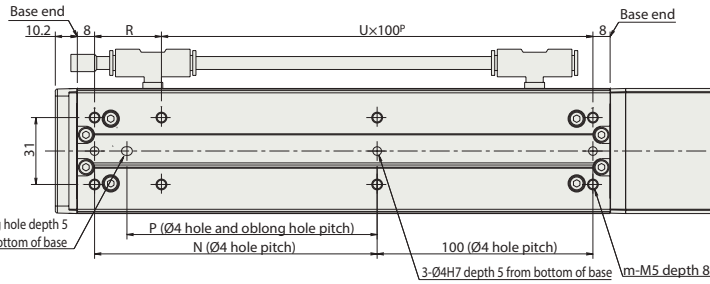
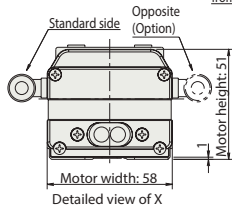
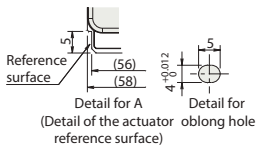
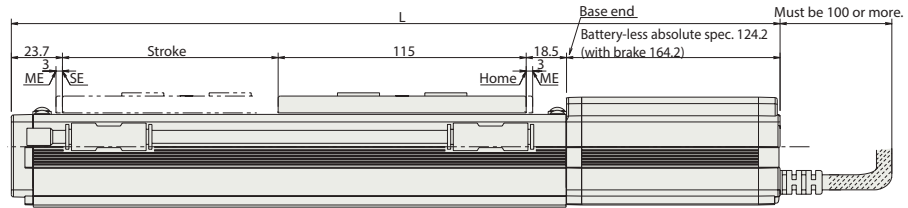
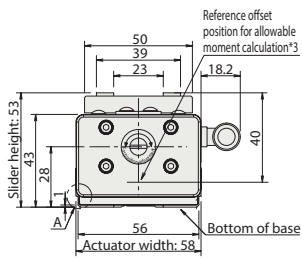
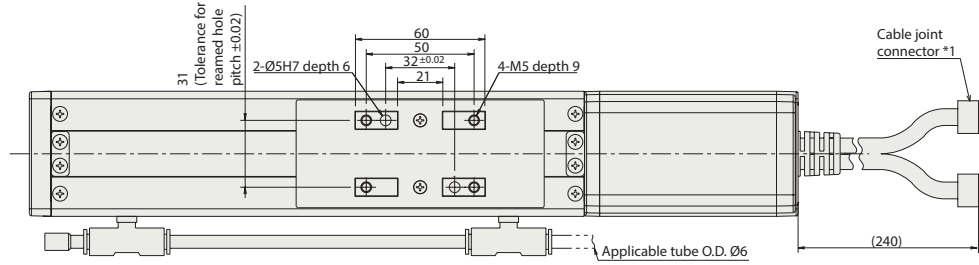
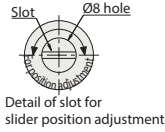

■Dimensions and Mass by Stroke *Brake equipped types are 0.3kg heavier.

Stroke		50	100	150	200	250	300	350	400	450	500	550	600
L	Battery-less absolute	331.4	381.4	431.4	481.4	531.4	581.4	631.4	681.4	731.4	781.4	831.4	881.4
	With brake	371.4	421.4	471.4	521.4	571.4	621.4	671.4	721.4	771.4	821.4	871.4	921.4
N		81	131	181	231	281	331	381	431	481	531	581	631
P		66	116	166	216	266	316	366	416	466	516	566	616
R		81	31	81	31	81	31	81	31	81	31	81	31
U		1	2	2	3	3	4	4	5	5	6	6	7
m		6	8	8	10	10	12	12	14	14	16	16	18
Mass (kg)		1.4	1.6	1.8	2	2.2	2.4	2.6	2.8	3	3.2	3.4	3.6

RCS2CR-SA4C

Cleanroom Type ROBO Cylinder, Slider Type, Actuator Width 40mm, 200V Servo Motor, Coupled Motor, Aluminum Base

Model Specification Items	RCS2CR — SA4C — <input type="checkbox"/> — 20 — <input type="checkbox"/> — <input type="checkbox"/> — <input type="checkbox"/> — <input type="checkbox"/>
	Series — Type — Encoder type — Motor type — Lead — Stroke — Applicable controller — Cable length — Options
	WA : Battery-less absolute 20 : Servo motor 20W 10 : 10mm 5 : 5mm 2.5 : 2.5mm 50 : 50mm 400 : 400mm (Can be set in 50mm increments) T2 : SCON-CB N : No cable P : 1m S : 3m M : 5m X <input type="checkbox"/> : Specified length R <input type="checkbox"/> : Robot cable Please refer to the options table below.

*Controller is not included.



* CE marking is an option.

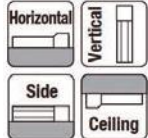

* Depending on the model, there may be some limitations to using the vertical, side, and ceiling mount positions. Please contact for more information regarding mounting positions.

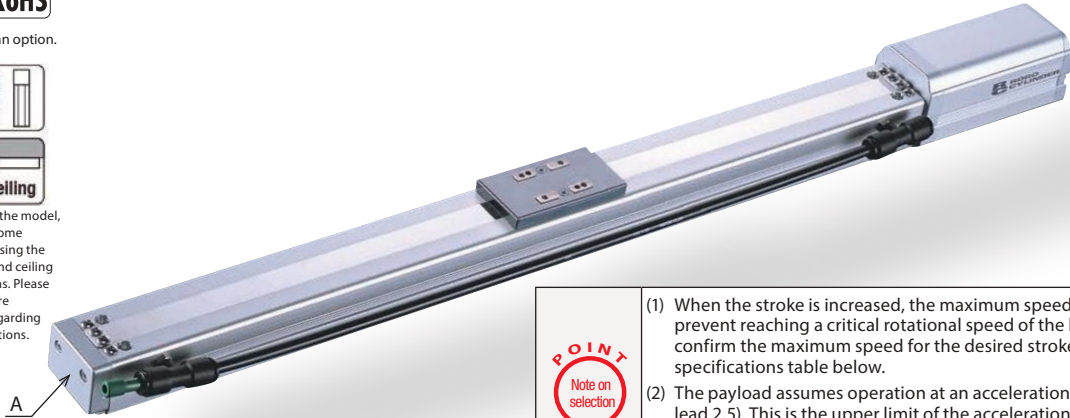

* This product is equipped with a slot for slider position adjustment (refer to the dimensional drawing on the right page) shown as A in the figure above.

- POINT**
Note on selection
- (1) When the stroke is increased, the maximum speed will drop to prevent reaching a critical rotational speed of the ball screw. Please confirm the maximum speed for the desired stroke in the actuator specifications table below.
 - (2) The payload assumes operation at an acceleration of 0.3G (0.2G for lead 2.5). This is the upper limit of the acceleration.
 - (3) Please refer to our website for more information about push-motion operation.

Actuator Specifications

Lead and Payload

Model number	Motor (W)	Lead (mm)	Maximum payload		Rated thrust (N)	Stroke (mm)
			Horizontal (kg)	Vertical (kg)		
RCS2CR-SA4C-①-20-10-②-③-④-⑤	20	10	4	1	19.6	50~400 (Every 50mm)
RCS2CR-SA4C-①-20-5-②-③-④-⑤		5	6	2.5	39.2	
RCS2CR-SA4C-①-20-2.5-②-③-④-⑤		2.5	8	4.5	78.4	

Legend: ① Encoder type ② Stroke ③ Applicable controller ④ Cable length ⑤ Options

Stroke, Max. Speed and Suction Amount

Stroke / Lead	50~400 (Every 50mm)	Suction amount (Nℓ/min)
5	330	30
2.5	165	15

(Unit for max. speed: mm/s)

① Encoder Type / ② Stroke

Stroke (mm)	Standard price	
	Encoder type	
	Battery-less absolute	
	WA	
50	-	-
100	-	-
150	-	-
200	-	-
250	-	-
300	-	-
350	-	-
400	-	-

④ Cable Length

Type	Cable code	Standard price
Standard type	P (1m)	-
	S (3m)	-
	M (5m)	-
Special length	X06 (6m) ~ X10 (10m)	-
	X11 (11m) ~ X15 (15m)	-
	X16 (16m) ~ X20 (20m)	-
Robot cable	R01 (1m) ~ R03 (3m)	-
	R04 (4m) ~ R05 (5m)	-
	R06 (6m) ~ R10 (10m)	-
	R11 (11m) ~ R15 (15m)	-
	R16 (16m) ~ R20 (20m)	-

*Please refer to P. 84 for maintenance cables.

⑤ Options

Name	Option code	Reference page	Standard price
Brake	B	Please refer to our website for the details of the options.	-
CE marking	CE		-
Foot bracket	FT		-
Home check sensor	HS		-
Non-motor end specification	NM		-
Slider spacer	SS		-
Vacuum joint on opposite side	VR		-

Actuator Specifications

Item	Description
Drive system	Ball screw Ø8mm, rolled C10
Positioning repeatability	±0.02mm
Lost motion	0.1mm or less
Base	Material: Aluminum with white alumite treatment
Static allowable moment	Ma: 6.90N·m, Mb: 9.90N·m, Mc: 17.0N·m
Dynamic allowable moment (*)	Ma: 3.29N·m, Mb: 4.71N·m, Mc: 8.07N·m
Cleanliness	Class 10 (Fed.Std.209D), Equiv. to Class 2.5 (ISO 14644-1 Standard)
Ambient operating temperature, humidity	0 to 40°C, 85% RH or less (Non-condensing)

*Reference for overhang load length/Ma: 120mm or less, Mb, Mc: 120mm or less

(*) Assumes a standard rated life of 5,000km. The operational life will vary depending on operation and installation conditions.

Please refer to our website for more information regarding the service life of the products, directions of the allowable moment, and overhang load length.

Dimensions

CAD drawings can be downloaded from our website, www.intelligentactuator.com



- *1 Connects the motor-encoder cable. Please refer to P.84 for the details of the cables.
- *2 When the slider is returning to its home position, please be careful of interference from surrounding objects, as it will travel until it reaches the ME.
- ME: Mechanical end SE: Stroke end
- *3 Reference position used when calculating the allowable moment.
- *4 When the actuator is mounted only using the mounting holes on the top of the base, the base can be distorted, which could cause sliding error or abnormal noise. When using the mounting holes on the top of the base, please keep the stroke length less than 200mm.

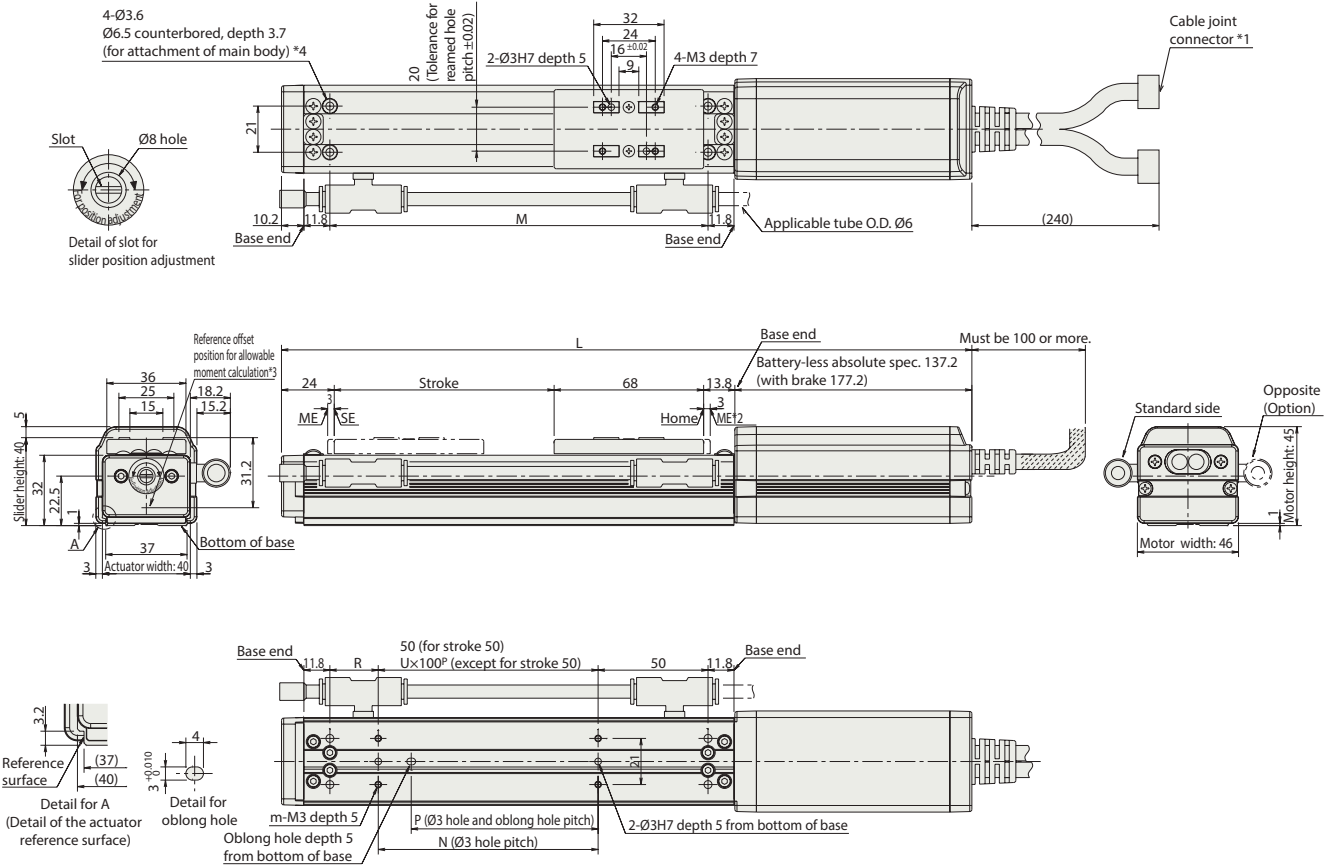

Dimensions and Mass by Stroke *Brake equipped types are 0.3kg heavier.

Stroke	Stroke								
	50	100	150	200	250	300	350	400	
L	Battery-less	293	343	393	443	493	543	593	643
	absolute	333	383	433	483	533	583	633	683
	M	122	172	222	272	322	372	422	472
	N	50	100	100	200	200	300	300	400
	P	35	85	85	185	185	285	285	385
	R	22	22	72	22	72	22	72	22
	U	-	1	1	2	2	3	3	4
	m	4	4	4	6	6	8	8	10
	Mass (kg)	0.7	0.8	0.9	1	1.1	1.2	1.3	1.4

RCS2CR-SA5C

Cleanroom Type ROBO Cylinder, Slider Type, Actuator Width 52mm, 200V Servo Motor, Coupled Motor, Aluminum Base

Model Specification Items	RCS2CR	SA5C	<input type="checkbox"/>	20	<input type="checkbox"/>	<input type="checkbox"/>	<input type="checkbox"/>	<input type="checkbox"/>	<input type="checkbox"/>
	Series	Type	Encoder type	Motor type	Lead	Stroke	Applicable controller	Cable length	Options
			WA: Battery-less absolute	20: Servo motor 20W	20: 20mm 12: 12mm 6: 6mm 3: 3mm	50: 50mm 1: 500: 500mm (Can be set in 50mm increments)	T2: SCON-CB	N: No cable P: 1m S: 3m M: 5m X <input type="checkbox"/> : Specified length R <input type="checkbox"/> : Robot cable	Please refer to the options table below.

*Controller is not included.



* CE marking is an option.

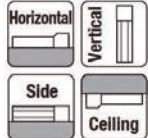

* Depending on the model, there may be some limitations to using the vertical, side, and ceiling mount positions. Please contact for more information regarding mounting positions.



* This product is equipped with a slot for slider position adjustment (refer to the dimensional drawing on the right page) shown as A in the figure above.

POINT
Note on selection

- (1) When the stroke is increased, the maximum speed will drop to prevent reaching a critical rotational speed of the ball screw. Please confirm the maximum speed for the desired stroke in the actuator specifications table below.
- (2) The payload assumes operation at an acceleration of 0.3G (0.2G for lead 3). This is the upper limit of the acceleration.
- (3) Please refer to our website for more information about push-motion operation.

Actuator Specifications

Lead and Payload

Model number	Motor (W)	Lead (mm)	Maximum payload		Rated thrust (N)	Stroke (mm)
			Horizontal (kg)	Vertical (kg)		
RCS2CR-SA5C-①-20-20-②-③-④-⑤	20	20	2	0.5	10.7	50~500 (Every 50mm)
RCS2CR-SA5C-①-20-12-②-③-④-⑤		12	4	1	16.7	
RCS2CR-SA5C-①-20-6-②-③-④-⑤		6	8	2	33.3	
RCS2CR-SA5C-①-20-3-②-③-④-⑤		3	12	4	65.7	

Legend: ① Encoder type ② Stroke ③ Applicable controller ④ Cable length ⑤ Options

Stroke, Max. Speed and Suction Amount

Stroke / Lead	50~450 (Every 50mm)	500 (mm)	Suction amount (Nℓ/min)
	20	1,300 <800>	
12	800	760	50
6	400	380	30
3	200	190	15

Values in brackets < > are for vertical use. (Unit for max. speed: mm/s)

① Encoder Type / ② Stroke

Stroke (mm)	Standard price	
	Encoder type	
	Battery-less absolute	
	WA	
50	-	-
100	-	-
150	-	-
200	-	-
250	-	-
300	-	-
350	-	-
400	-	-
450	-	-
500	-	-

④ Cable Length

Type	Cable code	Standard price
Standard type	P (1m)	-
	S (3m)	-
	M (5m)	-
Special length	X06 (6m) ~X10 (10m)	-
	X11 (11m) ~X15 (15m)	-
	X16 (16m) ~X20 (20m)	-
Robot cable	R01 (1m) ~R03 (3m)	-
	R04 (4m) ~R05 (5m)	-
	R06 (6m) ~R10 (10m)	-
	R11 (11m) ~R15 (15m)	-
	R16 (16m) ~R20 (20m)	-

*Please refer to P. 84 for maintenance cables.

⑤ Options

Name	Option code	Reference page	Standard price
Brake	B	Please refer to our website for the details of the options.	-
CE marking	CE		-
Foot bracket	FT		-
Home check sensor	HS		-
Non-motor end specification	NM		-
Vacuum joint on opposite side	VR		-

Actuator Specifications

Item	Description
Drive system	Ball screw Ø10mm, rolled C10
Positioning repeatability	±0.02mm
Lost motion	0.1mm or less
Base	Material: Aluminum with white alumite treatment
Static allowable moment	Ma: 18.6N·m, Mb: 26.6N·m, Mc: 47.5N·m
Dynamic allowable moment (*)	Ma: 5.81N·m, Mb: 8.30N·m, Mc: 14.8N·m
Cleanliness	Class 10 (Fed.Std.209D), Equiv. to Class 2.5 (ISO 14644-1 Standard)
Ambient operating temperature, humidity	0 to 40°C, 85% RH or less (Non-condensing)

*Reference for overhang load length/Ma: 150mm or less, Mb, Mc: 150mm or less
 (*) Assumes a standard rated life of 5,000km. The operational life will vary depending on operation and installation conditions.
 Please refer to our website for more information regarding the service life of the products, directions of the allowable moment, and overhang load length.

Dimensions

CAD drawings can be downloaded from our website, www.intelligentactuator.com



- *1 Connects the motor-encoder cable. Please refer to P.84 for the details of the cables.
- *2 When the slider is returning to its home position, please be careful of interference from surrounding objects, as it will travel until it reaches the ME.
- ME: Mechanical end SE: Stroke end
- *3 Reference position used when calculating the allowable moment.
- *4 When the actuator is mounted only using the mounting holes on the top of the base, the base can be distorted, which could cause sliding error or abnormal noise. When using the mounting holes on the top of the base, please keep the stroke length less than 300mm.

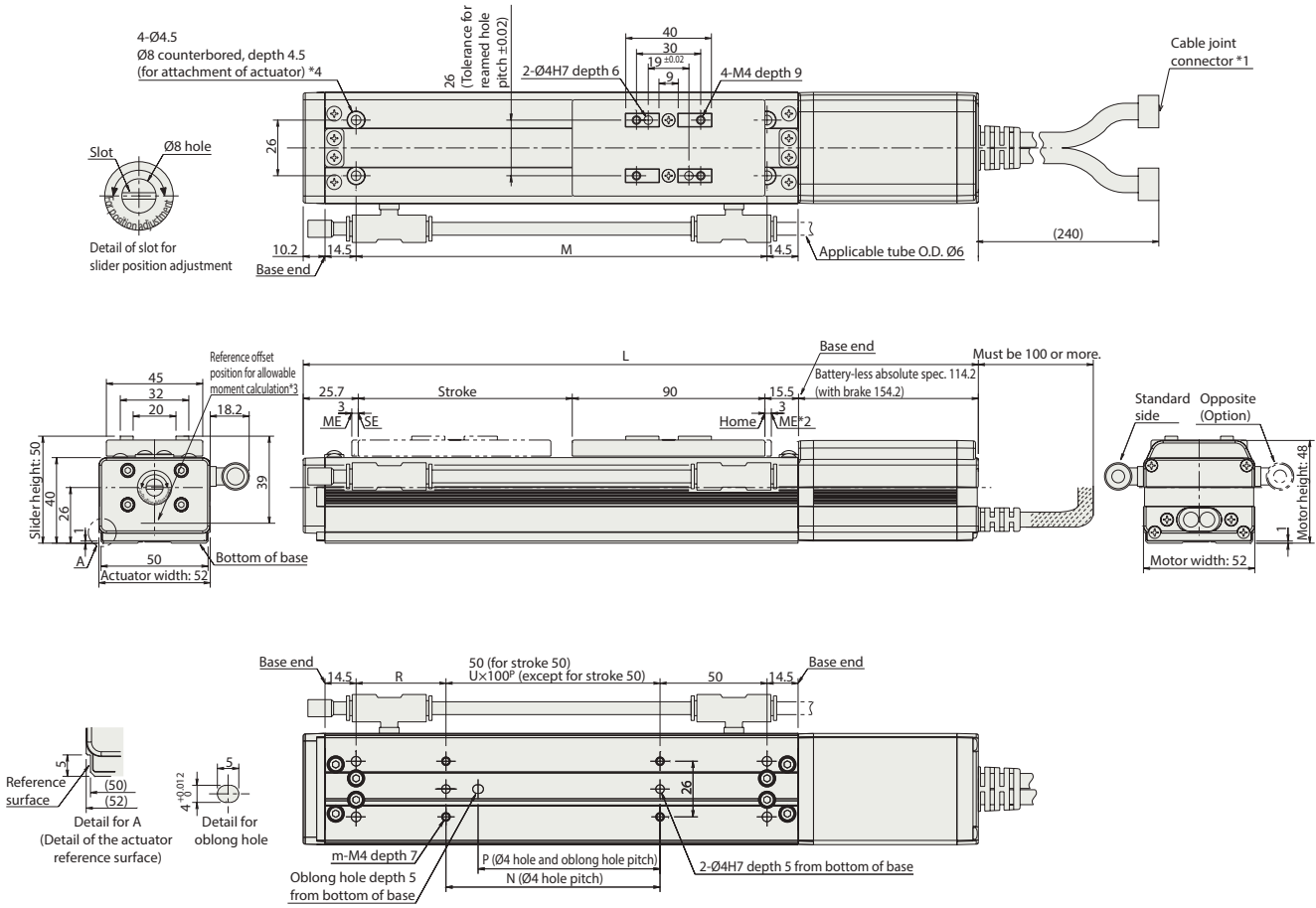

■ Dimensions and Mass by Stroke *Brake equipped types are 0.3kg heavier.

L	Stroke		50	100	150	200	250	300	350	400	450	500
	Battery-less absolute	Without brake	295.4	345.4	395.4	445.4	495.4	545.4	595.4	645.4	695.4	745.4
		With brake	335.4	385.4	435.4	485.4	535.4	585.4	635.4	685.4	735.4	785.4
	M		142	192	242	292	342	392	442	492	542	592
	N		50	100	100	200	200	300	300	400	400	500
	P		35	85	85	185	185	285	285	385	385	485
	R		42	42	92	42	92	42	92	42	92	42
	U		-	1	1	2	2	3	3	4	4	5
	m		4	4	4	6	6	8	8	10	10	12
	Mass (kg)		1.3	1.4	1.5	1.6	1.7	1.8	1.9	2	2.1	2.2

RCS2CR-SA6C

Cleanroom Type ROBO Cylinder, Slider Type, Actuator Width 58mm, 200V Servo Motor, Coupled Motor, Aluminum Base

Model Specification Items	RCS2CR	SA6C	<input type="checkbox"/>	30	<input type="checkbox"/>	<input type="checkbox"/>	<input type="checkbox"/>	<input type="checkbox"/>	<input type="checkbox"/>
	Series	Type	Encoder type	Motor type	Lead	Stroke	Applicable controller	Cable length	Options
			WA: Battery-less absolute	30: Servo motor 30W	20: 20mm 12: 12mm 6: 6mm 3: 3mm	50: 50mm 600: 600mm (Can be set in 50mm increments)	T2: SCON-CB	N: No cable P: 1m S: 3m M: 5m X <input type="checkbox"/> : Specified length R <input type="checkbox"/> : Robot cable	Please refer to the options table below.

*Controller is not included.



* CE marking is an option.

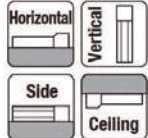

* Depending on the model, there may be some limitations to using the vertical, side, and ceiling mount positions. Please contact for more information regarding mounting positions.



* This product is equipped with a slot for slider position adjustment (refer to the dimensional drawing on the right page) shown as A in the figure above.

POINT
Note on selection

- (1) When the stroke is increased, the maximum speed will drop to prevent reaching a critical rotational speed of the ball screw. Please confirm the maximum speed for the desired stroke in the actuator specifications table below.
- (2) The payload assumes operation at an acceleration of 0.3G (0.2G for lead 3). This is the upper limit of the acceleration.
- (3) Please refer to our website for more information about push-motion operation.

Actuator Specifications

Lead and Payload

Model number	Motor (W)	Lead (mm)	Maximum payload		Rated thrust (N)	Stroke (mm)
			Horizontal (kg)	Vertical (kg)		
RCS2CR-SA6C-①-30-20-②-③-④-⑤	30	20	3	0.5	15.8	50~600 (Every 50mm)
RCS2CR-SA6C-①-30-12-②-③-④-⑤		12	6	1.5	24.2	
RCS2CR-SA6C-①-30-6-②-③-④-⑤		6	12	3	48.4	
RCS2CR-SA6C-①-30-3-②-③-④-⑤		3	18	6	96.8	

Legend: ① Encoder type ② Stroke ③ Applicable controller ④ Cable length ⑤ Options

Stroke, Max. Speed and Suction Amount

Stroke / Lead	50~450	500	550	600	Suction amount (NL/min)
	(Every 50mm)	(mm)	(mm)	(mm)	
20	1,300 <800>	1,160 <800>	990 <800>	80	
12	800	760	640	540	50
6	400	380	320	270	30
3	200	190	160	135	15

Values in brackets < > are for vertical use. (Unit for max. speed: mm/s)

① Encoder Type / ② Stroke

Stroke (mm)	Standard price	
	Encoder type	
	Battery-less absolute	
	WA	
50	-	-
100	-	-
150	-	-
200	-	-
250	-	-
300	-	-
350	-	-
400	-	-
450	-	-
500	-	-
550	-	-
600	-	-

⑤ Options

Name	Option code	Reference page	Standard price
Brake	B	Please refer to our website for the details of the options.	-
CE marking	CE		-
Foot bracket	FT		-
Home check sensor	HS		-
Non-motor end specification	NM		-
Vacuum joint on opposite side	VR		-

④ Cable Length

Type	Cable code	Standard price
Standard type	P (1m)	-
	S (3m)	-
	M (5m)	-
Special length	X06 (6m) ~ X10 (10m)	-
	X11 (11m) ~ X15 (15m)	-
	X16 (16m) ~ X20 (20m)	-
Robot cable	R01 (1m) ~ R03 (3m)	-
	R04 (4m) ~ R05 (5m)	-
	R06 (6m) ~ R10 (10m)	-
	R11 (11m) ~ R15 (15m)	-
	R16 (16m) ~ R20 (20m)	-

*Please refer to P. 84 for maintenance cables.

Actuator Specifications

Item	Description
Drive system	Ball screw Ø10mm, rolled C10
Positioning repeatability	±0.02mm
Lost motion	0.1mm or less
Base	Material: Aluminum with white alumite treatment
Static allowable moment	Ma: 38.3N·m, Mb: 54.7N·m, Mc: 81.0N·m
Dynamic allowable moment (*)	Ma: 11.6N·m, Mb: 16.6N·m, Mc: 24.6N·m
Cleanliness	Class 10 (Fed.Std.209D), Equiv. to Class 2.5 (ISO 14644-1 Standard)
Ambient operating temperature, humidity	0 to 40°C, 85% RH or less (Non-condensing)

*Reference for overhang load length/Ma: 220mm or less, Mb, Mc: 220mm or less
(*) Assumes a standard rated life of 5,000km. The operational life will vary depending on operation and installation conditions.

Please refer to our website for more information regarding the service life of the products, directions of the allowable moment, and overhang load length.

Dimensions

CAD drawings can be downloaded from our website, www.intelligentactuator.com



- *1 Connects the motor-encoder cable. Please refer to P.84 for the details of the cables.
- *2 When the slider is returning to its home position, please be careful of interference from surrounding objects, as it will travel until it reaches the ME.
- ME: Mechanical end SE: Stroke end
- *3 Reference position used when calculating the allowable moment.

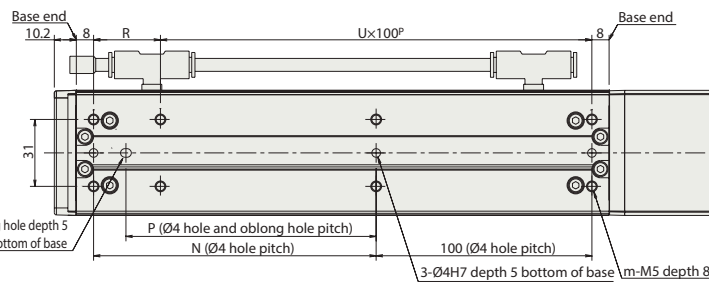
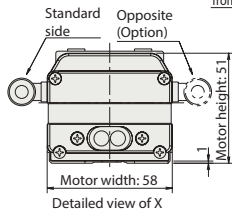
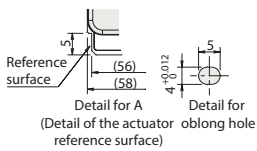
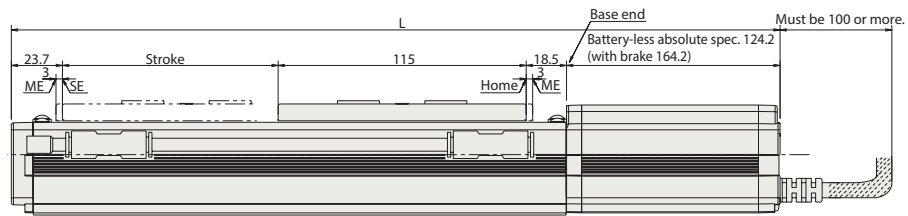
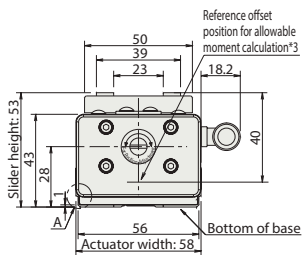
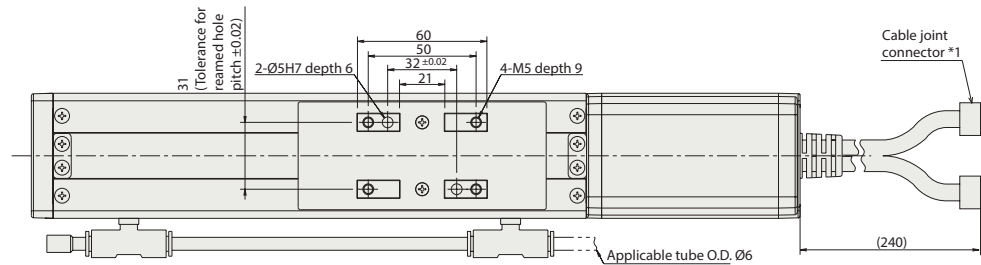
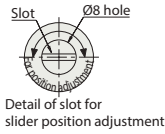

■ Dimensions and Mass by Stroke *Brake equipped types are 0.3kg heavier.

L	Stroke		50	100	150	200	250	300	350	400	450	500	550	600
	Battery-less absolute	Without brake	331.4	381.4	431.4	481.4	531.4	581.4	631.4	681.4	731.4	781.4	831.4	881.4
		With brake	371.4	421.4	471.4	521.4	571.4	621.4	671.4	721.4	771.4	821.4	871.4	921.4
	N		81	131	181	231	281	331	381	431	481	531	581	631
	P		66	116	166	216	266	316	366	416	466	516	566	616
	R		81	31	81	31	81	31	81	31	81	31	81	31
	U		1	2	2	3	3	4	4	5	5	6	6	7
	m		6	8	8	10	10	12	12	14	14	16	16	18
	Mass (kg)		1.4	1.6	1.8	2	2.2	2.4	2.6	2.8	3	3.2	3.4	3.6

RCS2CR-SA7C

Cleanroom Type ROBO Cylinder, Slider Type, Actuator Width 73mm, 200V Servo Motor, Coupled Motor, Aluminum Base

Model Specification Items	RCS2CR	SA7C	<input type="checkbox"/>	60	<input type="checkbox"/>	<input type="checkbox"/>	<input type="checkbox"/>	<input type="checkbox"/>	<input type="checkbox"/>
	Series	Type	Encoder type	Motor type	Lead	Stroke	Applicable controller	Cable length	Options
			WA: Battery-less absolute	60: Servo motor 60W	16: 16mm 8: 8mm 4: 4mm	50: 50mm 800: 800mm (Can be set in 50mm increments)	T2: SCON-CB	N: No cable P: 1m S: 3m M: 5m X <input type="checkbox"/> : Specified length R <input type="checkbox"/> : Robot cable	Please refer to the options table below.

*Controller is not included.



* CE marking is an option.

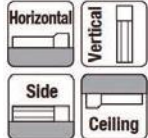

* Depending on the model, there may be some limitations to using the vertical, side, and ceiling mount positions. Please contact for more information regarding mounting positions.

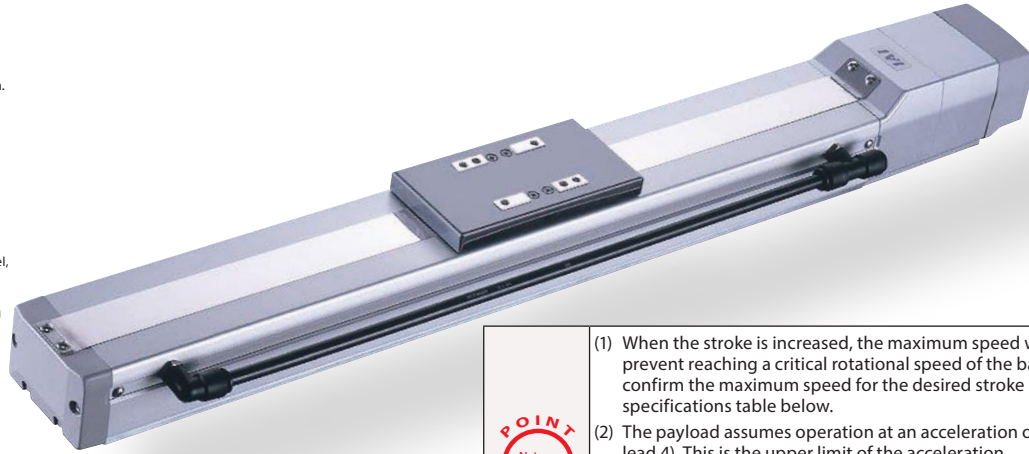

- POINT**
Note on selection
- When the stroke is increased, the maximum speed will drop to prevent reaching a critical rotational speed of the ball screw. Please confirm the maximum speed for the desired stroke in the actuator specifications table below.
 - The payload assumes operation at an acceleration of 0.3G (0.2G for lead 4). This is the upper limit of the acceleration.
 - The product complies with Cleanliness Class 10 when it is used in horizontal orientation. It may not be able to comply with Class 10 in side or vertical orientations.
 - Please refer to our website for more information about push-motion operation.

Actuator Specifications

Lead and Payload

Model number	Motor (W)	Lead (mm)	Maximum payload		Rated thrust (N)	Stroke (mm)
			Horizontal (kg)	Vertical (kg)		
RCS2CR-SA7C-①-60-16-②-③-④-⑤	60	16	12	3	63.8	50~800 (Every 50mm)
RCS2CR-SA7C-①-60-8-②-③-④-⑤		8	25	6	127.5	
RCS2CR-SA7C-①-60-4-②-③-④-⑤		4	40	12	255.0	

Legend: ① Encoder type ② Stroke ③ Applicable controller ④ Cable length ⑤ Options

Stroke, Max. Speed and Suction Amount

Stroke / Lead	50~600	~700	~800	Suction amount (Nℓ/min)
	(Every 50mm)	(mm)	(mm)	
16	800	640	480	50
8	400	320	240	30
4	200	160	120	10

(Unit for max. speed: mm/s)

① Encoder Type / ② Stroke

Stroke (mm)	Standard price	
	Encoder type	
	Battery-less absolute	
	WA	
50/100	-	
150/200	-	
250/300	-	
350/400	-	
450/500	-	
550/600	-	
650/700	-	
750/800	-	

④ Cable Length

Type	Cable code	Standard price
Standard type	P (1m)	-
	S (3m)	-
	M (5m)	-
Special length	X06 (6m) ~ X10 (10m)	-
	X11 (11m) ~ X15 (15m)	-
	X16 (16m) ~ X20 (20m)	-
Robot cable	R01 (1m) ~ R03 (3m)	-
	R04 (4m) ~ R05 (5m)	-
	R06 (6m) ~ R10 (10m)	-
	R11 (11m) ~ R15 (15m)	-
	R16 (16m) ~ R20 (20m)	-

*Please refer to P. 84 for maintenance cables.

⑤ Options

Name	Option code	Reference page	Standard price
Brake (Cable exit to end)	BE	Please refer to our website for the details of the options.	-
Brake (Cable exit to left side)	BL		-
Brake (Cable exit to right side)	BR		-
CE marking	CE		-
Non-motor end specification	NM		-
Vacuum joint on opposite side	VR	-	

Actuator Specifications

Item	Description
Drive system	Ball screw Ø12mm, rolled C10
Positioning repeatability	±0.02mm
Lost motion	0.1mm or less
Base	Material: Aluminum with white alumite treatment
Static allowable moment	Ma: 50.4N·m, Mb: 71.9N·m, Mc: 138.0N·m
Dynamic allowable moment (*)	Ma: 20.7N·m, Mb: 29.6N·m, Mc: 56.7N·m
Cleanliness	Class 10 (Fed.Std.209D), Equiv. to Class 2.5 (ISO 14644-1 Standard)
Ambient operating temperature, humidity	0 to 40°C, 85% RH or less (Non-condensing)

*Reference for overhang load length/Ma: 230mm or less, Mb, Mc: 230mm or less
 (*) Assumes a standard rated life of 5,000km. The operational life will vary depending on operation and installation conditions.
 Please refer to our website for more information regarding the service life of the products, directions of the allowable moment, and overhang load length.

Dimensions

CAD drawings can be downloaded from our website. www.intelligentactuator.com

2D CAD

3D CAD

*If the non-motor end (NM) specification is selected, the dimension on the motor side (the distance to the home from ME) and that on the front side are reversed.

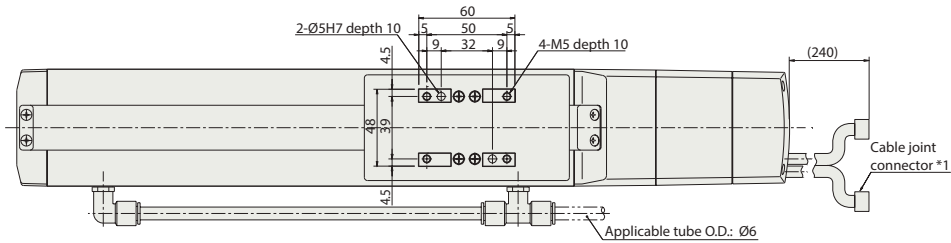

Reference offset position for allowable moment calculation*3

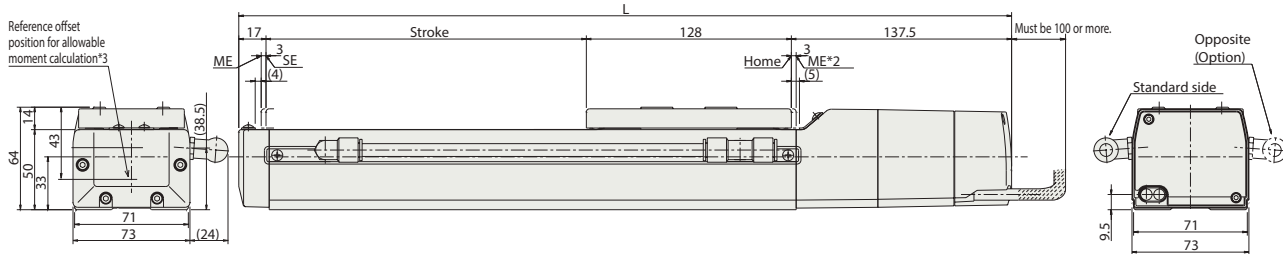

F-Ø6 through, Ø9.5 counterbored, depth 5.5 (from opposite side)

Bx100° E-Ø4H7 depth 6 from bottom of base

Detail for oblong hole

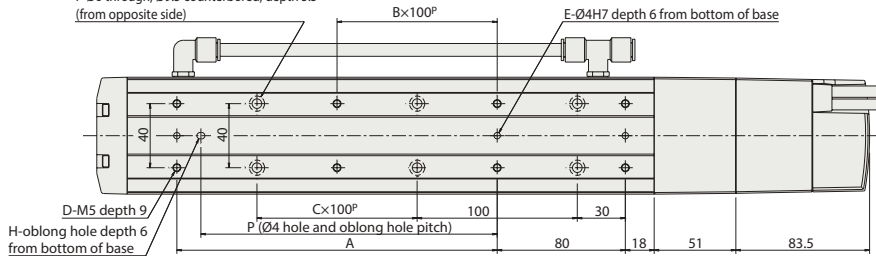

Dimensions for the brake part

* Brake equipped types are 43mm longer (56.3mm longer for cable exit from side) and 0.6kg heavier.

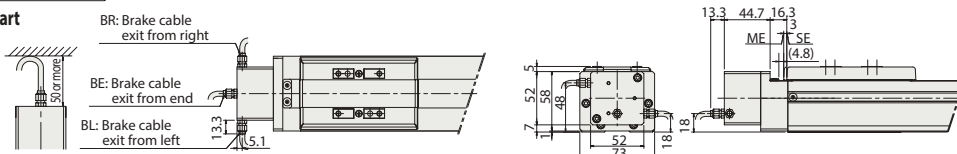

*1 Connects the motor-encoder cable. Please refer to P. 84 for the details of the cables.

*2 When the slider is returning to its home position, please be careful of interference from surrounding objects, as it will travel until it reaches the ME.

ME: Mechanical end SE: Stroke end The dimensions in brackets () are reference.

*3 Reference position used when calculating the allowable moment.

■ Dimensions and Mass by Stroke

Stroke	50	100	150	200	250	300	350	400	450	500	550	600	650	700	750	800
L	332.5	382.5	432.5	482.5	532.5	582.5	632.5	682.5	732.5	782.5	832.5	882.5	932.5	982.5	1,032.5	1,082.5
A	0	100	100	200	200	300	300	400	400	500	500	600	600	700	700	800
B	0	0	0	1	1	2	2	3	3	4	4	5	5	6	6	7
C	0	0	1	1	2	2	3	3	4	4	5	5	6	6	7	7
D	4	6	6	8	8	10	10	12	12	14	14	16	16	18	18	20
E	2	3	3	3	3	3	3	3	3	3	3	3	3	3	3	3
F	4	4	6	6	8	8	10	10	12	12	14	14	16	16	18	18
H	0	1	1	1	1	1	1	1	1	1	1	1	1	1	1	1
P	0	85	85	185	185	285	285	385	385	485	485	585	585	685	685	785
Mass (kg)	2.6	2.8	3.0	3.2	3.5	3.7	3.9	4.1	4.4	4.6	4.8	5.0	5.3	5.5	5.7	5.9

RCS3CR-SA8C

Cleanroom Type ROBO Cylinder, Slider Type, Actuator Width 80mm, 200V Servo Motor, Coupled Motor, Aluminum Base

Model Specification Items	RCS3CR	SA8C							
	Series	Type	Encoder type	Motor type	Lead	Stroke	Applicable controller	Cable length	Options
			WA: Battery-less absolute	100: Servo motor 100W 150: Servo motor 150W	30: 30mm 20: 20mm 10: 10mm 5: 5mm	50: 50mm 1100: 1,100mm (Can be set in 50mm increments)	T2: SCON-CB	N: No cable P: 1m S: 3m M: 5m X□□: Specified length R□□: Robot cable	Please refer to the options table below. * Please specify a code indicating your desired cable exit direction.

*Controller is not included.



* CE marking is an option.

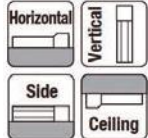

* Depending on the model, there may be some limitations to using the vertical, side, and ceiling mount positions. Please contact for more information regarding mounting positions.

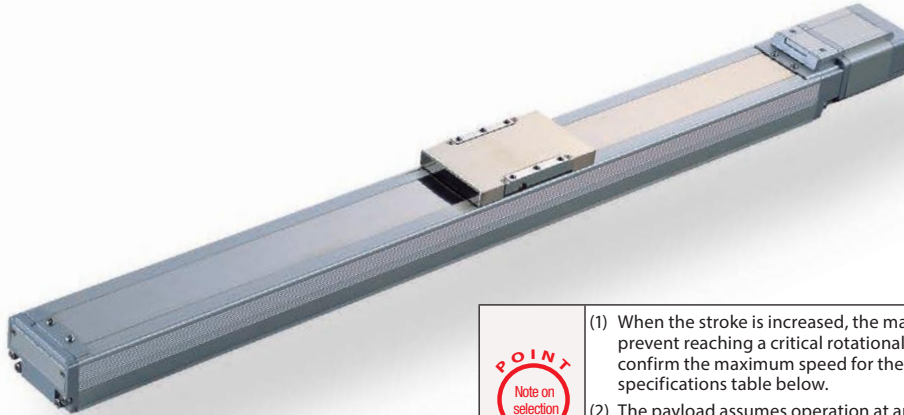

- POINT**
Note on selection
- (1) When the stroke is increased, the maximum speed will drop to prevent reaching a critical rotational speed of the ball screw. Please confirm the maximum speed for the desired stroke in the actuator specifications table below.
 - (2) The payload assumes operation at an acceleration of 0.3G (0.2G for lead 5) for horizontal, and 0.2G for vertical use.
 - (3) The payload drops when the acceleration is increased.

Actuator Specifications

Lead and Payload

Model number	Motor (W)	Lead (mm)	Maximum payload		Rated thrust (N)	Stroke (mm)
			Horizontal (kg)	Vertical (kg)		
RCS3CR-SA8C-①-100-30-②-③-④-⑤	100	30	8	2	56.6	50~1,100 (Every 50mm)
RCS3CR-SA8C-①-100-20-②-③-④-⑤		20	20	4	84.9	
RCS3CR-SA8C-①-100-10-②-③-④-⑤		10	40	8	169.8	
RCS3CR-SA8C-①-100-5-②-③-④-⑤		5	80	16	339.7	
RCS3CR-SA8C-①-150-30-②-③-④-⑤	150	30	12	3	85.1	
RCS3CR-SA8C-①-150-20-②-③-④-⑤		20	30	6	127.6	
RCS3CR-SA8C-①-150-10-②-③-④-⑤		10	60	12	255.3	

Legend: ① Encoder type ② Stroke ③ Applicable controller ④ Cable length ⑤ Options

Stroke, Max. Speed and Suction Amount

Stroke / Lead	Stroke (mm)										Suction amount (Nℓ/min)
	50-650 (Every 30mm)	700	750	800	850	900	950	1,000	1,050	1,100	
30	1,800	1,510	1,340	1,190	1,070	960	870	790	720	660	130 (160) (*)
20	1,200	1,010	890	790	710	640	580	530	480	440	110
10	600	500	440	390	350	320	290	260	240	220	60
5	300	250	220	190	170	160	140	130	120	110	30

(Unit for max. speed: mm/s)

(*) 130Nℓ/min if the speed is 1,500mm/s or below, or 160Nℓ/min if the speed exceeds 1,500mm/s.

① Encoder Type / ② Stroke

Stroke (mm)	Standard price	
	100W	150W
50/100	-	-
150/200	-	-
250/300	-	-
350/400	-	-
450/500	-	-
550/600	-	-
650/700	-	-
750/800	-	-
850/900	-	-
950/1,000	-	-
1,050/1,100	-	-

④ Cable Length

Type	Cable code	Standard price
Standard type	P (1m)	-
	S (3m)	-
	M (5m)	-
Special length	X06 (6m) ~X10 (10m)	-
	X11 (11m) ~X15 (15m)	-
	X16 (16m) ~X20 (20m)	-
Robot cable	R01 (1m) ~R03 (3m)	-
	R04 (4m) ~R05 (5m)	-
	R06 (6m) ~R10 (10m)	-
	R11 (11m) ~R15 (15m)	-
	R16 (16m) ~R20 (20m)	-

*Please refer to P. 84 for maintenance cables.

⑤ Options

Name	Option code	Reference page	Standard price
Cables exit from back left	A1E	Please refer to our website for the details of the options.	-
Cables exit from left side	A1S		-
Cables exit from back right	A3E		-
Cables exit from right side	A3S		-
Brake	B		-
CE marking	CE		-
Non-motor end specification	NM		-
L-shaped suction joint specification	VL		-
No suction joint	VN		-

Actuator Specifications

Item	Description
Drive system	Ball screw Ø16mm, rolled C10
Positioning repeatability	±0.02mm
Lost motion	0.1mm or less
Base	Material: Aluminum with white alumite treatment
Static allowable moment	Ma: 113.5N·m, Mb: 177N·m, Mc: 266N·m
Dynamic allowable moment (*)	Ma: 26.9N·m, Mb: 38.4N·m, Mc: 63.1N·m
Cleanliness	Class 10 (Fed.Std.209D), Equiv. to Class 2.5 (ISO 14644-1 Standard)
Ambient operating temperature, humidity	0 to 40°C, 85% RH or less (Non-condensing)

*Reference for overhang load length/Ma: 390mm or less, Mb, Mc: 390mm or less
(*) Assumes a standard rated life of 10,000km. The operational life will vary depending on operation and installation conditions.

Please refer to our website for more information regarding the service life of the products, directions of the allowable moment, and overhang load length.

Dimensions

CAD drawings can be downloaded from our website, www.intelligentactuator.com



- *1 Connects the motor-encoder cable. Please refer to P. 84 for the details of the cables.
- *2 When the slider is returning to its home position, please be careful of interference from surrounding objects, as it will travel until it reaches the ME.
- ME: Mechanical end SE: Stroke end
- *3 Reference position used when calculating the allowable moment.

(L-shaped suction joint specification)

*The suction joint is placed on the opposite side of where the cable exits.

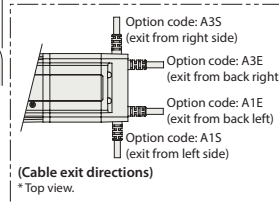
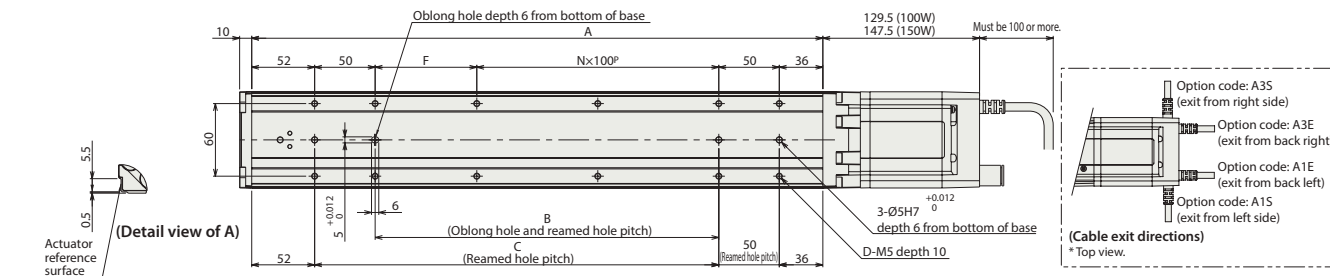
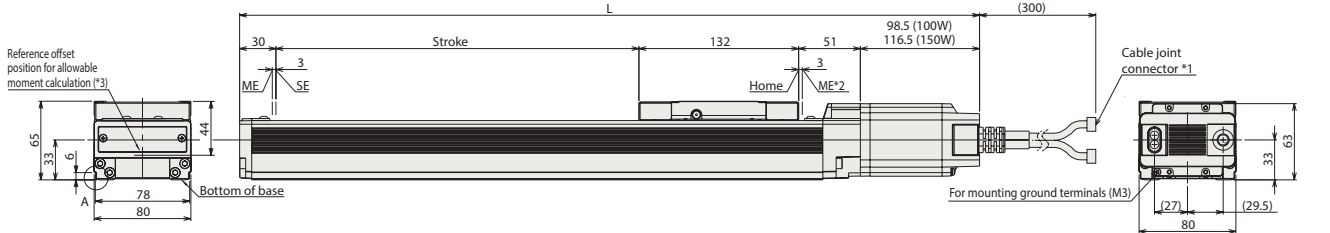
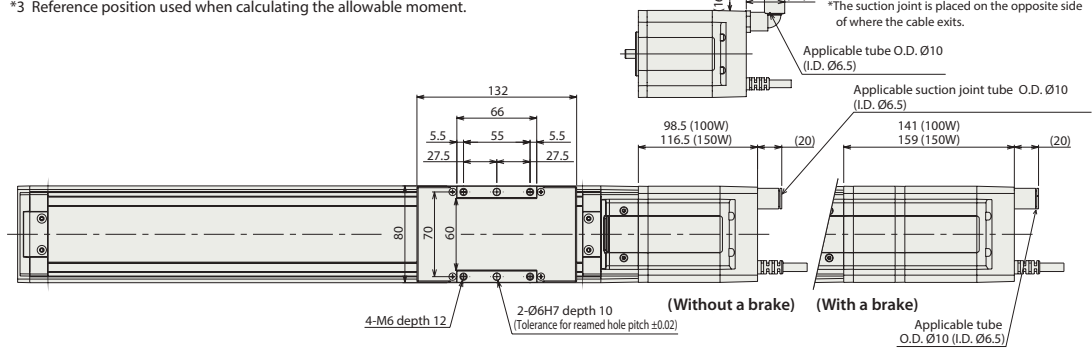

■ Dimensions and Mass by Stroke

L	Stroke	50	100	150	200	250	300	350	400	450	500	550	600	650	700	750	800	850	900	950	1,000	1,050	1,100	
		100W	Without brake	361.5	411.5	461.5	511.5	561.5	611.5	661.5	711.5	761.5	811.5	861.5	911.5	961.5	1,011.5	1,061.5	1,111.5	1,161.5	1,211.5	1,261.5	1,311.5	1,361.5
	With brake	404	454	504	554	604	654	704	754	804	854	904	954	1,004	1,054	1,104	1,154	1,204	1,254	1,304	1,354	1,404	1,454	
150W	Without brake	379.5	429.5	479.5	529.5	579.5	629.5	679.5	729.5	779.5	829.5	879.5	929.5	979.5	1,029.5	1,079.5	1,129.5	1,179.5	1,229.5	1,279.5	1,329.5	1,379.5	1,429.5	
	With brake	422	472	522	572	622	672	722	772	822	872	922	972	1,022	1,072	1,122	1,172	1,222	1,272	1,322	1,372	1,422	1,472	
A		222	272	322	372	422	472	522	572	622	672	722	772	822	872	922	972	1,022	1,072	1,122	1,172	1,222	1,272	
B		34	84	134	184	234	284	334	384	434	484	534	584	634	684	734	784	834	884	934	984	1,034	1,084	
C		84	134	184	234	284	334	384	434	484	534	584	634	684	734	784	834	884	934	984	1,034	1,084	1,134	
D		8	8	10	10	12	12	14	14	16	16	18	18	20	20	22	22	24	24	26	26	28	28	
F		34	84	34	84	34	84	34	84	34	84	34	84	34	84	34	84	34	84	34	84	34	84	
N		0	0	1	1	2	2	3	3	4	4	5	5	6	6	7	7	8	8	9	9	10	10	
Mass (kg)	100W	Without brake	2.8	3.1	3.4	3.7	4.0	4.3	4.6	4.9	5.2	5.5	5.8	6.1	6.4	6.7	7.0	7.3	7.6	7.9	8.2	8.5	8.8	9.1
		With brake	3.2	3.5	3.8	4.1	4.4	4.7	5.0	5.3	5.6	5.9	6.2	6.5	6.8	7.1	7.4	7.7	8.0	8.3	8.6	8.9	9.2	9.5
	150W	Without brake	2.9	3.2	3.5	3.8	4.1	4.4	4.7	5.0	5.3	5.6	5.9	6.2	6.5	6.8	7.1	7.4	7.7	8.0	8.3	8.6	8.9	9.2
		With brake	3.4	3.7	4.0	4.3	4.6	4.9	5.2	5.5	5.8	6.1	6.4	6.7	7.0	7.3	7.6	7.9	8.2	8.5	8.8	9.1	9.4	9.7

RCS3CR-SS8C

Cleanroom Type ROBO Cylinder, Slider Type, Actuator Width 80mm, 200V Servo Motor, Coupled Motor, Steel Base

Model Specification Items	RCS3CR — SS8C	Encoder type	Motor type	Lead	Stroke	Applicable controller	Cable length	Options
	Series — Type	WA: Battery-less absolute	100: Servo motor 100W 150: Servo motor 150W	30: 30mm 20: 20mm 10: 10mm 5: 5mm	50: 50mm 1000: 1,000mm (Can be set in 50mm increments)	T2: SCON-CB	N: No cable P: 1m S: 3m M: 5m X□□: Specified length R□□: Robot cable	Please refer to the options table below. * Please specify a code indicating your desired cable exit direction.

*Controller is not included.



* CE marking is an option.

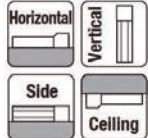

* Depending on the model, there may be some limitations to using the vertical, side, and ceiling mount positions. Please contact for more information regarding mounting positions.



- POINT**
Note on selection
- (1) When the stroke is increased, the maximum speed will drop to prevent reaching a critical rotational speed of the ball screw. Please confirm the maximum speed for the desired stroke in the actuator specifications table below.
 - (2) The payload assumes operation at an acceleration of 0.3G (0.2G for lead 5) for horizontal, and 0.2G for vertical use.
 - (3) The payload drops when the acceleration is increased.

Actuator Specifications

Lead and Payload

Model number	Motor (W)	Lead (mm)	Maximum payload		Rated thrust (N)	Stroke (mm)
			Horizontal (kg)	Vertical (kg)		
RCS3CR-SS8C-①-100-30-②-③-④-⑤	100	30	8	2	56.6	50~1,000 (Every 50mm)
RCS3CR-SS8C-①-100-20-②-③-④-⑤		20	20	4	84.9	
RCS3CR-SS8C-①-100-10-②-③-④-⑤		10	40	8	169.8	
RCS3CR-SS8C-①-100-5-②-③-④-⑤		5	80	16	339.7	
RCS3CR-SS8C-①-150-30-②-③-④-⑤	150	30	12	3	85.1	
RCS3CR-SS8C-①-150-20-②-③-④-⑤		20	30	6	127.6	
RCS3CR-SS8C-①-150-10-②-③-④-⑤		10	60	12	255.3	

Legend: ① Encoder type ② Stroke ③ Applicable controller ④ Cable length ⑤ Options

Stroke, Max. Speed and Suction Amount

Stroke / Lead	Stroke (mm)										Suction amount (NE/min)
	50~600 (Every 50mm)	650	700	750	800	850	900	950	1,000	1,000	
30	1,800	1,660	1,460	1,295	1,155	1,035	935	850	775	160 (190) (*)	
20	1,200	1,105	970	860	770	690	625	565	515	120	
10	600	550	485	430	385	345	310	280	255	80	
5	300	275	240	215	190	170	150	140	125	30	

(Unit for max. speed: mm/s)

(*) 160NE/min if the speed is 1,500mm/s or below, or 190NE/min if the speed exceeds 1,500mm/s.

① Encoder Type / ② Stroke

Stroke (mm)	Standard price	
	Encoder type	
	Battery-less absolute	
	Motor wattage	
	100W	150W
50/100	-	-
150/200	-	-
250/300	-	-
350/400	-	-
450/500	-	-
550/600	-	-
650/700	-	-
750/800	-	-
850/900	-	-
950/1,000	-	-

④ Cable Length

Type	Cable code	Standard price
Standard type	P (1m)	-
	S (3m)	-
	M (5m)	-
Special length	X06 (6m) ~X10 (10m)	-
	X11 (11m) ~X15 (15m)	-
	X16 (16m) ~X20 (20m)	-
Robot cable	R01 (1m) ~R03 (3m)	-
	R04 (4m) ~R05 (5m)	-
	R06 (6m) ~R10 (10m)	-
	R11 (11m) ~R15 (15m)	-
	R16 (16m) ~R20 (20m)	-

*Please refer to P. 84 for maintenance cables.

⑤ Options

Name	Option code	Reference page	Standard price
Cables exit from back left	A1E	Please refer to our website for the details of the options.	-
Cables exit from left side	A1S		-
Cables exit from back right	A3E		-
Cables exit from right side	A3S		-
Brake	B		-
CE marking	CE		-
Non-motor end specification	NM	-	
L-shaped suction joint specification	VL	-	

Actuator Specifications

Item	Description
Drive system	Ball screw \varnothing 16mm, rolled C10
Positioning repeatability	\pm 0.02mm
Lost motion	0.1mm or less
Base	Material: Dedicated alloy steel
Static allowable moment	Ma: 198.9N·m, Mb: 198.9N·m, Mc: 416.7N·m
Dynamic allowable moment (*)	Ma: 43.4N·m, Mb: 43.4N·m, Mc: 90.9N·m
Cleanliness	Class 10 (Fed.Std.209D), Equiv. to Class 2.5 (ISO 14644-1 Standard)
Ambient operating temperature, humidity	0 to 40°C, 85% RH or less (Non-condensing)

*Reference for overhang load length/Ma: 450mm or less, Mb, Mc: 450mm or less
(*) Assumes a standard rated life of 10,000km. The operational life will vary depending on operation and installation conditions.

Please refer to our website for more information regarding the service life of the products, directions of the allowable moment, and overhang load length.

Dimensions

CAD drawings can be downloaded from our website, www.intelligentactuator.com



- *1 Connects the motor-encoder cable. Please refer to P.84 for the details of the cables.
- *2 When the slider is returning to its home position, please be careful of interference from surrounding objects, as it will travel until it reaches the ME.
- ME: Mechanical end SE: Stroke end
- *3 Reference position used when calculating the allowable moment.

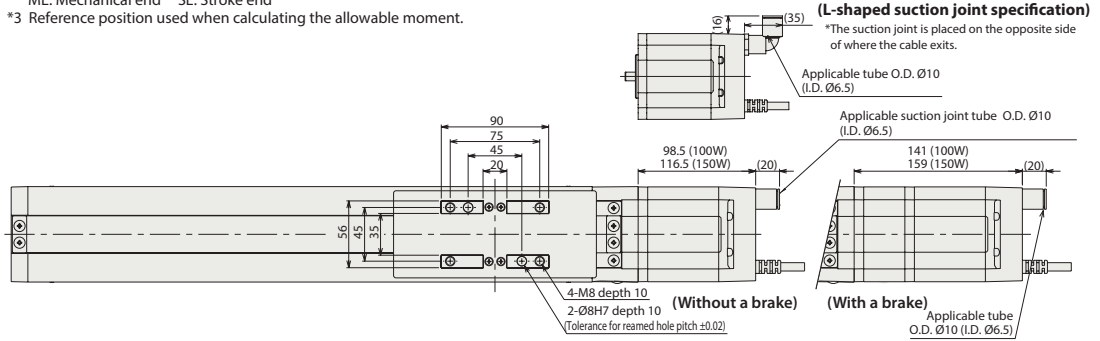

(L-shaped suction joint specification)
*The suction joint is placed on the opposite side of where the cable exits.
Applicable tube O.D. Ø10 (I.D. Ø6.5)

Applicable suction joint tube O.D. Ø10 (I.D. Ø6.5)
141 (100W)
159 (150W)
Applicable tube O.D. Ø10 (I.D. Ø6.5)

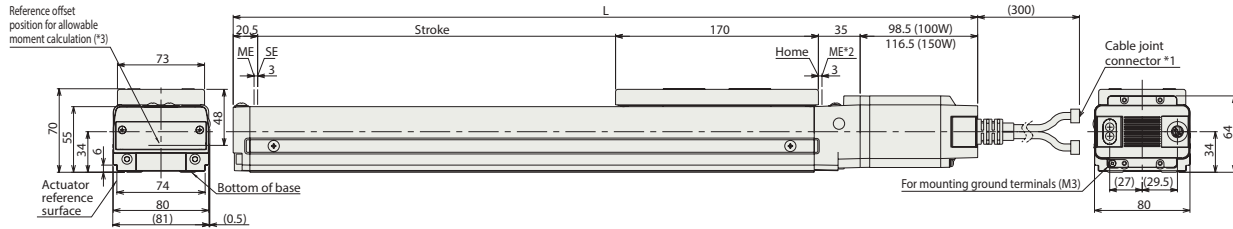

Reference offset position for allowable moment calculation (*3)
Actuator reference surface

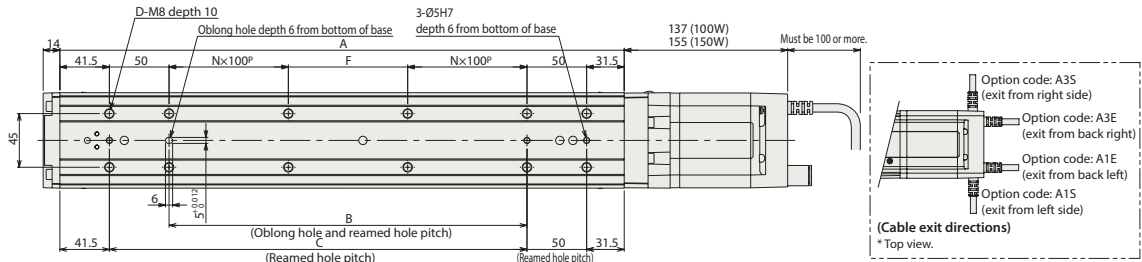

Dimensions and Mass by Stroke

Stroke	Stroke																					
	50	100	150	200	250	300	350	400	450	500	550	600	650	700	750	800	850	900	950	1,000		
L	100W	Without brake	374	424	474	524	574	624	674	724	774	824	874	924	974	1,024	1,074	1,124	1,174	1,224	1,274	1,324
		With brake	416.5	466.5	516.5	566.5	616.5	666.5	716.5	766.5	816.5	866.5	916.5	966.5	1,016.5	1,066.5	1,116.5	1,166.5	1,216.5	1,266.5	1,316.5	1,366.5
	150W	Without brake	392	442	492	542	592	642	692	742	792	842	892	942	992	1,042	1,092	1,142	1,192	1,242	1,292	1,342
		With brake	434.5	484.5	534.5	584.5	634.5	684.5	734.5	784.5	834.5	884.5	934.5	984.5	1,034.5	1,084.5	1,134.5	1,184.5	1,234.5	1,284.5	1,334.5	1,384.5
A		223	273	323	373	423	473	523	573	623	673	723	773	823	873	923	973	1,023	1,073	1,123	1,173	
B		50	100	150	200	250	300	350	400	450	500	550	600	650	700	750	800	850	900	950	1,000	
C		100	150	200	250	300	350	400	450	500	550	600	650	700	750	800	850	900	950	1,000	1,050	
D		8	8	8	10	12	12	12	14	16	16	16	18	20	20	20	22	24	24	24	26	
F		50	100	150	0	50	100	150	0	50	100	150	0	50	100	150	0	50	100	150	0	
N		0	0	0	1	1	1	1	2	2	2	3	3	3	3	3	4	4	4	4	5	
Mass (kg)	100W	Without brake	5.3	5.8	6.4	6.9	7.5	8.0	8.6	9.1	9.7	10.2	10.8	11.3	11.9	12.4	13.0	13.5	14.1	14.6	15.2	15.7
		With brake	5.7	6.2	6.8	7.3	7.9	8.4	9.0	9.5	10.1	10.6	11.2	11.7	12.3	12.8	13.4	13.9	14.5	15.0	15.6	16.1
	150W	Without brake	5.3	5.9	6.4	7.0	7.5	8.1	8.6	9.2	9.7	10.3	10.8	11.4	11.9	12.5	13.0	13.6	14.1	14.7	15.2	15.8
		With brake	5.8	6.3	6.9	7.4	8.0	8.5	9.1	9.6	10.2	10.7	11.3	11.8	12.4	12.9	13.5	14.0	14.6	15.1	15.7	16.2



Feature

1 Compatible with Battery-less Absolute Encoder *ACON-CB only

RCA equipped with a battery-less absolute encoder is supported. Since no battery is needed to retain position data, less space is required in the control panel, which in turn leads to lower both initial and maintenance costs of your equipment.



2 Compatible with Many Major Field Networks

Compatible with DeviceNet, CC-Link, PROFIBUS-DP, PROFINET IO, CompoNet, MECHATROLINK (I / II), EtherCAT, and EtherNet/IP. Field network connection allows for less-wiring, direct numerical commands, position number commands, current position reading, and more.



3 Maintenance Timings Can Be Checked Using the Traveled Distance Calculation Function

The total distance traveled by the actuator is calculated and recorded in the controller. If the preset distance is exceeded, a signal is output from the controller. This function can be used to check when to add grease or perform the next periodic inspection.

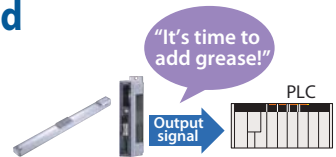

A signal is automatically output to the PLC when the preset maintenance/inspection timing (number of operations or distance traveled) is reached.



<Maintenance information>

4 The Calendar Function Can Retain Alarm Timestamps

The built-in calendar function (clock function) records alarms and other events with timestamps, which helps analyze the causes of troubles should they occur.

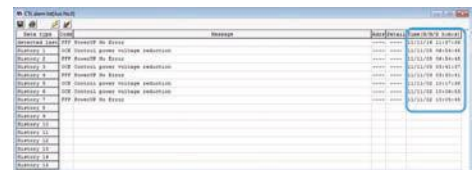

5 Equipped with the Offboard Tuning Function *ACON-CB only

The offboard tuning function lets you set an optimal gain for the load.

List of Models

Models		ACON-CB / DCON-CB									
External view											
I/O type		Positioner type	Pulse-train type	Field Network type							
				DeviceNet	CC-Link	PROFIBUS-DP	CompoNet	MECHATROLINK I/II	EtherCAT	EtherNet/IP	PROFINET IO
I/O type model number		NP/PN	PLN/PLP	DV	CC	PR	CN	ML	EC	EP	PRT
ACON-CB	Battery-less absolute spec. Incremental spec.	-	-	-	-	-	-	-	-	-	-
	Simple absolute spec.	With absolute battery	-	-	-	-	-	-	-	-	-
		With absolute battery unit	-	-	-	-	-	-	-	-	-
		Without absolute battery	-	-	-	-	-	-	-	-	-
Absolute specification		-	-	-	-	-	-	-	-	-	-
DCON-CB Incremental specification		-	-	-	-	-	-	-	-	-	-

* Please choose a simple absolute spec. when you use incremental spec. of RCA and RCA2 series actuator as absolute specification. When you use absolute spec of RCA series actuator, please choose an absolute spec. controller.

Model Specification Items

ACON — [] — [] — [] — [] — [] — [] — [] — [] — []

Series Type Motor Type Encoder Type Option I/O Type I/O Cable Length Supply Power Simple Absolute Option Mounting Option

CB	Standard type		WAI	Battery-less absolute/incremental	HA	Hi accel./decel.	0	DC24V	
CGB	Safety category compliant		A	Absolute	LA	Energy-saving			

2	2W motor	NP	PIO (NPN)				0	No cable	(Blank)	Battery-less absolute spec. Incremental spec. Absolute spec.
5	5W motor	PN	PIO (PNP)				2	2m	AB	Simple absolute spec. (With absolute battery)
5S	5W motor (*1)	PLN	Pulse-train (NPN)				3	3m	ABU	Simple absolute spec. (With absolute battery unit)
10	10W motor	PLP	Pulse-train (PNP)				5	5m	ABUN	Simple absolute spec. (Without absolute battery)
20	20W motor	DV	DeviceNet						(Blank)	Screw mounting
20S	20W motor (*2)	CC	CC-Link						DN	DIN rail mounting
30	30W motor	PR	PROFIBUS-DP							
		CN	CompoNet							
		ML	MECHATROLINK I/II							
		EC	EtherCAT							
		EP	EtherNet/IP							
		PRT	PROFINET IO							

(*1) When connecting RCA2-SA2AC/RA2AC
(*2) When connecting RCA-RA3□/RGS3□/RGD3□/RCA2-SA4□/TA5□

* If you choose a field network specification, the length of I/O cable will be "0"

* Simple absolute spec. can be chosen when the actuator's encoder type is incremental type.

DCON — [] — [] — [] — [] — [] — [] — [] — [] — []

Series Type Motor Type Encoder Type I/O Type I/O Cable Length Supply Power Mounting Option

CB	Standard type		I	Incremental			0	DC24V	
CGB	Safety category compliant								

3	2.5W DC brush-less motor	NP	PIO (NPN)				0	No cable	(Blank)	Screw mounting
		PN	PIO (PNP)				2	2m	DN	DIN rail mounting
		PLN	Pulse-train (NPN)				3	3m		
		PLP	Pulse-train (PNP)				5	5m		
		DV	DeviceNet							
		CC	CC-Link							
		PR	PROFIBUS-DP							
		CN	CompoNet							
		ML	MECHATROLINK I/II							
		EC	EtherCAT							
		EP	EtherNet/IP							
		PRT	PROFINET IO							

* If you choose a field network specification, the length of I/O cable will be "0"

System Configuration

<ACON-CB/CGB>

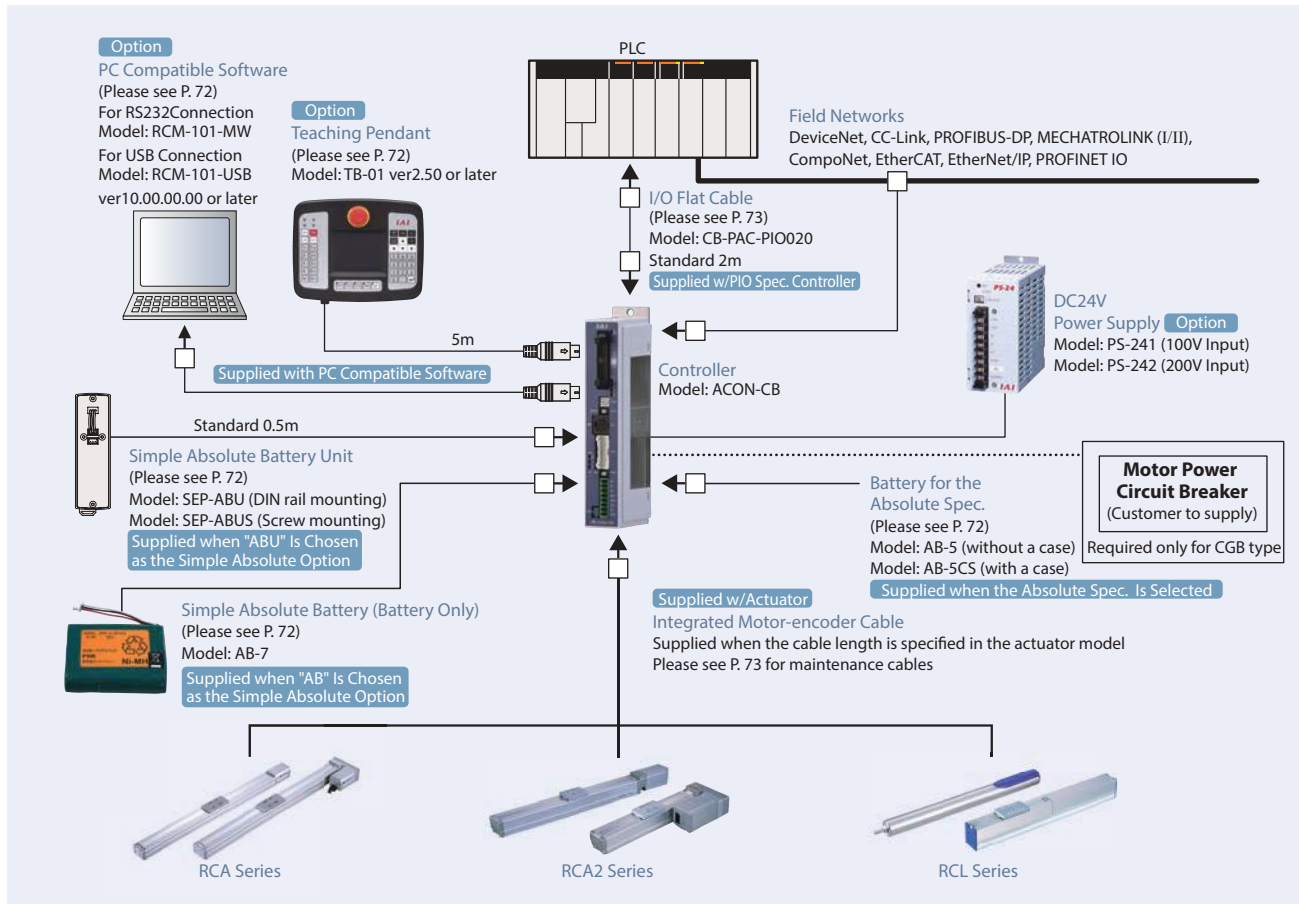

<DCON-CB/CGB>

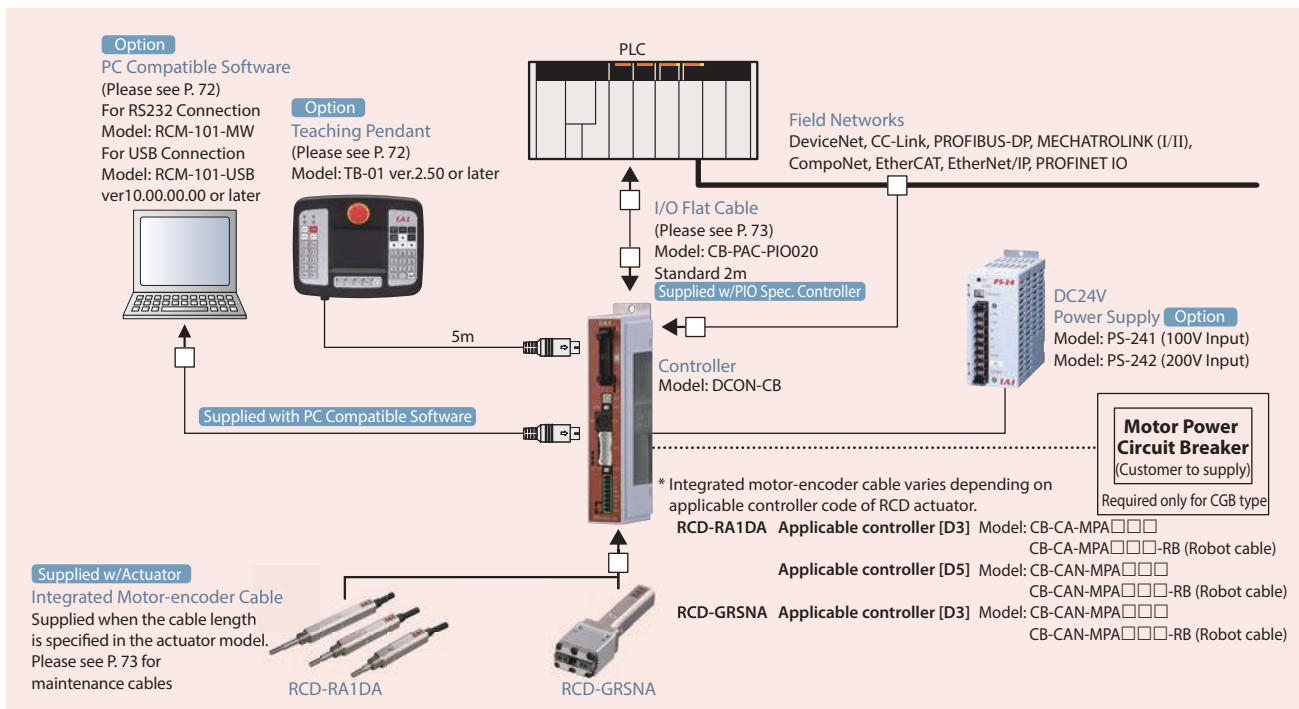

PIO I/O Interface (Common to ACON-CB/DCON-CB)

Input Part External Input Specification

Item	Specification
Input voltage	DC24V ±10%
Input current	5mA 1 circuit
ON/OFF voltage	ON voltage DC18V Min. OFF voltage DC6V Max.

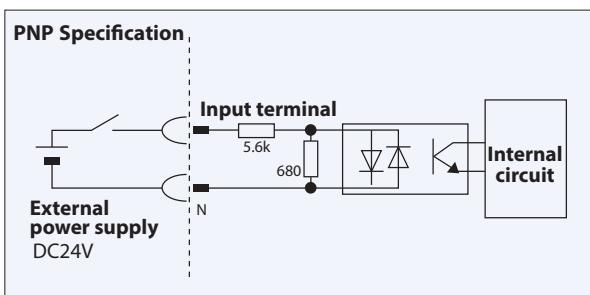
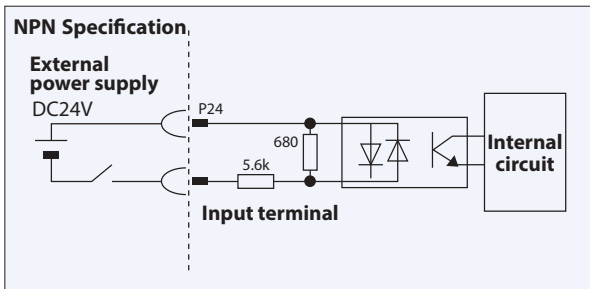

Output Part External Output Specification

Item	Specification
Load voltage	DC24V
Max. load current	50mA 1 circuit
Leak current	2mA Max. / point

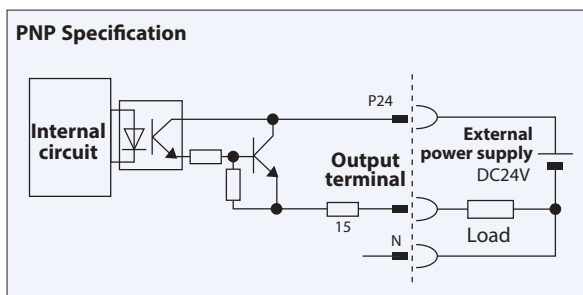
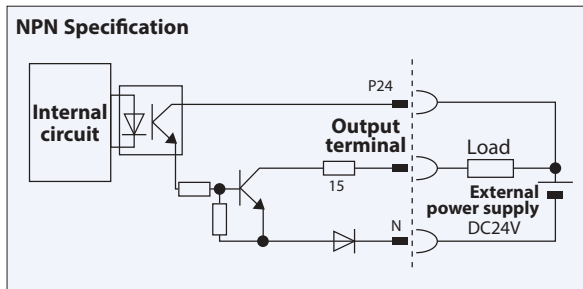

Types of PIO Patterns(Control Patterns) (Common to ACON-CB/DCON-CB)

There are 8 types of control methods ACON-CB and DCON-CB support.

Please select in Parameter #25 (PIO Pattern selection) the pattern which best suits your purpose of use.

Type	Set value of parameter #25	Mode	Summary
PIO Pattern 0	0 (Factory setting)	Positioning mode (Standard type)	Number of positioning points: 64 points Position number command: Binary Coded Decimal (BCD) Zone signal output (*1): 1 point Position zone signal output (*2): 1 point
PIO Pattern 1	1	Teaching mode (Teaching type)	Number of positioning points: 64 points Position number command: Binary Coded Decimal (BCD) Position zone signal output (*2): 1 point Jog (inching) operation using PIO signals is supported Current position data can be written to the position table using PIO signals
PIO Pattern 2	2	256-point mode (256 positioning points)	Number of positioning points: 256 points Position number command: Binary Coded Decimal (BCD) Position zone signal output (*2): 1 point
PIO Pattern 3	3	512-point mode (512 positioning points)	Number of positioning points: 512 points Position number command: Binary Coded Decimal (BCD) No position zone signal output
PIO Pattern 4	4	Solenoid valve mode 1 (7-point type)	Number of positioning points: 7 points Position number command: Individual number signal ON Zone signal output (*1): 1 point Position zone signal output (*2): 1 point
PIO Pattern 5	5	Solenoid valve mode 2 (3-point type)	Number of positioning points: 3 points Position number command: Individual number signal ON Completion signal: A signal equivalent to a LS (limit switch) signal can be output Zone signal output (*1): 1 point Position zone signal output (*2): 1 point
PIO Pattern 6 (Note 1)	6	Pulse-train mode for incremental	Differential pulse input (200 kpps max.) Home return function Zone signal output (*1): 2 points No feedback pulse output
PIO Pattern 7 (Note 1)	7	Pulse-train mode for absolute	Setting a reference point (1 place) Differential pulse input (200 kpps max.) Home return function Zone signal output (*1): 2 points No feedback pulse output

(*1) Zone signal output: A desired zone is set by Parameter #1 and 2 or 23 and 24, and the set zone always remains effective once home return has completed.
(*2) Position zone signal output: This function is available as part of a position number. A desired zone is set in the position table and becomes effective only when the corresponding position is specified, but not with commands specifying other positions.
(Note 1) Pulse Train Control Model is available only if the pulse train control type is indicated (from ACON-PLN/PLP and DCON-PLN/PLP) at the time of purchase.

PIO Patterns and Signal Assignments (Common to ACON-CB/DCON-CB)

The table below lists the signal assignments for the I/O flat cable under different PIO patterns. Please connect an external device (such as PLC) according to this table.

Pin #	Category	PIO function	Parameter No. 25, "PIO pattern selection"					
			0	1	2	3	4	5
			Positioning mode	Teaching mode	256-point mode	512-point mode	Solenoid valve 1	Solenoid valve 2
Pin #	Input	# of positioning point	64 points	64 points	256 points	512 points	7 points	3 points
		Home return signal	○	○	○	○	○	×
		Jog signal	×	○	×	×	×	×
		Teaching signal (writing current position)	×	○	×	×	×	×
	Output	Brake release	○	×	○	○	○	○
		Moving signal	○	○	×	×	×	×
		Zone signal	○	△ (*1)	△ (*1)	×	○	○
		Position zone signal	○	○	○	×	○	
1A	24V	P24						
2A	24V	P24						
3A	Pulse Input	-						
4A		-						
5A	Input	IN0	PC1	PC1	PC1	PC1	ST0	ST0
6A		IN1	PC2	PC2	PC2	PC2	ST1	ST1(JOG+)
7A		IN2	PC4	PC4	PC4	PC4	ST2	ST2 (*2)
8A		IN3	PC8	PC8	PC8	PC8	ST3	-
9A		IN4	PC16	PC16	PC16	PC16	ST4	-
10A		IN5	PC32	PC32	PC32	PC32	ST5	-
11A		IN6	-	MODE	PC64	PC64	ST6	-
12A		IN7	-	JISL	PC128	PC128	-	-
13A		IN8	-	JOG+	-	PC256	-	-
14A		IN9	BKRL	JOG-	BKRL	BKRL	BKRL	BKRL
15A		IN10	RMOD	RMOD	RMOD	RMOD	RMOD	RMOD
16A		IN11	HOME	HOME	HOME	HOME	HOME	-
17A		IN12	*STP	*STP	*STP	*STP	*STP	-
18A		IN13	CSTR	CSTR/PWRT	CSTR	CSTR	-	-
19A		IN14	RES	RES	RES	RES	RES	RES
20A	IN15	SON	SON	SON	SON	SON	SON	
1B	Output	OUT0	PM1(ALM1)	PM1(ALM1)	PM1(ALM1)	PM1(ALM1)	PE0	LSO
2B		OUT1	PM2(ALM2)	PM2(ALM2)	PM2(ALM2)	PM2(ALM2)	PE1	LS1(TRQS)
3B		OUT2	PM4(ALM4)	PM4(ALM4)	PM4(ALM4)	PM4(ALM4)	PE2	LS2 (*2)
4B		OUT3	PM8(ALM8)	PM8(ALM8)	PM8(ALM8)	PM8(ALM8)	PE3	-
5B		OUT4	PM16	PM16	PM16	PM16	PE4	-
6B		OUT5	PM32	PM32	PM32	PM32	PE5	-
7B		OUT6	MOVE	MOVE	PM64	PM64	PE6	-
8B		OUT7	ZONE1	MODES	PM128	PM128	ZONE1	ZONE1
9B		OUT8	PZONE/ZONE2	PZONE/ZONE1	PZONE/ZONE1	PM256	PZONE/ZONE2	PZONE/ZONE2
10B		OUT9	RMDS	RMDS	RMDS	RMDS	RMDS	RMDS
11B		OUT10	HEND	HEND	HEND	HEND	HEND	HEND
12B		OUT11	PEND	PEND/WEND	PEND	PEND	PEND	-
13B		OUT12	SV	SV	SV	SV	SV	SV
14B		OUT13	*EMGS	*EMGS	*EMGS	*EMGS	*EMGS	*EMGS
15B		OUT14	*ALM	*ALM	*ALM	*ALM	*ALM	*ALM
16B	OUT15	*BALM (*3)/*ALML	*BALM (*3)/*ALML	*BALM (*3)/*ALML	*BALM (*3)/*ALML	*BALM (*3)/*ALML	*BALM (*3)/*ALML	
17B	Pulse Input	-						
18B		-						
19B	0V	N						
20B	0V	N						

(*) In the table above, asterisk * symbol accompanying each code indicates a negative logic signal. PM1 to PM8 are alarm binary code output signals that are used when an alarm generates.

(*1) In all PIO patterns other than 3, this signal can be switched with PZONE by setting Parameter No. 149 accordingly.

(*2) The setting will not become effective until the home return is completed.

(*3) This signal is dedicated only for ACON-CB.

Reference: Negative logic signal

Signals denoted by * are negative logic signals. Negative logic input signals are processed when turned OFF.

Negative logic output signals normally remain ON while the power is supplied, and turn OFF when the signal is output.

Pulse-train Control Circuit (Common to ACON-CB/DCON-CB)

■ Host Unit = Differential Type

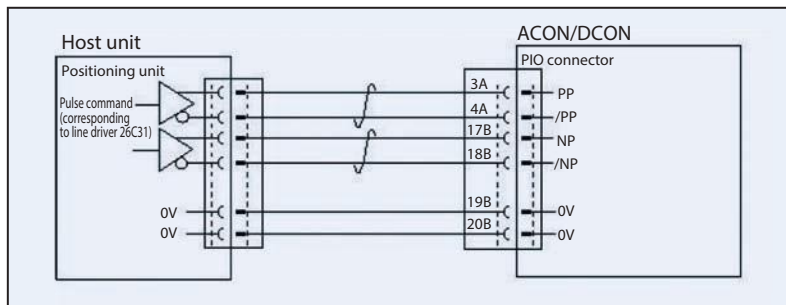

■ Host Unit = Open Collector Type

The AK-04 (optional) is needed to input pulses.

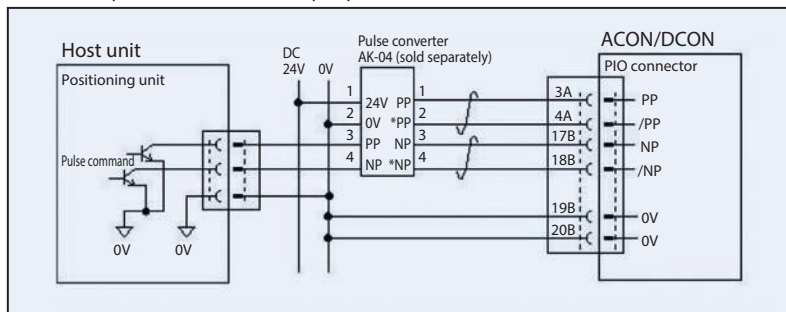

Pulse Converter: AK-04

Open-collector command pulses are converted to differential command pulses.

Use this converter if the host controller outputs open-collector pulses.

■ Specification

Item	Specification
Input power	DC24V ±10% (max. 50mA)
Input pulse	Open-collector (Collector current: max. 12mA)
Input frequency	200kHz or less
Output pulse	Differential output (max. 10mA) (26C31 or equiv.)
Mass	10g or less (excluding cable connectors)
Accessories	37104-3122-000L (3M) (e-CON connector) x 2 Applic. wire: AWG No. 24~26

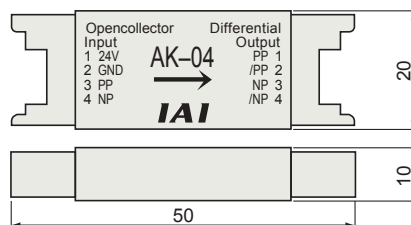

Caution: Use the same power supply for open collector input/output to/from the host and for the AK-04.

Command Pulse Input Patterns

	Command pulse-train pattern	Input terminal	Forward	Reverse	
			Pulse-train waveforms		
Negative logic	Forward pulse-train	PP/PP	[Pulse-train diagram]	[Pulse-train diagram]	
	Reverse pulse-train	NP/NP	[Pulse-train diagram]	[Pulse-train diagram]	
	A forward pulse-train indicates the amount of motor rotation in the forward direction, while a reverse pulse-train indicates the amount of motor rotation in the reverse direction.				
	Pulse-train	PP/PP	[Pulse-train diagram]	[Pulse-train diagram]	
	Sign	NP/NP	Low	High	
	The command pulses indicate the amount of motor rotation, while the sign indicates the rotating direction.				
Positive logic	Forward pulse train	PP/PP	[Pulse-train diagram]	[Pulse-train diagram]	
	Reverse pulse-train	NP/NP	[Pulse-train diagram]	[Pulse-train diagram]	
	Pulse-train	PP/PP	[Pulse-train diagram]	[Pulse-train diagram]	
	Sign	NP/NP	High	Low	
	Phase A/B pulse-train	PP/PP	[Pulse-train diagram]	[Pulse-train diagram]	
		NP/NP	[Pulse-train diagram]	[Pulse-train diagram]	
Command phases A and B having a 90° phase difference (multiplier is 4) indicate the amount of rotation and the rotating direction.					

I/O Signals in Pulse-train Control Mode (Common to ACON-CB/DCON-CB)

The table below lists the signal assignments for the flat cable in the pulse-train control mode. Please connect an external device (such as PLC) according to this table.

Parameter #25 (PIO patterns 6/7)					
Pin number	Category	I/O number	Signal abbreviation	Signal name	Function description
1A	24V		P24	Power supply	I/O power supply +24 V
2A	24V		P24	Power supply	I/O power supply +24 V
3A	Pulse input		PP	Differential pulse-train input (+)	Differential pulses are input from the host. Up to 200 kpps can be input.
4A			/PP	Differential pulse-train input (-)	
5A	Input	IN0	SON	Servo ON	The servo is ON while this signal is ON, and OFF while the signal is OFF.
6A		IN1	RES	Reset	Present alarms are reset when this signal is turned ON.
7A		IN2	HOME	Home return	Home return operation is performed when this signal is turned ON.
8A		IN3	TL	Torque limit selection	When this signal is turned ON, the motor torque is limited to the value set by the parameter.
9A		IN4	CSTP	Forced stop	The actuator is forcibly stopped when this signal has remained ON for 16ms or more. The actuator decelerates to a stop at the torque set in the controller and the servo turns OFF.
10A		IN5	DCLR	Deviation counter clear	This signal clears the deviation counter.
11A		IN6	BKRL	Forced brake release	The brake is forcibly released.
12A		IN7	RMOD	Operation mode switching	The operation mode can be switched when the MODE switch on the controller is set to AUTO. (AUTO when this signal is OFF, and to MANU when the signal is ON.)
13A		IN8	RSTR*1	Reference position movement command	When this signal turns ON, the movement to the position set in parameter No. 167 starts. *1: Used only in PIO Pattern 7
14A		IN9	NC	—	Not used
15A		IN10	NC	—	Not used
16A		IN11	NC	—	Not used
17A		IN12	NC	—	Not used
18A		IN13	NC	—	Not used
19A		IN14	NC	—	Not used
20A	IN15	NC	—	Not used	
1B	Output	OUT0	PWR	System ready	This signal turns ON when the controller becomes ready after the main power has been turned on.
2B		OUT1	SV	Servo ON status	This signal turns ON when the servo is ON.
3B		OUT2	INP	Positioning complete	This signal turns ON when the amount of remaining travel pulses in the deviation counter falls within the in-position band.
4B		OUT3	HEND	Home return complete	This signal turns ON upon completion of home return.
5B		OUT4	TLR	Torque limited	This signal turns ON upon reaching the torque limit while the torque is limited.
6B		OUT5	*ALM	Controller alarm status	This signal turns ON when the controller is normal, and turns OFF when an alarm generates.
7B		OUT6	*EMGS	Emergency stop status	This signal turns ON when the emergency stop of the controller is cancelled, and turns OFF when an emergency stop is actuated.
8B		OUT7	RMDS	Operation mode status	The operation mode status is output. This signal turns ON when the controller is in the manual mode.
9B		OUT8	ALM1	Alarm code output signal	An alarm code is output when an alarm generates. For details, refer to the operation manual.
10B		OUT9	ALM2		
11B		OUT10	ALM4		
12B		OUT11	ALM8		
13B		OUT12	*ALML	Minor failure alarm	This signal turns ON when the controller is normal, and turns OFF when a message-level alarm is generated.
14B		OUT13	REND*1	Reference position movement complete	The signal turns ON when the movement to the reference position set in parameter No. 167 is completed. *1: Used only in PIO Pattern 7
15B		OUT14	ZONE1	Zone signal 1	This signal turns ON when the current position of the actuator falls within the parameter-set range.
16B	OUT15	ZONE2	Zone signal 2		
17B	Pulse input		NP	Differential pulse-train input (+)	Differential pulses are input from the host. Up to 200 kpps can be input.
18B			/NP	Differential pulse-train input (-)	
19B	0V		N	Power supply	I/O power supply 0V
20B	0V		N	Power supply	I/O power supply 0V

(Note) * indicates a negative logic signal. Negative logic signals are normally ON while the power is supplied, and turn OFF when the signal is output.

Field Network Specification: Explanation of Operation Modes (Common to ACON-CB/DCON-CB)

If the ACON-CB/DCON-CB is controlled via a field network, you can select one of the following five modes to operate the actuator.

Please note that the data areas required on the PLC side will vary depending on the mode.

Mode Descriptions

Mode	Description
0 Remote I/O mode	Similarly to the PIO specification, this mode operates by directing bytes to ON/OFF via a network. The number of positioning points and functions will vary depending on the operation patterns (PIO patterns) set by the controller's parameters.
1 Position/simple direct value mode	The target position value is directly inputted, while all other operational conditions (speed, acceleration, etc) are set by indicating the position number corresponding to the desired operating conditions from the position data table.
2 Half direct value mode	The actuator is operated by directly inputting values for speed, acceleration/deceleration rate and push current, as well as the target position.
3 Full direct value mode	The actuator is operated by directly inputting values for the target position, speed, acceleration/deceleration rate and push current, etc. In addition, you are able to read the current position, current speed, and the specified current, etc.
4 Remote I/O mode 2	This mode is the same as the remote I/O mode above, with the added functionality of reading current position and the specified current.

Required Data Size for Each Network

	DeviceNet	CC-Link	PROFIBUS-DP	CompoNet	MECHATROLINK I/II	EtherCAT	EtherNet/IP	PROFINET IO
0 Remote I/O mode	2 bytes	1 station	2 bytes	2 bytes	*	2 bytes	2 bytes	2 bytes
1 Position/simple direct value mode	8 bytes	1 station	8 bytes	8 bytes	*	8 bytes	8 bytes	8 bytes
2 Half direct value mode	16 bytes	2 stations	16 bytes	16 bytes	*	16 bytes	16 bytes	16 bytes
3 Full direct value mode	32 bytes	4 stations	32 bytes	32 bytes	x (Note 1)	32 bytes	32 bytes	32 bytes
4 Remote I/O mode 2	12 bytes	1 station	12 bytes	12 bytes	*	12 bytes	12 bytes	12 bytes

*** indicates that no required data size is set for MECHATROLINK I and II.
 (Note 1) Please note that the MECHATROLINK specification does not support the full direct value mode.

List of Functions by Operation Mode

	Remote I/O mode	Position/simple direct value mode	Half direct value mode	Full direct value mode (Note 1)	Remote I/O mode 2
Number of positioning points	512 points	768 points	Unlimited	Unlimited	512 points
Operation by direct position data input	x	○	○	○	x
Direct speed /acceleration input	x	x	○	○	x
Push-motion operation	○	○	○	○	○
Current position read	x	○	○	○	○
Current speed read	x	x	○	○	x
Operation by position number input	○	○	x	x	○
Completed position number read	○	○	x	x	○

* "○" indicates that the operation is supported, and "x" indicates that it is not supported.
 (Note 1) Please note that the MECHATROLINK specification does not support the full direct value mode.

External Dimensions (Common to ACON-CB/DCON-CB)

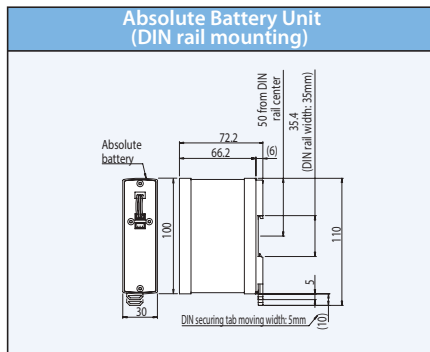
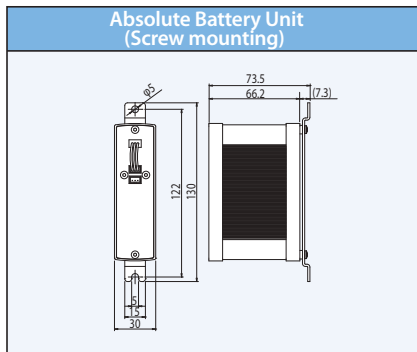
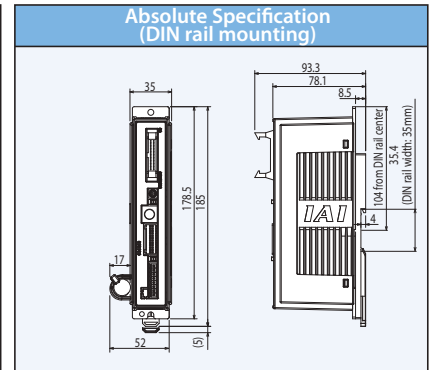
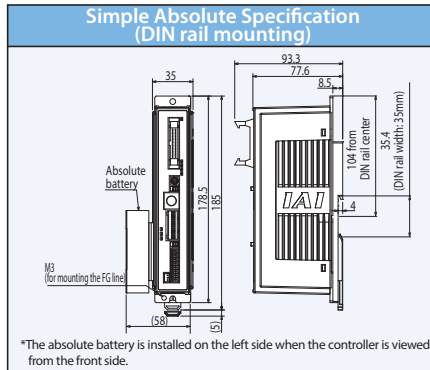
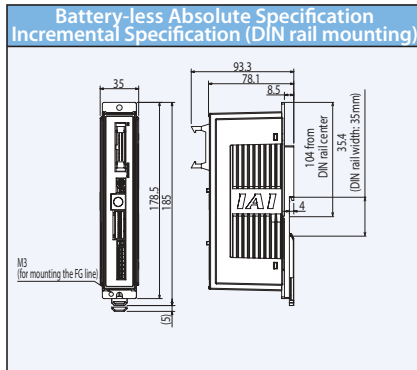
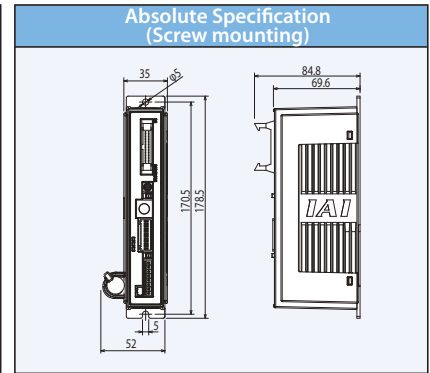
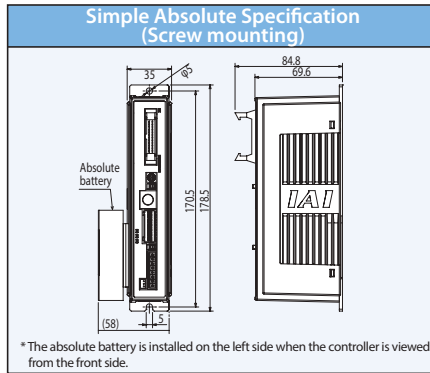
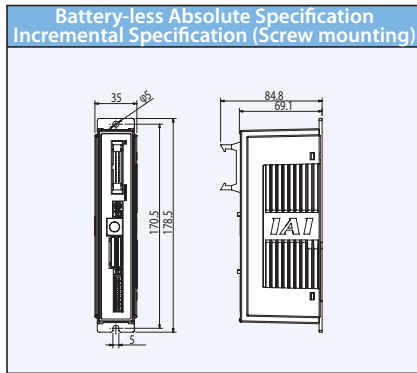

Specification Table

Item	ACON-CB	DCON-CB
Number of controlled axes	1 axis	
Power supply voltage	DC24V ±10%	
Rush current from power supply	10A (Rush current limiting circuit is provided)	
Cooling method	Natural air cooling	
Off-board tuning	Available (RCA only)	Not available
Backup memory	FRAM (256kbit) Number of rewrite: No limit	
I/O power supply	DC24V ±10%	
Number of I/Os	16IN/16OUT	
Pulse-train specification	Available (differential type only: AK-04 is used for the open-collector type)	
Fieldbus specification	Available	
Serial communication	RS485: 1 channel (conforming to Modbus protocol)	
Ambient operating temperature	0 to 40°C	
Ambient operating humidity	85% RH or less (non-condensing)	
Protection degree	IP20	
Mass	Battery-less absolute/Incremental spec.: 230g, simple absolute spec.: 240g (incl. battery: 430g) Absolute spec.: 240g (incl. battery: 260g)	Incremental specification: 230g —

Motor Power Capacity

	Motor type	Standard / High-accel/decel		Power-saving		
		Rated [A]	Max. [A]	Rated [A]	Max. [A]	
ACON-CB	RCA/RCA2	10W	1.3	4.4	1.3	2.5
		20W	1.3	4.4	1.3	2.5
		30W	1.3	4	1.3	2.2
		20W(20S)	1.7	5.1	1.7	3.4
	RCL	2W	0.8	4.6	—	—
		5W	1	6.4	—	—
		10W	1.3	6.4	—	—
DCON-CB	RCD	3W	0.7	1.5	—	—

Options (Common to ACON-CB/DCON-CB)

Teaching Pendant

■ Summary A teaching device that has position input, test operation, monitoring function, etc.

■ Model **TB-01-C**

■ Setting

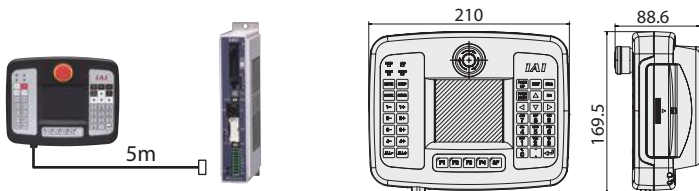

■ Specification

Rated voltage	DC24V
Power consumption	3.6W or less (150mA or less)
Ambient operating temperature	0 to 50°C
Ambient operating humidity	20 to 85%RH (Non-condensing)
Environmental resistance	IP40 (initial state)
Mass	507g (TB-01 only)

PC Compatible Software (Windows Only)

XP SP2 or later/Vista/7/8

■ Summary A startup support software for inputting positions, performing test runs, and monitoring. With enhancements for adjustment functions, the startup time is shortened.

■ Model **RCM-101-MW** (External device communication cable and RS232 conversion unit included)

ACON-CB/DCON-CB is supported by Ver.10.00.00.00 or later

■ Setting

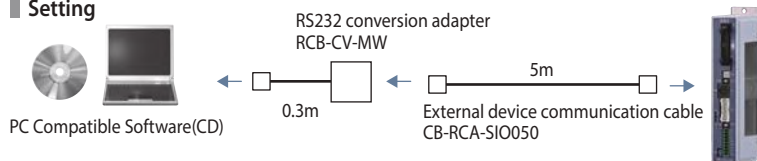

■ Model **RCM-101-USB** (External device communication cable, USB conversion adapter, and USB cable included)

ACON-CB/DCON-CB is supported by Ver.10.00.00.00 or later

■ Setting

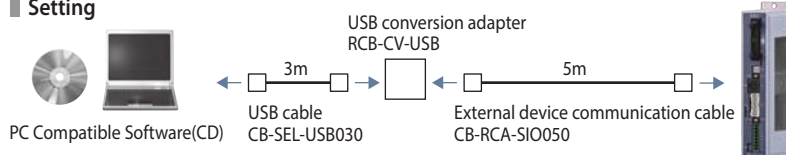

Absolute Battery Unit

■ Summary Battery unit that comes with a simple absolute specification, used to back up the current controller position.

■ Model **SEP-ABU** (DIN rail mounting specification)
SEP-ABUS (screw mounting specification)

■ Specification

Item	SEP-ABU / SEP-ABUS
Ambient operating temperature and humidity	0 to 40°C (desirably around 20°C), 95% RH or below (non-condensing)
Operating atmosphere	Free from corrosive gases
Absolute battery	Model: AB-7 (Ni-MH battery/Life: approx. 3 years)
Connection cable to connect between the controller and the absolute battery unit	Model: CB-APSEP-AB005 (length: 0.5m)
Mass	Battery box: 140g or less Battery: 140g or less

Replacement Battery (for Simple Absolute Spec.)

■ Summary The replacement battery for the simple absolute specification.

■ Model **AB-7**



Replacement Battery (for Absolute Spec.)

■ Summary The replacement battery for the absolute specification.

■ Model **AB-5**



Maintenance Parts

Model Number **CB-ASEP2-MPA** **Integrated Motor-Encoder Robot Cable** **for [RCA]-[ACON-CB] Connection**

*Please indicate the cable length (L) in (e.g. 080=8m). Maximum length = 20m

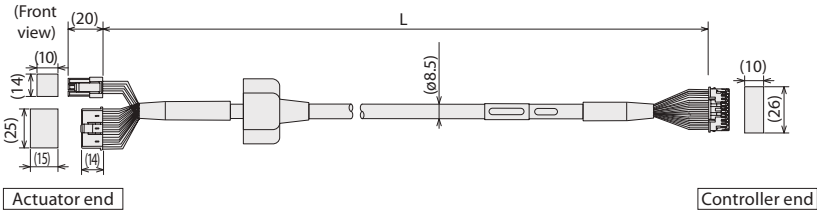

Minimum bending radius R = 68mm or more (Dynamic bending condition)

*Only robot cable is available for this model.

Actuator end Pin number		Controller end Pin number
1	Red (U)	1
2	Yellow (V)	2
	NC	3
	NC	4
3	Black (W)	5
	NC	6
18	Orange (BK+)	7
17	Gray (BK-)	8
7	Black (LS+)	9
16	Brown (LS-)	10
1	White (A+)	11
2	Yellow (A-)	12
3	Red (B+)	13
4	Green (B-)	14
10	Black (identification tape) (Z+)	15
11	Brown (identification tape) (Z-)	16
14	White (identification tape) (VCC)	17
13	Red (identification tape) (VPS/BAF)	18
15	Yellow (identification tape) (GND)	19
6	Green (identification tape) (spare)	20
12	White (BAT+)	21
5	NC	22
8	NC	23
9	Shield (FG)	24

Model Number **CB-APSEP-MPA** **Integrated Motor-Encoder Robot Cable** **for [RCA2/RCL]-[ACON-CB] Connection**

*Please indicate the cable length (L) in (e.g. 080=8m). Maximum length = 20m

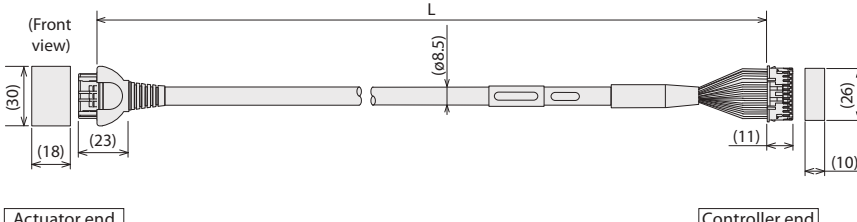

Minimum bending radius R = 68mm or more (Dynamic bending condition)

*Only robot cable is available for this model.

Actuator end Pin number		Controller end Pin number
A1	Black (oA) (U)	1
B1	White (VMM) (V)	2
A2	Brown (oA) (W)	5
B2	Green (oB) (-)	3
A3	Yellow (VMM) (-)	4
B3	Red (oB) (-)	6
A4	Orange (LS+) (BK+)	7
B4	Gray (LS-) (BK-)	8
A6	White (-) (A-)	11
B6	White (-) (A-)	12
A7	Red (A+) (B+)	13
B7	Green (A-) (B-)	14
A8	Black (B+) (Z+)	15
B8	Brown (B-) (Z-)	16
A5	Black (identification tape) (BK+) (LS+)	9
B5	Brown (identification tape) (BK-) (LS-)	10
A9	Green (identification tape) (GNDLS) (GNDLS)	20
B9	Red (identification tape) (VPS) (VPS)	18
A10	White (identification tape) (VCC) (VCC)	17
B10	Yellow (identification tape) (GND) (GND)	19
A11	NC	21
B11	NC	22
	Shield (FG) (FG)	24
	NC	23
	NC	23

Model Number **CB-CAN-MPA** **Integrated Motor-Encoder Cable** **for [RCD]-[DCON-CB] Connection**
CB-CAN-MPA **-RB** **Integrated Motor-Encoder Robot Cable**

*Please indicate the cable length (L) in (e.g. 080=8m). Maximum length = 20m

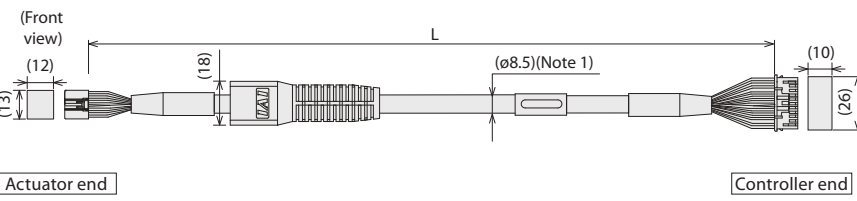

Minimum bending radius R = 68mm or more (Dynamic bending condition)

*The robot cable is designed for flex-resistance. Please use the robot cable if the cable has to be installed through the cable track.

Note 1) If the cable length is 5 m or more, the diameter of the non-robot cable becomes ø9.1 while that of the robot cable becomes ø10.

*The cable model code should be CB-CA-MPA /CB-CA-MPA -RB when "D3" is used as the applicable controller with RCD-RA1DA.

Pin no.	Signal name	Pin no.	Signal name
3	oA/U	1	oA/U
5	VMM/V	2	VMM/V
10	o A/W	3	o A/W
9	oB/-	4	oB/-
4	VMM/-	5	VMM/-
15	o B/+	6	o B/+
8	LS+/BK+	7	LS+/BK+
14	LS-/BK-	5	LS-/BK-
12	-/A+	11	-/A+
17	-/A-	12	-/A-
1	A+/B+	13	A+/B+
6	A-/B-	14	A-/B-
11	B+/Z+	15	B+/Z+
16	B-/Z-	16	B-/Z-
20	BK+/LS+	9	BK+/LS+
2	BK-/LS-	10	BK-/LS-
21	LS_GND	17	LS_GND
7	VPS	19	VPS
15	VCC	15	VCC
13	GND	20	GND
19	—	22	—
22	—	21	—
23	—	23	—
24	FG	24	FG

Model Number **CB-PAC-PIO** **I/O Flat Cable**

*Please indicate the cable length (L) in (e.g. 080=8m). Maximum length = 10m

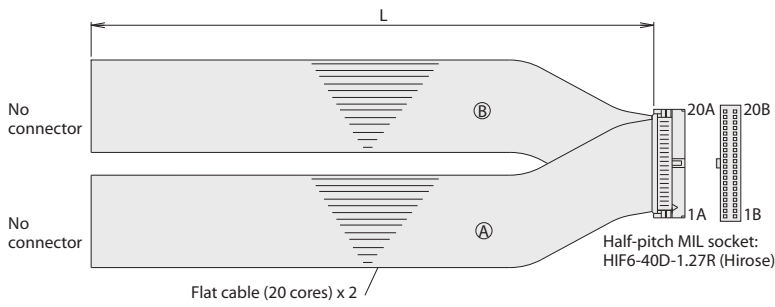

HIF6-40D-1.27R

No.	Signal name	Cable color	Wiring	No.	Signal name	Cable color	Wiring
1A	24V	Brown-1		1B	OUT0	Brown-3	
2A	24V	Red-1		2B	OUT1	Red-3	
3A	Pulse	Orange-1		3B	OUT2	Orange-3	
4A	input	Yellow-1		4B	OUT3	Yellow-3	
5A	IN0	Green-1		5B	OUT4	Green-3	
6A	IN1	Blue-1		6B	OUT5	Blue-3	
7A	IN2	Purple-1		7B	OUT6	Purple-3	
8A	IN3	Gray-1		8B	OUT7	Gray-3	
9A	IN4	White-1		9B	OUT8	White-3	
10A	IN5	Black-1		10B	OUT9	Black-3	
11A	IN6	Brown-2		11B	OUT10	Brown-4	
12A	IN7	Red-2		12B	OUT11	Red-4	
13A	IN8	Orange-2		13B	OUT12	Orange-4	
14A	IN9	Yellow-2		14B	OUT13	Yellow-4	
15A	IN10	Green-2		15B	OUT14	Green-4	
16A	IN11	Blue-2		16B	OUT15	Blue-4	
17A	IN12	Purple-2		17B	Pulse	Purple-4	
18A	IN13	Gray-2		18B	input	Gray-4	
19A	IN14	White-2		19B	OV	White-4	
20A	IN15	Black-2		20B	OV	Black-4	

SCON-CB



Position Controller for
Single-axis Robot / Cartesian Robot / Linear Servo / ROBO Cylinder RCS2/RCS3

Features

1 Compatible with Battery-less Absolute Encoder

The RCS2 and RCS3 equipped with a battery-less absolute encoder is supported. Since no battery is needed to retain position data, less space is required in the control panel, which contributes to saving initial cost and maintenance cost.



2 Supporting Major Field Networks <Optional Function>

Direct connection is now possible not only to DeviceNet, CC-Link and PROFIBUS-DP, but also to MECHATROLINK I/II, CompoNet, EtherCAT, EtherNet/IP and PROFINET IO. The actuator can also be operated by specifying coordinate values directly via a field network.



3 Vibration Control Function <Standard Function>

A vibration control function is equipped that suppresses vibration of the work part installed on the slider when the actuator's slider moves. This function shortens the time the actuator waits for vibration to settle, and consequently shortens the cycle time.

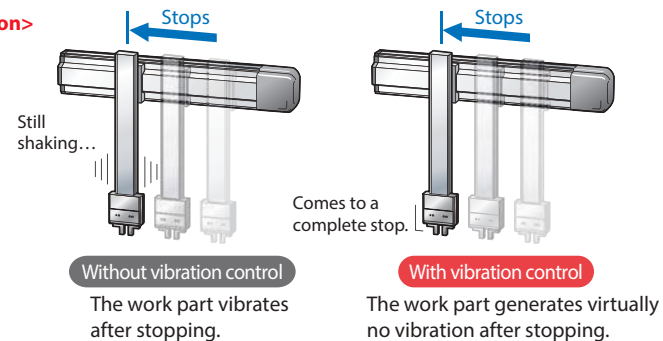





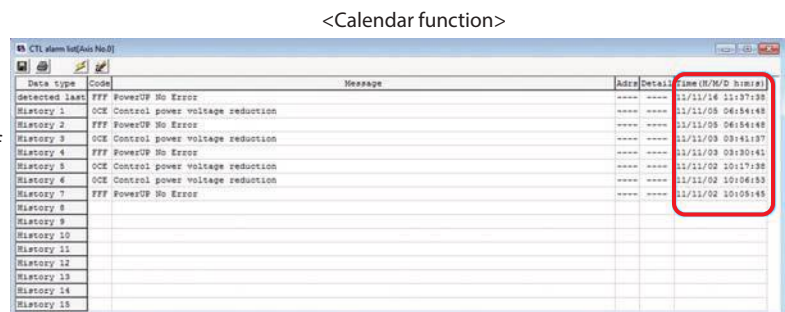
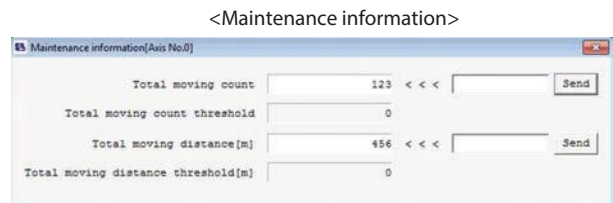



4 Capable of Predictive Maintenance <Standard Function>

- Equipped with a feature to detect motor overload and issue warning. By monitoring the motor temperature, abnormal changes can be detected before a malfunction or failure occurs.
- Fully equipped with a monitoring function. Like an oscilloscope, waveforms of position and speed can be acquired from the moment that the condition of a selected signal is changed. Signal status of positioning complete, alarm and so on can also be acquired.
- With smart tuning and off-board tuning, it is possible to adjust the acceleration/deceleration and gain depending on the payload.
- Using the counter function, the exact number of actuator movements and total distance traveled are calculated. This function can be used to output a signal when maintenance is required.
- The calendar function enables to retain the history of alarm occurrence.



List of Models

Model		SCON-CB									
External view											
I/O type		Standard specification	Field network type (*1)								
		PIO connection specification (*1)	       	DeviceNet	CC-Link	PROFIBUS-DP	CompoNet	MECHATRO LINK-I/II	EtherCAT	EtherNet/IP	PROFINET IO
I/O type code			NP/PN	DV	CC	PR	CN	ML	EC	EP	PRT
Applicable encoder type		Battery-less absolute Incremental Quasi-absolute	Absolute	Battery-less absolute/ Incremental/Absolute/Quasi-absolute							
SCON-CB	12~150W	—	—								
	200W	—	—								
	300~400W	—	—								
	600W	—	—	—	—	—	—	—	—	—	
	750W	—	—								
	750W <small>(For 750W actuator with load cell)</small>	—	—								

(*1) Note that communication with PIO and pulse train cannot be performed in the network type.

Model

SCON - [] - [] [] [] - [] - [] - []

Series Type Motor Type Encoder Type Option I/O Type I/O Cable Length Power Supply Voltage

CB	High-function type						1	Single phase AC100V
CGB	Safety category compliant type						2	Single phase AC 200V

12	12W motor	200	200W motor	WAI	Battery-less absolute Incremental	NP	PIO NPN (standard)	0	No cable
20	20W motor	200S	For LSA-S10H/N15 For LSAS-N15	A	Absolute	PN	PIO PNP	2	2m (standard)
30D	30W motor (for RCS2)	300S	For LSA-N19	G	Quasi-absolute	DV	DeviceNet connection	3	3m
30R	30W motor (for RS)	400	400W motor	*Quasi-absolute is for LSAS Series only		CN	CompoNet connection	5	5m
60	60W motor	600	600W motor			CC	CC-Link connection	* If you choose a field network specification, the length of the I/O cable will be "0"	
100	100W motor	750	750W motor			ML	MECHATROLINK-I/II		
100S	For LSA-N10 For LSAS-N10	750S	For 750W actuator with load cell			PR	PROFIBUS-DP		
150	150W motor					EC	EtherCAT		
						EP	EtherNet/IP		
						PRT	PROFINET IO		

System Configuration

<SCON-CB/CGB>

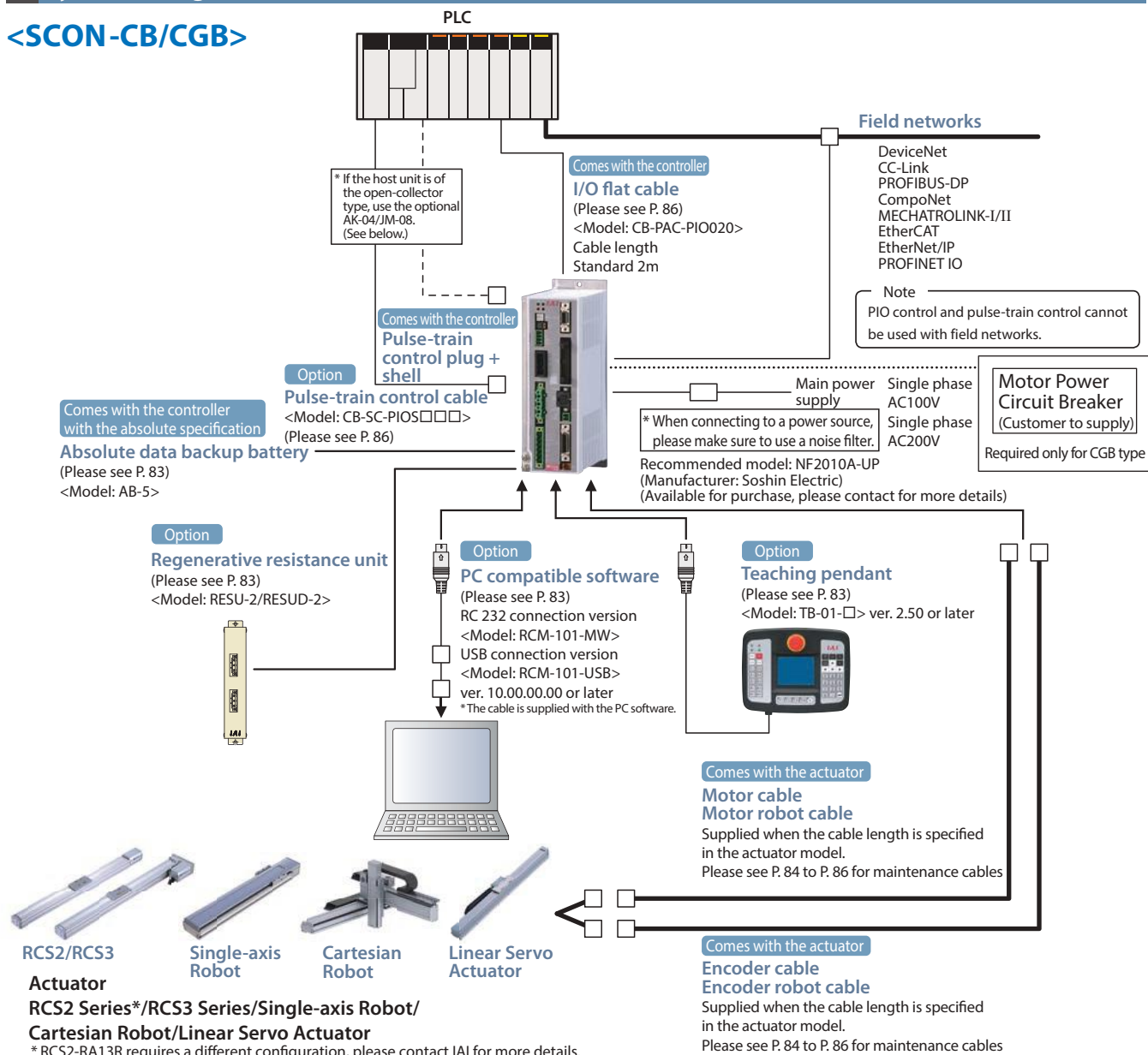

Pulse Converter: AK-04

Open-collector command pulses are converted to differential command pulses. Use this converter if the host controller outputs open-collector pulses.

Specification

Item	Specification
Input power supply	DC24V±10% (50mA max.)
Input pulse	Open-collector (Collector current: 12mA max.)
Input frequency	200kHz or less
Output pulse	Differential output (10mA max.) (26C31 or equivalent)
Mass	10g or less (excluding cable connectors)
Accessories	37104-3122-000L (e-CON connector)(by 3M) × 2 Suitable wire: AWG No.24~26

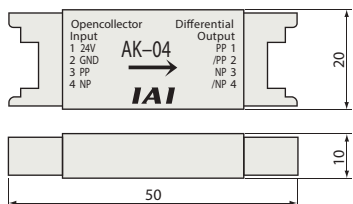

Pulse Converter: JM-08

Differential system pulse gets converted into the open collector type. Use this converter if the host controller inputs open-collector pulses.

Specification

Item	Specification
Input power supply	DC24V±10% (50mA max.)
Input pulse	Differential input (10mA max.) (conforming to RS422)
Input frequency	500kHz or less
Output pulse	24-VDC open-collector (Collector current: 25mA max.)
Mass	10g or less (excluding cable connectors)
Accessories	37104-3122-000FL (e-CON connector)(by 3M) × 2 Suitable wire: AWG No.24~26

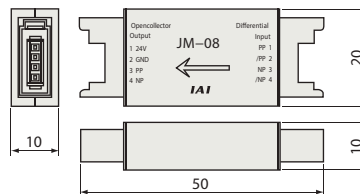

Operation Modes

With this controller, you can select a desired control method from the two modes of positioner mode and pulse-train control mode. In the positioner mode, you can enter position data (target position, speed, acceleration, etc.) in the controller under the desired numbers and then specify each number externally via a I/O (input/output signal) to operate the actuator.

Also, in the positioner mode, you can select the desired operation mode from the eight modes using the parameter.

In the pulse-train control mode, you can control the travel, speed, acceleration, etc., by sending pulses from an external pulse generator.

Mode		Type	Number of positioning points	Features
Positioner mode	Positioning mode	PIO pattern 0	64 points	Standard factory-set mode. Specify externally a number corresponding to the position you want to move to, to operate the actuator.
	Teaching mode	PIO pattern 1	64 points	In this mode, you can move the slider (rod) via an external signal and register the stopped position in the position data table.
	256-point mode	PIO pattern 2	256 points	In this mode, the number of positioning points available in the positioning mode has been increased to 256 points.
	512-point mode	PIO pattern 3	512 points	In this mode, the number of positioning points available in the positioning mode has been increased to 512 points.
	Solenoid valve mode 1	PIO pattern 4	7 points	In this mode, the actuator can be moved only by turning signals ON/OFF, just like you do with an air cylinder of solenoid valve type.
	Solenoid valve mode 2	PIO pattern 5	3 points	In this mode, the output signal is set to the same as the air cylinder auto switch in the solenoid valve mode.
	Force mode 1	PIO pattern 6	32 points	In this mode, you can move to positions under force control in the positioning mode. (Up to 32 positioning points are available.)
	Force mode 2	PIO pattern 7	5 points	In this mode, you can move to positions under force control in the solenoid valve mode. (Up to five positioning points are available.)
Pulse-train control mode	Pulse-train control mode for incremental	PIO pattern 0	-	Position data input to the controller is not necessary, and movement is made according to the sent pulse.
	Pulse-train control mode for absolute	PIO pattern 1		

I/O Signal Table * You can select one of nine types of I/O signal assignments.

Pin No.	Category	Positioning point	Parameter (PIO pattern) selection									
			0	1	2	3	4	5	6	7	0/1	
			Positioning mode 64 points	Teaching mode 64 points	256-point mode 256 points	512-point mode 512 points	Solenoid valve mode 1 7 points	Solenoid valve mode 2 3 points	Force mode 1 32 points	Force mode 2 5 points	Pulse-train mode -	
1A	24V		P24									P24
2A	24V		P24									P24
3A	-		NC									NC
4A	-		NC									NC
5A	Input	IN0	PC1	PC1	PC1	PC1	ST0	ST0	PC1	ST0	SON	
6A		IN1	PC2	PC2	PC2	PC2	ST1	ST1 (JOG+)	PC2	ST1	RES	
7A		IN2	PC4	PC4	PC4	PC4	ST2	ST2 (-)	PC4	ST2	HOME	
8A		IN3	PC8	PC8	PC8	PC8	ST3	-	PC8	ST3	TL	
9A		IN4	PC16	PC16	PC16	PC16	ST4	-	PC16	ST4	CSTP	
10A		IN5	PC32	PC32	PC32	PC32	ST5	-	-	-	DCLR	
11A		IN6	-	MODE	PC64	PC64	ST6	-	-	-	BKRL	
12A		IN7	-	JISL	PC128	PC128	-	-	-	-	RMOD	
13A		IN8	-	JOG+	-	PC256	-	-	CLBR	CLBR	RSTR <small>Note 1</small>	
14A		IN9	BKRL	JOG-	BKRL	BKRL	BKRL	BKRL	BKRL	BKRL	-	
15A		IN10	RMOD	RMOD	RMOD	RMOD	RMOD	RMOD	RMOD	RMOD	-	
16A		IN11	HOME	HOME	HOME	HOME	HOME	-	HOME	HOME	-	
17A		IN12	*STP	*STP	*STP	*STP	*STP	-	*STP	*STP	-	
18A		IN13	CSTR	CSTR/PWRT	CSTR	CSTR	-	-	CSTR	-	-	
19A		IN14	RES	RES	RES	RES	RES	RES	RES	RES	-	
20A		IN15	SON	SON	SON	SON	SON	SON	SON	SON	-	
1B	Output	OUT0	PM1	PM1	PM1	PM1	PE0	LSO	PM1	PE0	PWR	
2B		OUT1	PM2	PM2	PM2	PM2	PE1	LS1 (TRQS)	PM2	PE1	SV	
3B		OUT2	PM4	PM4	PM4	PM4	PE2	LS2 (-)	PM4	PE2	INP	
4B		OUT3	PM8	PM8	PM8	PM8	PE3	-	PM8	PE3	HEND	
5B		OUT4	PM16	PM16	PM16	PM16	PE4	-	PM16	PE4	TLR	
6B		OUT5	PM32	PM32	PM32	PM32	PE5	-	TRQS	TRQS	*ALM	
7B		OUT6	MOVE	MOVE	PM64	PM64	PE6	-	LOAD	LOAD	*EMGS	
8B		OUT7	ZONE1	MODES	PM128	PM128	ZONE1	ZONE1	CEND	CEND	RMDS	
9B		OUT8	PZONE/ZONE2	PZONE/ZONE1	PZONE/ZONE1	PM256	PZONE/ZONE2	PZONE/ZONE2	PZONE/ZONE1	PZONE/ZONE1	ALM1	
10B		OUT9	RMDS	RMDS	RMDS	RMDS	RMDS	RMDS	RMDS	RMDS	ALM2	
11B		OUT10	HEND	HEND	HEND	HEND	HEND	HEND	HEND	HEND	ALM4	
12B		OUT11	PEND	PEND/WEND	PEND	PEND	PEND	-	PEND	PEND	ALM8	
13B		OUT12	SV	SV	SV	SV	SV	SV	SV	SV	*OVLW/*ALML	
14B		OUT13	*EMGS	*EMGS	*EMGS	*EMGS	*EMGS	*EMGS	*EMGS	*EMGS	REND <small>Note 1</small>	
15B		OUT14	*ALM	*ALM	*ALM	*ALM	*ALM	*ALM	*ALM	*ALM	ZONE1	
16B	OUT15	*BALM	*BALM	*BALM	*BALM	*BALM	*BALM	*BALM	*BALM	ZONE2		
17B	-									-		
18B	-									-		
19B	0V					N				N		
20B	0V					N				N		

* In the above table, signals in () represent functions available before the home return.

* In the above table, signals preceded by * are turned OFF while the actuator is operating.

Note 1: It is available to use only in Pulse-Train Control Mode PIO Pattern 1.

Explanation of the I/O Signal Functions

Available signals will differ. Please check the available features in the table below.

Category	Signal abbreviation	Signal name	Description of function
Input	CSTR	PTP strobe (start signal)	The actuator starts moving to the position set by the command position.
	PC1~PC256	Command position number	The position number of the target position is input (binary input).
	BKRL	Forced brake release	The brake is forcibly released.
	RMOD	Operation mode switching	The operation mode can be switched when the MODE switch on the controller is in the AUTO position. (The switch position is AUTO when this signal is OFF, or MANU when the signal is ON.)
	*STP	Pause	The actuator will decelerate to a stop when this signal turns OFF while the actuator is moving. The remaining movement will be suspended while the actuator is stopped and the movement will resume once the signal turns ON.
	RES	Reset	The alarm will be reset when the signal turns ON. The remaining travel can be canceled by turning this signal ON while the actuator is paused (*STP is OFF).
	SON	Servo ON	The servo is ON while this signal is ON, and remains OFF while this signal is OFF.
	HOME	Home return	When this signal turns ON, the actuator performs home return operation.
	MODE	Teaching mode	When this signal turns ON, the actuator switches to the teaching mode. (Switching will not occur if CSTR, JOG+ and JOG- are all OFF and the actuator is still moving.)
	JISL	Jog/inch switching	When this signal turns OFF, the actuator can be jogged with JOG+ and JOG-. When the signal is ON, the actuator can be inched with JOG+ and JOG-.
	JOG+, JOG-	Jog	When the JISL signal is OFF, the actuator jogs in the positive direction upon detection of the ON edge of the JOG+ signal, or in the negative direction upon detection of the ON edge of the JOG- signal. The actuator decelerates to a stop if the OFF edge is detected while jogging in each direction. The actuator operates by inching when the JISL signal is ON.
	PWRT	Current position write	In the teaching mode, specify a position and then turn this signal ON for at least 20ms, and the current position will be written to the specified position.
	ST0~ST6	Start signal	In the solenoid valve mode, the actuator moves to the specified position when this signal turns ON. (The start signal is not required.)
	CLBR	Load cell calibration command	Load cell calibration starts when this signal has remained ON for at least 20ms.
	TL	Torque limit selection signal	The motor torque is limited by the value set in the parameter while the signal is on. TLR signal turns on once the torque reaches the set value. (Pulse train mode only)
	CSTP	Forced stop	The actuator is stopped compulsorily if the signal is kept on for 10ms or more. The actuator decelerates and stops with the torque set inside the controller, and then the servo gets turned off. (Pulse train mode only)
DCLR	Deviation counter clear signal	The position deviation counter is continuously cleared while this signal is on. (Pulse train mode only)	
RSTR*1	Datum position movement command	Turn it on and the movement will be made to the position set in Parameter No. 167. *1: Used only in PIO Pattern 1.	
Output	PEND/INP	Positioning complete	This signal turns ON when the actuator enters the in-position band after movement. If the actuator exceeds the in-position band, the PEND signal does not turn OFF, but the INP signal turns OFF. PEND and INP can be switched using a parameter.
	PM1~PM256	Complete position number	The position number of the position reached at the end of positioning is output (binary output).
	HEND	Home return completion	This signal turns ON upon completion of home return.
	ZONE1, ZONE2	Zone	This signal turns ON if the current actuator position is within the range set by the parameters.
	PZONE	Position zone	This signal turns ON when the current actuator position is within the range set in the position data table after position movement. This signal can be used with ZONE1/ZONE2, but PZONE becomes effective only when moving to a specified position.
	RMDS	Operation mode status output	The operation mode status is output. This signal turns ON when the controller is in the manual mode.
	*OVLW	Overload warning	This signal is ON in a normal condition, and turns OFF when the overload warning level is exceeded. (Operation will continue.)
	*ALML	Minor failure alarm	This signal is ON in a normal condition, and turns OFF when a message-level alarm occurs. (Operation will continue.)
	*ALM	Alarm	This signal is ON when the controller is in a normal condition, and turns OFF when an alarm occurs.
	ALM1~ALM8	Alarm code output signal	Content of an alarm code is output in binary code when an alarm is generated. (Pulse-train mode only)
	MOVE	Moving	This signal is ON while the actuator is moving (also during home return and push-motion operation).
	SV	Servo ON	This signal is ON while the servo is ON.
	*EMGS	Emergency stop output	This signal is ON when no emergency stop is actuated on the controller, and turns OFF when an emergency stop is actuated.
	*BALM	Absolute battery voltage low warning	If the controller is of the absolute specification, this signal turns OFF when the voltage of the absolute battery drops. (Operation will continue.)
	MODES	Teaching mode output	This signal turns ON when the actuator enters the teaching mode via MODE signal input. It turns OFF once the actuator returns to the normal mode.
	WEND	Write complete	This signal is OFF immediately after switching to the teaching mode, and turns ON once writing is completed according to the PWRT signal. When the PWRT signal turns OFF, this signal also turns OFF.
	PE0~PE6	Current position number	This signal turns ON when the actuator has completed moving to the target position in the solenoid valve mode.
	LS0~LS2	Limit switch output	This signal turns ON when the current actuator position enters the in-position band set before and after the target position. If the home return has already completed, this signal is output even before a movement command is issued or while the servo is OFF.
	CEND	Load cell calibration complete	This signal turns ON upon completion of load cell calibration. When the CLBR signal turns OFF, this signal also turns OFF.
	LOAD	Load output judgment signal	During push-motion operation, this signal is output when the current value set for the "threshold" is exceeded within the range of "Zone+" and "Zone-" set in the position data table. The signal is used to determine if press-fitting action has been performed correctly.
TRQS	Torque level output	This signal is output when the motor current reaches the current value set for the "threshold" in the position data table after the slider (rod) has collided with an obstacle, etc., during movement in push-motion operation.	
PWR	System ready	It turns on when the startup is successfully finished after the power is supplied to the controller. (Pulse-train mode only)	
TLR	Torque limited signal	This signal turns on upon reaching the torque limit while the torque is limited by TL Signal. (Pulse-train mode only)	
REND*1	Reference position movement complete	It turns on once the movement to the position set in Parameter No. 167 is complete. *1: Used only in PIO Pattern 1	

* In the above table, signals preceded by * are normally ON and turn OFF while the actuator is operating.

I/O Wiring Diagrams

Positioning Mode/Teaching Mode/ Solenoid Valve Mode

PIO connector (NPN specification)

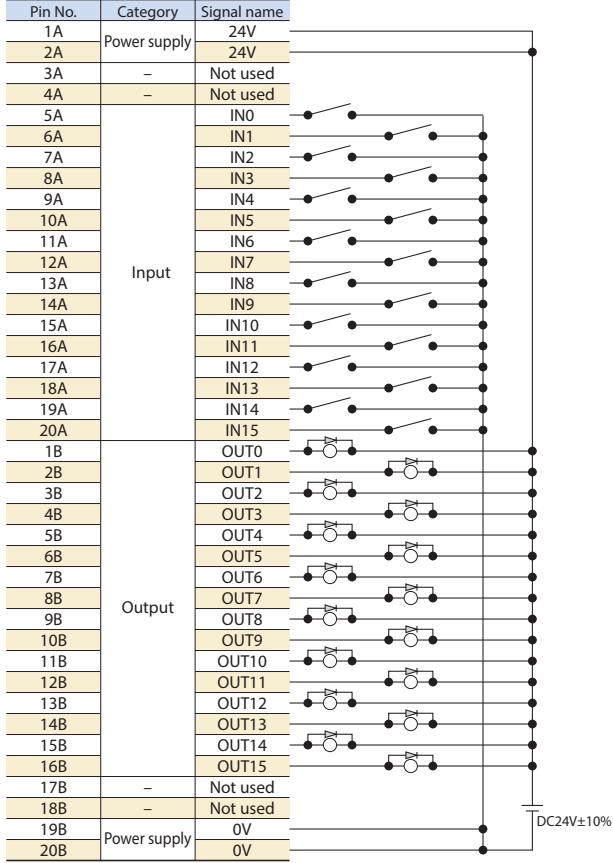

* Connect Pins 1A and 2A to 24V, and Pins 19B and 20B to 0V.

Pulse-train Mode (Differential Output)

Pulse connector

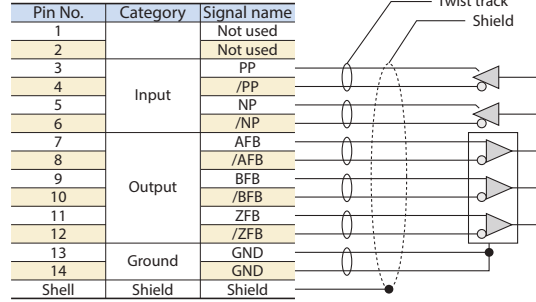

PIO connector (NPN specification)

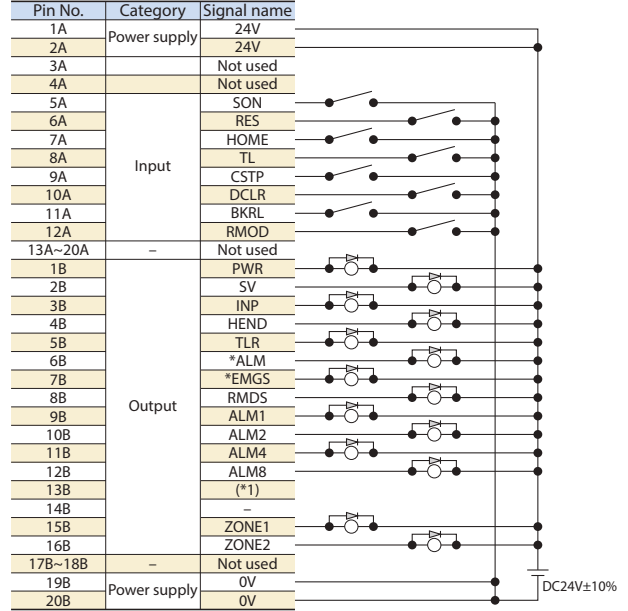

* Please make sure to connect the Shield of the twisted pair cable, which connects to the Pulse connector, to the Shell. Also **keep the cable length to 10m or less**.

* Connect Pins 1A and 2A to 24V, and Pins 19B and 20B to 0V

(*1)-*/ALML*/OVLW*/BALM (switchable with parameters)

PIO Input and Output Interface

Input Part External Input Specifications

Item	Specification
Input voltage	DC24V ±10%
Input current	4mA/1 circuit
ON/OFF voltage	ON voltage: DC 18V min. OFF voltage: DC 6V max.
Isolation method	Photocoupler

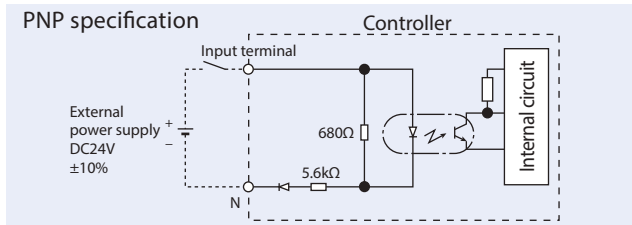
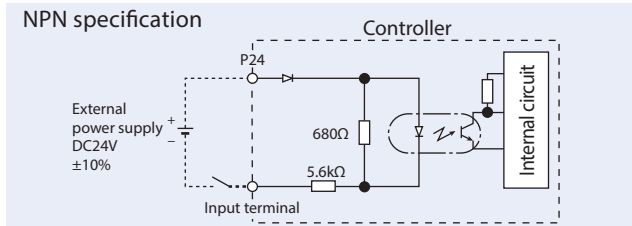

Output Part External Output Specifications

Item	Specification
Load voltage	DC24V
Max. load current	50mA/1 point
Leak current	0.1mA max./1 point
Isolation method	Photocoupler

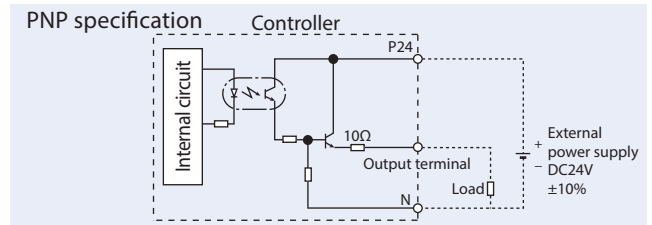
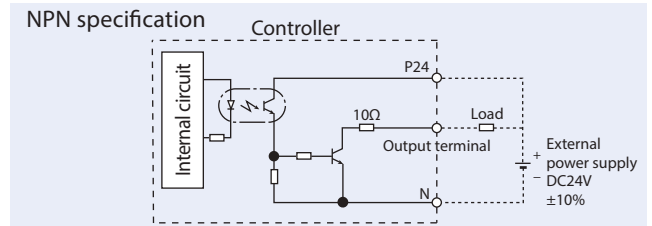

Pulse-train Type I/O Specification (Differential Line Driver Specification)

Input Part

Maximum number of input pulses: Line driver interface 2.5Mpps
Isolation method: Photocoupler isolation

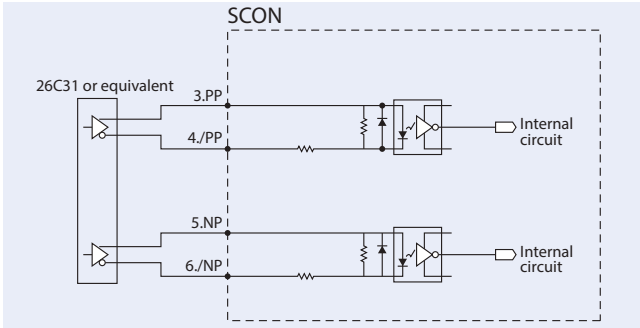

Output Part

Maximum number of output pulses: Line driver interface 2.5Mpps
Isolation/non-isolation: Non-isolation

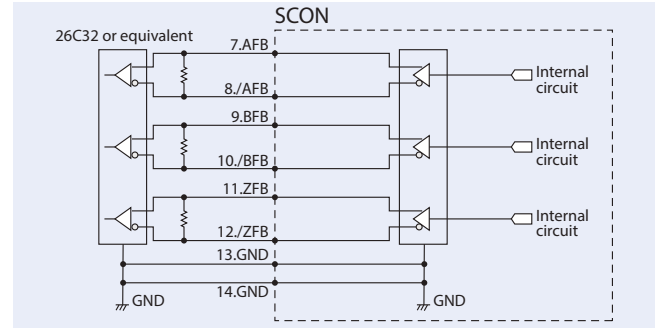

Pulse-train Type I/O Specification (Open-collector Specification)

The AK-04 (Option) is needed to input pulses. The JM-08 (Option) is needed to output pulses.

Maximum number of input pulses:
200kpps (AK-04 required)
Maximum number of output pulses:
500kpps (JM-08 required)

- * The DC24V power supply connected to the AK-04 must be shared with the PIO interface.
- * Keep the length of the cable connecting the pulse output unit (PLC) and AK-04/JM-08 as short as possible.
- Also keep the cable between the AK-04/JM-08 and PULSE connector to 2m or less.

Note

Use the same power supply for open-collector input/output to/from the host and for the AK-04, JM-08.

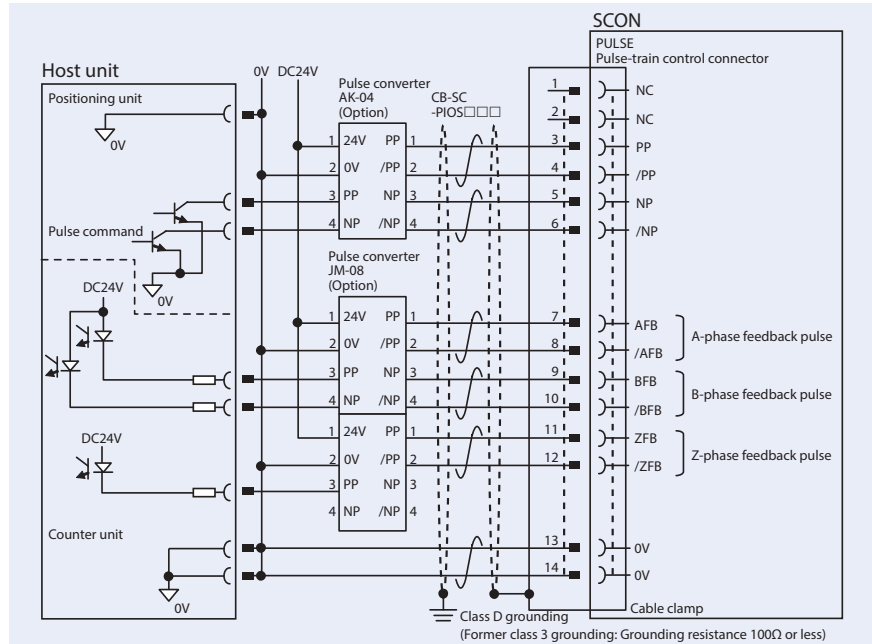

Command Pulse Input Patterns

Command pulse-train pattern	Input terminal	Forward	Reverse	
Forward pulse-train	PP•/PP			
Reverse pulse-train	NP•/NP			
A forward pulse-train indicates the amount of motor rotation in the forward direction, while a reverse pulse-train indicates the amount of motor rotation in the reverse direction.				
Negative logic	Pulse-train			
	Sign	Low	High	
	The command pulse is used for the amount of motor rotation, while the sign indicates the rotating direction.			
Phase A/B pulse-train	PP•/PP			
	NP•/NP			
Command phases A and B having a 90° phase difference (multiplier is 4) indicate the amount of rotation and the rotating direction.				
Positive logic	Forward pulse train	PP•/PP		
	Reverse pulse-train	NP•/NP		
	Pulse-train	PP•/PP		
	Sign	NP•/NP	High	Low
	Phase A/B pulse-train	PP•/PP		
NP•/NP				

Specification Table

Item	Specification	
Applicable motor capacity	Less than 400W	400W or more
Number of controlled axes	1 axis	
Operation method	Positioner type/pulse-train type	
Number of positioning points	512 points (PIO specification), 768 points (fieldbus specification)	
Backup memory	Non-volatile memory (FRAM)	
I/O connector	40-pin connector	
Number of I/O points	16 input points/16 output points	
I/O power supply	External supply DC24V ±10%	
Serial communication	RS485 1ch	
Command pulse-train input method (Note 1)	Differential line driver output supported	
Maximum input pulse frequency	Differential line driver method: 2.5Mpps max./Open-collector method (pulse converter used): 200kpps max.	
Position detection method	Incremental encoder / Absolute encoder / Quasi-absolute serial encoder / Battery-less absolute encoder	
Driving power shut-off function	CB: Available (built-in relay) CGB: Unavailable	
Forced electromagnetic brake release	Brake release switch ON/OFF	
Input power supply	Single-phase AC100~115V±10% Single-phase AC200~230V±10%	Single-phase AC200~230V±10%
Power-supply capacity (Note 2)	12W / 89VA 20W / 74VA 30W (other than RS) / 94VA 30W (RS) / 186VA 60W (other than RCS3-CTZ5C) / 186VA 60W (RCS3-CTZ5C) / 245VA 100W / 282VA 150W / 376VA 200W / 469VA	100SW (LSA/LSAS-N10) ^(*) / 331VA 200SW (LSA-S10H, LSA/LSAS-N15S) ^(*) / 534VA 200SW (LSA/LSAS-N15H) ^(*) / 821VA 300W (LSA-N19) ^(*) / 710VA 400W (other than RCS3-CT8C) / 968VA 400W (RCS3-CT8C) / 1278VA 600W / 1212VA 750W / 1569VA
Vibration resistance	X,Y,and Z directions, 10~57Hz single-side width 0.035mm (continuous), 0.075mm (intermittent) 58~150Hz 0.5G (continuous), 1G (intermittent)	
Calendar/ clock function	Retention time	Approx. 10 days
	Charge time	Approx. 100 hours
Protective functions	Overcurrent, abnormal temperature, low fan speed monitoring, encoder disconnection, etc.	
Ambient operating temperature	0~40°C	
Ambient operating humidity	85%RH or less (non-condensing)	
Operating atmosphere	Free from corrosive gases	
Protection degree	IP20	
Mass	Approx. 900g (+ 25g for the absolute specification)	Approx. 1.2kg (+ 25g for the absolute specification)
External dimensions	58mm (W) × 194mm (H) × 121mm (D)	72mm (W) × 194mm (H) × 121mm (D)

(Note 1) For the command pulse input method, use the differential line driver method resistant to noise. If the open-collector method must be used, use the optional pulse converter (AK-04/JM-08) to convert open-collector pulses to differential pulses.

(Note 2) Controllers operating any of the actuator models denoted by (*) shall conform to the external dimensions of controllers for 400W or more, even when the output is less than 400W.

* The number of encoder pulses for the actuators operable with SCON-CB is 3072 pulses for RCS2-SRA7BD/SRG57BD/SRGD7BD, 1600 pulses for RCS2-□□5N (Incremental), 1048576 pulses for DD-□18P:20bit, 131072 pulses for DD-□18S:17bit, 2400 pulses for NS-S□M□ (Incremental) and 16384 pulses for all other models.

External Dimensions

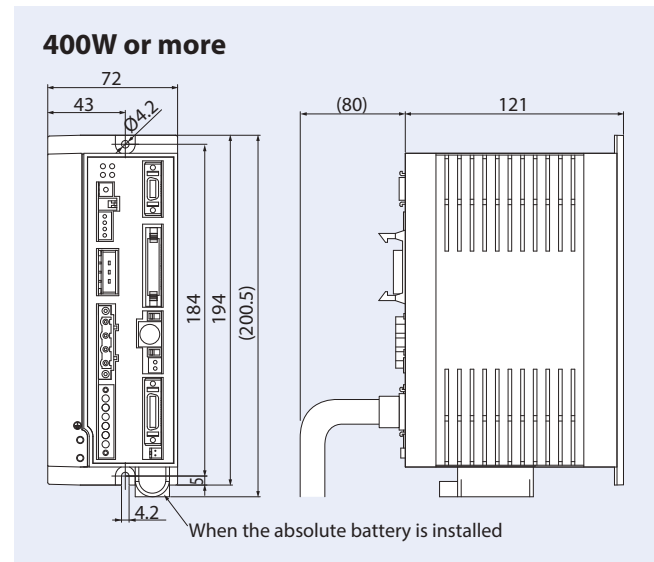
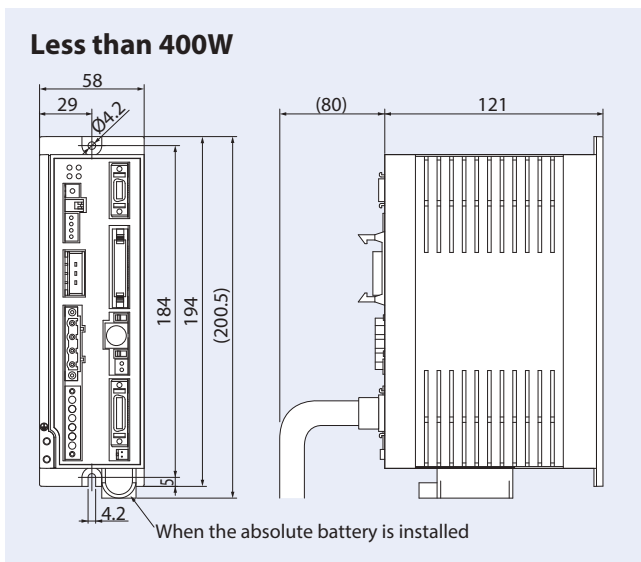

Name of Each Part

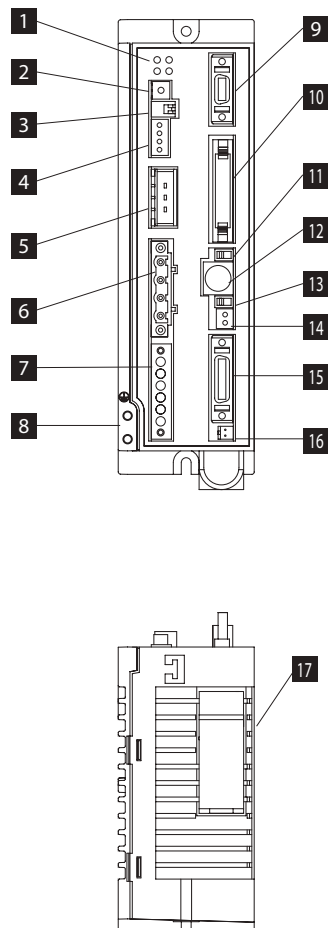

1 LED display

It displays the controller status.

Name	Color	Function description
PWR	Green	Turns on when system is ready (after power turned on, CPU in normal function)
SV	Green	Turns on when servo is on
ALM	Orange	Turns on when alarm issued
EMG	Red	Turns on while in emergency stop

2 Rotary switch

The address setting switch for identifying each controller when they are linked

3 Piano switch

The controller systems switch.

Name	Function description
1	Operation mode changeover switch OFF: Positioner mode ON: Pulse-train control mode * Valid when power is turned on
2	For manufacturer tuning, always off

4 System I/O connector

The connector for the emergency stop switch etc.

5 Regenerative unit connector

The connector for regenerative units which absorb the regenerative current generated when the actuator decelerates and stops.

6 Motor connector

The actuator motor cable connector.

7 Power supply connector

The AC power connector. Divided into controller power input and motor power input.

8 Grounding terminal

The protective grounding screw. Please make sure to secure grounding.

9 Connector for pulse-train control

It is a connector used in the operation in Pulse-Train Control Mode. Feedback pulse is valid also in Positioner Mode.

10 PIO connector

The connector for the cable for parallel communications with the PLC and other peripheral devices.

11 Operation mode selection switch

Name	Function description
MANU	Does not accept PIO commands
AUTO	Accepts PIO commands

* The emergency stop switch on the teaching pendant becomes effective as soon as it is connected regardless of AUTO or MANU. Also, turn the power off before disconnecting the teaching pendant or SIO communication cable.

12 SIO connector

The connector for the teaching pendant or the PC communications cable.

13 Brake release switch

The forced release switch for the electromagnetic brake integrated with an actuator.

* It is necessary that 24V DC power supply for brake drive is connected.

14 Brake power supply connector

The connector for supplying DC24V power to the brake. (necessary only when brake-equipped actuator is connected).

15 Encoder / Sensor connector

The encoder/sensor cable connector.

16 Absolute battery connector

The connector for the absolute data backup battery (necessary only for absolute encoder type).

17 Absolute battery holder

It is a battery holder in order to mount the absolute data backup battery.

Options

Teaching Pendant

■ Features Teaching device offering position input, test operation, monitoring and other functions.

■ Model **TB-01-C**

■ Specification

Rated voltage	DC24V
Power consumption	3.6W or less (150mA or less)
Ambient operating temperature	0~50°C
Ambient operating humidity	20~85%RH (non-condensing)
Environmental resistance	IP40 (initial state)
Mass	507g (TB-01-N only)

■ Configuration

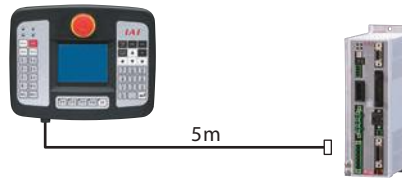

■ External dimensions

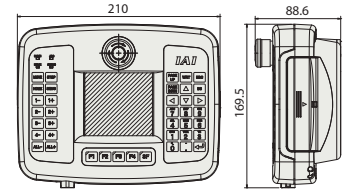

PC Compatible Software(Windows Only)

■ Features This startup support software provides functions to input positions, perform test operations and monitor data, among others. Incorporating all functions needed to make adjustments, this software helps shorten the initial startup time.

XP SP2 or later/Vista/7/8

■ Model **RCM-101-MW**

(Includes an external device communication cable and an RS232 conversion unit)

■ Configuration

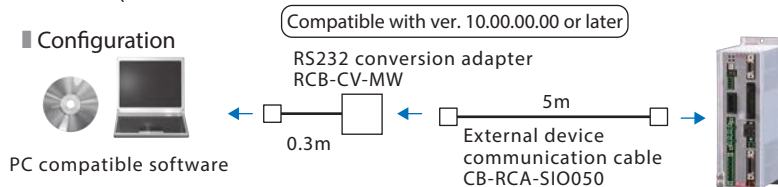

■ Model **RCM-101-USB**

(Includes an external device communication cable, USB conversion adapter and USB cable)

■ Configuration

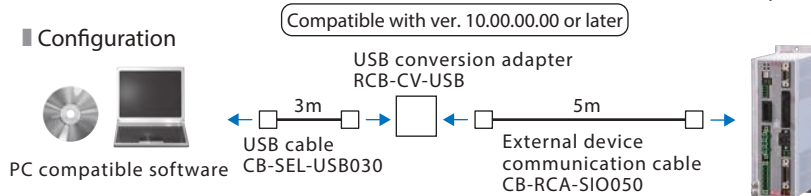

Regenerative Resistance Unit

■ Features This unit converts the regenerative current, which is generated when the motor decelerates, into heat. Please refer to the tables below to confirm the total wattage of the actuators, and use the regenerative unit as necessary.

* If two regenerative units are required, arrange one RESU(D)-2 and one RESU(D)-1. (Please contact IAI for the details)

■ Model **RESU-2** (Standard specification)
RESUD-2 (DIN rail mounting specification)

■ Specification

Model	RESU-2	RESUD-2
Unit mass	Approx. 0.4kg	
Built-in regenerative resistor	235Ω 80W	
Mounting method	Screw mounting	DIN rail mounting
Supplied cable	CB-SC-REU010	

■ Necessary Amount Guideline

	Horizontal	Vertical
0	~100W	~100W
1	~400W	~400W
2	~750W	~750W

* The required regenerative resistance may be more than as specified above depending on the operating conditions.

■ Necessary Amount Guideline (RCS2-RA13R)

	Lead 2.5	Lead 1.25
Horizontal	1	0
Vertical	1	1

* The required regenerative resistance may be more than as specified above depending on the operating conditions.

■ External dimensions

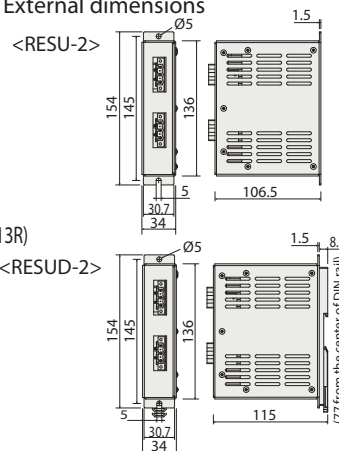

Absolute Data Backup Battery

■ Features This is an absolute data backup battery for an actuator with absolute specification.

■ Model **AB-5(battery only)**
AB-5-CS(with a case)



Maintenance Parts

When replacing a cable after purchasing the product, please refer to the list of models below

Model Number	CB-RCC-MA □□□□	Motor Cable	for RCS2/RCS3
	CB-RCC-MA □□□□-RB	Motor Robot Cable	

*Please indicate the cable length (L) in □□□ (e.g. 080=8m). Maximum length = 30m

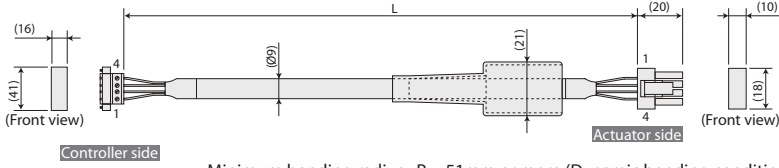

Wire	Color	Signal	No.	Signal	Color	Wire
0.75sq	Green	PE	1	1	U	Red
	Red	U	2	2	V	White
	White	V	3	3	W	Black
	Black	W	4	4	PE	Green

Minimum bending radius R = 51mm or more (Dynamic bending condition)

*The robot cable is designed for flex-resistance. Please use the robot cable if the cable has to be installed through the cable track.

Model Number	CB-XMC-MA □□□□	Motor Cable	for LSA Large Type
--------------	----------------	-------------	--------------------

*Please indicate the cable length (L) in □□□ (e.g. 080=8m). Maximum length: SCON/SSEL = 20m, XSEL = 30m

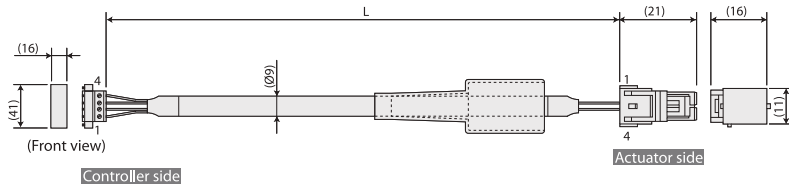

Wire	Color	Signal	No.	No.	Signal	Color	Wire
1.25sq	Green	PE	1	1	U	Red	1.25sq (crimped)
	Red	U	2	2	V	White	
	White	V	3	3	W	Black	
	Black	W	4	4	PE	Green	

Minimum bending radius R = 55mm or more (Dynamic bending condition)

* Only robot cable is available for this model.

Model Number	CB-RCS2-PA □□□□	Encoder Cable	for RCS2/RCS3
	CB-X3-PA □□□□	Encoder Robot Cable	

* Please indicate the cable length (L) in □□□ (e.g. 080=8m). Maximum length = 30m

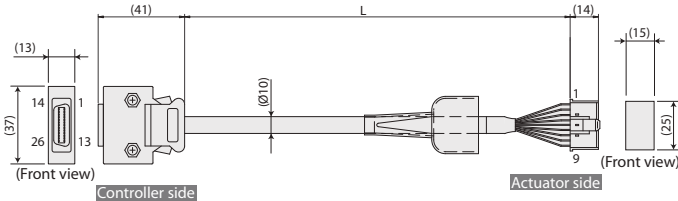

Wire	Color	Signal	No.	No.	Signal	Color	Wire
-	-	-	10	1	A	White/Blue	AWG26 (crimped)
-	-	-	11	2	A	White/Yellow	
-	-	E24V	12	3	B	White/Red	
White/Green	OV	13	4	B	White/Black		
White/Orange	LS	26	5	Z	White/Purple		
-	CREEP	25	6	Z	White/Gray		
-	OT	24	7	LS+	White/Orange		
-	RSV	23	8	-	-		
-	-	9	9	-	-		
-	-	18	10	SD	Ground		
-	-	19	11	SD	Orange		
White/Blue	A+	1	12	SD	Green		
White/Yellow	A-	2	13	BAT+	Purple		
White/Red	B+	3	14	BAT-	Gray		
White/Black	B-	4	15	VCC	Red		
White/Purple	Z+	5	16	VCC	Red		
White/Gray	Z-	6	17	GND	Black		
Orange	SRD+	7	18	LS	White/Green		
Green	SRD-	8	19	BK-	Blue		
Purple	BAT+	14	20	BK+	Yellow		
Gray	BAT-	15	21	-	-		
Red	VCC	16	22	-	-		
Black	GND	17	-	-	-		
Blue	BKR-	20	-	-	-		
Yellow	BKR+	21	-	-	-		
-	-	22	-	-	-		

Minimum bending radius R = 58mm or more (Dynamic bending condition)

*The robot cable is designed for flex-resistance. Please use the robot cable if the cable has to be installed through the cable track.

Model Number	CB-RCS2-PLLA □□□□	Encoder Cable	for RCS2-RA13R with Load Cell
	CB-RCS2-PLLA □□□□-RB	Encoder Robot Cable	

* Please indicate the cable length (L) in □□□ (e.g. 080=8m). Maximum length = 30m

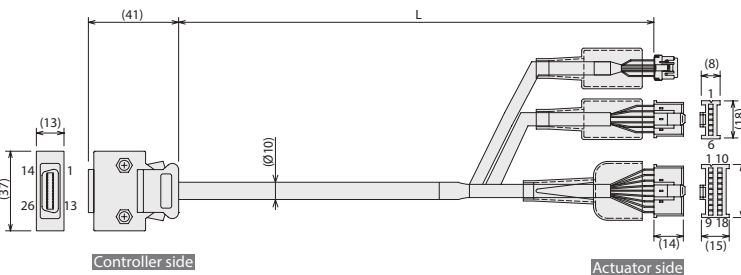

Wire	Signal	No.	No.	Signal	Wire
-	-	-	1	SGA	AWG26 (crimped)
-	-	-	2	SGB	
-	-	-	3	VIN	
-	-	-	4	GND	
-	-	-	5	FG	
-	-	-	6	-	AWG26 (crimped)
E24V	12	1	1	A	
OV	13	2	2	A	
LS	26	3	3	B	
CLEEP	25	4	4	B	
OT	24	5	5	Z	
RSV	23	6	6	Z	
LC SRD+	9	7	7	-	
LC SRD-	10	8	8	-	
LC VCC	18	9	9	FG	
LC GND	19	10	10	SD	
A+	1	11	11	SD	
A-	2	12	12	BAT+	
B+	3	13	13	BAT-	
B-	4	14	14	VCC	
Z+	5	15	15	VCC	
Z-	6	16	16	GND	
SRD+	7	17	17	BK-	
SRD-	8	18	18	BK+	
BAT+	14	-	-	-	
BAT-	15	-	-	-	
VCC	16	-	-	-	
GND	17	-	-	-	
BKR-	20	-	-	-	
BKR+	21	-	-	-	
-	-	22	-	-	

*The robot cable is designed for flex-resistance. Please use the robot cable if the cable has to be installed through the cable track.

Maintenance Parts

When replacing a cable after purchasing the product, please refer to the list of models below.

Model Number	CB-RCS2-PLA <input type="checkbox"/> <input type="checkbox"/> <input type="checkbox"/>	Encoder Cable	for RCS2 Rotary Type
	CB-X2-PLA <input type="checkbox"/> <input type="checkbox"/> <input type="checkbox"/>	Encoder Robot Cable	

* Please indicate the cable length (L) in (e.g. 080=8m). Maximum length = 30m

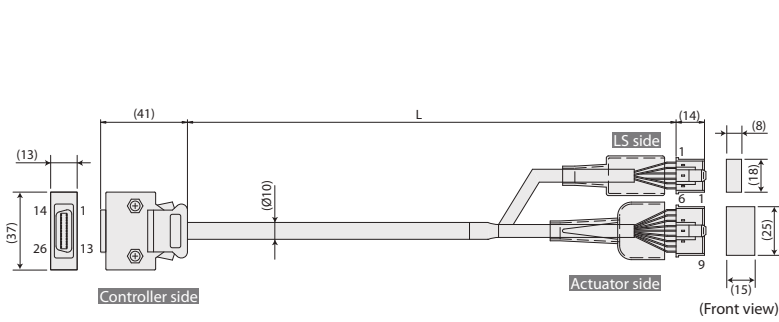

Minimum bending radius R = 58mm or more (Dynamic bending condition)

*The robot cable is designed for flex-resistance. Please use the robot cable if the cable has to be installed through the cable track.

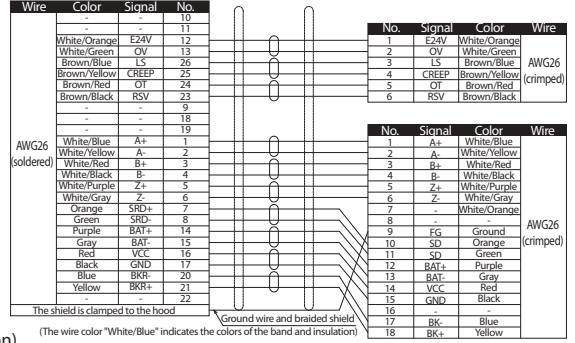

Model Number	CB-X-MA <input type="checkbox"/> <input type="checkbox"/> <input type="checkbox"/>	Motor Cable	for Models Other than RCS2/RCS3
--------------	--	-------------	------------------------------------

* Please indicate the cable length (L) in (e.g. 080=8m). Maximum length = 30m

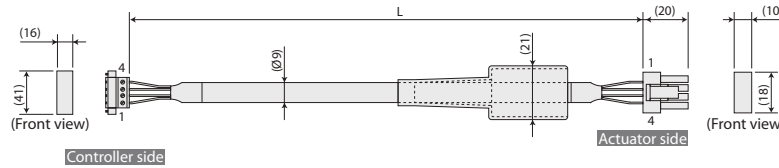

Minimum bending radius R = 51mm or more (Dynamic bending condition)

* Only robot cable is available for this model.

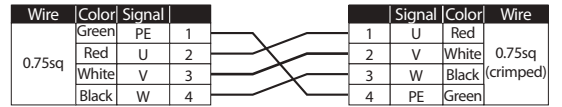

Model Number	CB-X1-PA <input type="checkbox"/> <input type="checkbox"/> <input type="checkbox"/>	Encoder Cable	for Models Other than NS/ RCS2/RCS3
--------------	---	---------------	--

* Please indicate the cable length (L) in (e.g. 080=8m). Maximum length = 30m

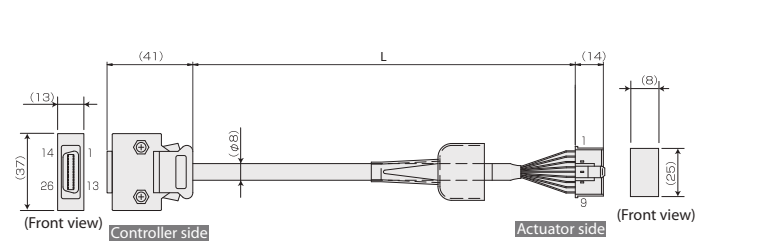

Minimum bending radius R = 44mm or more (Dynamic bending condition)

* Only robot cable is available for this model.

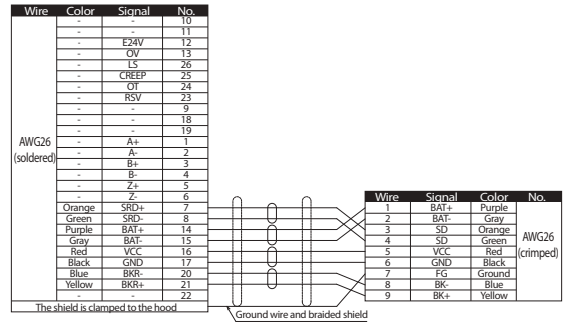

Model Number	CB-X1-PLA <input type="checkbox"/> <input type="checkbox"/> <input type="checkbox"/>	Encoder Cable	for Models with LS Option Other than RCS2/RCS3
--------------	--	---------------	---

* Please indicate the cable length (L) in (e.g. 080=8m). Maximum length = 30m

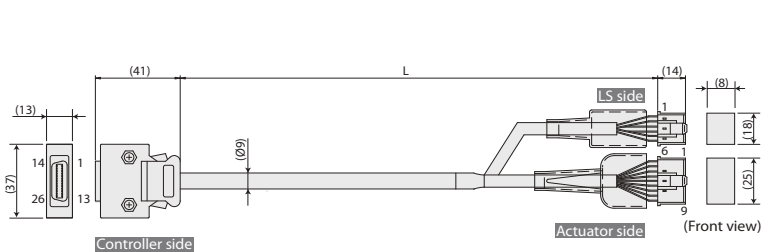

Minimum bending radius R = 54mm or more (Dynamic bending condition)

* Only robot cable is available for this model.

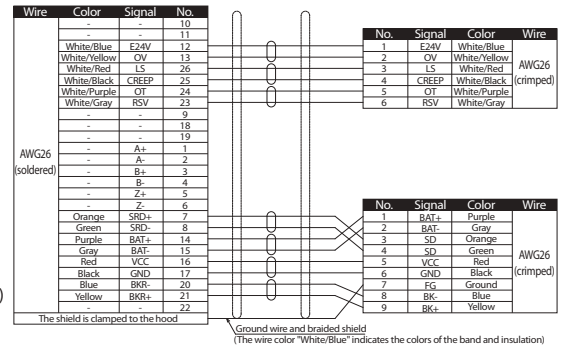

Model Number **CB-XEU-MA** □□□ **Motor Cable** for IS(P)WA

*Please indicate the cable length (L) in □□□ (e.g. 080=8m). Maximum length = 30m

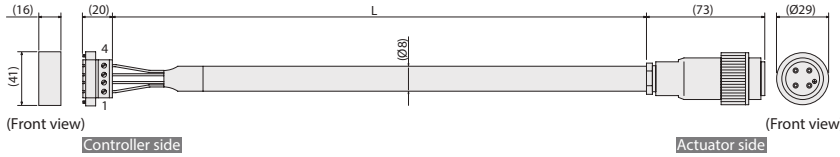

Plug GIC2.5/4-STF-7.62 (Phoenix)			Plug connector 99-4222-00-04 (BINDER)		
Wire	Signal	No.	No.	Signal	Wire
0.75sq	PE	1	1	PE	0.75sq (crimped)
	U	2	2	U	
	V	3	3	V	
	W	4	4	W	

Minimum bending radius R = 48mm or more (Dynamic bending condition)

* Only robot cable is available for this model.

Model Number **CB-X1-PA** □□□-WC **Encoder Cable** for IS(P)WA

*Please indicate the cable length (L) in □□□ (e.g. 080=8m). Maximum length = 30m

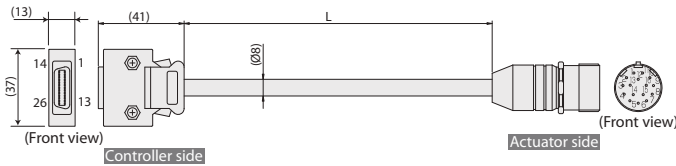

Wire	Color	Signal	No.
-	-	-	10
-	-	-	11
-	E24V	-	12
-	OV	-	13
-	LS	-	26
-	CREEP	-	25
-	OT	-	24
-	RSV	-	23
-	-	-	9
-	-	-	18
-	-	-	19
-	A+	-	1
-	A-	-	2
-	B+	-	3
-	B-	-	4
-	Z+	-	5
-	Z-	-	6
-	SRD+	-	7
-	SRD-	-	8
Green	BAT+	-	14
Purple	BAT-	-	15
Gray	BAT-	-	15
Red	VCC	-	16
Black	GND	-	17
Blue	BKR-	-	20
Yellow	BKR+	-	21
-	-	-	22

No.	Signal	Color	Wire
1	SD	Orange	AWG26 (crimped)
2	SD	Green	
3	-	-	
4	-	-	
5	-	-	
6	-	-	
7	-	-	
8	-	-	
9	-	-	
10	VCC	Red	
11	GND	Black	
12	BAT+	Purple	
13	BAT-	Gray	
14	-	-	
15	BK-	Blue	
16	BK+	Yellow	

The shield is clamped to the hood. The shield is connected to metal sleeve. Ground wire and braided shield. (The wire color "White/Blue" indicates the colors of the band and insulation.)

Minimum bending radius R = 44mm or more (Dynamic bending condition)

* Only robot cable is available for this model.

Model Number **CB-PAC-PIO** □□□ **I/O Flat Cable** for SCON-CB

*Please indicate the cable length (L) in □□□ (e.g. 080=8m). Maximum length = 10m

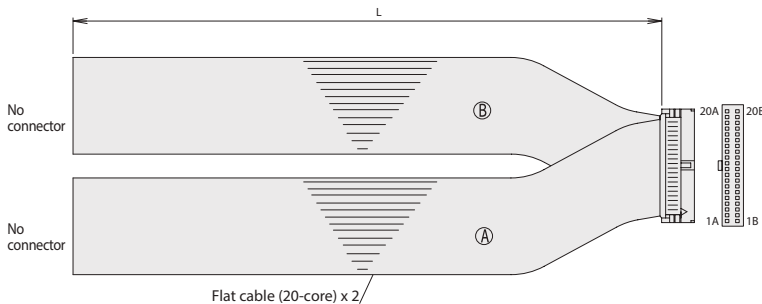

No.	Signal	Color	Wire	No.	Signal	Color	Wire
1A	24V	Brown-1	Flat cable @ (crimped)	1B	OUT0	Brown-3	Flat cable @ (crimped) AWG28
2A	24V	Red-1		2B	OUT1	Red-3	
3A	-	Orange-1		3B	OUT2	Orange-3	
4A	-	Yellow-1		4B	OUT3	Yellow-3	
5A	IN0	Green-1		5B	OUT4	Green-3	
6A	IN1	Blue-1		6B	OUT5	Blue-3	
7A	IN2	Purple-1		7B	OUT6	Purple-3	
8A	IN3	Gray-1		8B	OUT7	Gray-3	
9A	IN4	White-1		9B	OUT8	White-3	
10A	IN5	Black-1		10B	OUT9	Black-3	
11A	IN6	Brown-2		11B	OUT10	Brown-4	
12A	IN7	Red-2		12B	OUT11	Red-4	
13A	IN8	Orange-2		13B	OUT12	Orange-4	
14A	IN9	Yellow-2		14B	OUT13	Yellow-4	
15A	IN10	Green-2		15B	OUT14	Green-4	
16A	IN11	Blue-2		16B	OUT15	Blue-4	
17A	IN12	Purple-2		17B	-	Purple-4	
18A	IN13	Gray-2		18B	-	Gray-4	
19A	IN14	White-2		19B	OV	White-4	
20A	IN15	Black-2		20B	OV	Black-4	

Model Number **CB-SC-PIOS** □□□ **SCON Pulse-train Control Cable** for SCON-CB

*Please indicate the cable length (L) in □□□ (e.g. 080=8m). Maximum length = 10m

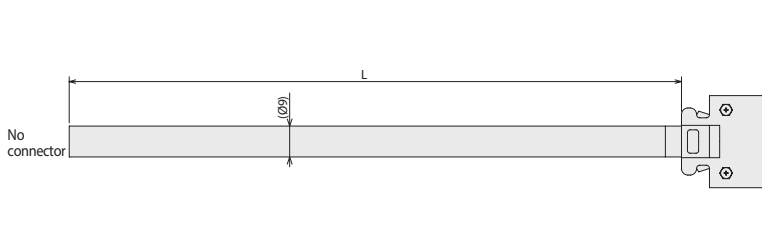

Wire	Color	Signal	No.
Black	Black	Not used	1
White/Black	White/Black	Not used	2
Red	Red	PP	3
White/Red	White/Red	/PP	4
Green	Green	NP	5
White/Green	White/Green	/NP	6
Yellow	Yellow	AFB	7
White/Yellow	White/Yellow	/AFB	8
Brown	Brown	BFB	9
White/Brown	White/Brown	/BFB	10
Blue	Blue	ZFB	11
White/Blue	White/Blue	/ZFB	12
Gray	Gray	GND	13
White/Gray	White/Gray	GND	14

0.2sq (soldered). The shield is connected to cable clamp.

IAI America, Inc.

Headquarters: 2690 W. 237th Street, Torrance, CA 90505 (800) 736-1712

Chicago Office: 110 E. State Pkwy, Schaumburg, IL 60173 (800) 944-0333

Atlanta Office: 1220 Kennestone Circle, Suite 108, Marietta, GA 30066 (888) 354-9470

www.intelligentactuator.com

IAI Industrieroboter GmbH

Ober der Röth 4, D-65824 Schwalbach am Taunus, Germany

IAI (Shanghai) Co., Ltd.

SHANGHAI JIAHUA BUSINESS CENTER A8-303,808,
Hongqiao Rd. Shanghai 200030, China

IAI Robot (Thailand) Co., Ltd.

825 PhairojKijja Tower 12th Floor, Bangna-Trad RD.,
Bangna, Bangna, Bangkok 10260, Thailand