

ICSA3-BA **MB1**

Cartesian Robot: X-Y-Z 3-Axes Configuration
Z-axis Base Mount Type

ICSPA3-BA **MB1**

Cartesian Robot: X-Y-Z 3-Axes Configuration
Z-axis Base Mount Type **High-Precision Specification**

Type XYB + Z-axis Base Mount Type Stroke X-axis: 100-600mm Y-axis: 100-400mm Z-axis: 100-300mm Load capacity 13kg ~ 1.7kg

Model specification items Series Type Encoder type X-axis stroke + options Y-axis stroke + options Z-axis stroke + options Applicable controller Cable length Cable management
(Example) ICSA3 [ICSPA3] - BA1MB1M - A - 60AQL - 40AQL - 30BL - T1 - 5L - SC - SC

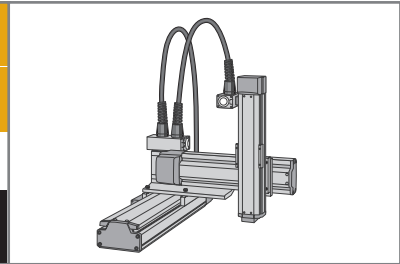

* Refer to page 51 for the details of model specification items.

Models/Specifications * [] is for the high-precision specification.

Encoder Type	XY-axis configuration direction (*1)	Z-axis type (*2)	Model
Absolute	1	H	ICSA3 [ICSPA3] -BA1MB1H-A- <input type="checkbox"/> - <input type="checkbox"/> - <input type="checkbox"/> -B-T1- <input type="checkbox"/> - <input type="checkbox"/>
		M	ICSA3 [ICSPA3] -BA1MB1M-A- <input type="checkbox"/> - <input type="checkbox"/> - <input type="checkbox"/> -B-T1- <input type="checkbox"/> - <input type="checkbox"/>
		L	ICSA3 [ICSPA3] -BA1MB1L-A- <input type="checkbox"/> - <input type="checkbox"/> - <input type="checkbox"/> -B-T1- <input type="checkbox"/> - <input type="checkbox"/>
	2	H	ICSA3 [ICSPA3] -BA2MB1H-A- <input type="checkbox"/> - <input type="checkbox"/> - <input type="checkbox"/> -B-T1- <input type="checkbox"/> - <input type="checkbox"/>
		M	ICSA3 [ICSPA3] -BA2MB1M-A- <input type="checkbox"/> - <input type="checkbox"/> - <input type="checkbox"/> -B-T1- <input type="checkbox"/> - <input type="checkbox"/>
		L	ICSA3 [ICSPA3] -BA2MB1L-A- <input type="checkbox"/> - <input type="checkbox"/> - <input type="checkbox"/> -B-T1- <input type="checkbox"/> - <input type="checkbox"/>
	3	H	ICSA3 [ICSPA3] -BA3MB1H-A- <input type="checkbox"/> - <input type="checkbox"/> - <input type="checkbox"/> -B-T1- <input type="checkbox"/> - <input type="checkbox"/>
		M	ICSA3 [ICSPA3] -BA3MB1M-A- <input type="checkbox"/> - <input type="checkbox"/> - <input type="checkbox"/> -B-T1- <input type="checkbox"/> - <input type="checkbox"/>
		L	ICSA3 [ICSPA3] -BA3MB1L-A- <input type="checkbox"/> - <input type="checkbox"/> - <input type="checkbox"/> -B-T1- <input type="checkbox"/> - <input type="checkbox"/>
	4	H	ICSA3 [ICSPA3] -BA4MB1H-A- <input type="checkbox"/> - <input type="checkbox"/> - <input type="checkbox"/> -B-T1- <input type="checkbox"/> - <input type="checkbox"/>
		M	ICSA3 [ICSPA3] -BA4MB1M-A- <input type="checkbox"/> - <input type="checkbox"/> - <input type="checkbox"/> -B-T1- <input type="checkbox"/> - <input type="checkbox"/>
		L	ICSA3 [ICSPA3] -BA4MB1L-A- <input type="checkbox"/> - <input type="checkbox"/> - <input type="checkbox"/> -B-T1- <input type="checkbox"/> - <input type="checkbox"/>
Incremental	1	H	ICSA3 [ICSPA3] -BA1MB1H-I- <input type="checkbox"/> - <input type="checkbox"/> - <input type="checkbox"/> -B-T1- <input type="checkbox"/> - <input type="checkbox"/>
		M	ICSA3 [ICSPA3] -BA1MB1M-I- <input type="checkbox"/> - <input type="checkbox"/> - <input type="checkbox"/> -B-T1- <input type="checkbox"/> - <input type="checkbox"/>
		L	ICSA3 [ICSPA3] -BA1MB1L-I- <input type="checkbox"/> - <input type="checkbox"/> - <input type="checkbox"/> -B-T1- <input type="checkbox"/> - <input type="checkbox"/>
	2	H	ICSA3 [ICSPA3] -BA2MB1H-I- <input type="checkbox"/> - <input type="checkbox"/> - <input type="checkbox"/> -B-T1- <input type="checkbox"/> - <input type="checkbox"/>
		M	ICSA3 [ICSPA3] -BA2MB1M-I- <input type="checkbox"/> - <input type="checkbox"/> - <input type="checkbox"/> -B-T1- <input type="checkbox"/> - <input type="checkbox"/>
		L	ICSA3 [ICSPA3] -BA2MB1L-I- <input type="checkbox"/> - <input type="checkbox"/> - <input type="checkbox"/> -B-T1- <input type="checkbox"/> - <input type="checkbox"/>
	3	H	ICSA3 [ICSPA3] -BA3MB1H-I- <input type="checkbox"/> - <input type="checkbox"/> - <input type="checkbox"/> -B-T1- <input type="checkbox"/> - <input type="checkbox"/>
		M	ICSA3 [ICSPA3] -BA3MB1M-I- <input type="checkbox"/> - <input type="checkbox"/> - <input type="checkbox"/> -B-T1- <input type="checkbox"/> - <input type="checkbox"/>
		L	ICSA3 [ICSPA3] -BA3MB1L-I- <input type="checkbox"/> - <input type="checkbox"/> - <input type="checkbox"/> -B-T1- <input type="checkbox"/> - <input type="checkbox"/>
	4	H	ICSA3 [ICSPA3] -BA4MB1H-I- <input type="checkbox"/> - <input type="checkbox"/> - <input type="checkbox"/> -B-T1- <input type="checkbox"/> - <input type="checkbox"/>
		M	ICSA3 [ICSPA3] -BA4MB1M-I- <input type="checkbox"/> - <input type="checkbox"/> - <input type="checkbox"/> -B-T1- <input type="checkbox"/> - <input type="checkbox"/>
		L	ICSA3 [ICSPA3] -BA4MB1L-I- <input type="checkbox"/> - <input type="checkbox"/> - <input type="checkbox"/> -B-T1- <input type="checkbox"/> - <input type="checkbox"/>

*1: Refer to the figure below for XY-axis configuration direction.
*2: The load capacity and the maximum speed may vary depending on the type of Z-axis.
Note: T1 in the above models will be T2 when operated with XSEL-P/Q type.

Explanation of Model Code

Number	Contents	Specification
<input type="checkbox"/>	X-axis stroke (Note 1)	10 : 100mm ~ 60 : 600mm
<input type="checkbox"/>	Y-axis stroke (Note 1)	10 : 100mm ~ 40 : 400mm
<input type="checkbox"/>	Z-axis stroke (Note 1)	10 : 100mm ~ 30 : 300mm
<input type="checkbox"/>	Cable length (Note 2)	3L : 3m 5L : 5m
<input type="checkbox"/>	Y-axis/ Z-axis cable management	SC-SC : Self-standing cable CT-CT : Cable track

* The above explains the Models/Specifications chart to the left.

Options

Please add the option codes at the end of each stroke of the axis.
When adding multiple options, put together in alphabetic order.

Name	Code	Page
AQ seal	AQ	P13
Brake	B	P13
Creep sensor	C	P13
Home limit switch	L	P14
Reversed-home specification	NM	P14
Guide with ball-retaining mechanism	RT	P14

Configuration Direction

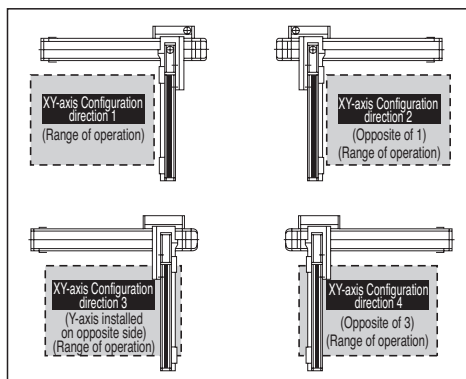

Common Specifications * [] is for the high-precision specification.

Drive system	Ball screw, rolled C10 [equivalent to rolled C5]
Positioning repeatability	±0.02mm [±0.01mm]
Backlash	0.05mm or less [0.02mm or less]
Guide	Integrated with base
Base	Material: Aluminum with white alumite treatment
X-axis motor output / lead	60W / 8mm
Y-axis motor output / lead	60W / 8mm
Z-axis motor output / lead	60W / 16mm (H), 8mm (M), 4mm (L)

Applicable Controller Specifications

Refer to page 65 for System Configuration.

Axis Configuration * [] is for the high-precision specification.

Axis Type	Model	Page
X-axis	ISA[ISPA]-SXM- <input type="checkbox"/> -60-8-(Stroke)-T1	P15
Y-axis	ISA[ISPA]-SYM- <input type="checkbox"/> -60-8-(Stroke)-T1	P16
Z-axis	ISA[ISPA]-SXM- <input type="checkbox"/> -60-16/8/4-(Stroke)-T1-B	P15

* In the above model name, indicates encoder type A (absolute) or I (incremental).

Caution

(Note 1) The stroke in the model is specified in cm (centimeters).
 (Note 2) The cable length measures from the X-axis connector box to the controller. The standard lengths are 3m and 5m, but other lengths can also be specified in meters. The maximum length is 20m.
 (Note 3) The rated acceleration is 0.3G. Increasing the acceleration will result in lower load capacity.
 (Note 4) Please note that a longer stroke will result in a lower maximum speed.

* For other points to note, please refer to page 49.

ICSA3 [ICSPA3] -BA□MB1□

Load Capacity (kg) (Note3)

BA□MB1H

		Y-axis stroke			
		100	200	300	400
Z-axis stroke	100	3.0		2.9	
	200	3.0		2.3	
	300	3.0		1.7	

BA□MB1M

		Y-axis stroke			
		100	200	300	400
Z-axis stroke	100	6.0		2.9	
	200	6.0		2.3	
	300	6.0	5.7	1.7	

BA□MB1L

		Y-axis stroke			
		100	200	300	400
Z-axis stroke	100	13.0	11.4	6.9	2.9
	200	12.4	10.8	6.3	2.3
	300	11.8	10.2	5.7	1.7

Maximum Speed by Stroke (mm/sec) (Note4)

BA□MB1H

	Stroke					
	100	200	300	400	500	600
X-axis	400					
Y-axis	400					
Z-axis	800	-	-	-	-	-

BA□MB1M

	Stroke					
	100	200	300	400	500	600
X-axis	400					
Y-axis	400					
Z-axis	400	-	-	-	-	-

BA□MB1L

	Stroke					
	100	200	300	400	500	600
X-axis	400					
Y-axis	400					
Z-axis	200	-	-	-	-	-

Dimensions * The dimension below is for XY-axis Configuration direction 1.

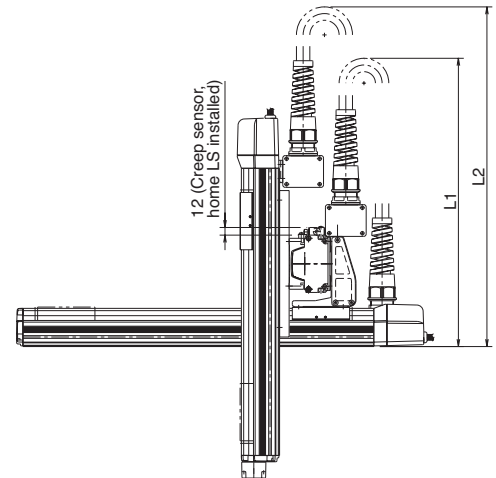
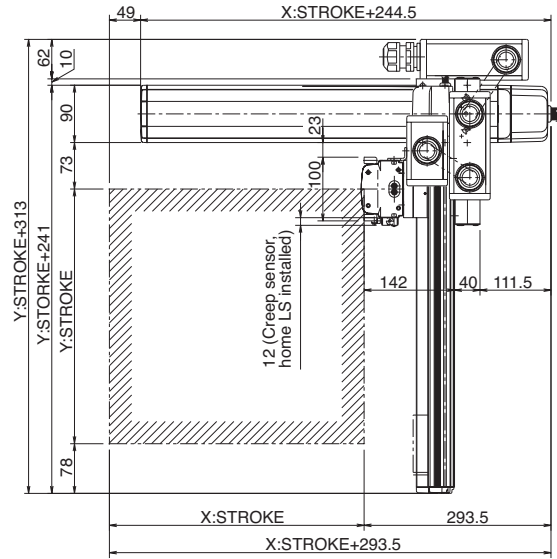
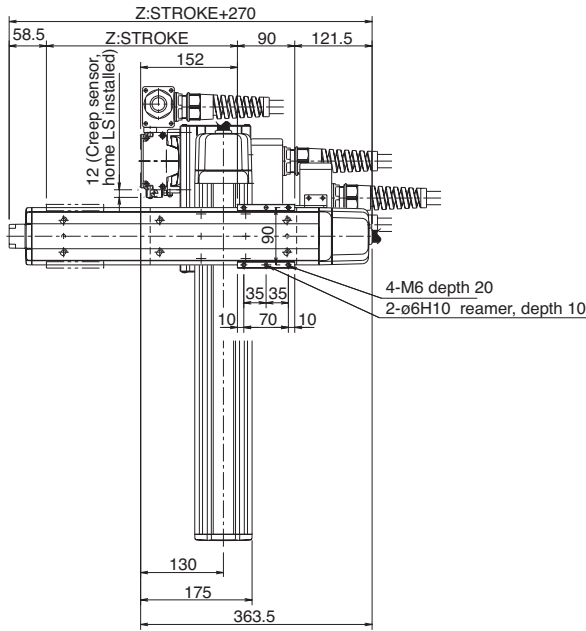

* The configuration position in the figure is home position. To change the home position, indicate NM in the option. Note that changing the home direction will require the actuator to be returned to IAI for adjustment.

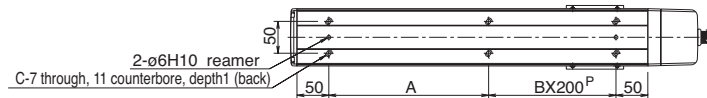

X stroke	100	200	300	400	500	600
L1	(500)	(550)	(600)	(650)	(700)	(750)
A	151	251	151	251	151	251
B	0	0	1	1	2	2
C	4	4	6	6	8	8

Y stroke	100	200	300	400
L2	(590)	(640)	(690)	(740)

ICSA3-BB **HB1**

Cartesian Robot: X-Y-Z 3-Axes Configuration
Z-axis Base Mount Type

ICSPA3-BB **HB1**

Cartesian Robot: X-Y-Z 3-Axes Configuration
Z-axis Base Mount Type **High-Precision Specification**

Type XYB + Z-axis Base Mount Type Stroke X-axis: 200-800mm Y-axis: 100-400mm Z-axis: 100-300mm Load capacity 7.1kg ~ 3kg

Model specification items Series Type Encoder type X-axis stroke + options Y-axis stroke + options Z-axis stroke + options Applicable controller Cable length Cable management
(Example) ICSA3 (ICSPA3) - BB1HB1M - A - 70AQL - 40AQL - 30BL - T1 - 5L - SC - SC

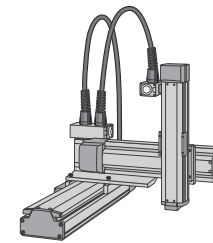

* Refer to page 51 for the details of model specification items.

Models/Specifications

* [] is for the high-precision specification.

Encoder Type	XY-axis configuration direction (*1)	Z-axis type (**2)	Model
Absolute	1	H	ICSA3 [ICSPA3] - BB1HB1H-A- [] - [] - [] - B-T1 - [] - []
		M	ICSA3 [ICSPA3] - BB1HB1M-A- [] - [] - [] - B-T1 - [] - []
		L	ICSA3 [ICSPA3] - BB1HB1L-A- [] - [] - [] - B-T1 - [] - []
	2	H	ICSA3 [ICSPA3] - BB2HB1H-A- [] - [] - [] - B-T1 - [] - []
		M	ICSA3 [ICSPA3] - BB2HB1M-A- [] - [] - [] - B-T1 - [] - []
		L	ICSA3 [ICSPA3] - BB2HB1L-A- [] - [] - [] - B-T1 - [] - []
	3	H	ICSA3 [ICSPA3] - BB3HB1H-A- [] - [] - [] - B-T1 - [] - []
		M	ICSA3 [ICSPA3] - BB3HB1M-A- [] - [] - [] - B-T1 - [] - []
		L	ICSA3 [ICSPA3] - BB3HB1L-A- [] - [] - [] - B-T1 - [] - []
	4	H	ICSA3 [ICSPA3] - BB4HB1H-A- [] - [] - [] - B-T1 - [] - []
		M	ICSA3 [ICSPA3] - BB4HB1M-A- [] - [] - [] - B-T1 - [] - []
		L	ICSA3 [ICSPA3] - BB4HB1L-A- [] - [] - [] - B-T1 - [] - []
Incremental	1	H	ICSA3 [ICSPA3] - BB1HB1H-I- [] - [] - [] - B-T1 - [] - []
		M	ICSA3 [ICSPA3] - BB1HB1M-I- [] - [] - [] - B-T1 - [] - []
		L	ICSA3 [ICSPA3] - BB1HB1L-I- [] - [] - [] - B-T1 - [] - []
	2	H	ICSA3 [ICSPA3] - BB2HB1H-I- [] - [] - [] - B-T1 - [] - []
		M	ICSA3 [ICSPA3] - BB2HB1M-I- [] - [] - [] - B-T1 - [] - []
		L	ICSA3 [ICSPA3] - BB2HB1L-I- [] - [] - [] - B-T1 - [] - []
	3	H	ICSA3 [ICSPA3] - BB3HB1H-I- [] - [] - [] - B-T1 - [] - []
		M	ICSA3 [ICSPA3] - BB3HB1M-I- [] - [] - [] - B-T1 - [] - []
		L	ICSA3 [ICSPA3] - BB3HB1L-I- [] - [] - [] - B-T1 - [] - []
	4	H	ICSA3 [ICSPA3] - BB4HB1H-I- [] - [] - [] - B-T1 - [] - []
		M	ICSA3 [ICSPA3] - BB4HB1M-I- [] - [] - [] - B-T1 - [] - []
		L	ICSA3 [ICSPA3] - BB4HB1L-I- [] - [] - [] - B-T1 - [] - []

*1: Refer to the figure below for XY-axis configuration direction.

*2: The load capacity and the maximum speed may vary depending on the type of Z-axis.

Note: T1 in the above models will be T2 when operated with XSEL-P/Q type.

Explanation of Model Code

Number	Contents	Specification
①	X-axis stroke (Note 1)	20 : 200mm ~ 80 : 800mm
②	Y-axis stroke (Note 1)	10 : 100mm ~ 40 : 400mm
③	Z-axis stroke (Note 1)	10 : 100mm ~ 30 : 300mm
④	Cable length (Note 2)	3L : 3m 5L : 5m
⑤	Y-axis/ Z-axis cable management	SC-SC : Self-standing cable CT-CT : Cable track

* The above explains the Models/Specifications chart to the left.

Options

Please add the option codes at the end of each stroke of the axis. When adding multiple options, put together in alphabetic order.

Name	Code	Page
AQ seal	AQ	P13
Brake	B	P13
Creep sensor	C	P13
Home limit switch	L	P14
Reversed-home specification	NM	P14
Guide with ball-retaining mechanism	RT	P14

Configuration Direction

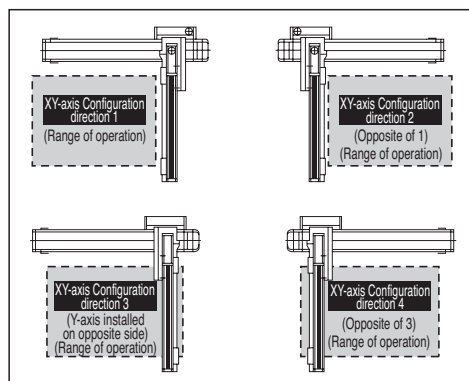

Common Specifications

* [] is for the high-precision specification.

Drive system	Ball screw, rolled C10 [equivalent to rolled C5]
Positioning repeatability	±0.02mm [±0.01mm]
Backlash	0.05mm or less [0.02mm or less]
Guide	Integrated with base
Base	Material: Aluminum with white alumite treatment
X-axis motor output / lead	100W / 20mm
Y-axis motor output / lead	60W / 16mm
Z-axis motor output / lead	60W / 16mm (H), 8mm (M), 4mm (L)

Applicable Controller Specifications

Refer to page 65 for System Configuration.

Axis Configuration

* [] is for the high-precision specification.

Axis Type	Model	Page
X-axis	ISA[ISPA]-MXM-□-100-20-(Stroke)-T1	P18
Y-axis	ISA[ISPA]-SYM-□-60-16-(Stroke)-T1	P16
Z-axis	ISA[ISPA]-SXM-□-60-16/8/4-(Stroke)-T1-B	P15

*In the above model name, □ indicates encoder type A (absolute) or I (incremental).



Caution

(Note 1) The stroke in the model is specified in cm (centimeters).
(Note 2) The cable length measures from the X-axis connector box to the controller. The standard lengths are 3m and 5m, but other lengths can also be specified in meters. The maximum length is 20m.
(Note 3) The rated acceleration is 0.3G. Increasing the acceleration will result in lower load capacity.
(Note 4) Please note that a longer stroke will result in a lower maximum speed.

* For other points to note, please refer to page 49.

ICSA3 [ICSPA3] -BB□HB1□

Load Capacity (kg) (Note3)

BB□HB1H

		Y-axis stroke			
		100	200	300	400
Z-axis stroke	100	3.0			
	200	3.0			
	300	3.0			

BB□HB1M

		Y-axis stroke			
		100	200	300	400
Z-axis stroke	100	6.0			5.9
	200	6.0			5.3
	300	5.6		5.4	4.7

BB□HB1L

		Y-axis stroke			
		100	200	300	400
Z-axis stroke	100	7.1		6.9	6.2
	200	6.1		5.9	5.2
	300	5.6		5.4	4.7

Maximum Speed by Stroke (mm/sec) (Note4)

BB□HB1H

	Stroke								
	100	200	300	400	500	600	700	800	
X-axis	-	1000							795
Y-axis	800		-	-	-	-	-	-	
Z-axis	800	-	-	-	-	-	-	-	

BB□HB1M

	Stroke								
	100	200	300	400	500	600	700	800	
X-axis	-	1000							795
Y-axis	800		-	-	-	-	-	-	
Z-axis	400	-	-	-	-	-	-	-	

BB□HB1L

	Stroke								
	100	200	300	400	500	600	700	800	
X-axis	-	1000							795
Y-axis	800		-	-	-	-	-	-	
Z-axis	200	-	-	-	-	-	-	-	

Dimensions * The dimension below is for XY-axis Configuration direction 1.

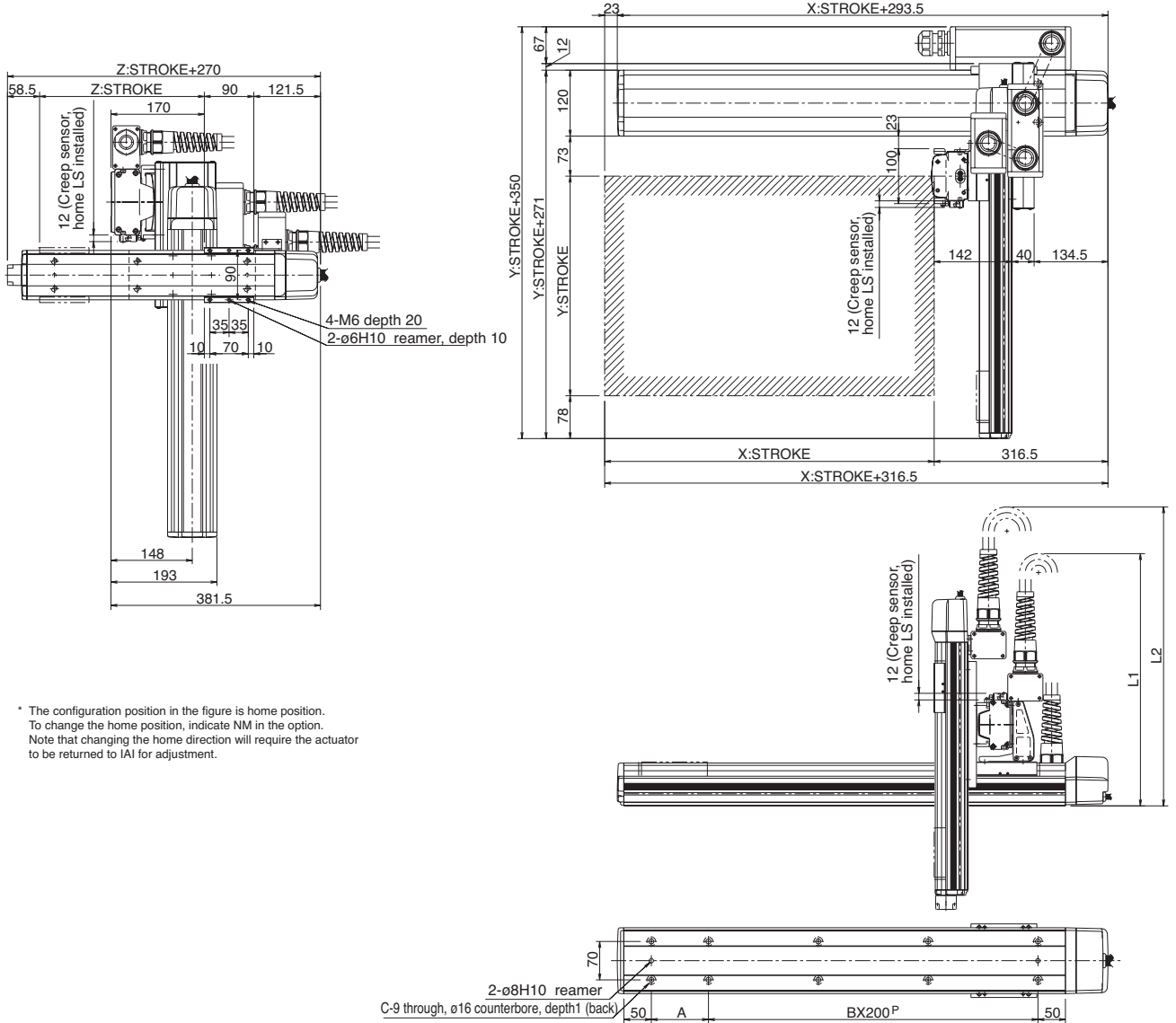

* The configuration position in the figure is home position. To change the home position, indicate NM in the option. Note that changing the home direction will require the actuator to be returned to IAI for adjustment.

X stroke	200	300	400	500	600	700	800
L1	(550)	(600)	(650)	(700)	(750)	(800)	(850)
A	104	204	104	204	104	204	104
B	1	1	2	2	3	3	4
C	6	6	8	8	10	10	12

Y stroke	100	200	300	400
L2	(600)	(650)	(700)	(750)

ICSA3-BB **MB1**

Cartesian Robot: X-Y-Z 3-Axes Configuration
Z-axis Base Mount Type

ICSPA3-BB **MB1**

Cartesian Robot: X-Y-Z 3-Axes Configuration
Z-axis Base Mount Type **High-Precision Specification**

Type XYB + Z-axis Base Mount Type Stroke X-axis: 200-800mm Y-axis: 100-400mm Z-axis: 100-300mm Load capacity 14kg ~ 3kg

Model specification items Series Type Encoder type X-axis stroke + options Y-axis stroke + options Z-axis stroke + options Applicable controller Cable length Cable management
(Example) ICSA3 [ICSPA3] - BB1MB1M - A - 70AQL - 40AQL - 30BL - T1 - 5L - SC - SC

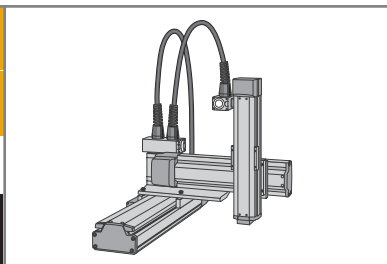

* Refer to page 51 for the details of model specification items.

Models/Specifications * [] is for the high-precision specification.

Encoder Type	XY-axis configuration direction (*1)	Z-axis type (*2)	Model
Absolute	1	H	ICSA3 [ICSPA3] -BB1MB1H-A- <input type="checkbox"/> - <input type="checkbox"/> - <input type="checkbox"/> -B-T1- <input type="checkbox"/> - <input type="checkbox"/>
		M	ICSA3 [ICSPA3] -BB1MB1M-A- <input type="checkbox"/> - <input type="checkbox"/> - <input type="checkbox"/> -B-T1- <input type="checkbox"/> - <input type="checkbox"/>
		L	ICSA3 [ICSPA3] -BB1MB1L-A- <input type="checkbox"/> - <input type="checkbox"/> - <input type="checkbox"/> -B-T1- <input type="checkbox"/> - <input type="checkbox"/>
	2	H	ICSA3 [ICSPA3] -BB2MB1H-A- <input type="checkbox"/> - <input type="checkbox"/> - <input type="checkbox"/> -B-T1- <input type="checkbox"/> - <input type="checkbox"/>
		M	ICSA3 [ICSPA3] -BB2MB1M-A- <input type="checkbox"/> - <input type="checkbox"/> - <input type="checkbox"/> -B-T1- <input type="checkbox"/> - <input type="checkbox"/>
		L	ICSA3 [ICSPA3] -BB2MB1L-A- <input type="checkbox"/> - <input type="checkbox"/> - <input type="checkbox"/> -B-T1- <input type="checkbox"/> - <input type="checkbox"/>
	3	H	ICSA3 [ICSPA3] -BB3MB1H-A- <input type="checkbox"/> - <input type="checkbox"/> - <input type="checkbox"/> -B-T1- <input type="checkbox"/> - <input type="checkbox"/>
		M	ICSA3 [ICSPA3] -BB3MB1M-A- <input type="checkbox"/> - <input type="checkbox"/> - <input type="checkbox"/> -B-T1- <input type="checkbox"/> - <input type="checkbox"/>
		L	ICSA3 [ICSPA3] -BB3MB1L-A- <input type="checkbox"/> - <input type="checkbox"/> - <input type="checkbox"/> -B-T1- <input type="checkbox"/> - <input type="checkbox"/>
	4	H	ICSA3 [ICSPA3] -BB4MB1H-A- <input type="checkbox"/> - <input type="checkbox"/> - <input type="checkbox"/> -B-T1- <input type="checkbox"/> - <input type="checkbox"/>
		M	ICSA3 [ICSPA3] -BB4MB1M-A- <input type="checkbox"/> - <input type="checkbox"/> - <input type="checkbox"/> -B-T1- <input type="checkbox"/> - <input type="checkbox"/>
		L	ICSA3 [ICSPA3] -BB4MB1L-A- <input type="checkbox"/> - <input type="checkbox"/> - <input type="checkbox"/> -B-T1- <input type="checkbox"/> - <input type="checkbox"/>
Incremental	1	H	ICSA3 [ICSPA3] -BB1MB1H-I- <input type="checkbox"/> - <input type="checkbox"/> - <input type="checkbox"/> -B-T1- <input type="checkbox"/> - <input type="checkbox"/>
		M	ICSA3 [ICSPA3] -BB1MB1M-I- <input type="checkbox"/> - <input type="checkbox"/> - <input type="checkbox"/> -B-T1- <input type="checkbox"/> - <input type="checkbox"/>
		L	ICSA3 [ICSPA3] -BB1MB1L-I- <input type="checkbox"/> - <input type="checkbox"/> - <input type="checkbox"/> -B-T1- <input type="checkbox"/> - <input type="checkbox"/>
	2	H	ICSA3 [ICSPA3] -BB2MB1H-I- <input type="checkbox"/> - <input type="checkbox"/> - <input type="checkbox"/> -B-T1- <input type="checkbox"/> - <input type="checkbox"/>
		M	ICSA3 [ICSPA3] -BB2MB1M-I- <input type="checkbox"/> - <input type="checkbox"/> - <input type="checkbox"/> -B-T1- <input type="checkbox"/> - <input type="checkbox"/>
		L	ICSA3 [ICSPA3] -BB2MB1L-I- <input type="checkbox"/> - <input type="checkbox"/> - <input type="checkbox"/> -B-T1- <input type="checkbox"/> - <input type="checkbox"/>
	3	H	ICSA3 [ICSPA3] -BB3MB1H-I- <input type="checkbox"/> - <input type="checkbox"/> - <input type="checkbox"/> -B-T1- <input type="checkbox"/> - <input type="checkbox"/>
		M	ICSA3 [ICSPA3] -BB3MB1M-I- <input type="checkbox"/> - <input type="checkbox"/> - <input type="checkbox"/> -B-T1- <input type="checkbox"/> - <input type="checkbox"/>
		L	ICSA3 [ICSPA3] -BB3MB1L-I- <input type="checkbox"/> - <input type="checkbox"/> - <input type="checkbox"/> -B-T1- <input type="checkbox"/> - <input type="checkbox"/>
	4	H	ICSA3 [ICSPA3] -BB4MB1H-I- <input type="checkbox"/> - <input type="checkbox"/> - <input type="checkbox"/> -B-T1- <input type="checkbox"/> - <input type="checkbox"/>
		M	ICSA3 [ICSPA3] -BB4MB1M-I- <input type="checkbox"/> - <input type="checkbox"/> - <input type="checkbox"/> -B-T1- <input type="checkbox"/> - <input type="checkbox"/>
		L	ICSA3 [ICSPA3] -BB4MB1L-I- <input type="checkbox"/> - <input type="checkbox"/> - <input type="checkbox"/> -B-T1- <input type="checkbox"/> - <input type="checkbox"/>

*1: Refer to the figure below for XY-axis configuration direction.
*2: The load capacity and the maximum speed may vary depending on the type of Z-axis.
Note: T1 in the above models will be T2 when operated with XSEL-P/Q type.

Explanation of Model Code

Number	Contents	Specification
<input type="checkbox"/>	X-axis stroke (Note 1)	20 : 200mm ~ 80 : 800mm
<input type="checkbox"/>	Y-axis stroke (Note 1)	10 : 100mm ~ 40 : 400mm
<input type="checkbox"/>	Z-axis stroke (Note 1)	10 : 100mm ~ 30 : 300mm
<input type="checkbox"/>	Cable length (Note 2)	3L : 3m 5L : 5m
<input type="checkbox"/>	Y-axis/ Z-axis cable management	SC-SC : Self-standing cable CT-CT : Cable track

* The above explains the Models/Specifications chart to the left.

Options

Please add the option codes at the end of each stroke of the axis.
When adding multiple options, put together in alphabetic order.

Name	Code	Page
AQ seal	AQ	P13
Brake	B	P13
Creep sensor	C	P13
Home limit switch	L	P14
Reversed-home specification	NM	P14
Guide with ball-retaining mechanism	RT	P14

Configuration Direction

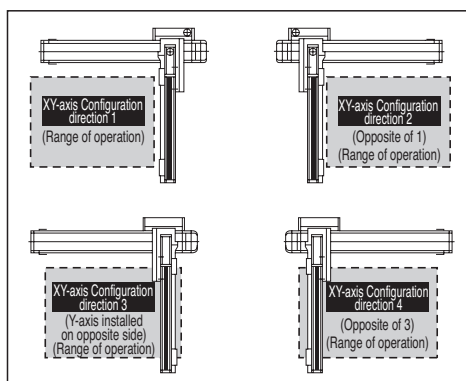

Common Specifications * [] is for the high-precision specification.

Drive system	Ball screw, rolled C10 [equivalent to rolled C5]
Positioning repeatability	±0.02mm [±0.01mm]
Backlash	0.05mm or less [0.02mm or less]
Guide	Integrated with base
Base	Material: Aluminum with white alumite treatment
X-axis motor output / lead	100W / 10mm
Y-axis motor output / lead	60W / 8mm
Z-axis motor output / lead	60W / 16mm (H), 8mm (M), 4mm (L)

Applicable Controller Specifications

Refer to page 65 for System Configuration.

Axis Configuration * [] is for the high-precision specification.

Axis Type	Model	Page
X-axis	ISA[ISPA]-MXM- <input type="checkbox"/> -100-10-(Stroke)-T1	P18
Y-axis	ISA[ISPA]-SYM- <input type="checkbox"/> -60-8-(Stroke)-T1	P16
Z-axis	ISA[ISPA]-SXM- <input type="checkbox"/> -60-16/8/4-(Stroke)-T1-B	P15

* In the above model name, indicates encoder type A (absolute) or I (incremental).



Caution

(Note 1) The stroke in the model is specified in cm (centimeters).
(Note 2) The cable length measures from the X-axis connector box to the controller. The standard lengths are 3m and 5m, but other lengths can also be specified in meters. The maximum length is 20m.
(Note 3) The rated acceleration is 0.3G. Increasing the acceleration will result in lower load capacity.
(Note 4) Please note that a longer stroke will result in a lower maximum speed.

* For other points to note, please refer to page 49.

ICSA3 [ICSPA3] -BB□MB1□

Load Capacity (kg) (Note3)

BB□MB1H

		Y-axis stroke			
		100	200	300	400
Z-axis stroke	100	3.0			
	200	3.0			
	300	3.0			

BB□MB1M

		Y-axis stroke			
		100	200	300	400
Z-axis stroke	100	6.0			
	200	6.0			
	300	6.0			

BB□MB1L

		Y-axis stroke			
		100	200	300	400
Z-axis stroke	100	14.0			
	200	14.0			
	300	14.0			

Maximum Speed by Stroke (mm/sec) (Note4)

BB□MB1H

		Stroke							
		100	200	300	400	500	600	700	800
X-axis	-	500						480	380
Y-axis		400		-	-	-	-	-	
Z-axis		800	-	-	-	-	-	-	

BB□MB1M

		Stroke							
		100	200	300	400	500	600	700	800
X-axis	-	500						480	380
Y-axis		400		-	-	-	-	-	
Z-axis		400	-	-	-	-	-	-	

BB□MB1L

		Stroke							
		100	200	300	400	500	600	700	800
X-axis	-	500						480	380
Y-axis		400		-	-	-	-	-	
Z-axis		200	-	-	-	-	-	-	

Dimensions

* The dimension below is for XY-axis Configuration direction 1.

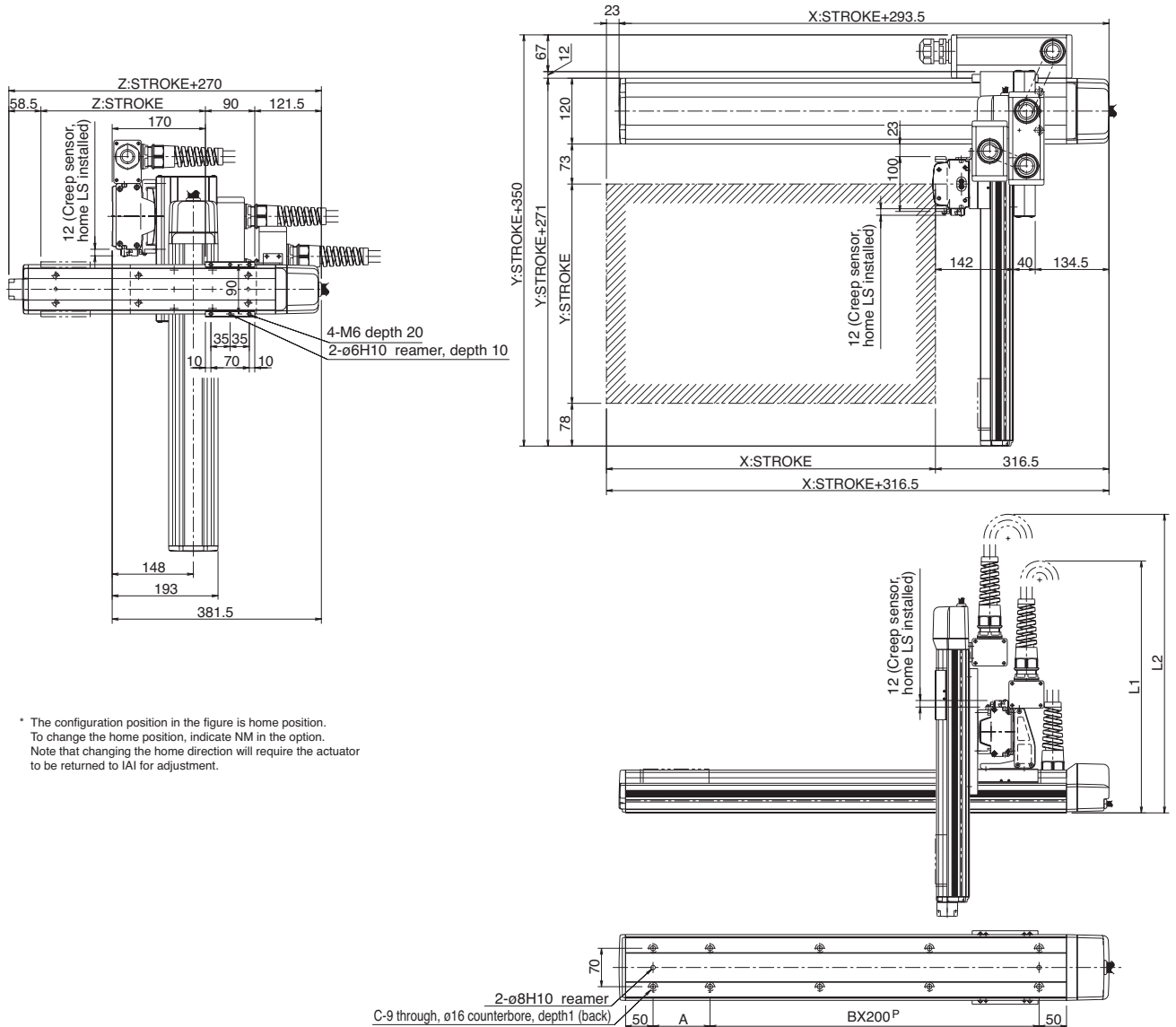

* The configuration position in the figure is home position. To change the home position, indicate NM in the option. Note that changing the home direction will require the actuator to be returned to IAI for adjustment.

X stroke	200	300	400	500	600	700	800
L1	(550)	(600)	(650)	(700)	(750)	(800)	(850)
A	104	204	104	204	104	204	104
B	1	1	2	2	3	3	4
C	6	6	8	8	10	10	12

Y stroke	100	200	300	400
L2	(600)	(650)	(700)	(750)

ICSA3-BB **MB2**

Cartesian Robot: X-Y-Z 3-Axes Configuration
Z-axis Base Mount Type

ICSPA3-BB **MB2**

Cartesian Robot: X-Y-Z 3-Axes Configuration
Z-axis Base Mount Type **High-Precision Specification**

Type XYB + Z-axis Base Mount Type **Stroke** X-axis: 200-800mm Y-axis: 100-400mm Z-axis: 100-400mm **Load capacity** 15.9kg ~ 3.5kg

Model specification items Series - Type - Encoder type - X-axis stroke + options - Y-axis stroke + options - Z-axis stroke + options - Applicable controller - Cable length - Cable management
(Example) ICSA3 (ICSPA3) - BB1MB2M - A - 70AQL - 40AQL - 30BL - T1 - 5L - SC - SC

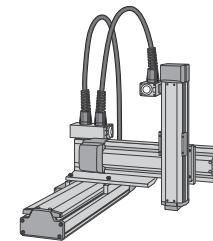

* Refer to page 51 for the details of model specification items.

Models/Specifications

* [] is for the high-precision specification.

Encoder Type	XY-axis configuration direction (*1)	Z-axis type (**2)	Model
Absolute	1	H	ICSA3 [ICSPA3] -BB1MB2H-A- [0]- [2]- [3]-B-T1- [4]- [5]
		M	ICSA3 [ICSPA3] -BB1MB2M-A- [0]- [2]- [3]-B-T1- [4]- [5]
		L	ICSA3 [ICSPA3] -BB1MB2L-A- [0]- [2]- [3]-B-T1- [4]- [5]
	2	H	ICSA3 [ICSPA3] -BB2MB2H-A- [0]- [2]- [3]-B-T1- [4]- [5]
		M	ICSA3 [ICSPA3] -BB2MB2M-A- [0]- [2]- [3]-B-T1- [4]- [5]
		L	ICSA3 [ICSPA3] -BB2MB2L-A- [0]- [2]- [3]-B-T1- [4]- [5]
	3	H	ICSA3 [ICSPA3] -BB3MB2H-A- [0]- [2]- [3]-B-T1- [4]- [5]
		M	ICSA3 [ICSPA3] -BB3MB2M-A- [0]- [2]- [3]-B-T1- [4]- [5]
		L	ICSA3 [ICSPA3] -BB3MB2L-A- [0]- [2]- [3]-B-T1- [4]- [5]
	4	H	ICSA3 [ICSPA3] -BB4MB2H-A- [0]- [2]- [3]-B-T1- [4]- [5]
		M	ICSA3 [ICSPA3] -BB4MB2M-A- [0]- [2]- [3]-B-T1- [4]- [5]
		L	ICSA3 [ICSPA3] -BB4MB2L-A- [0]- [2]- [3]-B-T1- [4]- [5]
Incremental	1	H	ICSA3 [ICSPA3] -BB1MB2H-I- [0]- [2]- [3]-B-T1- [4]- [5]
		M	ICSA3 [ICSPA3] -BB1MB2M-I- [0]- [2]- [3]-B-T1- [4]- [5]
		L	ICSA3 [ICSPA3] -BB1MB2L-I- [0]- [2]- [3]-B-T1- [4]- [5]
	2	H	ICSA3 [ICSPA3] -BB2MB2H-I- [0]- [2]- [3]-B-T1- [4]- [5]
		M	ICSA3 [ICSPA3] -BB2MB2M-I- [0]- [2]- [3]-B-T1- [4]- [5]
		L	ICSA3 [ICSPA3] -BB2MB2L-I- [0]- [2]- [3]-B-T1- [4]- [5]
	3	H	ICSA3 [ICSPA3] -BB3MB2H-I- [0]- [2]- [3]-B-T1- [4]- [5]
		M	ICSA3 [ICSPA3] -BB3MB2M-I- [0]- [2]- [3]-B-T1- [4]- [5]
		L	ICSA3 [ICSPA3] -BB3MB2L-I- [0]- [2]- [3]-B-T1- [4]- [5]
	4	H	ICSA3 [ICSPA3] -BB4MB2H-I- [0]- [2]- [3]-B-T1- [4]- [5]
		M	ICSA3 [ICSPA3] -BB4MB2M-I- [0]- [2]- [3]-B-T1- [4]- [5]
		L	ICSA3 [ICSPA3] -BB4MB2L-I- [0]- [2]- [3]-B-T1- [4]- [5]

*1: Refer to the figure below for XY-axis configuration direction.

*2: The load capacity and the maximum speed may vary depending on the type of Z-axis.

Note: T1 in the above models will be T2 when operated with XSEL-P/Q type.

Explanation of Model Code

Number	Contents	Specification
①	X-axis stroke (Note 1)	20 : 200mm ~ 80 : 800mm
②	Y-axis stroke (Note 1)	10 : 100mm ~ 40 : 400mm
③	Z-axis stroke (Note 1)	10 : 100mm ~ 40 : 400mm
④	Cable length (Note 2)	3L : 3m 5L : 5m
⑤	Y-axis/ Z-axis cable management	SC-SC : Self-standing cable CT-CT : Cable track

* The above explains the Models/Specifications chart to the left.

Options

Please add the option codes at the end of each stroke of the axis. When adding multiple options, put together in alphabetic order.

Name	Code	Page
AQ seal	AQ	P13
Brake	B	P13
Creep sensor	C	P13
Home limit switch	L	P14
Reversed-home specification	NM	P14
Guide with ball-retaining mechanism	RT	P14

Configuration Direction

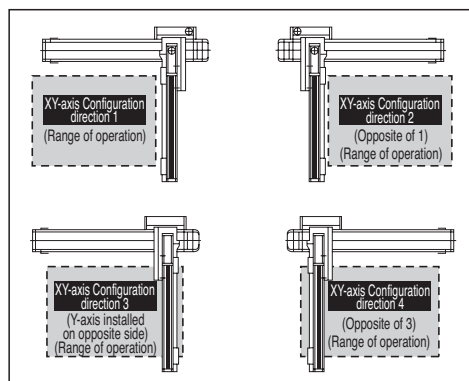

Common Specifications

* [] is for the high-precision specification.

Drive system	Ball screw, rolled C10 [equivalent to rolled C5]
Positioning repeatability	0.02mm [0.01mm]
Backlash	0.05mm or less [0.02mm or less]
Guide	Integrated with base
Base	Material: Aluminum with white alumite treatment
X-axis motor output / lead	100W / 10mm
Y-axis motor output / lead	60W / 8mm
Z-axis motor output / lead	100W / 20mm (H), 10mm (M), 5mm (L)

Applicable Controller Specifications

Refer to page 65 for System Configuration.

Axis Configuration

* [] is for the high-precision specification.

Axis Type	Model	Page
X-axis	ISA[ISPA]-MXM-□-100-10-(Stroke)-T1	P18
Y-axis	ISA[ISPA]-SYM-□-60-8-(Stroke)-T1	P16
Z-axis	ISA[ISPA]-MXM-□-100-20/10/5-(Stroke)-T1-B	P18

*In the above model name, □ indicates encoder type A (absolute) or I (incremental).



Caution

(Note 1) The stroke in the model is specified in cm (centimeters).
(Note 2) The cable length measures from the X-axis connector box to the controller. The standard lengths are 3m and 5m, but other lengths can also be specified in meters. The maximum length is 20m.
(Note 3) The rated acceleration is 0.3G. Increasing the acceleration will result in lower load capacity.
(Note 4) Please note that a longer stroke will result in a lower maximum speed.

* For other points to note, please refer to page 49.

ICSA3 [ICSPA3] -BB□MB2□

Load Capacity (kg) (Note3)

BB□MB2H

		Y-axis stroke			
		100	200	300	400
Z-axis stroke	100	3.5			
	200	3.5			
	300	3.5			
	400	3.5			

BB□MB2M

		Y-axis stroke			
		100	200	300	400
Z-axis stroke	100	9.0			
	200	9.0			
	300	9.0			
	400	9.0			

BB□MB2L

		Y-axis stroke			
		100	200	300	400
Z-axis stroke	100	15.9			12.7
	200	14.6			11.4
	300	13.8			10.6
	300	12.8			9.6

Maximum Speed by Stroke (mm/sec) (Note4)

BB□MB2H

	Stroke								
	100	200	300	400	500	600	700	800	
X-axis	-	500					480	380	
Y-axis	400			-	-	-	-	-	
Z-axis	1000	-	-	-	-	-	-	-	

BB□MB2M

	Stroke								
	100	200	300	400	500	600	700	800	
X-axis	-	500					480	380	
Y-axis	400			-	-	-	-	-	
Z-axis	500	-	-	-	-	-	-	-	

BB□MB2L

	Stroke								
	100	200	300	400	500	600	700	800	
X-axis	-	500					480	380	
Y-axis	400			-	-	-	-	-	
Z-axis	250	-	-	-	-	-	-	-	

Dimensions

* The dimension below is for XY-axis Configuration direction 1.

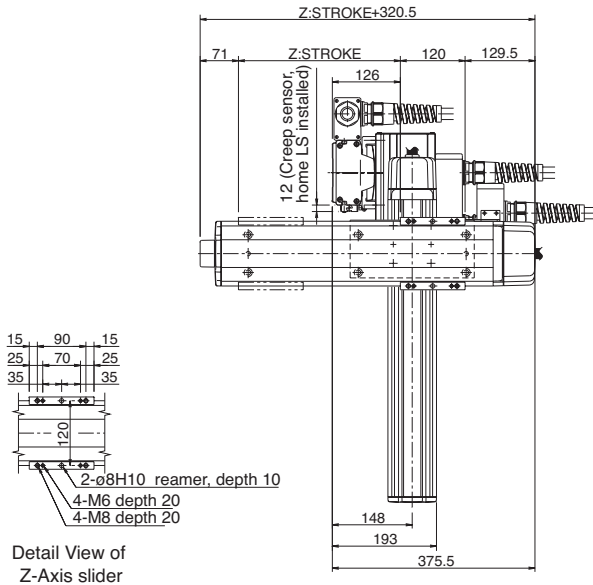

Detail View of Z-Axis slider

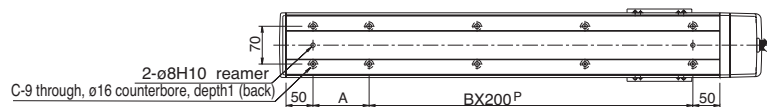
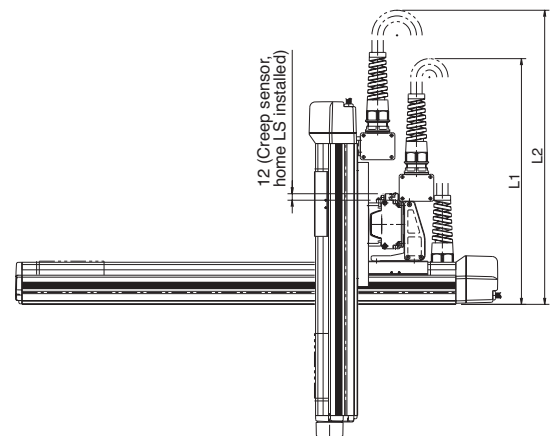
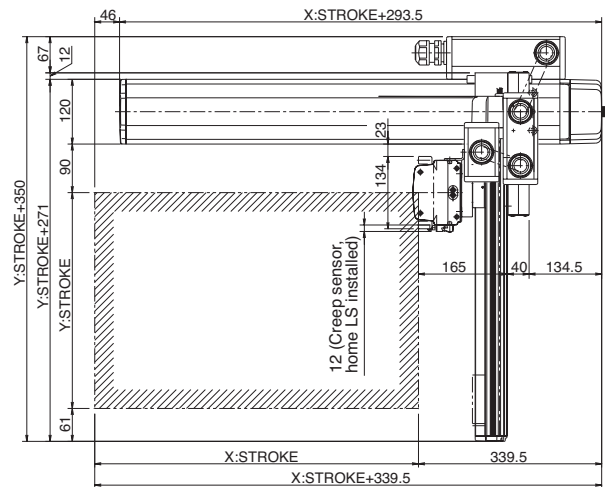

* The configuration position in the figure is home position. To change the home position, indicate NM in the option. Note that changing the home direction will require the actuator to be returned to IAI for adjustment.

X stroke	200	300	400	500	600	700	800
L1	(550)	(600)	(650)	(700)	(750)	(800)	(850)
A	104	204	104	204	104	204	104
B	1	1	2	2	3	3	4
C	6	6	8	8	10	10	12

Y stroke	100	200	300	400
L2	(600)	(650)	(700)	(750)

ICSA3-BC **HB1**

Cartesian Robot: X-Y-Z 3-Axes Configuration
Z-axis Base Mount Type

ICSPA3-BC **HB1**

Cartesian Robot: X-Y-Z 3-Axes Configuration
Z-axis Base Mount Type **High-Precision Specification**

Type XYB + Z-axis Base Mount Type Stroke X-axis: 200-800mm Y-axis: 100-500mm Z-axis: 100-400mm Load capacity 14kg ~ 3kg

Model specification items Series - Type - Encoder type - X-axis stroke + options - Y-axis stroke + options - Z-axis stroke + options - Applicable controller - Cable length - Cable management
(Example) ICSA3 (ICSPA3) - BC1HB1M - A - 70AQL - 40AQL - 30BL - T1 - 5L - SC-SC

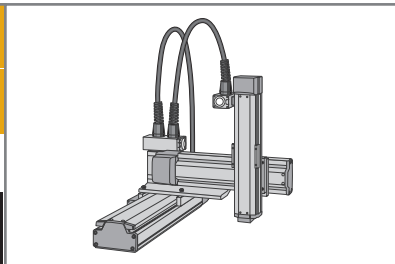

* Refer to page 51 for the details of model specification items.

Models/Specifications

* [] is for the high-precision specification.

Encoder Type	XY-axis configuration direction (*1)	Z-axis type (*2)	Model
Absolute	1	H	ICSA3 [ICSPA3] -BC1HB1H-A- <input type="checkbox"/> - <input type="checkbox"/> - <input type="checkbox"/> -B-T1- <input type="checkbox"/> - <input type="checkbox"/>
		M	ICSA3 [ICSPA3] -BC1HB1M-A- <input type="checkbox"/> - <input type="checkbox"/> - <input type="checkbox"/> -B-T1- <input type="checkbox"/> - <input type="checkbox"/>
		L	ICSA3 [ICSPA3] -BC1HB1L-A- <input type="checkbox"/> - <input type="checkbox"/> - <input type="checkbox"/> -B-T1- <input type="checkbox"/> - <input type="checkbox"/>
	2	H	ICSA3 [ICSPA3] -BC2HB1H-A- <input type="checkbox"/> - <input type="checkbox"/> - <input type="checkbox"/> -B-T1- <input type="checkbox"/> - <input type="checkbox"/>
		M	ICSA3 [ICSPA3] -BC2HB1M-A- <input type="checkbox"/> - <input type="checkbox"/> - <input type="checkbox"/> -B-T1- <input type="checkbox"/> - <input type="checkbox"/>
		L	ICSA3 [ICSPA3] -BC2HB1L-A- <input type="checkbox"/> - <input type="checkbox"/> - <input type="checkbox"/> -B-T1- <input type="checkbox"/> - <input type="checkbox"/>
	3	H	ICSA3 [ICSPA3] -BC3HB1H-A- <input type="checkbox"/> - <input type="checkbox"/> - <input type="checkbox"/> -B-T1- <input type="checkbox"/> - <input type="checkbox"/>
		M	ICSA3 [ICSPA3] -BC3HB1M-A- <input type="checkbox"/> - <input type="checkbox"/> - <input type="checkbox"/> -B-T1- <input type="checkbox"/> - <input type="checkbox"/>
		L	ICSA3 [ICSPA3] -BC3HB1L-A- <input type="checkbox"/> - <input type="checkbox"/> - <input type="checkbox"/> -B-T1- <input type="checkbox"/> - <input type="checkbox"/>
	4	H	ICSA3 [ICSPA3] -BC4HB1H-A- <input type="checkbox"/> - <input type="checkbox"/> - <input type="checkbox"/> -B-T1- <input type="checkbox"/> - <input type="checkbox"/>
		M	ICSA3 [ICSPA3] -BC4HB1M-A- <input type="checkbox"/> - <input type="checkbox"/> - <input type="checkbox"/> -B-T1- <input type="checkbox"/> - <input type="checkbox"/>
		L	ICSA3 [ICSPA3] -BC4HB1L-A- <input type="checkbox"/> - <input type="checkbox"/> - <input type="checkbox"/> -B-T1- <input type="checkbox"/> - <input type="checkbox"/>
Incremental	1	H	ICSA3 [ICSPA3] -BC1HB1H-I- <input type="checkbox"/> - <input type="checkbox"/> - <input type="checkbox"/> -B-T1- <input type="checkbox"/> - <input type="checkbox"/>
		M	ICSA3 [ICSPA3] -BC1HB1M-I- <input type="checkbox"/> - <input type="checkbox"/> - <input type="checkbox"/> -B-T1- <input type="checkbox"/> - <input type="checkbox"/>
		L	ICSA3 [ICSPA3] -BC1HB1L-I- <input type="checkbox"/> - <input type="checkbox"/> - <input type="checkbox"/> -B-T1- <input type="checkbox"/> - <input type="checkbox"/>
	2	H	ICSA3 [ICSPA3] -BC2HB1H-I- <input type="checkbox"/> - <input type="checkbox"/> - <input type="checkbox"/> -B-T1- <input type="checkbox"/> - <input type="checkbox"/>
		M	ICSA3 [ICSPA3] -BC2HB1M-I- <input type="checkbox"/> - <input type="checkbox"/> - <input type="checkbox"/> -B-T1- <input type="checkbox"/> - <input type="checkbox"/>
		L	ICSA3 [ICSPA3] -BC2HB1L-I- <input type="checkbox"/> - <input type="checkbox"/> - <input type="checkbox"/> -B-T1- <input type="checkbox"/> - <input type="checkbox"/>
	3	H	ICSA3 [ICSPA3] -BC3HB1H-I- <input type="checkbox"/> - <input type="checkbox"/> - <input type="checkbox"/> -B-T1- <input type="checkbox"/> - <input type="checkbox"/>
		M	ICSA3 [ICSPA3] -BC3HB1M-I- <input type="checkbox"/> - <input type="checkbox"/> - <input type="checkbox"/> -B-T1- <input type="checkbox"/> - <input type="checkbox"/>
		L	ICSA3 [ICSPA3] -BC3HB1L-I- <input type="checkbox"/> - <input type="checkbox"/> - <input type="checkbox"/> -B-T1- <input type="checkbox"/> - <input type="checkbox"/>
	4	H	ICSA3 [ICSPA3] -BC4HB1H-I- <input type="checkbox"/> - <input type="checkbox"/> - <input type="checkbox"/> -B-T1- <input type="checkbox"/> - <input type="checkbox"/>
		M	ICSA3 [ICSPA3] -BC4HB1M-I- <input type="checkbox"/> - <input type="checkbox"/> - <input type="checkbox"/> -B-T1- <input type="checkbox"/> - <input type="checkbox"/>
		L	ICSA3 [ICSPA3] -BC4HB1L-I- <input type="checkbox"/> - <input type="checkbox"/> - <input type="checkbox"/> -B-T1- <input type="checkbox"/> - <input type="checkbox"/>

*1: Refer to the figure below for XY-axis configuration direction.
*2: The load capacity and the maximum speed may vary depending on the type of Z-axis.
Note: T1 in the above models will be T2 when operated with XSEL-P/Q type.

Explanation of Model Code

Number	Contents	Specification
<input type="checkbox"/>	X-axis stroke (Note 1)	20 : 200mm ~ 80 : 800mm
<input type="checkbox"/>	Y-axis stroke (Note 1)	10 : 100mm ~ 50 : 500mm
<input type="checkbox"/>	Z-axis stroke (Note 1)	10 : 100mm ~ 40 : 400mm
<input type="checkbox"/>	Cable length (Note 2)	3L : 3m 5L : 5m
<input type="checkbox"/>	Y-axis/ Z-axis cable management	SC-SC : Self-standing cable CT-CT : Cable track

* The above explains the Models/Specifications chart to the left.

Options

Please add the option codes at the end of each stroke of the axis. When adding multiple options, put together in alphabetic order.

Name	Code	Page
AQ seal	AQ	P13
Brake	B	P13
Creep sensor	C	P13
Home limit switch	L	P14
Reversed-home specification	NM	P14
Guide with ball-retaining mechanism	RT	P14

Configuration Direction

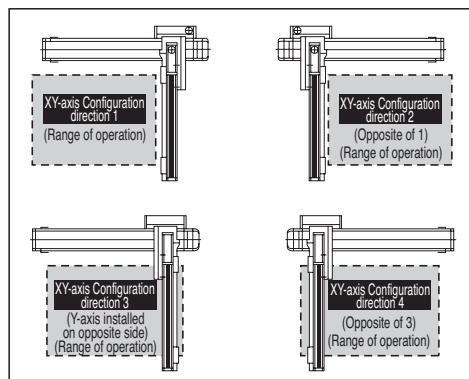

Common Specifications

* [] is for the high-precision specification.

Drive system	Ball screw, rolled C10 [equivalent to rolled C5]
Positioning repeatability	±0.02mm [±0.01mm]
Backlash	0.05mm or less [0.02mm or less]
Guide	Integrated with base
Base	Material: Aluminum with white alumite treatment
X-axis motor output / lead	200W / 20mm
Y-axis motor output / lead	100W / 20mm
Z-axis motor output / lead	60W / 16mm (H), 8mm (M), 4mm (L)

Applicable Controller Specifications

Refer to page 65 for System Configuration.

Axis Configuration

* [] is for the high-precision specification.

Axis Type	Model	Page
X-axis	ISA[ISPA]-MXM- <input type="checkbox"/> -200-20-(Stroke)-T1	P19
Y-axis	ISA[ISPA]-MYM- <input type="checkbox"/> -100-20-(Stroke)-T1	P21
Z-axis	ISA[ISPA]-SXM- <input type="checkbox"/> -60-16/8/4-(Stroke)-T1-B	P15

* In the above model name, indicates encoder type A (absolute) or I (incremental).



Caution

(Note 1) The stroke in the model is specified in cm (centimeters).
(Note 2) The cable length measures from the X-axis connector box to the controller. The standard lengths are 3m and 5m, but other lengths can also be specified in meters. The maximum length is 20m.
(Note 3) The rated acceleration is 0.3G. Increasing the acceleration will result in lower load capacity.
(Note 4) Please note that a longer stroke will result in a lower maximum speed.

* For other points to note, please refer to page 49.

ICSA3 [ICSPA3] -BC□HB1□

Load Capacity (kg) (Note3)

BC□HB1H

		Y-axis stroke				
		100	200	300	400	500
Z-axis stroke	100	3.0				
	200	3.0				
	300	3.0				
	400	3.0				

BC□HB1M

		Y-axis stroke				
		100	200	300	400	500
Z-axis stroke	100	6.0				
	200	6.0				
	300	6.0				
	400	6.0				

BC□HB1L

		Y-axis stroke				
		100	200	300	400	500
Z-axis stroke	100	14.0				13.5
	200	14.0				12.9
	300	14.0				12.3
	300	13.5				11.7

Maximum Speed by Stroke (mm/sec) (Note4)

BC□HB1H

	Stroke								
	100	200	300	400	500	600	700	800	
X-axis	-	1000						795	
Y-axis	1000				-	-	-	-	
Z-axis	800		-	-	-	-	-	-	

BC□HB1M

	Stroke								
	100	200	300	400	500	600	700	800	
X-axis	-	1000						795	
Y-axis	1000				-	-	-	-	
Z-axis	400		-	-	-	-	-	-	

BC□HB1L

	Stroke								
	100	200	300	400	500	600	700	800	
X-axis	-	1000						795	
Y-axis	1000				-	-	-	-	
Z-axis	200		-	-	-	-	-	-	

Dimensions

* The dimension below is for XY-axis Configuration direction 1.

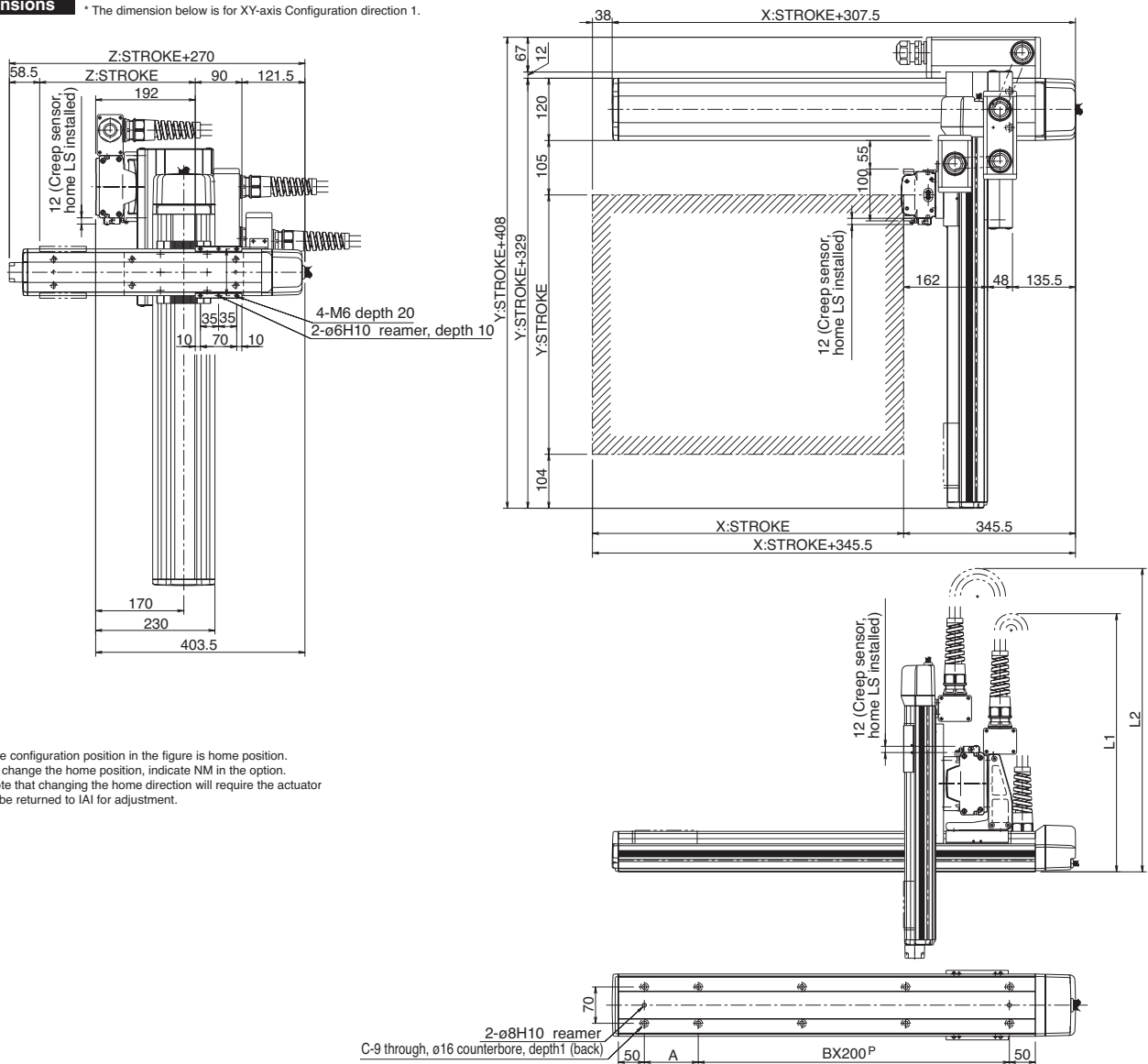

* The configuration position in the figure is home position. To change the home position, indicate NM in the option. Note that changing the home direction will require the actuator to be returned to IAI for adjustment.

X stroke	200	300	400	500	600	700	800
L1	(550)	(600)	(650)	(700)	(750)	(800)	(850)
A	104	204	104	204	104	204	104
B	1	1	2	2	3	3	4
C	6	6	8	8	10	10	12

Y stroke	100	200	300	400	500
L2	(630)	(680)	(730)	(780)	(830)

ICSA3-BC **HB2**

Cartesian Robot: X-Y-Z 3-Axes Configuration
Z-Axis Base Mount Type

ICSPA3-BC **HB2**

Cartesian Robot: X-Y-Z 3-Axes Configuration
Z-Axis Base Mount Type **High-Precision Specification**

Type XYB + Z-Axis Base Mount Type Stroke X-axis: 200-800mm Y-axis: 100-500mm Z-axis: 100-400mm Load capacity 10.7kg ~ 3.5kg

Model specification items Series - Type - Encoder type - X-axis stroke + options - Y-axis stroke + options - Z-axis stroke + options - Applicable controller - Cable length - Cable management
(Example) ICSA3 (ICSPA3) - BC1HB2M - A - 70AQL - 40AQL - 30BL - T1 - 5L - SC - SC

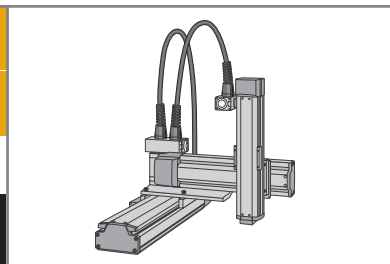

* Refer to page 51 for the details of model specification items.

Models/Specifications * [] is for the high-precision specification.

Encoder Type	XY-axis configuration direction (*1)	Z-axis type (*2)	Model
Absolute	1	H	ICSA3 [ICSPA3] -BC1HB2H-A- [0] - [2] - [3] -B-T1- [4] - [5]
		M	ICSA3 [ICSPA3] -BC1HB2M-A- [0] - [2] - [3] -B-T1- [4] - [5]
		L	ICSA3 [ICSPA3] -BC1HB2L-A- [0] - [2] - [3] -B-T1- [4] - [5]
	2	H	ICSA3 [ICSPA3] -BC2HB2H-A- [0] - [2] - [3] -B-T1- [4] - [5]
		M	ICSA3 [ICSPA3] -BC2HB2M-A- [0] - [2] - [3] -B-T1- [4] - [5]
		L	ICSA3 [ICSPA3] -BC2HB2L-A- [0] - [2] - [3] -B-T1- [4] - [5]
	3	H	ICSA3 [ICSPA3] -BC3HB2H-A- [0] - [2] - [3] -B-T1- [4] - [5]
		M	ICSA3 [ICSPA3] -BC3HB2M-A- [0] - [2] - [3] -B-T1- [4] - [5]
		L	ICSA3 [ICSPA3] -BC3HB2L-A- [0] - [2] - [3] -B-T1- [4] - [5]
	4	H	ICSA3 [ICSPA3] -BC4HB2H-A- [0] - [2] - [3] -B-T1- [4] - [5]
		M	ICSA3 [ICSPA3] -BC4HB2M-A- [0] - [2] - [3] -B-T1- [4] - [5]
		L	ICSA3 [ICSPA3] -BC4HB2L-A- [0] - [2] - [3] -B-T1- [4] - [5]
Incremental	1	H	ICSA3 [ICSPA3] -BC1HB2H-I- [0] - [2] - [3] -B-T1- [4] - [5]
		M	ICSA3 [ICSPA3] -BC1HB2M-I- [0] - [2] - [3] -B-T1- [4] - [5]
		L	ICSA3 [ICSPA3] -BC1HB2L-I- [0] - [2] - [3] -B-T1- [4] - [5]
	2	H	ICSA3 [ICSPA3] -BC2HB2H-I- [0] - [2] - [3] -B-T1- [4] - [5]
		M	ICSA3 [ICSPA3] -BC2HB2M-I- [0] - [2] - [3] -B-T1- [4] - [5]
		L	ICSA3 [ICSPA3] -BC2HB2L-I- [0] - [2] - [3] -B-T1- [4] - [5]
	3	H	ICSA3 [ICSPA3] -BC3HB2H-I- [0] - [2] - [3] -B-T1- [4] - [5]
		M	ICSA3 [ICSPA3] -BC3HB2M-I- [0] - [2] - [3] -B-T1- [4] - [5]
		L	ICSA3 [ICSPA3] -BC3HB2L-I- [0] - [2] - [3] -B-T1- [4] - [5]
	4	H	ICSA3 [ICSPA3] -BC4HB2H-I- [0] - [2] - [3] -B-T1- [4] - [5]
		M	ICSA3 [ICSPA3] -BC4HB2M-I- [0] - [2] - [3] -B-T1- [4] - [5]
		L	ICSA3 [ICSPA3] -BC4HB2L-I- [0] - [2] - [3] -B-T1- [4] - [5]

*1: Refer to the figure below for XY-axis configuration direction.
*2: The load capacity and the maximum speed may vary depending on the type of Z-axis.
Note: T1 in the above models will be T2 when operated with XSEL-P/Q type.

Explanation of Model Code

Number	Contents	Specification
[0]	X-axis stroke (Note 1)	20 : 200mm ~ 80 : 800mm
[2]	Y-axis stroke (Note 1)	10 : 100mm ~ 50 : 500mm
[3]	Z-axis stroke (Note 1)	10 : 100mm ~ 40 : 400mm
[4]	Cable length (Note 2)	3L : 3m 5L : 5m
[5]	Y-axis/ Z-axis cable management	SC-SC : Self-standing cable CT-CT : Cable track

* The above explains the Models/Specifications chart to the left.

Options

Please add the option codes at the end of each stroke of the axis.
When adding multiple options, put together in alphabetic order.

Name	Code	Page
AQ seal	AQ	P13
Brake	B	P13
Creep sensor	C	P13
Home limit switch	L	P14
Reversed-home specification	NM	P14
Guide with ball-retaining mechanism	RT	P14

Configuration Direction

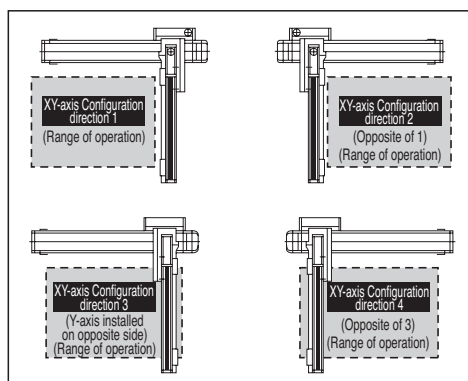

Common Specifications * [] is for the high-precision specification.

Drive system	Ball screw, rolled C10 [equivalent to rolled C5]
Positioning repeatability	±0.02mm [±0.01mm]
Backlash	0.05mm or less [0.02mm or less]
Guide	Integrated with base
Base	Material: Aluminum with white alumite treatment
X-axis motor output / lead	200W / 20mm
Y-axis motor output / lead	100W / 20mm
Z-axis motor output / lead	100W / 20mm (H), 10mm (M), 5mm (L)

Applicable Controller Specifications

Refer to page 65 for System Configuration.

Axis Configuration * [] is for the high-precision specification.

Axis Type	Model	Page
X-axis	ISA[ISPA]-MXM-□-100-20-(Stroke)-T1	P19
Y-axis	ISA[ISPA]-MYM-□-100-20-(Stroke)-T1	P21
Z-axis	ISA[ISPA]-MXM-□-100-20/10/5-(Stroke)-T1-B	P18

* In the above model name, □ indicates encoder type A (absolute) or I (incremental).



(Note 1) The stroke in the model is specified in cm (centimeters).
(Note 2) The cable length measures from the X-axis connector box to the controller. The standard lengths are 3m and 5m, but other lengths can also be specified in meters. The maximum length is 20m.
(Note 3) The rated acceleration is 0.3G. Increasing the acceleration will result in lower load capacity.
(Note 4) Please note that a longer stroke will result in a lower maximum speed.

* For other points to note, please refer to page 49.

ICSA3 [ICSPA3] -BC□HB2□

Load Capacity (kg) (Note3)

BC□HB2H

		Y-axis stroke				
		100	200	300	400	500
Z-axis stroke	100	3.5				
	200	3.5				
	300	3.5				
	400	3.5				

BC□HB2M

		Y-axis stroke				
		100	200	300	400	500
Z-axis stroke	100	9.0				
	200	9.0				8.4
	300	8.6			7.3	
	400	7.6		6.3		

BC□HB2L

		Y-axis stroke				
		100	200	300	400	500
Z-axis stroke	100	10.7				9.4
	200	9.7				8.4
	300	8.6			7.3	
	300	7.6		6.3		

Maximum Speed by Stroke (mm/sec) (Note4)

BC□HB2H

	Stroke							
	100	200	300	400	500	600	700	800
X-axis	1000							795
Y-axis	1000							
Z-axis	1000		-	-	-	-	-	-

BC□HB2M

	Stroke							
	100	200	300	400	500	600	700	800
X-axis	1000							795
Y-axis	1000							
Z-axis	500		-	-	-	-	-	-

BC□HB2L

	Stroke							
	100	200	300	400	500	600	700	800
X-axis	1000							795
Y-axis	1000							
Z-axis	250		-	-	-	-	-	-

Dimensions

* The dimension below is for XY-axis Configuration direction 1.

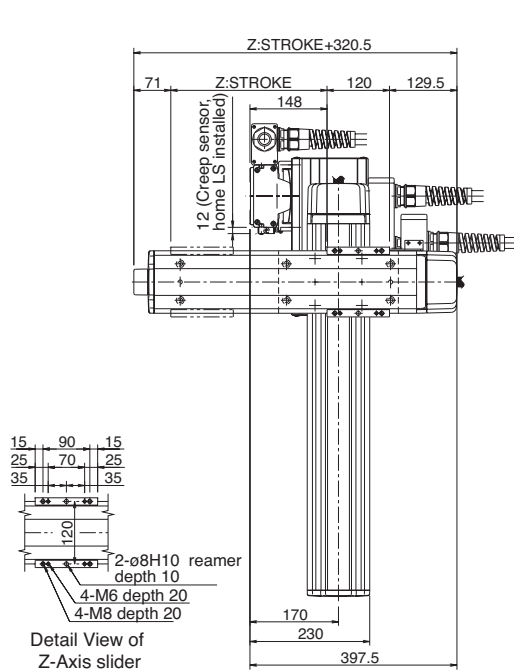

Detail View of Z-Axis slider

* The configuration position in the figure is home position. To change the home position, indicate NM in the option. Note that changing the home direction will require the actuator to be returned to IAI for adjustment.

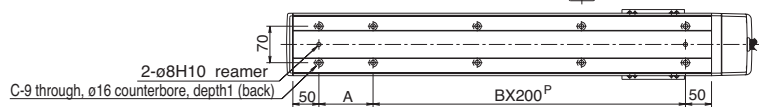
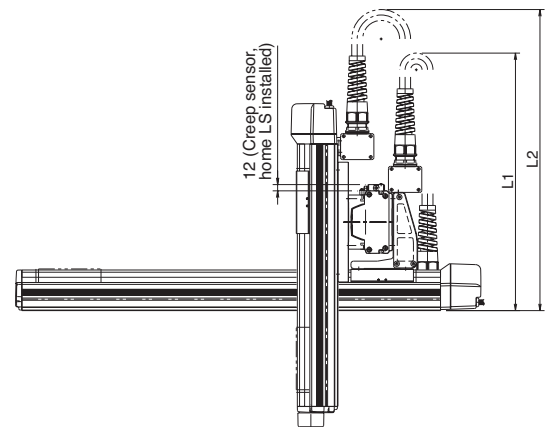
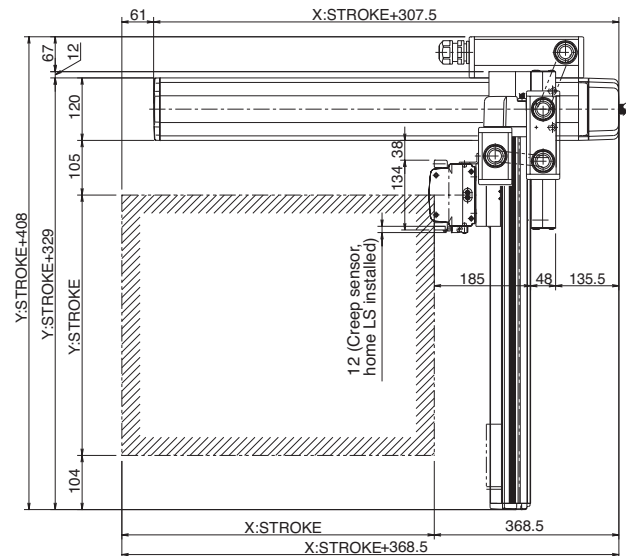

X stroke	200	300	400	500	600	700	800
L1	(550)	(600)	(650)	(700)	(750)	(800)	(850)
A	104	204	104	204	104	204	104
B	1	1	2	2	3	3	4
C	6	6	8	8	10	10	12

Y stroke	100	200	300	400	500
L2	(630)	(680)	(730)	(780)	(830)

ICSA3-BC **HB3**

Cartesian Robot: X-Y-Z 3-Axes Configuration
Z-Axis Base Mount Type

ICSPA3-BC **HB3**

Cartesian Robot: X-Y-Z 3-Axes Configuration
Z-Axis Base Mount Type **High-Precision Specification**

Type XYB + Z-Axis Base Mount Type **Stroke** X-axis: 200-800mm Y-axis: 100-500mm Z-axis: 100-400mm **Load capacity** 10.7kg ~ 6.3kg

Model specification items Series - Type - Encoder type - X-axis stroke + options - Y-axis stroke + options - Z-axis stroke + options - Applicable controller - Cable length - Cable management
(Example) ICSA3 (ICSPA3) - BC1HB3M - A - 70AQL - 40AQL - 30BL - T1 - 5L - SC - SC

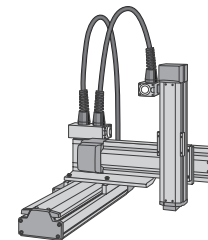

* Refer to page 51 for the details of model specification items.

Models/Specifications * [] is for the high-precision specification.

Encoder Type	XY-axis configuration direction (*1)	Z-axis type (*2)	Model
Absolute	1	H	ICSA3 [ICSPA3] -BC1HB3H-A- <input type="checkbox"/> - <input type="checkbox"/> - <input type="checkbox"/> -B-T1- <input type="checkbox"/> - <input type="checkbox"/>
		M	ICSA3 [ICSPA3] -BC1HB3M-A- <input type="checkbox"/> - <input type="checkbox"/> - <input type="checkbox"/> -B-T1- <input type="checkbox"/> - <input type="checkbox"/>
	2	H	ICSA3 [ICSPA3] -BC2HB3H-A- <input type="checkbox"/> - <input type="checkbox"/> - <input type="checkbox"/> -B-T1- <input type="checkbox"/> - <input type="checkbox"/>
		M	ICSA3 [ICSPA3] -BC2HB3M-A- <input type="checkbox"/> - <input type="checkbox"/> - <input type="checkbox"/> -B-T1- <input type="checkbox"/> - <input type="checkbox"/>
	3	H	ICSA3 [ICSPA3] -BC3HB3H-A- <input type="checkbox"/> - <input type="checkbox"/> - <input type="checkbox"/> -B-T1- <input type="checkbox"/> - <input type="checkbox"/>
		M	ICSA3 [ICSPA3] -BC3HB3M-A- <input type="checkbox"/> - <input type="checkbox"/> - <input type="checkbox"/> -B-T1- <input type="checkbox"/> - <input type="checkbox"/>
	4	H	ICSA3 [ICSPA3] -BC4HB3H-A- <input type="checkbox"/> - <input type="checkbox"/> - <input type="checkbox"/> -B-T1- <input type="checkbox"/> - <input type="checkbox"/>
		M	ICSA3 [ICSPA3] -BC4HB3M-A- <input type="checkbox"/> - <input type="checkbox"/> - <input type="checkbox"/> -B-T1- <input type="checkbox"/> - <input type="checkbox"/>
Incremental	1	H	ICSA3 [ICSPA3] -BC1HB3H-I- <input type="checkbox"/> - <input type="checkbox"/> - <input type="checkbox"/> -B-T1- <input type="checkbox"/> - <input type="checkbox"/>
		M	ICSA3 [ICSPA3] -BC1HB3M-I- <input type="checkbox"/> - <input type="checkbox"/> - <input type="checkbox"/> -B-T1- <input type="checkbox"/> - <input type="checkbox"/>
	2	H	ICSA3 [ICSPA3] -BC2HB3H-I- <input type="checkbox"/> - <input type="checkbox"/> - <input type="checkbox"/> -B-T1- <input type="checkbox"/> - <input type="checkbox"/>
		M	ICSA3 [ICSPA3] -BC2HB3M-I- <input type="checkbox"/> - <input type="checkbox"/> - <input type="checkbox"/> -B-T1- <input type="checkbox"/> - <input type="checkbox"/>
	3	H	ICSA3 [ICSPA3] -BC3HB3H-I- <input type="checkbox"/> - <input type="checkbox"/> - <input type="checkbox"/> -B-T1- <input type="checkbox"/> - <input type="checkbox"/>
		M	ICSA3 [ICSPA3] -BC3HB3M-I- <input type="checkbox"/> - <input type="checkbox"/> - <input type="checkbox"/> -B-T1- <input type="checkbox"/> - <input type="checkbox"/>
	4	H	ICSA3 [ICSPA3] -BC4HB3H-I- <input type="checkbox"/> - <input type="checkbox"/> - <input type="checkbox"/> -B-T1- <input type="checkbox"/> - <input type="checkbox"/>
		M	ICSA3 [ICSPA3] -BC4HB3M-I- <input type="checkbox"/> - <input type="checkbox"/> - <input type="checkbox"/> -B-T1- <input type="checkbox"/> - <input type="checkbox"/>

*1: Refer to the figure below for XY-axis configuration direction.
*2: The load capacity and the maximum speed may vary depending on the type of Z-axis.
Note: T1 in the above models will be T2 when operated with XSEL-P/Q type.

Explanation of Model Code

Number	Contents	Specification
<input type="checkbox"/>	X-axis stroke (Note 1)	20 : 200mm ~ 80 : 800mm
<input type="checkbox"/>	Y-axis stroke (Note 1)	10 : 100mm ~ 50 : 500mm
<input type="checkbox"/>	Z-axis stroke (Note 1)	10 : 100mm ~ 40 : 400mm
<input type="checkbox"/>	Cable length (Note 2)	3L : 3m 5L : 5m
<input type="checkbox"/>	Y-axis/ Z-axis cable management	SC-SC : Self-standing cable management CT-CT : Cable track

* The above explains the Models/Specifications chart to the left.

Options

Please add the option codes at the end of each stroke of the axis.
When adding multiple options, put together in alphabetic order.

Name	Code	Page
AQ seal	AQ	P13
Brake	B	P13
Creep sensor	C	P13
Home limit switch	L	P14
Reversed-home specification	NM	P14
Guide with ball-retaining mechanism	RT	P14

Configuration Direction

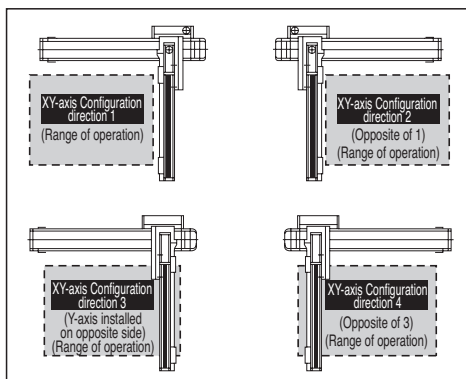

Common Specifications * [] is for the high-precision specification.

Drive system	Ball screw, rolled C10 [equivalent to rolled C5]
Positioning repeatability	±0.02mm [±0.01mm]
Backlash	0.05mm or less [0.02mm or less]
Guide	Integrated with base
Base	Material: Aluminum with white alumite treatment
X-axis motor output / lead	200W / 20mm
Y-axis motor output / lead	100W / 20mm
Z-axis motor output / lead	200W / 20mm (H), 10mm (M)

Applicable Controller Specifications

Refer to page 65 for System Configuration.

Axis Configuration * [] is for the high-precision specification.

Axis Type	Model	Page
X-axis	ISA[ISPA]-MXM- <input type="checkbox"/> -200-20-(Stroke)-T1	P19
Y-axis	ISA[ISPA]-MYM- <input type="checkbox"/> -100-20-(Stroke)-T1	P21
Z-axis	ISA[ISPA]-MXM- <input type="checkbox"/> -200-20/10-(Stroke)-T1-B	P19

*In the above model name, indicates encoder type A (absolute) or I (incremental).



Caution

(Note 1) The stroke in the model is specified in cm (centimeters).
(Note 2) The cable length measures from the X-axis connector box to the controller. The standard lengths are 3m and 5m, but other lengths can also be specified in meters. The maximum length is 20m.
(Note 3) The rated acceleration is 0.3G. Increasing the acceleration will result in lower load capacity.
(Note 4) Please note that a longer stroke will result in a lower maximum speed.

* For other points to note, please refer to page 49.

ICSA3 [ICSPA3] -BC□HB3□

Load Capacity (kg) (Note3)

BC□HB3H

		Y-axis stroke				
		100	200	300	400	500
Z-axis stroke	100	9.0				
	200	9.0			8.4	
	300	8.6			7.3	
	400	7.6			6.3	

BC□HB3M

		Y-axis stroke				
		100	200	300	400	500
Z-axis stroke	100	10.7			9.4	
	200	9.7			8.4	
	300	8.6			7.3	
	400	7.6			6.3	

Maximum Speed by Stroke (mm/sec) (Note4)

BC□HB3H

	Stroke							
	100	200	300	400	500	600	700	800
X-axis	1000							795
Y-axis	1000				-		-	
Z-axis	1000		-		-		-	

BC□HB3M

	Stroke							
	100	200	300	400	500	600	700	800
X-axis	1000							795
Y-axis	1000				-		-	
Z-axis	500		-		-		-	

Dimensions * The dimension below is for XY-axis Configuration direction 1.

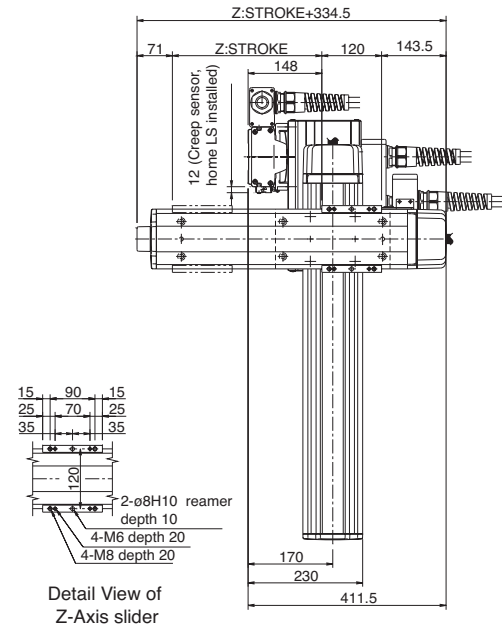

Detail View of Z-Axis slider

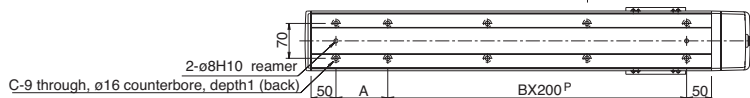
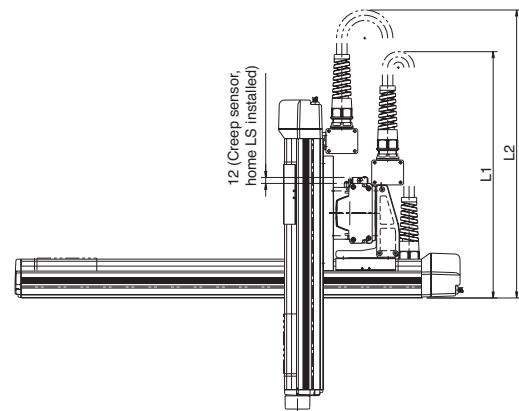
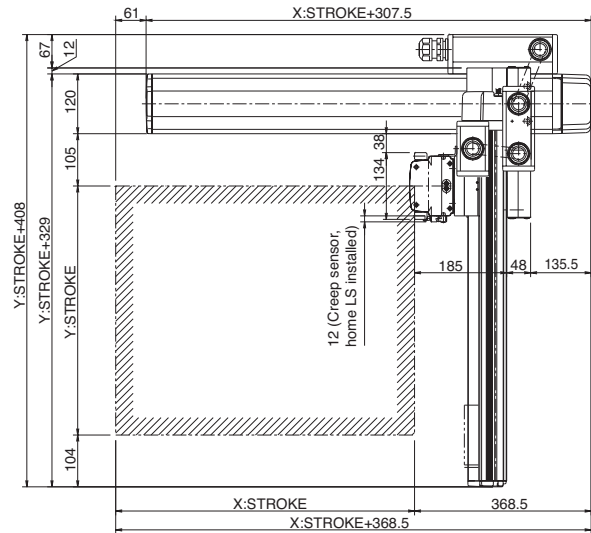

* The configuration position in the figure is home position. To change the home position, indicate NM in the option. Note that changing the home direction will require the actuator to be returned to IAI for adjustment.

X stroke	200	300	400	500	600	700	800
L1	(550)	(600)	(650)	(700)	(750)	(800)	(850)
A	104	204	104	204	104	204	104
B	1	1	2	2	3	3	4
C	6	6	8	8	10	10	12

Y stroke	100	200	300	400	500
L2	(630)	(680)	(730)	(780)	(830)

ICSA3-BC **MB1**

Cartesian Robot: X-Y-Z 3-Axes Configuration
Z-axis Base Mount Type

ICSPA3-BC **MB1**

Cartesian Robot: X-Y-Z 3-Axes Configuration
Z-axis Base Mount Type **High-Precision Specification**

Type XYB + Z-axis Base Mount Type Stroke X-axis: 200-800mm Y-axis: 100-500mm Z-axis: 100-400mm Load capacity 14kg ~ 3kg

Model specification items Series - Type - Encoder type - X-axis stroke + options - Y-axis stroke + options - Z-axis stroke + options - Applicable controller - Cable length - Cable management
(Example) ICSA3 (ICSPA3) - BC1MB1M - A - 70AQL - 40AQL - 30BL - T1 - 5L - SC-SC

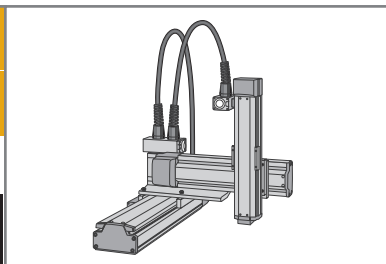

* Refer to page 51 for the details of model specification items.

Models/Specifications * [] is for the high-precision specification.

Encoder Type	XY-axis configuration direction (*1)	Z-axis type (*2)	Model
Absolute	1	H	ICSA3 [ICSPA3] -BC1MB1H-A- <input type="checkbox"/> - <input type="checkbox"/> - <input type="checkbox"/> -B-T1- <input type="checkbox"/> - <input type="checkbox"/>
		M	ICSA3 [ICSPA3] -BC1MB1M-A- <input type="checkbox"/> - <input type="checkbox"/> - <input type="checkbox"/> -B-T1- <input type="checkbox"/> - <input type="checkbox"/>
		L	ICSA3 [ICSPA3] -BC1MB1L-A- <input type="checkbox"/> - <input type="checkbox"/> - <input type="checkbox"/> -B-T1- <input type="checkbox"/> - <input type="checkbox"/>
	2	H	ICSA3 [ICSPA3] -BC2MB1H-A- <input type="checkbox"/> - <input type="checkbox"/> - <input type="checkbox"/> -B-T1- <input type="checkbox"/> - <input type="checkbox"/>
		M	ICSA3 [ICSPA3] -BC2MB1M-A- <input type="checkbox"/> - <input type="checkbox"/> - <input type="checkbox"/> -B-T1- <input type="checkbox"/> - <input type="checkbox"/>
		L	ICSA3 [ICSPA3] -BC2MB1L-A- <input type="checkbox"/> - <input type="checkbox"/> - <input type="checkbox"/> -B-T1- <input type="checkbox"/> - <input type="checkbox"/>
	3	H	ICSA3 [ICSPA3] -BC3MB1H-A- <input type="checkbox"/> - <input type="checkbox"/> - <input type="checkbox"/> -B-T1- <input type="checkbox"/> - <input type="checkbox"/>
		M	ICSA3 [ICSPA3] -BC3MB1M-A- <input type="checkbox"/> - <input type="checkbox"/> - <input type="checkbox"/> -B-T1- <input type="checkbox"/> - <input type="checkbox"/>
		L	ICSA3 [ICSPA3] -BC3MB1L-A- <input type="checkbox"/> - <input type="checkbox"/> - <input type="checkbox"/> -B-T1- <input type="checkbox"/> - <input type="checkbox"/>
	4	H	ICSA3 [ICSPA3] -BC4MB1H-A- <input type="checkbox"/> - <input type="checkbox"/> - <input type="checkbox"/> -B-T1- <input type="checkbox"/> - <input type="checkbox"/>
		M	ICSA3 [ICSPA3] -BC4MB1M-A- <input type="checkbox"/> - <input type="checkbox"/> - <input type="checkbox"/> -B-T1- <input type="checkbox"/> - <input type="checkbox"/>
		L	ICSA3 [ICSPA3] -BC4MB1L-A- <input type="checkbox"/> - <input type="checkbox"/> - <input type="checkbox"/> -B-T1- <input type="checkbox"/> - <input type="checkbox"/>
Incremental	1	H	ICSA3 [ICSPA3] -BC1MB1H-I- <input type="checkbox"/> - <input type="checkbox"/> - <input type="checkbox"/> -B-T1- <input type="checkbox"/> - <input type="checkbox"/>
		M	ICSA3 [ICSPA3] -BC1MB1M-I- <input type="checkbox"/> - <input type="checkbox"/> - <input type="checkbox"/> -B-T1- <input type="checkbox"/> - <input type="checkbox"/>
		L	ICSA3 [ICSPA3] -BC1MB1L-I- <input type="checkbox"/> - <input type="checkbox"/> - <input type="checkbox"/> -B-T1- <input type="checkbox"/> - <input type="checkbox"/>
	2	H	ICSA3 [ICSPA3] -BC2MB1H-I- <input type="checkbox"/> - <input type="checkbox"/> - <input type="checkbox"/> -B-T1- <input type="checkbox"/> - <input type="checkbox"/>
		M	ICSA3 [ICSPA3] -BC2MB1M-I- <input type="checkbox"/> - <input type="checkbox"/> - <input type="checkbox"/> -B-T1- <input type="checkbox"/> - <input type="checkbox"/>
		L	ICSA3 [ICSPA3] -BC2MB1L-I- <input type="checkbox"/> - <input type="checkbox"/> - <input type="checkbox"/> -B-T1- <input type="checkbox"/> - <input type="checkbox"/>
	3	H	ICSA3 [ICSPA3] -BC3MB1H-I- <input type="checkbox"/> - <input type="checkbox"/> - <input type="checkbox"/> -B-T1- <input type="checkbox"/> - <input type="checkbox"/>
		M	ICSA3 [ICSPA3] -BC3MB1M-I- <input type="checkbox"/> - <input type="checkbox"/> - <input type="checkbox"/> -B-T1- <input type="checkbox"/> - <input type="checkbox"/>
		L	ICSA3 [ICSPA3] -BC3MB1L-I- <input type="checkbox"/> - <input type="checkbox"/> - <input type="checkbox"/> -B-T1- <input type="checkbox"/> - <input type="checkbox"/>
	4	H	ICSA3 [ICSPA3] -BC4MB1H-I- <input type="checkbox"/> - <input type="checkbox"/> - <input type="checkbox"/> -B-T1- <input type="checkbox"/> - <input type="checkbox"/>
		M	ICSA3 [ICSPA3] -BC4MB1M-I- <input type="checkbox"/> - <input type="checkbox"/> - <input type="checkbox"/> -B-T1- <input type="checkbox"/> - <input type="checkbox"/>
		L	ICSA3 [ICSPA3] -BC4MB1L-I- <input type="checkbox"/> - <input type="checkbox"/> - <input type="checkbox"/> -B-T1- <input type="checkbox"/> - <input type="checkbox"/>

*1: Refer to the figure below for XY-axis configuration direction.
*2: The load capacity and the maximum speed may vary depending on the type of Z-axis.
Note: T1 in the above models will be T2 when operated with XSEL-P/Q type.

Explanation of Model Code

Number	Contents	Specification
①	X-axis stroke (Note 1)	20 : 200mm ~ 80 : 800mm
②	Y-axis stroke (Note 1)	10 : 100mm ~ 50 : 500mm
③	Z-axis stroke (Note 1)	10 : 100mm ~ 40 : 400mm
④	Cable length (Note 2)	3L : 3m 5L : 5m
⑤	Y-axis/ Z-axis cable management	SC-SC : Self-standing cable CT-CT : Cable track

* The above explains the Models/Specifications chart to the left.

Options

Please add the option codes at the end of each stroke of the axis.
When adding multiple options, put together in alphabetic order.

Name	Code	Page
AQ seal	AQ	P13
Brake	B	P13
Creep sensor	C	P13
Home limit switch	L	P14
Reversed-home specification	NM	P14
Guide with ball-retaining mechanism	RT	P14

Configuration Direction

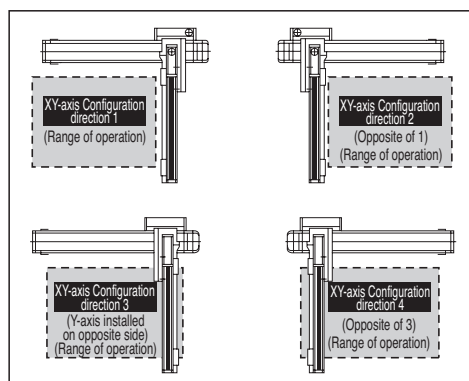

Common Specifications * [] is for the high-precision specification.

Drive system	Ball screw, rolled C10 [equivalent to rolled C5]
Positioning repeatability	±0.02mm [±0.01mm]
Backlash	0.05mm or less [0.02mm or less]
Guide	Integrated with base
Base	Material: Aluminum with white alumite treatment
X-axis motor output / lead	100W / 10mm
Y-axis motor output / lead	100W / 10mm
Z-axis motor output / lead	60W / 16mm (H), 8mm (M), 4mm (L)

Applicable Controller Specifications

Refer to page 65 for System Configuration.

Axis Configuration * [] is for the high-precision specification.

Axis Type	Model	Page
X-axis	ISA[ISPA]-MXM-□-100-10-(Stroke)-T1	P18
Y-axis	ISA[ISPA]-MYM-□-100-10-(Stroke)-T1	P21
Z-axis	ISA[ISPA]-SXM-□-60-16/8/4-(Stroke)-T1-B	P15

* In the above model name, □ indicates encoder type A (absolute) or I (incremental).



Caution

(Note 1) The stroke in the model is specified in cm (centimeters).
(Note 2) The cable length measures from the X-axis connector box to the controller. The standard lengths are 3m and 5m, but other lengths can also be specified in meters. The maximum length is 20m.
(Note 3) The rated acceleration is 0.3G. Increasing the acceleration will result in lower load capacity.
(Note 4) Please note that a longer stroke will result in a lower maximum speed.

* For other points to note, please refer to page 49.

ICSA3 [ICSPA3] -BC□MB1□

Load Capacity (kg) (Note3)

BC□MB1H

		Y-axis stroke				
		100	200	300	400	500
Z-axis stroke	100	3.0				
	200	3.0				
	300	3.0				
	400	3.0				

BC□MB1M

		Y-axis stroke				
		100	200	300	400	500
Z-axis stroke	100	6.0				
	200	6.0				
	300	6.0				
	400	6.0				

BC□MB1L

		Y-axis stroke				
		100	200	300	400	500
Z-axis stroke	100	14.0				13.5
	200	14.0				12.9
	300	14.0				12.3
	300	13.5				11.7

Maximum Speed by Stroke (mm/sec) (Note4)

BC□MB1H

	Stroke								
	100	200	300	400	500	600	700	800	
X-axis	-	500					480		380
Y-axis	500				-	-	-	-	-
Z-axis	800		-	-	-	-	-	-	-

BC□MB1M

	Stroke								
	100	200	300	400	500	600	700	800	
X-axis	-	500					480		380
Y-axis	500				-	-	-	-	-
Z-axis	400		-	-	-	-	-	-	-

BC□MB1L

	Stroke								
	100	200	300	400	500	600	700	800	
X-axis	-	500					480		380
Y-axis	500				-	-	-	-	-
Z-axis	200		-	-	-	-	-	-	-

Dimensions

* The dimension below is for XY-axis Configuration direction 1.

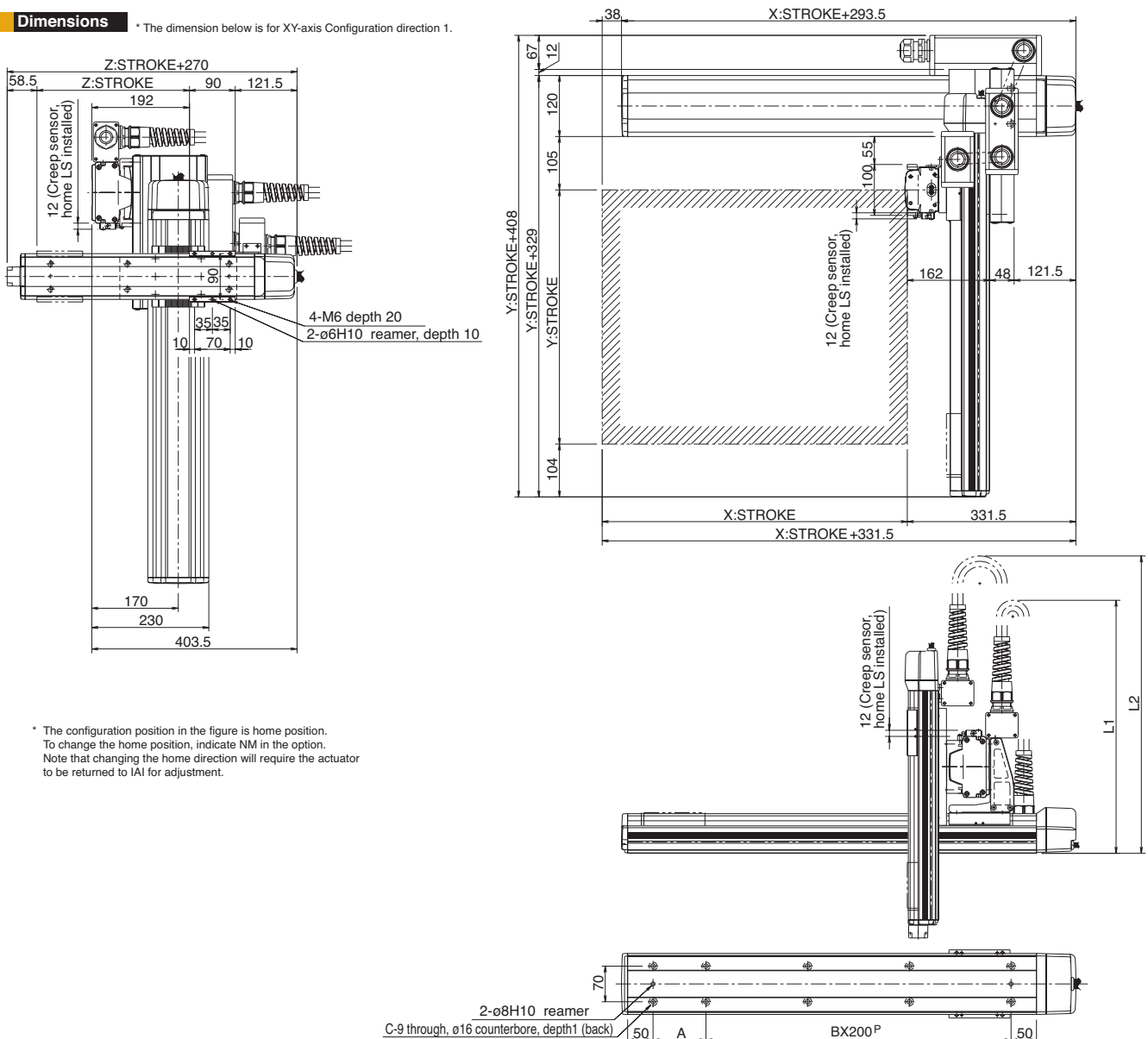

* The configuration position in the figure is home position. To change the home position, indicate NM in the option. Note that changing the home direction will require the actuator to be returned to IAI for adjustment.

X stroke	200	300	400	500	600	700	800
L1	(550)	(600)	(650)	(700)	(750)	(800)	(850)
A	104	204	104	204	104	204	104
B	1	1	2	2	3	3	4
C	6	6	8	8	10	10	12

Y stroke	100	200	300	400	500
L2	(630)	(680)	(730)	(780)	(830)

ICSA3-BC **MB2** Cartesian Robot: X-Y-Z 3-Axes Configuration
Z-axis Base Mount Type

ICSPA3-BC **MB2** Cartesian Robot: X-Y-Z 3-Axes Configuration
Z-axis Base Mount Type High-Precision Specification

Type XYB + Z-axis Base Mount Type Stroke X-axis: 200-800mm Y-axis: 100-500mm Z-axis: 100-400mm Load capacity 19kg ~ 3.5kg

Model specification items Series Type Encoder type X-axis stroke + options Y-axis stroke + options Z-axis stroke + options Applicable controller Cable length Cable management
(Example) ICSA3 [ICSPA3] - BC1MB2M - A - 70AQL - 40AQL - 30BL - T1 - 5L - SC-SC

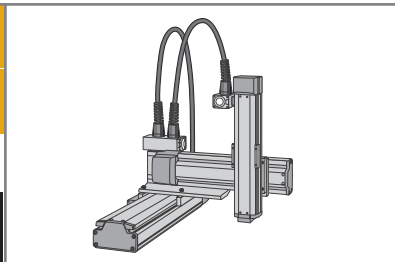

* Refer to page 51 for the details of model specification items.

Models/Specifications * [] is for the high-precision specification.

Encoder Type	XY-axis configuration direction (*1)	Z-axis type (*2)	Model
Absolute	1	H	ICSA3 [ICSPA3] -BC1MB2H-A- <input type="checkbox"/> - <input type="checkbox"/> - <input type="checkbox"/> -B-T1- <input type="checkbox"/> - <input type="checkbox"/>
		M	ICSA3 [ICSPA3] -BC1MB2M-A- <input type="checkbox"/> - <input type="checkbox"/> - <input type="checkbox"/> -B-T1- <input type="checkbox"/> - <input type="checkbox"/>
		L	ICSA3 [ICSPA3] -BC1MB2L-A- <input type="checkbox"/> - <input type="checkbox"/> - <input type="checkbox"/> -B-T1- <input type="checkbox"/> - <input type="checkbox"/>
	2	H	ICSA3 [ICSPA3] -BC2MB2H-A- <input type="checkbox"/> - <input type="checkbox"/> - <input type="checkbox"/> -B-T1- <input type="checkbox"/> - <input type="checkbox"/>
		M	ICSA3 [ICSPA3] -BC2MB2M-A- <input type="checkbox"/> - <input type="checkbox"/> - <input type="checkbox"/> -B-T1- <input type="checkbox"/> - <input type="checkbox"/>
		L	ICSA3 [ICSPA3] -BC2MB2L-A- <input type="checkbox"/> - <input type="checkbox"/> - <input type="checkbox"/> -B-T1- <input type="checkbox"/> - <input type="checkbox"/>
	3	H	ICSA3 [ICSPA3] -BC3MB2H-A- <input type="checkbox"/> - <input type="checkbox"/> - <input type="checkbox"/> -B-T1- <input type="checkbox"/> - <input type="checkbox"/>
		M	ICSA3 [ICSPA3] -BC3MB2M-A- <input type="checkbox"/> - <input type="checkbox"/> - <input type="checkbox"/> -B-T1- <input type="checkbox"/> - <input type="checkbox"/>
		L	ICSA3 [ICSPA3] -BC3MB2L-A- <input type="checkbox"/> - <input type="checkbox"/> - <input type="checkbox"/> -B-T1- <input type="checkbox"/> - <input type="checkbox"/>
	4	H	ICSA3 [ICSPA3] -BC4MB2H-A- <input type="checkbox"/> - <input type="checkbox"/> - <input type="checkbox"/> -B-T1- <input type="checkbox"/> - <input type="checkbox"/>
		M	ICSA3 [ICSPA3] -BC4MB2M-A- <input type="checkbox"/> - <input type="checkbox"/> - <input type="checkbox"/> -B-T1- <input type="checkbox"/> - <input type="checkbox"/>
		L	ICSA3 [ICSPA3] -BC4MB2L-A- <input type="checkbox"/> - <input type="checkbox"/> - <input type="checkbox"/> -B-T1- <input type="checkbox"/> - <input type="checkbox"/>
Incremental	1	H	ICSA3 [ICSPA3] -BC1MB2H-I- <input type="checkbox"/> - <input type="checkbox"/> - <input type="checkbox"/> -B-T1- <input type="checkbox"/> - <input type="checkbox"/>
		M	ICSA3 [ICSPA3] -BC1MB2M-I- <input type="checkbox"/> - <input type="checkbox"/> - <input type="checkbox"/> -B-T1- <input type="checkbox"/> - <input type="checkbox"/>
		L	ICSA3 [ICSPA3] -BC1MB2L-I- <input type="checkbox"/> - <input type="checkbox"/> - <input type="checkbox"/> -B-T1- <input type="checkbox"/> - <input type="checkbox"/>
	2	H	ICSA3 [ICSPA3] -BC2MB2H-I- <input type="checkbox"/> - <input type="checkbox"/> - <input type="checkbox"/> -B-T1- <input type="checkbox"/> - <input type="checkbox"/>
		M	ICSA3 [ICSPA3] -BC2MB2M-I- <input type="checkbox"/> - <input type="checkbox"/> - <input type="checkbox"/> -B-T1- <input type="checkbox"/> - <input type="checkbox"/>
		L	ICSA3 [ICSPA3] -BC2MB2L-I- <input type="checkbox"/> - <input type="checkbox"/> - <input type="checkbox"/> -B-T1- <input type="checkbox"/> - <input type="checkbox"/>
	3	H	ICSA3 [ICSPA3] -BC3MB2H-I- <input type="checkbox"/> - <input type="checkbox"/> - <input type="checkbox"/> -B-T1- <input type="checkbox"/> - <input type="checkbox"/>
		M	ICSA3 [ICSPA3] -BC3MB2M-I- <input type="checkbox"/> - <input type="checkbox"/> - <input type="checkbox"/> -B-T1- <input type="checkbox"/> - <input type="checkbox"/>
		L	ICSA3 [ICSPA3] -BC3MB2L-I- <input type="checkbox"/> - <input type="checkbox"/> - <input type="checkbox"/> -B-T1- <input type="checkbox"/> - <input type="checkbox"/>
	4	H	ICSA3 [ICSPA3] -BC4MB2H-I- <input type="checkbox"/> - <input type="checkbox"/> - <input type="checkbox"/> -B-T1- <input type="checkbox"/> - <input type="checkbox"/>
		M	ICSA3 [ICSPA3] -BC4MB2M-I- <input type="checkbox"/> - <input type="checkbox"/> - <input type="checkbox"/> -B-T1- <input type="checkbox"/> - <input type="checkbox"/>
		L	ICSA3 [ICSPA3] -BC4MB2L-I- <input type="checkbox"/> - <input type="checkbox"/> - <input type="checkbox"/> -B-T1- <input type="checkbox"/> - <input type="checkbox"/>

*1: Refer to the figure below for XY-axis configuration direction.
*2: The load capacity and the maximum speed may vary depending on the type of Z-axis.
Note: T1 in the above models will be T2 when operated with XSEL-P/Q type.

Explanation of Model Code

Number	Contents	Specification
①	X-axis stroke (Note 1)	20 : 200mm ~ 80 : 800mm
②	Y-axis stroke (Note 1)	10 : 100mm ~ 50 : 500mm
③	Z-axis stroke (Note 1)	10 : 100mm ~ 40 : 400mm
④	Cable length (Note 2)	3L : 3m 5L : 5m
⑤	Y-axis/ Z-axis cable management	SC-SC : Self-standing cable CT-CT : Cable track

* The above explains the Models/Specifications chart to the left.

Options

Please add the option codes at the end of each stroke of the axis. When adding multiple options, put together in alphabetic order.

Name	Code	Page
AQ seal	AQ	P13
Brake	B	P13
Creep sensor	C	P13
Home limit switch	L	P14
Reversed-home specification	NM	P14
Guide with ball-retaining mechanism	RT	P14

Configuration Direction

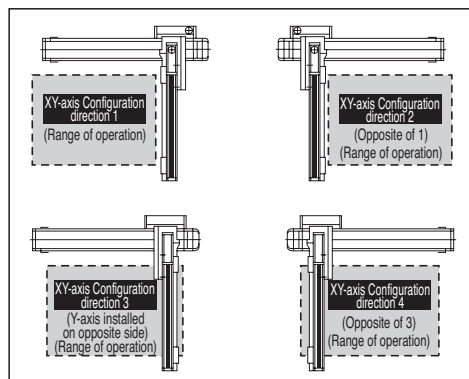

Common Specifications * [] is for the high-precision specification.

Drive system	Ball screw, rolled C10 [equivalent to rolled C5]
Positioning repeatability	±0.02mm [±0.01mm]
Backlash	0.05mm or less [0.02mm or less]
Guide	Integrated with base
Base	Material: Aluminum with white alumite treatment
X-axis motor output / lead	100W / 10mm
Y-axis motor output / lead	100W / 10mm
Z-axis motor output / lead	100W / 20mm (H), 10mm (M), 5mm (L)

Applicable Controller Specifications

Refer to page 65 for System Configuration.

Axis Configuration * [] is for the high-precision specification.

Axis Type	Model	Page
X-axis	ISA[ISPA]-MXM-□-100-10-(Stroke)-T1	P18
Y-axis	ISA[ISPA]-MYM-□-100-10-(Stroke)-T1	P21
Z-axis	ISA[ISPA]-MXM-□-100-20/10/5-(Stroke)-T1-B	P18

* In the above model name, □ indicates encoder type A (absolute) or I (incremental).



Caution

(Note 1) The stroke in the model is specified in cm (centimeters).
(Note 2) The cable length measures from the X-axis connector box to the controller. The standard lengths are 3m and 5m, but other lengths can also be specified in meters. The maximum length is 20m.
(Note 3) The rated acceleration is 0.3G. Increasing the acceleration will result in lower load capacity.
(Note 4) Please note that a longer stroke will result in a lower maximum speed.

* For other points to note, please refer to page 49.

ICSA3 [ICSPA3] -BC□MB2□

Load Capacity (kg) (Note3)

BC□MB2H

		Y-axis stroke				
		100	200	300	400	500
Z-axis stroke	100	3.5				
	200	3.5				
	300	3.5				
	400	3.5				

BC□MB2M

		Y-axis stroke				
		100	200	300	400	500
Z-axis stroke	100	9.0				
	200	9.0			8.4	
	300	9.0			7.3	
	400	9.0			6.3	

BC□MB2L

		Y-axis stroke				
		100	200	300	400	500
Z-axis stroke	100	19.0	18.5	17.5	12.5	9.4
	200	18.5	17.5	16.5	11.5	8.4
	300	17.4	16.4	15.4	10.4	7.3
	400	16.4	15.4	14.4	9.4	6.3

Maximum Speed by Stroke (mm/sec) (Note4)

BC□MB2H

	Stroke								
	100	200	300	400	500	600	700	800	
X-axis	-	500					480		380
Y-axis	500					-	-	-	-
Z-axis	1000		-	-	-	-	-	-	

BC□MB2M

	Stroke								
	100	200	300	400	500	600	700	800	
X-axis	-	500					480		380
Y-axis	500					-	-	-	
Z-axis	500		-	-	-	-	-		

BC□MB2L

	Stroke								
	100	200	300	400	500	600	700	800	
X-axis	-	500					480		380
Y-axis	500					-	-	-	
Z-axis	250		-	-	-	-	-		

Dimensions

* The dimension below is for XY-axis Configuration direction 1.

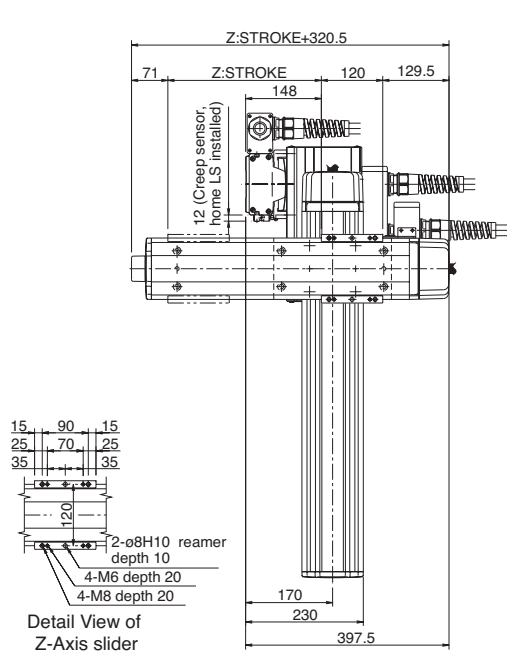

* The configuration position in the figure is home position. To change the home position, indicate NM in the option. Note that changing the home direction will require the actuator to be returned to IAI for adjustment.

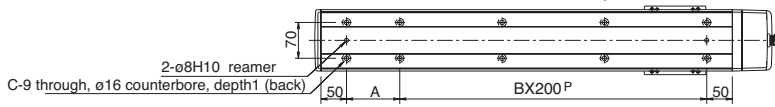
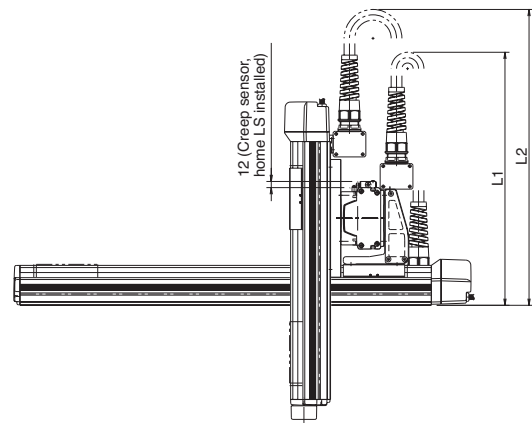
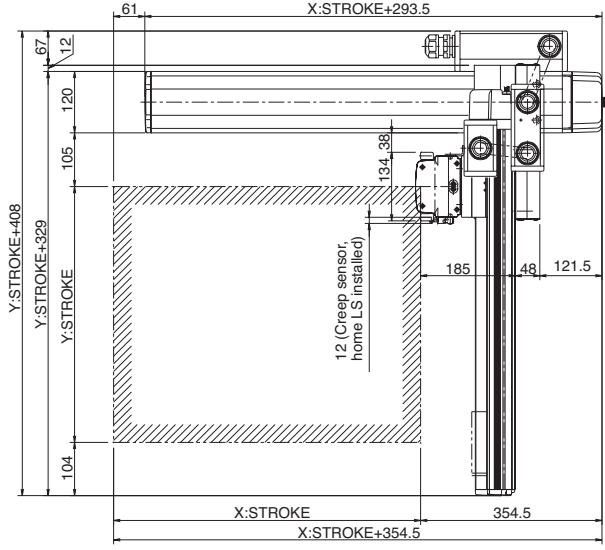

X stroke	200	300	400	500	600	700	800
L1	(550)	(600)	(650)	(700)	(750)	(800)	(850)
A	104	204	104	204	104	204	104
B	1	1	2	2	3	3	4
C	6	6	8	8	10	10	12

Y stroke	100	200	300	400	500
L2	(630)	(680)	(730)	(780)	(830)

ICSA3-BC **MB3**

Cartesian Robot: X-Y-Z 3-Axes Configuration
Z-axis Base Mount Type

ICSPA3-BC **MB3**

Cartesian Robot: X-Y-Z 3-Axes Configuration
Z-axis Base Mount Type **High-Precision Specification**

Type XYB + Z-axis Base Mount Type Stroke X-axis: 200-800mm Y-axis: 100-500mm Z-axis: 100-400mm Load capacity 19kg ~ 6.3kg

Model specification items Series Type Encoder type X-axis stroke + options Y-axis stroke + options Z-axis stroke + options Applicable controller Cable length Cable management
(Example) ICSA3 (ICSPA3) - BC1MB3M - A - 70AQL - 40AQL - 30BL - T1 - 5L - SC - SC

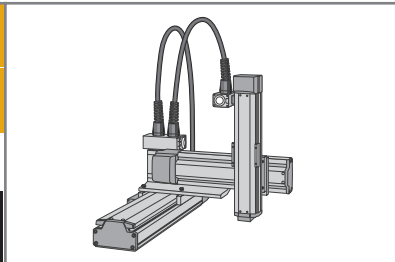

* Refer to page 51 for the details of model specification items.

Models/Specifications

* [] is for the high-precision specification.

Encoder Type	XY-axis configuration direction (*1)	Z-axis type (*2)	Model
Absolute	1	H	ICSA3 [ICSPA3] -BC1MB3H-A- <input type="checkbox"/> - <input type="checkbox"/> - <input type="checkbox"/> -B-T1- <input type="checkbox"/> - <input type="checkbox"/>
		M	ICSA3 [ICSPA3] -BC1MB3M-A- <input type="checkbox"/> - <input type="checkbox"/> - <input type="checkbox"/> -B-T1- <input type="checkbox"/> - <input type="checkbox"/>
	2	H	ICSA3 [ICSPA3] -BC2MB3H-A- <input type="checkbox"/> - <input type="checkbox"/> - <input type="checkbox"/> -B-T1- <input type="checkbox"/> - <input type="checkbox"/>
		M	ICSA3 [ICSPA3] -BC2MB3M-A- <input type="checkbox"/> - <input type="checkbox"/> - <input type="checkbox"/> -B-T1- <input type="checkbox"/> - <input type="checkbox"/>
	3	H	ICSA3 [ICSPA3] -BC3MB3H-A- <input type="checkbox"/> - <input type="checkbox"/> - <input type="checkbox"/> -B-T1- <input type="checkbox"/> - <input type="checkbox"/>
		M	ICSA3 [ICSPA3] -BC3MB3M-A- <input type="checkbox"/> - <input type="checkbox"/> - <input type="checkbox"/> -B-T1- <input type="checkbox"/> - <input type="checkbox"/>
	4	H	ICSA3 [ICSPA3] -BC4MB3H-A- <input type="checkbox"/> - <input type="checkbox"/> - <input type="checkbox"/> -B-T1- <input type="checkbox"/> - <input type="checkbox"/>
		M	ICSA3 [ICSPA3] -BC4MB3M-A- <input type="checkbox"/> - <input type="checkbox"/> - <input type="checkbox"/> -B-T1- <input type="checkbox"/> - <input type="checkbox"/>
Incremental	1	H	ICSA3 [ICSPA3] -BC1MB3H-I- <input type="checkbox"/> - <input type="checkbox"/> - <input type="checkbox"/> -B-T1- <input type="checkbox"/> - <input type="checkbox"/>
		M	ICSA3 [ICSPA3] -BC1MB3M-I- <input type="checkbox"/> - <input type="checkbox"/> - <input type="checkbox"/> -B-T1- <input type="checkbox"/> - <input type="checkbox"/>
	2	H	ICSA3 [ICSPA3] -BC2MB3H-I- <input type="checkbox"/> - <input type="checkbox"/> - <input type="checkbox"/> -B-T1- <input type="checkbox"/> - <input type="checkbox"/>
		M	ICSA3 [ICSPA3] -BC2MB3M-I- <input type="checkbox"/> - <input type="checkbox"/> - <input type="checkbox"/> -B-T1- <input type="checkbox"/> - <input type="checkbox"/>
	3	H	ICSA3 [ICSPA3] -BC3MB3H-I- <input type="checkbox"/> - <input type="checkbox"/> - <input type="checkbox"/> -B-T1- <input type="checkbox"/> - <input type="checkbox"/>
		M	ICSA3 [ICSPA3] -BC3MB3M-I- <input type="checkbox"/> - <input type="checkbox"/> - <input type="checkbox"/> -B-T1- <input type="checkbox"/> - <input type="checkbox"/>
	4	H	ICSA3 [ICSPA3] -BC4MB3H-I- <input type="checkbox"/> - <input type="checkbox"/> - <input type="checkbox"/> -B-T1- <input type="checkbox"/> - <input type="checkbox"/>
		M	ICSA3 [ICSPA3] -BC4MB3M-I- <input type="checkbox"/> - <input type="checkbox"/> - <input type="checkbox"/> -B-T1- <input type="checkbox"/> - <input type="checkbox"/>

*1: Refer to the figure below for XY-axis configuration direction.

*2: The load capacity and the maximum speed may vary depending on the type of Z-axis.
Note: T1 in the above models will be T2 when operated with XSEL-P/Q type.

Explanation of Model Code

Number	Contents	Specification
<input type="checkbox"/>	X-axis stroke (Note 1)	20 : 200mm ~ 80 : 800mm
<input type="checkbox"/>	Y-axis stroke (Note 1)	10 : 100mm ~ 50 : 500mm
<input type="checkbox"/>	Z-axis stroke (Note 1)	10 : 100mm ~ 40 : 400mm
<input type="checkbox"/>	Cable length (Note 2)	3L : 3m 5L : 5m
<input type="checkbox"/>	Y-axis/ Z-axis cable management	SC-SC : Self-standing cable CT-CT : Cable track

* The above explains the Models/Specifications chart to the left.

Options

Please add the option codes at the end of each stroke of the axis.
When adding multiple options, put together in alphabetic order.

Name	Code	Page
AQ seal	AQ	P13
Brake	B	P13
Creep sensor	C	P13
Home limit switch	L	P14
Reversed-home specification	NM	P14
Guide with ball-retaining mechanism	RT	P14

Configuration Direction

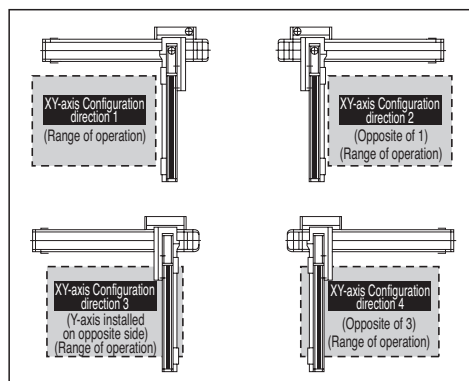

Common Specifications

* [] is for the high-precision specification.

Drive system	Ball screw, rolled C10 [equivalent to rolled C5]
Positioning repeatability	±0.02mm [±0.01mm]
Backlash	0.05mm or less [0.02mm or less]
Guide	Integrated with base
Base	Material: Aluminum with white alumite treatment
X-axis motor output / lead	100W / 10mm
Y-axis motor output / lead	100W / 10mm
Z-axis motor output / lead	200W / 20mm (H), 10mm (M)

Applicable Controller Specifications

Refer to page 65 for System Configuration.

Axis Configuration

* [] is for the high-precision specification.

Axis Type	Model	Page
X-axis	ISA[ISPA]-MXM- <input type="checkbox"/> -100-10-(Stroke)-T1	P18
Y-axis	ISA[ISPA]-MYM- <input type="checkbox"/> -100-10-(Stroke)-T1	P21
Z-axis	ISA[ISPA]-MXM- <input type="checkbox"/> -200-20/10-(Stroke)-T1-B	P19

*In the above model name, indicates encoder type A (absolute) or I (incremental).



Caution

(Note 1) The stroke in the model is specified in cm (centimeters).
(Note 2) The cable length measures from the X-axis connector box to the controller. The standard lengths are 3m and 5m, but other lengths can also be specified in meters. The maximum length is 20m.
(Note 3) The rated acceleration is 0.3G. Increasing the acceleration will result in lower load capacity.
(Note 4) Please note that a longer stroke will result in a lower maximum speed.

* For other points to note, please refer to page 49.

ICSA3 [ICSPA3] -BC□MB3□

Load Capacity (kg) (Note3)

BC□MB3H

		Y-axis stroke				
		100	200	300	400	500
Z-axis stroke	100	9.0				
	200	9.0			8.4	
	300	9.0			7.3	
	400	9.0			6.3	

BC□MB3M

		Y-axis stroke				
		100	200	300	400	500
Z-axis stroke	100	19.0	18.5	17.5	12.5	9.4
	200	18.5	17.5	16.5	11.5	8.4
	300	17.4	16.4	15.4	10.4	7.3
	400	16.4	15.4	14.4	9.4	6.3

Maximum Speed by Stroke (mm/sec) (Note4)

BC□MB3H

	Stroke								
	100	200	300	400	500	600	700	800	
X-axis	-	500					480	380	
Y-axis	500			-	-	-	-	-	
Z-axis	1000	-	-	-	-	-	-	-	

BC□MB3M

	Stroke								
	100	200	300	400	500	600	700	800	
X-axis	-	500					480	380	
Y-axis	500			-	-	-	-	-	
Z-axis	500	-	-	-	-	-	-	-	

Dimensions * The dimension below is for XY-axis Configuration direction 1.

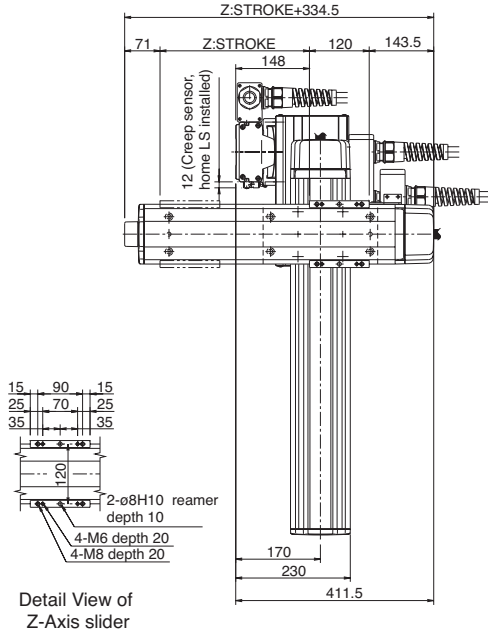

Detail View of Z-Axis slider

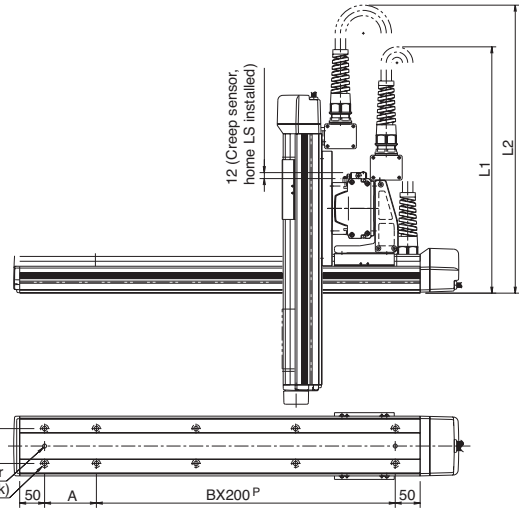
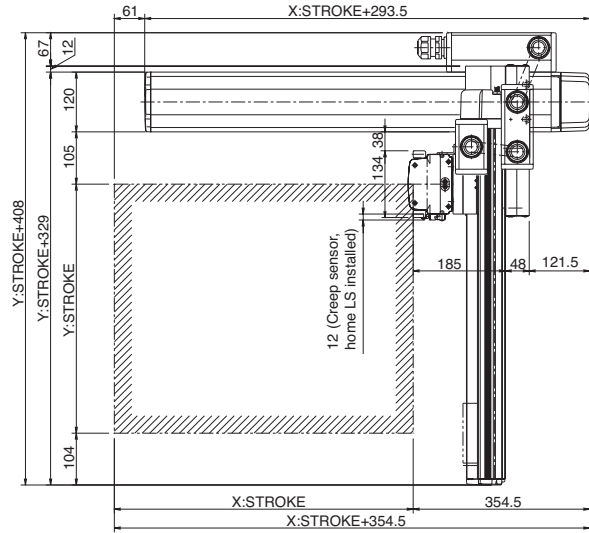

* The configuration position in the figure is home position. To change the home position, indicate NM in the option. Note that changing the home direction will require the actuator to be returned to IAI for adjustment.

X stroke	200	300	400	500	600	700	800
L1	(550)	(600)	(650)	(700)	(750)	(800)	(850)
A	104	204	104	204	104	204	104
B	1	1	2	2	3	3	4
C	6	6	8	8	10	10	12

Y stroke	100	200	300	400	500
L2	(630)	(680)	(730)	(780)	(830)

ICSA3-BD **HB1**

Cartesian Robot: X-Y-Z 3-Axes Configuration
Z-axis Base Mount Type

ICSPA3-BD **HB1**

Cartesian Robot: X-Y-Z 3-Axes Configuration
Z-axis Base Mount Type **High-Precision Specification**

Type XYB + Z-axis Base Mount Type Stroke X-axis: 800-2000mm Y-axis: 100-500mm Z-axis: 100-400mm Load capacity 14kg ~ 3kg

Model specification items Series - Type - Encoder type - X-axis stroke + options - Y-axis stroke + options - Z-axis stroke + options - Applicable controller - Cable length - Cable management
(Example) ICSA3 (ICSPA3) - BD1HB1M - A - 100AQL - 40AQL - 30BL - T1 - 5L - CT-SC

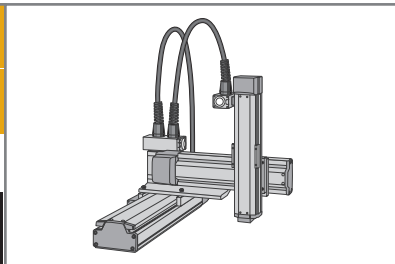

* Refer to page 51 for the details of model specification items.

Models/Specifications

* [] is for the high-precision specification.

Encoder Type	XY-axis configuration direction (*1)	Z-axis type (*2)	Model
Absolute	1	H	ICSA3 [ICSPA3] -BD1HB1H-A- <input type="checkbox"/> - <input type="checkbox"/> - <input type="checkbox"/> -B-T1- <input type="checkbox"/> - <input type="checkbox"/>
		M	ICSA3 [ICSPA3] -BD1HB1M-A- <input type="checkbox"/> - <input type="checkbox"/> - <input type="checkbox"/> -B-T1- <input type="checkbox"/> - <input type="checkbox"/>
		L	ICSA3 [ICSPA3] -BD1HB1L-A- <input type="checkbox"/> - <input type="checkbox"/> - <input type="checkbox"/> -B-T1- <input type="checkbox"/> - <input type="checkbox"/>
	2	H	ICSA3 [ICSPA3] -BD2HB1H-A- <input type="checkbox"/> - <input type="checkbox"/> - <input type="checkbox"/> -B-T1- <input type="checkbox"/> - <input type="checkbox"/>
		M	ICSA3 [ICSPA3] -BD2HB1M-A- <input type="checkbox"/> - <input type="checkbox"/> - <input type="checkbox"/> -B-T1- <input type="checkbox"/> - <input type="checkbox"/>
		L	ICSA3 [ICSPA3] -BD2HB1L-A- <input type="checkbox"/> - <input type="checkbox"/> - <input type="checkbox"/> -B-T1- <input type="checkbox"/> - <input type="checkbox"/>
	3	H	ICSA3 [ICSPA3] -BD3HB1H-A- <input type="checkbox"/> - <input type="checkbox"/> - <input type="checkbox"/> -B-T1- <input type="checkbox"/> - <input type="checkbox"/>
		M	ICSA3 [ICSPA3] -BD3HB1M-A- <input type="checkbox"/> - <input type="checkbox"/> - <input type="checkbox"/> -B-T1- <input type="checkbox"/> - <input type="checkbox"/>
		L	ICSA3 [ICSPA3] -BD3HB1L-A- <input type="checkbox"/> - <input type="checkbox"/> - <input type="checkbox"/> -B-T1- <input type="checkbox"/> - <input type="checkbox"/>
	4	H	ICSA3 [ICSPA3] -BD4HB1H-A- <input type="checkbox"/> - <input type="checkbox"/> - <input type="checkbox"/> -B-T1- <input type="checkbox"/> - <input type="checkbox"/>
		M	ICSA3 [ICSPA3] -BD4HB1M-A- <input type="checkbox"/> - <input type="checkbox"/> - <input type="checkbox"/> -B-T1- <input type="checkbox"/> - <input type="checkbox"/>
		L	ICSA3 [ICSPA3] -BD4HB1L-A- <input type="checkbox"/> - <input type="checkbox"/> - <input type="checkbox"/> -B-T1- <input type="checkbox"/> - <input type="checkbox"/>
Incremental	1	H	ICSA3 [ICSPA3] -BD1HB1H-I- <input type="checkbox"/> - <input type="checkbox"/> - <input type="checkbox"/> -B-T1- <input type="checkbox"/> - <input type="checkbox"/>
		M	ICSA3 [ICSPA3] -BD1HB1M-I- <input type="checkbox"/> - <input type="checkbox"/> - <input type="checkbox"/> -B-T1- <input type="checkbox"/> - <input type="checkbox"/>
		L	ICSA3 [ICSPA3] -BD1HB1L-I- <input type="checkbox"/> - <input type="checkbox"/> - <input type="checkbox"/> -B-T1- <input type="checkbox"/> - <input type="checkbox"/>
	2	H	ICSA3 [ICSPA3] -BD2HB1H-I- <input type="checkbox"/> - <input type="checkbox"/> - <input type="checkbox"/> -B-T1- <input type="checkbox"/> - <input type="checkbox"/>
		M	ICSA3 [ICSPA3] -BD2HB1M-I- <input type="checkbox"/> - <input type="checkbox"/> - <input type="checkbox"/> -B-T1- <input type="checkbox"/> - <input type="checkbox"/>
		L	ICSA3 [ICSPA3] -BD2HB1L-I- <input type="checkbox"/> - <input type="checkbox"/> - <input type="checkbox"/> -B-T1- <input type="checkbox"/> - <input type="checkbox"/>
	3	H	ICSA3 [ICSPA3] -BD3HB1H-I- <input type="checkbox"/> - <input type="checkbox"/> - <input type="checkbox"/> -B-T1- <input type="checkbox"/> - <input type="checkbox"/>
		M	ICSA3 [ICSPA3] -BD3HB1M-I- <input type="checkbox"/> - <input type="checkbox"/> - <input type="checkbox"/> -B-T1- <input type="checkbox"/> - <input type="checkbox"/>
		L	ICSA3 [ICSPA3] -BD3HB1L-I- <input type="checkbox"/> - <input type="checkbox"/> - <input type="checkbox"/> -B-T1- <input type="checkbox"/> - <input type="checkbox"/>
	4	H	ICSA3 [ICSPA3] -BD4HB1H-I- <input type="checkbox"/> - <input type="checkbox"/> - <input type="checkbox"/> -B-T1- <input type="checkbox"/> - <input type="checkbox"/>
		M	ICSA3 [ICSPA3] -BD4HB1M-I- <input type="checkbox"/> - <input type="checkbox"/> - <input type="checkbox"/> -B-T1- <input type="checkbox"/> - <input type="checkbox"/>
		L	ICSA3 [ICSPA3] -BD4HB1L-I- <input type="checkbox"/> - <input type="checkbox"/> - <input type="checkbox"/> -B-T1- <input type="checkbox"/> - <input type="checkbox"/>

*1: Refer to the figure below for XY-axis configuration direction.
*2: The load capacity and the maximum speed may vary depending on the type of Z-axis.
Note: T1 in the above models will be T2 when operated with XSEL-P/Q type.

Explanation of Model Code

Number	Contents	Specification
<input type="checkbox"/>	X-axis stroke (Note 1)	80 : 800mm ~ 200 : 2000mm
<input type="checkbox"/>	Y-axis stroke (Note 1)	10 : 100mm ~ 50 : 500mm
<input type="checkbox"/>	Z-axis stroke (Note 1)	10 : 100mm ~ 40 : 400mm
<input type="checkbox"/>	Cable length (Note 2)	3L : 3m 5L : 5m
<input type="checkbox"/>	Y-axis/ Z-axis cable management	CT-SC : Self-standing cable (*3) CT-CT : Cable track

* The above explains the Models/Specifications chart to the left.
*3 Only cable track can be specified for the Y-axis cable management with model # BD□HB1□.

Options

Please add the option codes at the end of each stroke of the axis.
When adding multiple options, put together in alphabetic order.

Name	Code	Page
AQ seal	AQ	P13
Brake	B	P13
Creep sensor	C	P13
Home limit switch	L	P14
Reversed-home specification	NM	P14
Guide with ball-retaining mechanism	RT	P14

Configuration Direction

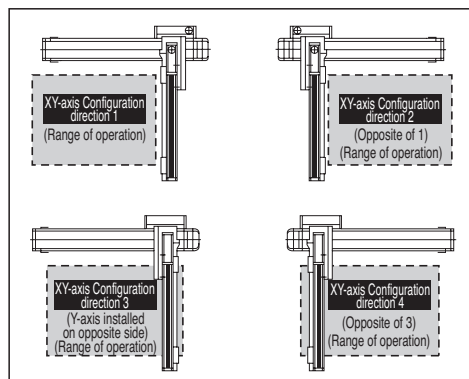

Common Specifications

* [] is for the high-precision specification.

Drive system	Ball screw, rolled C10 [equivalent to rolled C5]
Positioning repeatability	±0.02mm [±0.01mm]
Backlash	0.05mm or less [0.02mm or less]
Guide	Integrated with base
Base	Material: Aluminum with white alumite treatment
X-axis motor output / lead	200W / 20mm
Y-axis motor output / lead	100W / 20mm
Z-axis motor output / lead	60W / 16mm (H), 8mm (M), 4mm (L)

Applicable Controller Specifications

Refer to page 65 for System Configuration.

Axis Configuration

* [] is for the high-precision specification.

Axis Type	Model	Page
X-axis	ISA[ISPA]-MXM□-200-20-(Stroke)-T1	P20
Y-axis	ISA[ISPA]-MYM□-100-20-(Stroke)-T1	P21
Z-axis	ISA[ISPA]-SXM□-60-16/8/4-(Stroke)-T1-B	P15

* In the above model name, □ indicates encoder type A (absolute) or I (incremental).



Caution

(Note 1) The stroke in the model is specified in cm (centimeters).
(Note 2) The cable length measures from the X-axis connector box to the controller. The standard lengths are 3m and 5m, but other lengths can also be specified in meters. The maximum length is 20m.
(Note 3) The rated acceleration is 0.3G. Increasing the acceleration will result in lower load capacity.
(Note 4) Please note that a longer stroke will result in a lower maximum speed.

* For other points to note, please refer to page 49.

ICSA3 [ICSPA3] -BD□HB1□

Load Capacity (kg) (Note3)

BD□HB1H

		Y-axis stroke				
		100	200	300	400	500
Z-axis stroke	100	3.0				
	200	3.0				
	300	3.0				
	400	3.0				

BD□HB1M

		Y-axis stroke				
		100	200	300	400	500
Z-axis stroke	100	6.0				
	200	6.0				
	300	6.0				
	400	6.0				

BD□HB1L

		Y-axis stroke				
		100	200	300	400	500
Z-axis stroke	100	14.0				13.5
	200	14.0				12.9
	300	14.0				12.3
	300	13.5				11.7

Maximum Speed by Stroke (mm/sec) (Note4)

BD□HB1H

	Stroke									
	100 ~ 400	500	800 ~ 1300	1400	1500	1600	1700	1800	1900	2000
X-axis	-	-	1000	950	800	700	600	550	500	450
Y-axis	1000		-	-	-	-	-	-	-	-
Z-axis	800	-	-	-	-	-	-	-	-	-

BD□HB1M

	Stroke									
	100 ~ 400	500	800 ~ 1300	1400	1500	1600	1700	1800	1900	2000
X-axis	-	-	1000	950	800	700	600	550	500	450
Y-axis	1000		-	-	-	-	-	-	-	-
Z-axis	400	-	-	-	-	-	-	-	-	-

BD□HB1L

	Stroke									
	100 ~ 400	500	800 ~ 1300	1400	1500	1600	1700	1800	1900	2000
X-axis	-	-	1000	950	800	700	600	550	500	450
Y-axis	1000		-	-	-	-	-	-	-	-
Z-axis	200	-	-	-	-	-	-	-	-	-

Dimensions

* The dimension below is for XY-axis Configuration direction 1.

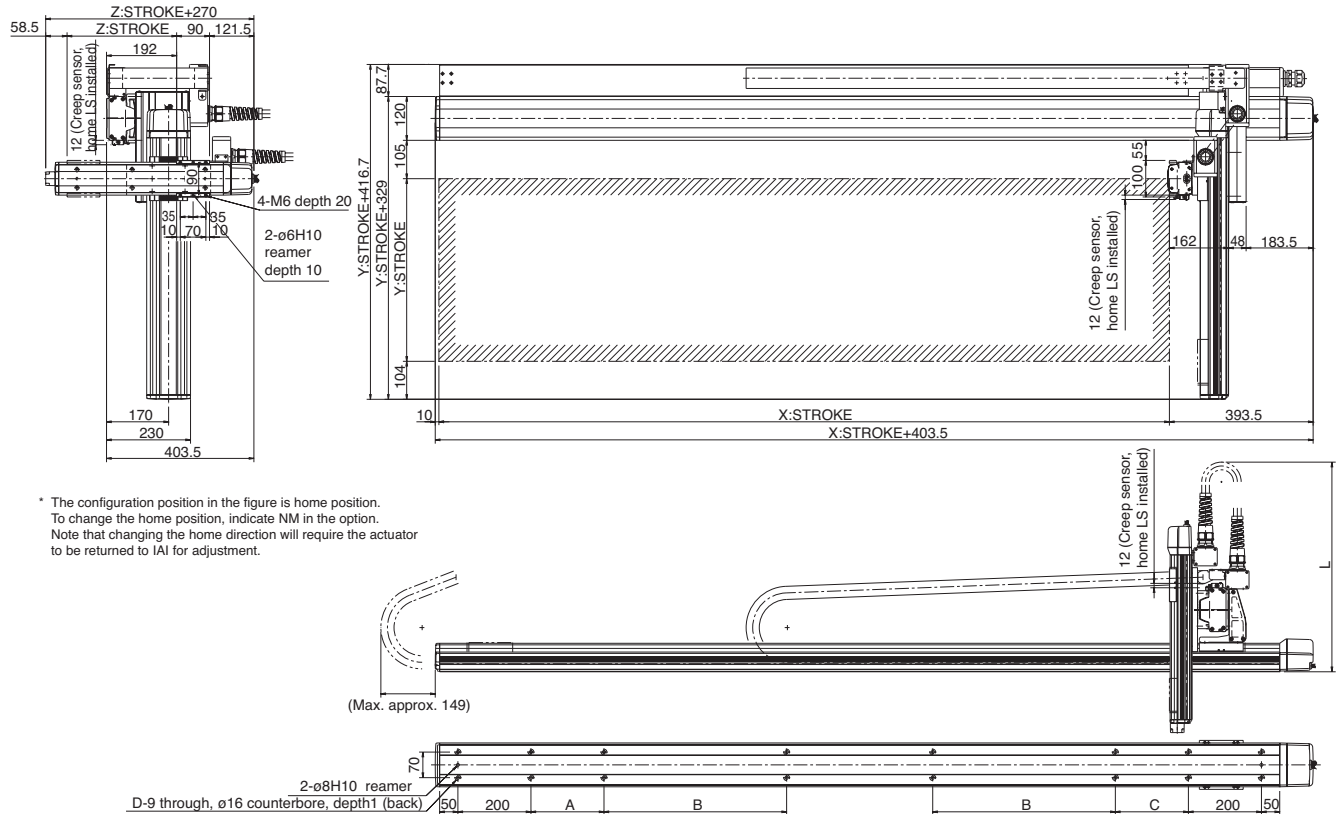

* The configuration position in the figure is home position. To change the home position, indicate NM in the option. Note that changing the home direction will require the actuator to be returned to IAI for adjustment.

X st	800	900	1000	1100	1200	1300	1400	1500	1600	1700	1800	1900	2000
A	0	0	200	250	300	350	400	450	500	550	200	200	200
B	0	0	0	0	0	0	0	0	0	0	400	450	500
C	200	200	200	250	300	350	400	450	500	550	200	200	200
D	10	10	12	12	12	12	12	12	12	12	16	16	16

Y st	100	200	300	400	500
L	(590)	(640)	(690)	(740)	(790)

ICSA3-BD **HB2**

Cartesian Robot: X-Y-Z 3-Axes Configuration
Z-axis Base Mount Type

ICSPA3-BD **HB2**

Cartesian Robot: X-Y-Z 3-Axes Configuration
Z-axis Base Mount Type **High-Precision Specification**

Type XYB + Z-axis Base Mount Type

Stroke X-axis: 800-2000mm Y-axis: 100-500mm Z-axis: 100-400mm

Load capacity 10.7kg ~ 3.5kg

Model specification items Series Type Encoder type X-axis stroke + options Y-axis stroke + options Z-axis stroke + options Applicable controller Cable length Cable management
(Example) ICSA3 (ICSPA3) - BD1HB2M - A - 100AQL - 40AQL - 30BL - T1 - 5L - CT - SC

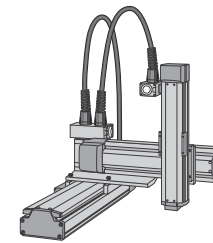

* Refer to page 51 for the details of model specification items.

Models/Specifications

* [] is for the high-precision specification.

Encoder Type	XY-axis configuration direction (*1)	Z-axis type (*2)	Model
Absolute	1	H	ICSA3 [ICSPA3] -BD1HB2H-A- <input type="checkbox"/> - <input type="checkbox"/> - <input type="checkbox"/> -B-T1- <input type="checkbox"/> - <input type="checkbox"/>
		M	ICSA3 [ICSPA3] -BD1HB2M-A- <input type="checkbox"/> - <input type="checkbox"/> - <input type="checkbox"/> -B-T1- <input type="checkbox"/> - <input type="checkbox"/>
		L	ICSA3 [ICSPA3] -BD1HB2L-A- <input type="checkbox"/> - <input type="checkbox"/> - <input type="checkbox"/> -B-T1- <input type="checkbox"/> - <input type="checkbox"/>
	2	H	ICSA3 [ICSPA3] -BD2HB2H-A- <input type="checkbox"/> - <input type="checkbox"/> - <input type="checkbox"/> -B-T1- <input type="checkbox"/> - <input type="checkbox"/>
		M	ICSA3 [ICSPA3] -BD2HB2M-A- <input type="checkbox"/> - <input type="checkbox"/> - <input type="checkbox"/> -B-T1- <input type="checkbox"/> - <input type="checkbox"/>
		L	ICSA3 [ICSPA3] -BD2HB2L-A- <input type="checkbox"/> - <input type="checkbox"/> - <input type="checkbox"/> -B-T1- <input type="checkbox"/> - <input type="checkbox"/>
	3	H	ICSA3 [ICSPA3] -BD3HB2H-A- <input type="checkbox"/> - <input type="checkbox"/> - <input type="checkbox"/> -B-T1- <input type="checkbox"/> - <input type="checkbox"/>
		M	ICSA3 [ICSPA3] -BD3HB2M-A- <input type="checkbox"/> - <input type="checkbox"/> - <input type="checkbox"/> -B-T1- <input type="checkbox"/> - <input type="checkbox"/>
		L	ICSA3 [ICSPA3] -BD3HB2L-A- <input type="checkbox"/> - <input type="checkbox"/> - <input type="checkbox"/> -B-T1- <input type="checkbox"/> - <input type="checkbox"/>
	4	H	ICSA3 [ICSPA3] -BD4HB2H-A- <input type="checkbox"/> - <input type="checkbox"/> - <input type="checkbox"/> -B-T1- <input type="checkbox"/> - <input type="checkbox"/>
		M	ICSA3 [ICSPA3] -BD4HB2M-A- <input type="checkbox"/> - <input type="checkbox"/> - <input type="checkbox"/> -B-T1- <input type="checkbox"/> - <input type="checkbox"/>
		L	ICSA3 [ICSPA3] -BD4HB2L-A- <input type="checkbox"/> - <input type="checkbox"/> - <input type="checkbox"/> -B-T1- <input type="checkbox"/> - <input type="checkbox"/>
Incremental	1	H	ICSA3 [ICSPA3] -BD1HB2H-I- <input type="checkbox"/> - <input type="checkbox"/> - <input type="checkbox"/> -B-T1- <input type="checkbox"/> - <input type="checkbox"/>
		M	ICSA3 [ICSPA3] -BD1HB2M-I- <input type="checkbox"/> - <input type="checkbox"/> - <input type="checkbox"/> -B-T1- <input type="checkbox"/> - <input type="checkbox"/>
		L	ICSA3 [ICSPA3] -BD1HB2L-I- <input type="checkbox"/> - <input type="checkbox"/> - <input type="checkbox"/> -B-T1- <input type="checkbox"/> - <input type="checkbox"/>
	2	H	ICSA3 [ICSPA3] -BD2HB2H-I- <input type="checkbox"/> - <input type="checkbox"/> - <input type="checkbox"/> -B-T1- <input type="checkbox"/> - <input type="checkbox"/>
		M	ICSA3 [ICSPA3] -BD2HB2M-I- <input type="checkbox"/> - <input type="checkbox"/> - <input type="checkbox"/> -B-T1- <input type="checkbox"/> - <input type="checkbox"/>
		L	ICSA3 [ICSPA3] -BD2HB2L-I- <input type="checkbox"/> - <input type="checkbox"/> - <input type="checkbox"/> -B-T1- <input type="checkbox"/> - <input type="checkbox"/>
	3	H	ICSA3 [ICSPA3] -BD3HB2H-I- <input type="checkbox"/> - <input type="checkbox"/> - <input type="checkbox"/> -B-T1- <input type="checkbox"/> - <input type="checkbox"/>
		M	ICSA3 [ICSPA3] -BD3HB2M-I- <input type="checkbox"/> - <input type="checkbox"/> - <input type="checkbox"/> -B-T1- <input type="checkbox"/> - <input type="checkbox"/>
		L	ICSA3 [ICSPA3] -BD3HB2L-I- <input type="checkbox"/> - <input type="checkbox"/> - <input type="checkbox"/> -B-T1- <input type="checkbox"/> - <input type="checkbox"/>
	4	H	ICSA3 [ICSPA3] -BD4HB2H-I- <input type="checkbox"/> - <input type="checkbox"/> - <input type="checkbox"/> -B-T1- <input type="checkbox"/> - <input type="checkbox"/>
		M	ICSA3 [ICSPA3] -BD4HB2M-I- <input type="checkbox"/> - <input type="checkbox"/> - <input type="checkbox"/> -B-T1- <input type="checkbox"/> - <input type="checkbox"/>
		L	ICSA3 [ICSPA3] -BD4HB2L-I- <input type="checkbox"/> - <input type="checkbox"/> - <input type="checkbox"/> -B-T1- <input type="checkbox"/> - <input type="checkbox"/>

*1: Refer to the figure below for XY-axis configuration direction.

*2: The load capacity and the maximum speed may vary depending on the type of Z-axis.

Note: T1 in the above models will be T2 when operated with XSEL-P/Q type.

Explanation of Model Code

Number	Contents	Specification
①	X-axis stroke (Note 1)	80 : 800mm ~ 200 : 2000mm
②	Y-axis stroke (Note 1)	10 : 100mm ~ 50 : 500mm
③	Z-axis stroke (Note 1)	10 : 100mm ~ 40 : 400mm
④	Cable length (Note 2)	3L : 3m 5L : 5m
⑤	Y-axis/ Z-axis cable management	CT-SC : Self-standing cable (*3) CT-CT : Cable track

* The above explains the Models/Specifications chart to the left.

*3 Only cable track can be specified for the Y-axis cable management with model # BD□HB2□.

Options

Please add the option codes at the end of each stroke of the axis. When adding multiple options, put together in alphabetic order.

Name	Code	Page
AQ seal	AQ	P13
Brake	B	P13
Creep sensor	C	P13
Home limit switch	L	P14
Reversed-home specification	NM	P14
Guide with ball-retaining mechanism	RT	P14

Configuration Direction

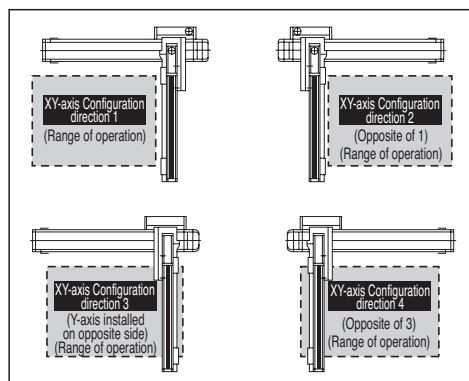

Common Specifications

* [] is for the high-precision specification.

Drive system	Ball screw, rolled C10 [equivalent to rolled C5]
Positioning repeatability	±0.02mm [±0.01mm]
Backlash	0.05mm or less [0.02mm or less]
Guide	Integrated with base
Base	Material: Aluminum with white alumite treatment
X-axis motor output / lead	200W / 20mm
Y-axis motor output / lead	100W / 20mm
Z-axis motor output / lead	100W / 20mm (H), 10mm (M), 5mm (L)

Applicable Controller Specifications

Refer to page 65 for System Configuration.

Axis Configuration

* [] is for the high-precision specification.

Axis Type	Model	Page
X-axis	ISA[ISPA]-MXMX-□-200-20-(Stroke)-T1	P20
Y-axis	ISA[ISPA]-MYM-□-100-20-(Stroke)-T1	P21
Z-axis	ISA[ISPA]-MXM-□-100-20/10/5-(Stroke)-T1-B	P18

*In the above model name, □ indicates encoder type A (absolute) or I (incremental).



Caution

(Note 1) The stroke in the model is specified in cm (centimeters).

(Note 2) The cable length measures from the X-axis connector box to the controller. The standard lengths are 3m and 5m, but other lengths can also be specified in meters. The maximum length is 20m.

(Note 3) The rated acceleration is 0.3G. Increasing the acceleration will result in lower load capacity.

(Note 4) Please note that a longer stroke will result in a lower maximum speed.

* For other points to note, please refer to page 49.

ICSA3 [ICSPA3] -BD□HB2□

Load Capacity (kg) (Note3)

■BD□HB2H

		Y-axis stroke				
		100	200	300	400	500
Z-axis stroke	100	3.5				
	200	3.5				
	300	3.5				
	400	3.5				

■BD□HB2M

		Y-axis stroke				
		100	200	300	400	500
Z-axis stroke	100	9.0				
	200	9.0			8.4	
	300	8.6			7.3	
	400	7.6			6.3	

■BD□HB2L

		Y-axis stroke				
		100	200	300	400	500
Z-axis stroke	100	10.7			9.4	
	200	9.7			8.4	
	300	8.6			7.3	
	300	7.6			6.3	

Maximum Speed by Stroke (mm/sec) (Note4)

■BD□HB2H

	Stroke									
	100 ~ 400	500	800 ~ 1300	1400	1500	1600	1700	1800	1900	2000
X-axis	-	-	1000	950	800	700	600	550	500	450
Y-axis	1000		-	-	-	-	-	-	-	-
Z-axis	1000	-	-	-	-	-	-	-	-	-

■BD□HB2M

	Stroke									
	100 ~ 400	500	800 ~ 1300	1400	1500	1600	1700	1800	1900	2000
X-axis	-	-	1000	950	800	700	600	550	500	450
Y-axis	1000		-	-	-	-	-	-	-	-
Z-axis	500	-	-	-	-	-	-	-	-	-

■BD□HB2L

	Stroke									
	100 ~ 400	500	800 ~ 1300	1400	1500	1600	1700	1800	1900	2000
X-axis	-	-	1000	950	800	700	600	550	500	450
Y-axis	1000		-	-	-	-	-	-	-	-
Z-axis	250	-	-	-	-	-	-	-	-	-

Dimensions * The dimension below is for XY-axis Configuration direction 1.

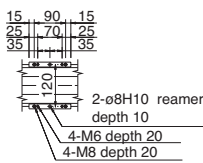
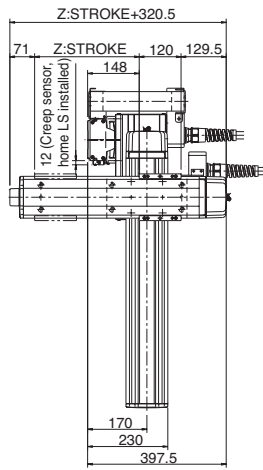

Detail View of Z-Axis slider

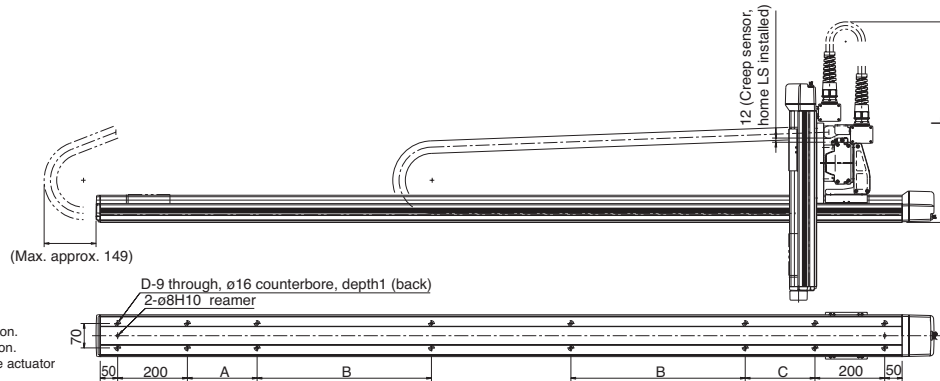
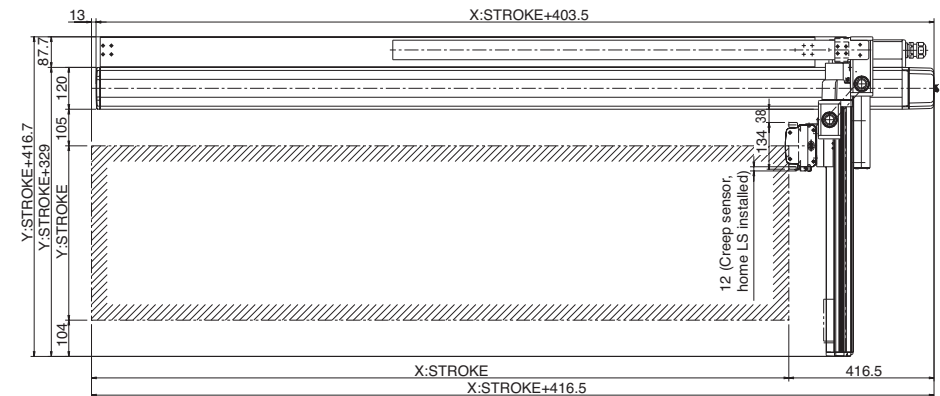

* The configuration position in the figure is home position. To change the home position, indicate NM in the option. Note that changing the home direction will require the actuator to be returned to IAI for adjustment.

X st	800	900	1000	1100	1200	1300	1400	1500	1600	1700	1800	1900	2000
A	0	0	200	250	300	350	400	450	500	550	200	200	200
B	0	0	0	0	0	0	0	0	0	0	400	450	500
C	200	200	200	250	300	350	400	450	500	550	200	200	200
D	10	10	12	12	12	12	12	12	12	12	16	16	16

Y st	100	200	300	400	500
L	(590)	(640)	(690)	(740)	(790)

ICSA3-BD **HB3**

Cartesian Robot: X-Y-Z 3-Axes Configuration
Z-axis Base Mount Type

ICSPA3-BD **HB3**

Cartesian Robot: X-Y-Z 3-Axes Configuration
Z-axis Base Mount Type **High-Precision Specification**

Type XYB + Z-axis Base Mount Type Stroke X-axis: 800~2000mm Y-axis: 100~500mm Z-axis: 100~400mm Load capacity 10.7kg ~ 6.3kg

Model specification items Series - Type - Encoder type - X-axis stroke + options - Y-axis stroke + options - Z-axis stroke + options - Applicable controller - Cable length - Cable management
(Example) ICSA3 [ICSPA3] - BD1HB3M - A - 100AQL - 40AQL - 30BL - T1 - 5L - CT - SC

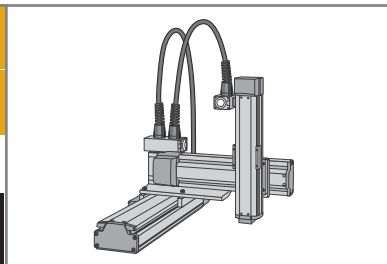

* Refer to page 51 for the details of model specification items.

Models/Specifications * [] is for the high-precision specification.

Encoder Type	XY-axis configuration direction (*1)	Z-axis type (*2)	Model
Absolute	1	H	ICSA3 [ICSPA3] -BD1HB3H-A- <input type="checkbox"/> - <input type="checkbox"/> - <input type="checkbox"/> -B-T1- <input type="checkbox"/> - <input type="checkbox"/>
		M	ICSA3 [ICSPA3] -BD1HB3M-A- <input type="checkbox"/> - <input type="checkbox"/> - <input type="checkbox"/> -B-T1- <input type="checkbox"/> - <input type="checkbox"/>
	2	H	ICSA3 [ICSPA3] -BD2HB3H-A- <input type="checkbox"/> - <input type="checkbox"/> - <input type="checkbox"/> -B-T1- <input type="checkbox"/> - <input type="checkbox"/>
		M	ICSA3 [ICSPA3] -BD2HB3M-A- <input type="checkbox"/> - <input type="checkbox"/> - <input type="checkbox"/> -B-T1- <input type="checkbox"/> - <input type="checkbox"/>
	3	H	ICSA3 [ICSPA3] -BD3HB3H-A- <input type="checkbox"/> - <input type="checkbox"/> - <input type="checkbox"/> -B-T1- <input type="checkbox"/> - <input type="checkbox"/>
		M	ICSA3 [ICSPA3] -BD3HB3M-A- <input type="checkbox"/> - <input type="checkbox"/> - <input type="checkbox"/> -B-T1- <input type="checkbox"/> - <input type="checkbox"/>
	4	H	ICSA3 [ICSPA3] -BD4HB3H-A- <input type="checkbox"/> - <input type="checkbox"/> - <input type="checkbox"/> -B-T1- <input type="checkbox"/> - <input type="checkbox"/>
		M	ICSA3 [ICSPA3] -BD4HB3M-A- <input type="checkbox"/> - <input type="checkbox"/> - <input type="checkbox"/> -B-T1- <input type="checkbox"/> - <input type="checkbox"/>
Incremental	1	H	ICSA3 [ICSPA3] -BD1HB3H-I- <input type="checkbox"/> - <input type="checkbox"/> - <input type="checkbox"/> -B-T1- <input type="checkbox"/> - <input type="checkbox"/>
		M	ICSA3 [ICSPA3] -BD1HB3M-I- <input type="checkbox"/> - <input type="checkbox"/> - <input type="checkbox"/> -B-T1- <input type="checkbox"/> - <input type="checkbox"/>
	2	H	ICSA3 [ICSPA3] -BD2HB3H-I- <input type="checkbox"/> - <input type="checkbox"/> - <input type="checkbox"/> -B-T1- <input type="checkbox"/> - <input type="checkbox"/>
		M	ICSA3 [ICSPA3] -BD2HB3M-I- <input type="checkbox"/> - <input type="checkbox"/> - <input type="checkbox"/> -B-T1- <input type="checkbox"/> - <input type="checkbox"/>
	3	H	ICSA3 [ICSPA3] -BD3HB3H-I- <input type="checkbox"/> - <input type="checkbox"/> - <input type="checkbox"/> -B-T1- <input type="checkbox"/> - <input type="checkbox"/>
		M	ICSA3 [ICSPA3] -BD3HB3M-I- <input type="checkbox"/> - <input type="checkbox"/> - <input type="checkbox"/> -B-T1- <input type="checkbox"/> - <input type="checkbox"/>
	4	H	ICSA3 [ICSPA3] -BD4HB3H-I- <input type="checkbox"/> - <input type="checkbox"/> - <input type="checkbox"/> -B-T1- <input type="checkbox"/> - <input type="checkbox"/>
		M	ICSA3 [ICSPA3] -BD4HB3M-I- <input type="checkbox"/> - <input type="checkbox"/> - <input type="checkbox"/> -B-T1- <input type="checkbox"/> - <input type="checkbox"/>

*1: Refer to the figure below for XY-axis configuration direction.

*2: The load capacity and the maximum speed may vary depending on the type of Z-axis. Note: T1 in the above models will be T2 when operated with XSEL-P/Q type.

Explanation of Model Code

Number	Contents	Specification
<input type="checkbox"/>	X-axis stroke (Note 1)	80 : 800mm ~ 200 : 2000mm
<input type="checkbox"/>	Y-axis stroke (Note 1)	10 : 100mm ~ 50 : 500mm
<input type="checkbox"/>	Z-axis stroke (Note 1)	10 : 100mm ~ 40 : 400mm
<input type="checkbox"/>	Cable length (Note 2)	3L : 3m 5L : 5m
<input type="checkbox"/>	Y-axis/ Z-axis cable management	CT-SC : Self-standing cable (*3) CT-CT : Cable track

* The above explains the Models/Specifications chart to the left.

*3 Only cable track can be specified for the Y-axis cable management with model # BD□HB3□.

Options

Please add the option codes at the end of each stroke of the axis. When adding multiple options, put together in alphabetic order.

Name	Code	Page
AQ seal	AQ	P13
Brake	B	P13
Creep sensor	C	P13
Home limit switch	L	P14
Reversed-home specification	NM	P14
Guide with ball-retaining mechanism	RT	P14

Configuration Direction

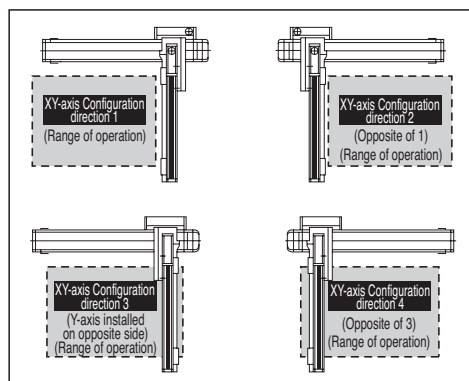

Axis Configuration * [] is for the high-precision specification.

Axis Type	Model	Page
X-axis	ISA[ISPA]-MXMX-□-200-20-(Stroke)-T1	P20
Y-axis	ISA[ISPA]-MYM-□-100-20-(Stroke)-T1	P21
Z-axis	ISA[ISPA]-MXM-□-200-20/10-(Stroke)-T1-B	P19

* In the above model name, □ indicates encoder type A (absolute) or I (incremental).

Common Specifications * [] is for the high-precision specification.

Drive system	Ball screw, rolled C10 [equivalent to rolled C5]
Positioning repeatability	±0.02mm [±0.01mm]
Backlash	0.05mm or less [0.02mm or less]
Guide	Integrated with base
Base	Material: Aluminum with white alumite treatment
X-axis motor output / lead	200W / 20mm
Y-axis motor output / lead	100W / 20mm
Z-axis motor output / lead	200W / 20mm (H), 10mm (M)

Applicable Controller Specifications

Refer to page 65 for System Configuration.



Caution

(Note 1) The stroke in the model is specified in cm (centimeters).

(Note 2) The cable length measures from the X-axis connector box to the controller. The standard lengths are 3m and 5m, but other lengths can also be specified in meters. The maximum length is 20m.

(Note 3) The rated acceleration is 0.3G. Increasing the acceleration will result in lower load capacity.

(Note 4) Please note that a longer stroke will result in a lower maximum speed.

* For other points to note, please refer to page 49.

ICSA3 [ICSPA3] -BD□HB3□

Load Capacity (kg) (Note3)

BD□HB3H

		Y-axis stroke				
		100	200	300	400	500
Z-axis stroke	100	9.0				
	200	9.0			8.4	
	300	8.6			7.3	
	400	7.6			6.3	

BD□HB3M

		Y-axis stroke				
		100	200	300	400	500
Z-axis stroke	100	10.7			9.4	
	200	9.7			8.4	
	300	8.6			7.3	
	400	7.6			6.3	

Maximum Speed by Stroke (mm/sec) (Note4)

BD□HB3H

	Stroke									
	100 ~ 400	500	800 ~ 1300	1400	1500	1600	1700	1800	1900	2000
X-axis	-	-	1000	950	800	700	600	550	500	450
Y-axis	1000		-	-	-	-	-	-	-	-
Z-axis	1000	-	-	-	-	-	-	-	-	-

BD□HB3M

	Stroke									
	100 ~ 400	500	800 ~ 1300	1400	1500	1600	1700	1800	1900	2000
X-axis	-	-	1000	950	800	700	600	550	500	450
Y-axis	1000		-	-	-	-	-	-	-	-
Z-axis	500	-	-	-	-	-	-	-	-	-

Dimensions

* The dimension below is for XY-axis Configuration direction 1.

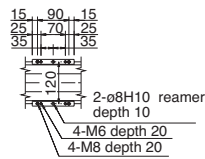
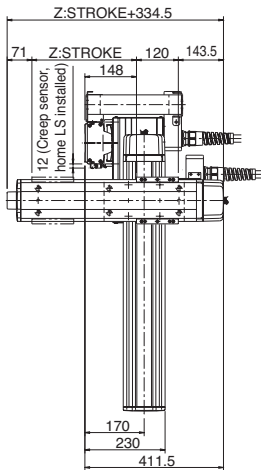

Detail View of Z-Axis slider

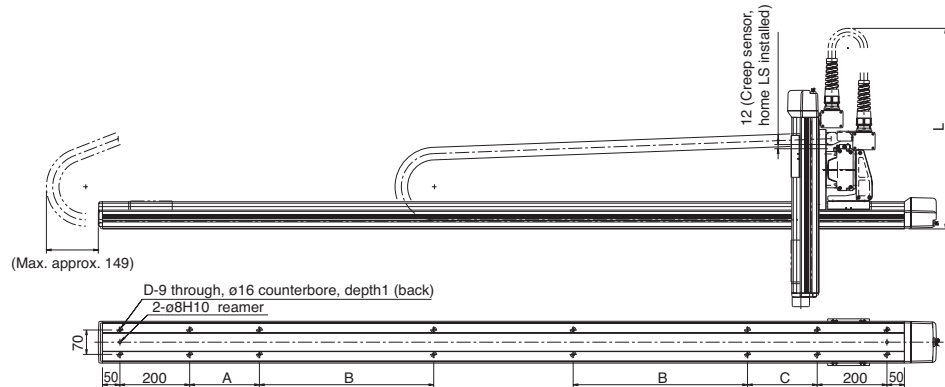
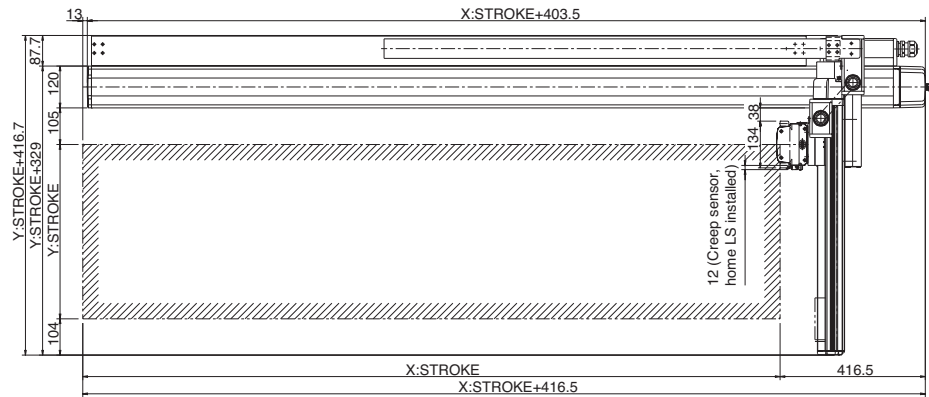

* The configuration position in the figure is home position. To change the home position, indicate NM in the option. Note that changing the home direction will require the actuator to be returned to IAI for adjustment.

X st	800	900	1000	1100	1200	1300	1400	1500	1600	1700	1800	1900	2000
A	0	0	200	250	300	350	400	450	500	550	200	200	200
B	0	0	0	0	0	0	0	0	0	0	400	450	500
C	200	200	200	250	300	350	400	450	500	550	200	200	200
D	10	10	12	12	12	12	12	12	12	12	16	16	16

Y st	100	200	300	400	500
L	(590)	(640)	(690)	(740)	(790)

ICSA3-BE **HB1**

Cartesian Robot: X-Y-Z 3-Axes Configuration
Z-axis Base Mount Type

ICSPA3-BE **HB1**

Cartesian Robot: X-Y-Z 3-Axes Configuration
Z-axis Base Mount Type **High-Precision Specification**

Type XYB + Z-axis Base Mount Type Stroke X-axis: 300~1000mm Y-axis: 200~700mm Z-axis: 100~500mm Load capacity 14kg ~ 3kg

Model specification items Series Type Encoder type X-axis stroke + options Y-axis stroke + options Z-axis stroke + options Applicable controller Cable length Cable management
(Example) ICSA3 (ICSPA3) - BE1HB1M - A - 70AQL - 40AQL - 30BL - T1 - 5L - SC-SC

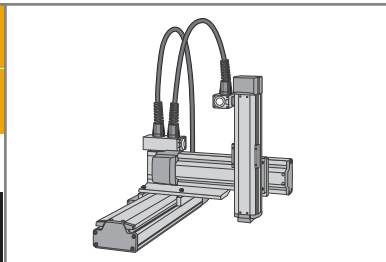

* Refer to page 51 for the details of model specification items.

Models/Specifications * [] is for the high-precision specification.

Encoder Type	XY-axis configuration direction (*1)	Z-axis type (*2)	Model
Absolute	1	H	ICSA3 [ICSPA3] -BE1HB1H-A- [1]- [2]- [3]-B-T1- [4]- [5]
		M	ICSA3 [ICSPA3] -BE1HB1M-A- [1]- [2]- [3]-B-T1- [4]- [5]
		L	ICSA3 [ICSPA3] -BE1HB1L-A- [1]- [2]- [3]-B-T1- [4]- [5]
	2	H	ICSA3 [ICSPA3] -BE2HB1H-A- [1]- [2]- [3]-B-T1- [4]- [5]
		M	ICSA3 [ICSPA3] -BE2HB1M-A- [1]- [2]- [3]-B-T1- [4]- [5]
		L	ICSA3 [ICSPA3] -BE2HB1L-A- [1]- [2]- [3]-B-T1- [4]- [5]
	3	H	ICSA3 [ICSPA3] -BE3HB1H-A- [1]- [2]- [3]-B-T1- [4]- [5]
		M	ICSA3 [ICSPA3] -BE3HB1M-A- [1]- [2]- [3]-B-T1- [4]- [5]
		L	ICSA3 [ICSPA3] -BE3HB1L-A- [1]- [2]- [3]-B-T1- [4]- [5]
	4	H	ICSA3 [ICSPA3] -BE4HB1H-A- [1]- [2]- [3]-B-T1- [4]- [5]
		M	ICSA3 [ICSPA3] -BE4HB1M-A- [1]- [2]- [3]-B-T1- [4]- [5]
		L	ICSA3 [ICSPA3] -BE4HB1L-A- [1]- [2]- [3]-B-T1- [4]- [5]
Incremental	1	H	ICSA3 [ICSPA3] -BE1HB1H-I- [1]- [2]- [3]-B-T1- [4]- [5]
		M	ICSA3 [ICSPA3] -BE1HB1M-I- [1]- [2]- [3]-B-T1- [4]- [5]
		L	ICSA3 [ICSPA3] -BE1HB1L-I- [1]- [2]- [3]-B-T1- [4]- [5]
	2	H	ICSA3 [ICSPA3] -BE2HB1H-I- [1]- [2]- [3]-B-T1- [4]- [5]
		M	ICSA3 [ICSPA3] -BE2HB1M-I- [1]- [2]- [3]-B-T1- [4]- [5]
		L	ICSA3 [ICSPA3] -BE2HB1L-I- [1]- [2]- [3]-B-T1- [4]- [5]
	3	H	ICSA3 [ICSPA3] -BE3HB1H-I- [1]- [2]- [3]-B-T1- [4]- [5]
		M	ICSA3 [ICSPA3] -BE3HB1M-I- [1]- [2]- [3]-B-T1- [4]- [5]
		L	ICSA3 [ICSPA3] -BE3HB1L-I- [1]- [2]- [3]-B-T1- [4]- [5]
	4	H	ICSA3 [ICSPA3] -BE4HB1H-I- [1]- [2]- [3]-B-T1- [4]- [5]
		M	ICSA3 [ICSPA3] -BE4HB1M-I- [1]- [2]- [3]-B-T1- [4]- [5]
		L	ICSA3 [ICSPA3] -BE4HB1L-I- [1]- [2]- [3]-B-T1- [4]- [5]

*1: Refer to the figure below for XY-axis configuration direction.
*2: The load capacity and the maximum speed may vary depending on the type of Z-axis.
Note: T1 in the above models will be T2 when operated with XSEL-P/Q type.

Explanation of Model Code

Number	Contents	Specification
①	X-axis stroke (Note 1)	30 : 300mm ~ 100 : 1000mm
②	Y-axis stroke (Note 1)	20 : 200mm ~ 70 : 700mm
③	Z-axis stroke (Note 1)	10 : 100mm ~ 50 : 500mm
④	Cable length (Note 2)	3L : 3m 5L : 5m
⑤	Y-axis/ Z-axis cable management	SC-SC : Self-standing cable CT-CT : Cable track

* The above explains the Models/Specifications chart to the left.

Options

Please add the option codes at the end of each stroke of the axis. When adding multiple options, put together in alphabetic order.

Name	Code	Page
AQ seal	AQ	P13
Brake	B	P13
Creep sensor	C	P13
Home limit switch	L	P14
Reversed-home specification	NM	P14
Guide with ball-retaining mechanism	RT	P14

Configuration Direction

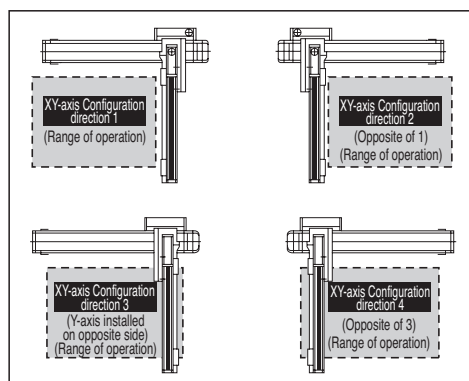

Common Specifications * [] is for the high-precision specification.

Drive system	Ball screw, rolled C10 [equivalent to rolled C5]
Positioning repeatability	±0.02mm [±0.01mm]
Backlash	0.05mm or less [0.02mm or less]
Guide	Integrated with base
Base	Material: Aluminum with white alumite treatment
X-axis motor output / lead	400W / 20mm
Y-axis motor output / lead	200W / 20mm
Z-axis motor output / lead	60W / 16mm (H), 8mm (M), 4mm (L)

Applicable Controller Specifications

Refer to page 65 for System Configuration.

Axis Configuration * [] is for the high-precision specification.

Axis Type	Model	Page
X-axis	ISA[ISPA]-LXM-□-400-20-(Stroke)-T1	P26
Y-axis	ISA[ISPA]-MYM-□-200-20-(Stroke)-T1	P22
Z-axis	ISA[ISPA]-SXM-□-60-16/8/4-(Stroke)-T1-B	P15

* In the above model name, □ indicates encoder type A (absolute) or I (incremental).



Caution

(Note 1) The stroke in the model is specified in cm (centimeters).
(Note 2) The cable length measures from the X-axis connector box to the controller. The standard lengths are 3m and 5m, but other lengths can also be specified in meters. The maximum length is 20m.
(Note 3) The rated acceleration is 0.3G. Increasing the acceleration will result in lower load capacity.
(Note 4) Please note that a longer stroke will result in a lower maximum speed.

* For other points to note, please refer to page 49.

ICSA3 [ICSPA3] -BE□HB1□

Load Capacity (kg) (Note3)

BE□HB1H

		Y-axis stroke					
		200	300	400	500	600	700
Z-axis stroke	100	3.0					
	200	3.0					
	300	3.0					
	400	3.0					
	500	3.0					

BE□HB1M

		Y-axis stroke					
		200	300	400	500	600	700
Z-axis stroke	100	6.0					
	200	6.0					
	300	6.0					
	400	6.0					
	500	6.0					

BE□HB1L

		Y-axis stroke					
		200	300	400	500	600	700
Z-axis stroke	100	14.0					
	200	14.0					13.5
	300	14.0					12.9
	400	14.0					12.3
	500	14.0					11.7
	600	14.0					

Maximum Speed by Stroke (mm/sec) (Note4)

BE□HB1H

	Stroke											
	100	200	300	400	500	600	700	800	900	1000		
X-axis	-	-	1000						830	690		
Y-axis	-	1000								-	-	-
Z-axis	800			-	-	-	-	-	-	-		

BE□HB1M

	Stroke											
	100	200	300	400	500	600	700	800	900	1000		
X-axis	-	-	1000						830	690		
Y-axis	-	1000								-	-	-
Z-axis	400			-	-	-	-	-	-	-		

BE□HB1L

	Stroke											
	100	200	300	400	500	600	700	800	900	1000		
X-axis	-	-	1000						830	690		
Y-axis	-	1000								-	-	-
Z-axis	200			-	-	-	-	-	-	-		

Dimensions * The dimension below is for XY-axis Configuration direction 1.

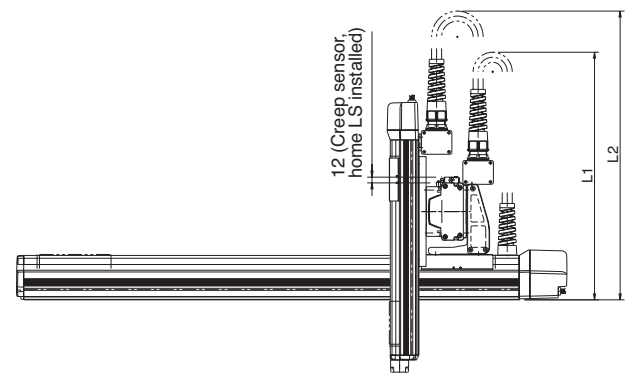
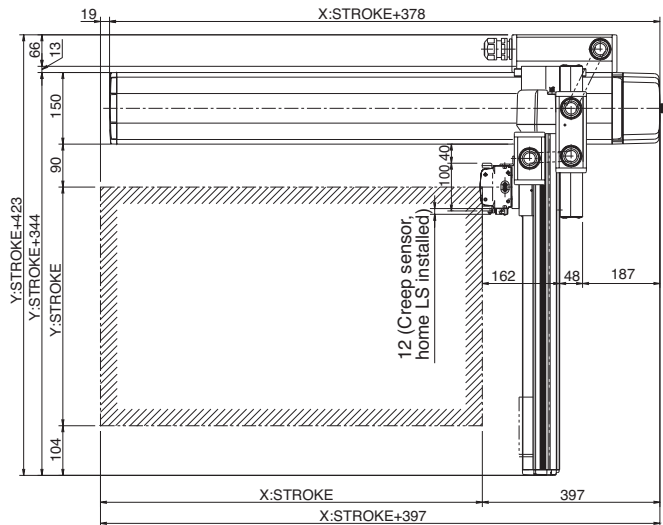
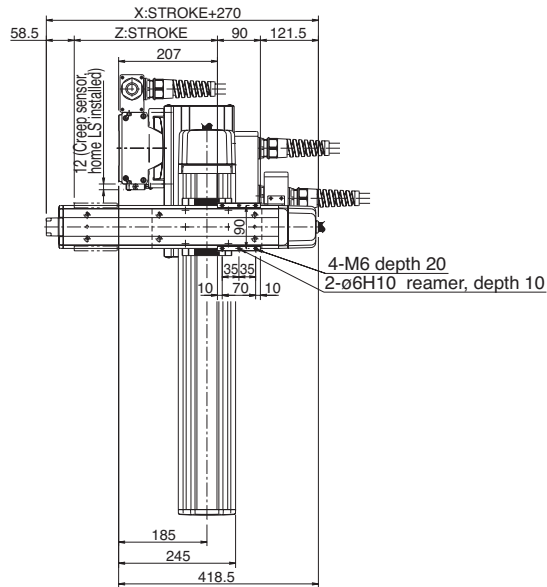

* The configuration position in the figure is home position. To change the home position, indicate NM in the option. Note that changing the home direction will require the actuator to be returned to IAI for adjustment.

2-ø8H10 reamer C-9 through, ø16 counterbore, depth1 (back)

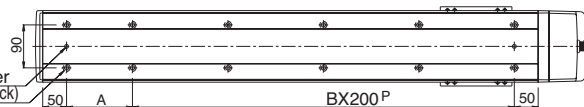

X stroke	300	400	500	600	700	800	900	1000
L1	(600)	(650)	(700)	(750)	(800)	(850)	(900)	(950)
A	238	138	238	138	238	138	238	138
B	1	2	2	3	3	4	4	5
C	6	8	8	10	10	12	12	14

Y stroke	200	300	400	500	600	700
L2	(690)	(740)	(790)	(840)	(890)	(940)

ICSA3-BE **HB2**

Cartesian Robot: X-Y-Z 3-Axes Configuration
Z-Axis Base Mount Type

ICSPA3-BE **HB2**

Cartesian Robot: X-Y-Z 3-Axes Configuration
Z-Axis Base Mount Type **High-Precision Specification**

Type XYB + Z-Axis Base Mount Type Stroke X-axis: 300~1000mm Y-axis: 200~700mm Z-axis: 100~500mm Load capacity 19kg ~ 3.5kg

Model specification items Series Type Encoder type X-axis stroke + options Y-axis stroke + options Z-axis stroke + options Applicable controller Cable length Cable management
(Example) ICSA3 (ICSPA3) - BE1HB2M - A - 70AQL - 40AQL - 30BL - T1 - 5L - SC - SC

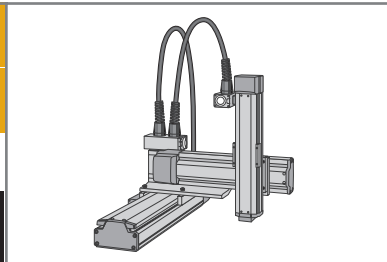

* Refer to page 51 for the details of model specification items.

Models/Specifications * [] is for the high-precision specification.

Encoder Type	XY-axis configuration direction (*1)	Z-axis type (*2)	Model
Absolute	1	H	ICSA3 [ICSPA3] -BE1HB2H-A- [0] - [2] - [3] -B-T1- [4] - [6]
		M	ICSA3 [ICSPA3] -BE1HB2M-A- [0] - [2] - [3] -B-T1- [4] - [6]
		L	ICSA3 [ICSPA3] -BE1HB2L-A- [0] - [2] - [3] -B-T1- [4] - [6]
	2	H	ICSA3 [ICSPA3] -BE2HB2H-A- [0] - [2] - [3] -B-T1- [4] - [6]
		M	ICSA3 [ICSPA3] -BE2HB2M-A- [0] - [2] - [3] -B-T1- [4] - [6]
		L	ICSA3 [ICSPA3] -BE2HB2L-A- [0] - [2] - [3] -B-T1- [4] - [6]
	3	H	ICSA3 [ICSPA3] -BE3HB2H-A- [0] - [2] - [3] -B-T1- [4] - [6]
		M	ICSA3 [ICSPA3] -BE3HB2M-A- [0] - [2] - [3] -B-T1- [4] - [6]
		L	ICSA3 [ICSPA3] -BE3HB2L-A- [0] - [2] - [3] -B-T1- [4] - [6]
	4	H	ICSA3 [ICSPA3] -BE4HB2H-A- [0] - [2] - [3] -B-T1- [4] - [6]
		M	ICSA3 [ICSPA3] -BE4HB2M-A- [0] - [2] - [3] -B-T1- [4] - [6]
		L	ICSA3 [ICSPA3] -BE4HB2L-A- [0] - [2] - [3] -B-T1- [4] - [6]
Incremental	1	H	ICSA3 [ICSPA3] -BE1HB2H-I- [0] - [2] - [3] -B-T1- [4] - [6]
		M	ICSA3 [ICSPA3] -BE1HB2M-I- [0] - [2] - [3] -B-T1- [4] - [6]
		L	ICSA3 [ICSPA3] -BE1HB2L-I- [0] - [2] - [3] -B-T1- [4] - [6]
	2	H	ICSA3 [ICSPA3] -BE2HB2H-I- [0] - [2] - [3] -B-T1- [4] - [6]
		M	ICSA3 [ICSPA3] -BE2HB2M-I- [0] - [2] - [3] -B-T1- [4] - [6]
		L	ICSA3 [ICSPA3] -BE2HB2L-I- [0] - [2] - [3] -B-T1- [4] - [6]
	3	H	ICSA3 [ICSPA3] -BE3HB2H-I- [0] - [2] - [3] -B-T1- [4] - [6]
		M	ICSA3 [ICSPA3] -BE3HB2M-I- [0] - [2] - [3] -B-T1- [4] - [6]
		L	ICSA3 [ICSPA3] -BE3HB2L-I- [0] - [2] - [3] -B-T1- [4] - [6]
	4	H	ICSA3 [ICSPA3] -BE4HB2H-I- [0] - [2] - [3] -B-T1- [4] - [6]
		M	ICSA3 [ICSPA3] -BE4HB2M-I- [0] - [2] - [3] -B-T1- [4] - [6]
		L	ICSA3 [ICSPA3] -BE4HB2L-I- [0] - [2] - [3] -B-T1- [4] - [6]

*1: Refer to the figure below for XY-axis configuration direction.
*2: The load capacity and the maximum speed may vary depending on the type of Z-axis.
Note: T1 in the above models will be T2 when operated with XSEL-P/Q type.

Explanation of Model Code

Number	Contents	Specification
①	X-axis stroke (Note 1)	30 : 300mm ~ 100 : 1000mm
②	Y-axis stroke (Note 1)	20 : 200mm ~ 70 : 700mm
③	Z-axis stroke (Note 1)	10 : 100mm ~ 50 : 500mm
④	Cable length (Note 2)	3L : 3m 5L : 5m
⑤	Y-axis/ Z-axis cable management	SC-SC : Self-standing cable CT-CT : Cable track

* The above explains the Models/Specifications chart to the left.

Options

Please add the option codes at the end of each stroke of the axis.
When adding multiple options, put together in alphabetic order.

Name	Code	Page
AQ seal	AQ	P13
Brake	B	P13
Creep sensor	C	P13
Home limit switch	L	P14
Reversed-home specification	NM	P14
Guide with ball-retaining mechanism	RT	P14

Configuration Direction

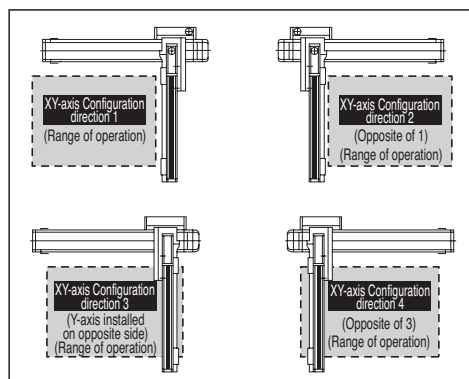

Common Specifications * [] is for the high-precision specification.

Drive system	Ball screw, rolled C10 [equivalent to rolled C5]
Positioning repeatability	±0.02mm [±0.01mm]
Backlash	0.05mm or less [0.02mm or less]
Guide	Integrated with base
Base	Material: Aluminum with white alumite treatment
X-axis motor output / lead	400W / 20mm
Y-axis motor output / lead	200W / 20mm
Z-axis motor output / lead	100W / 20mm (H), 10mm (M), 5mm (L)

Applicable Controller Specifications

Refer to page 65 for System Configuration.

Axis Configuration * [] is for the high-precision specification.

Axis Type	Model	Page
X-axis	ISA[ISPA]-LXM-□-400-20-(Stroke)-T1	P26
Y-axis	ISA[ISPA]-MYM-□-200-20-(Stroke)-T1	P22
Z-axis	ISA[ISPA]-MXM-□-100-20/10/5-(Stroke)-T1-B	P18

* In the above model name, □ indicates encoder type A (absolute) or I (incremental).



Caution

(Note 1) The stroke in the model is specified in cm (centimeters).
(Note 2) The cable length measures from the X-axis connector box to the controller. The standard lengths are 3m and 5m, but other lengths can also be specified in meters. The maximum length is 20m.
(Note 3) The rated acceleration is 0.3G. Increasing the acceleration will result in lower load capacity.
(Note 4) Please note that a longer stroke will result in a lower maximum speed.

* For other points to note, please refer to page 49.

ICSA3 [ICSPA3] -BE□HB2□

Load Capacity (kg) (Note3)

BE□HB2H

		Y-axis stroke					
		200	300	400	500	600	700
Z-axis stroke	100	3.5					
	200	3.5					
	300	3.5					
	400	3.5					
	500	3.5					

BE□HB2M

		Y-axis stroke					
		200	300	400	500	600	700
Z-axis stroke	100	9.0					
	200	9.0					
	300	9.0				7.9	
	400	9.0				6.9	
	500	9.0				5.8	

BE□HB2L

		Y-axis stroke					
		200	300	400	500	600	700
Z-axis stroke	100	19.0	18.0	13.6	10.0		
	200	19.0	17.0	12.6	9.0		
	300	19.0	15.9	11.5	7.9		
	400	19.0	14.9	10.5	6.9		
	500	19.0	13.8	9.4	5.8		

Maximum Speed by Stroke (mm/sec) (Note4)

BE□HB2H

		Stroke									
		100	200	300	400	500	600	700	800	900	1000
X-axis	-	-	1000						830	690	
Y-axis	-	1000						-	-	-	-
Z-axis	1000		-	-	-	-	-	-	-	-	

BE□HB2M

		Stroke									
		100	200	300	400	500	600	700	800	900	1000
X-axis	-	-	1000						830	690	
Y-axis	-	1000						-	-	-	-
Z-axis	500		-	-	-	-	-	-	-	-	

BE□HB2L

		Stroke									
		100	200	300	400	500	600	700	800	900	1000
X-axis	-	-	1000						830	690	
Y-axis	-	1000						-	-	-	-
Z-axis	250		-	-	-	-	-	-	-	-	

Dimensions * The dimension below is for XY-axis Configuration direction 1.

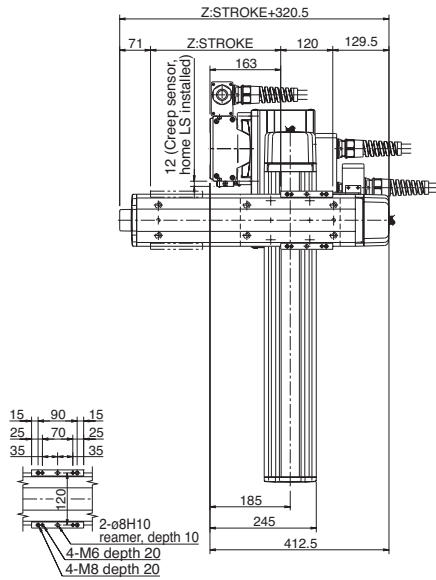

Detail View of Z-Axis slider

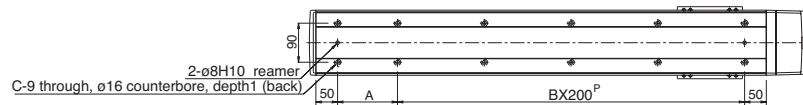
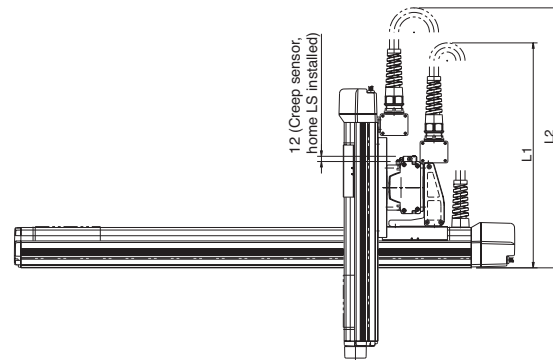
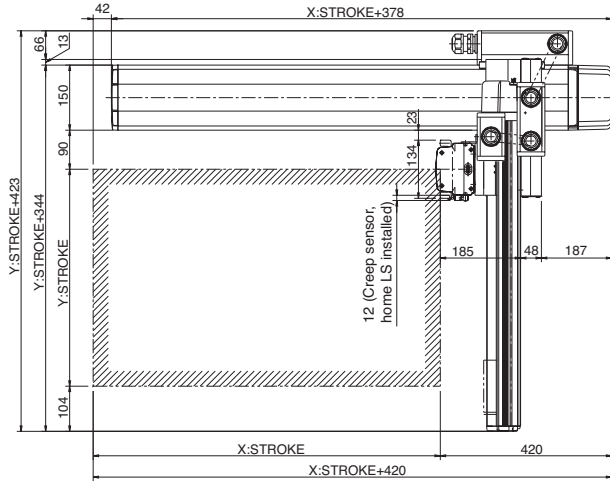

* The configuration position in the figure is home position. To change the home position, indicate NM in the option. Note that changing the home direction will require the actuator to be returned to IAI for adjustment.

X stroke	300	400	500	600	700	800	900	1000
L1	(600)	(650)	(700)	(750)	(800)	(850)	(900)	(950)
A	238	138	238	138	238	138	238	138
B	1	2	2	3	3	4	4	5
C	6	8	8	10	10	12	12	14

Y stroke	200	300	400	500	600	700
L2	(690)	(740)	(790)	(840)	(890)	(940)

ICSA3-BE **HB3**

Cartesian Robot: X-Y-Z 3-Axes Configuration
Z-axis Base Mount Type

ICSPA3-BE **HB3**

Cartesian Robot: X-Y-Z 3-Axes Configuration
Z-axis Base Mount Type **High-Precision Specification**

Type XYB + Z-axis Base Mount Type **Stroke** X-axis: 300~1000mm Y-axis: 200~700mm Z-axis: 100~500mm **Load capacity** 19kg ~ 5.8kg

Model specification items Series - Type - Encoder type - X-axis stroke + options - Y-axis stroke + options - Z-axis stroke + options - Applicable controller - Cable length - Cable management
(Example) ICSA3 (ICSPA3) - BE1HB3M - A - 70AQL - 40AQL - 30BL - T1 - 5L - SC - SC

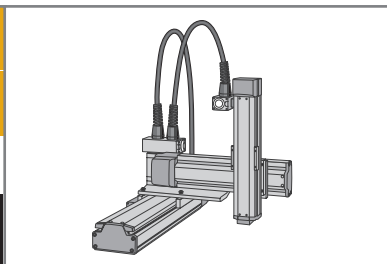

* Refer to page 51 for the details of model specification items.

Models/Specifications * [] is for the high-precision specification.

Encoder Type	XY-axis configuration direction (*1)	Z-axis type (*2)	Model
Absolute	1	H	ICSA3 [ICSPA3] -BE1HB3H-A- <input type="checkbox"/> - <input type="checkbox"/> - <input type="checkbox"/> -B-T1- <input type="checkbox"/> - <input type="checkbox"/>
		M	ICSA3 [ICSPA3] -BE1HB3M-A- <input type="checkbox"/> - <input type="checkbox"/> - <input type="checkbox"/> -B-T1- <input type="checkbox"/> - <input type="checkbox"/>
	2	H	ICSA3 [ICSPA3] -BE2HB3H-A- <input type="checkbox"/> - <input type="checkbox"/> - <input type="checkbox"/> -B-T1- <input type="checkbox"/> - <input type="checkbox"/>
		M	ICSA3 [ICSPA3] -BE2HB3M-A- <input type="checkbox"/> - <input type="checkbox"/> - <input type="checkbox"/> -B-T1- <input type="checkbox"/> - <input type="checkbox"/>
	3	H	ICSA3 [ICSPA3] -BE3HB3H-A- <input type="checkbox"/> - <input type="checkbox"/> - <input type="checkbox"/> -B-T1- <input type="checkbox"/> - <input type="checkbox"/>
		M	ICSA3 [ICSPA3] -BE3HB3M-A- <input type="checkbox"/> - <input type="checkbox"/> - <input type="checkbox"/> -B-T1- <input type="checkbox"/> - <input type="checkbox"/>
	4	H	ICSA3 [ICSPA3] -BE4HB3H-A- <input type="checkbox"/> - <input type="checkbox"/> - <input type="checkbox"/> -B-T1- <input type="checkbox"/> - <input type="checkbox"/>
		M	ICSA3 [ICSPA3] -BE4HB3M-A- <input type="checkbox"/> - <input type="checkbox"/> - <input type="checkbox"/> -B-T1- <input type="checkbox"/> - <input type="checkbox"/>
Incremental	1	H	ICSA3 [ICSPA3] -BE1HB3H-I- <input type="checkbox"/> - <input type="checkbox"/> - <input type="checkbox"/> -B-T1- <input type="checkbox"/> - <input type="checkbox"/>
		M	ICSA3 [ICSPA3] -BE1HB3M-I- <input type="checkbox"/> - <input type="checkbox"/> - <input type="checkbox"/> -B-T1- <input type="checkbox"/> - <input type="checkbox"/>
	2	H	ICSA3 [ICSPA3] -BE2HB3H-I- <input type="checkbox"/> - <input type="checkbox"/> - <input type="checkbox"/> -B-T1- <input type="checkbox"/> - <input type="checkbox"/>
		M	ICSA3 [ICSPA3] -BE2HB3M-I- <input type="checkbox"/> - <input type="checkbox"/> - <input type="checkbox"/> -B-T1- <input type="checkbox"/> - <input type="checkbox"/>
	3	H	ICSA3 [ICSPA3] -BE3HB3H-I- <input type="checkbox"/> - <input type="checkbox"/> - <input type="checkbox"/> -B-T1- <input type="checkbox"/> - <input type="checkbox"/>
		M	ICSA3 [ICSPA3] -BE3HB3M-I- <input type="checkbox"/> - <input type="checkbox"/> - <input type="checkbox"/> -B-T1- <input type="checkbox"/> - <input type="checkbox"/>
	4	H	ICSA3 [ICSPA3] -BE4HB3H-I- <input type="checkbox"/> - <input type="checkbox"/> - <input type="checkbox"/> -B-T1- <input type="checkbox"/> - <input type="checkbox"/>
		M	ICSA3 [ICSPA3] -BE4HB3M-I- <input type="checkbox"/> - <input type="checkbox"/> - <input type="checkbox"/> -B-T1- <input type="checkbox"/> - <input type="checkbox"/>

*1: Refer to the figure below for XY-axis configuration direction.
*2: The load capacity and the maximum speed may vary depending on the type of Z-axis.
Note: T1 in the above models will be T2 when operated with XSEL-P/Q type.

Explanation of Model Code

Number	Contents	Specification
<input type="checkbox"/>	X-axis stroke (Note 1)	30 : 300mm ~ 100 : 1000mm
<input type="checkbox"/>	Y-axis stroke (Note 1)	20 : 200mm ~ 70 : 700mm
<input type="checkbox"/>	Z-axis stroke (Note 1)	10 : 100mm ~ 50 : 500mm
<input type="checkbox"/>	Cable length (Note 2)	3L : 3m 5L : 5m
<input type="checkbox"/>	Y-axis/ Z-axis cable management	SC-SC : Self-standing cable CT-CT : Cable track

* The above explains the Models/Specifications chart to the left.

Options

Please add the option codes at the end of each stroke of the axis.
When adding multiple options, put together in alphabetic order.

Name	Code	Page
AQ seal	AQ	P13
Brake	B	P13
Creep sensor	C	P13
Home limit switch	L	P14
Reversed-home specification	NM	P14
Guide with ball-retaining mechanism	RT	P14

Configuration Direction

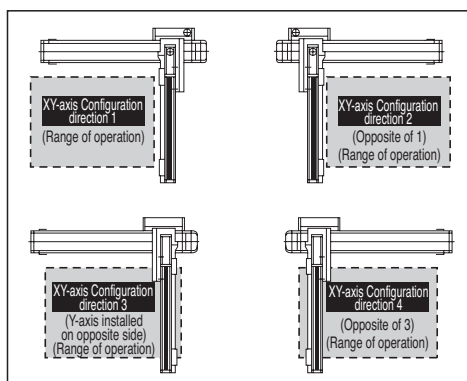

Common Specifications * [] is for the high-precision specification.

Drive system	Ball screw, rolled C10 [equivalent to rolled C5]
Positioning repeatability	±0.02mm [±0.01mm]
Backlash	0.05mm or less [0.02mm or less]
Guide	Integrated with base
Base	Material: Aluminum with white alumite treatment
X-axis motor output / lead	400W / 20mm
Y-axis motor output / lead	200W / 20mm
Z-axis motor output / lead	200W / 20mm (H), 10mm (M)

Applicable Controller Specifications

Refer to page 65 for System Configuration.

Axis Configuration * [] is for the high-precision specification.

Axis Type	Model	Page
X-axis	ISA[ISPA]-LXM- <input type="checkbox"/> -400-20-(Stroke)-T1	P26
Y-axis	ISA[ISPA]-MYM- <input type="checkbox"/> -200-20-(Stroke)-T1	P22
Z-axis	ISA[ISPA]-MXM- <input type="checkbox"/> -200-20/10-(Stroke)-T1-B	P19

*In the above model name, indicates encoder type A (absolute) or I (incremental).



Caution

(Note 1) The stroke in the model is specified in cm (centimeters).
(Note 2) The cable length measures from the X-axis connector box to the controller. The standard lengths are 3m and 5m, but other lengths can also be specified in meters. The maximum length is 20m.
(Note 3) The rated acceleration is 0.3G. Increasing the acceleration will result in lower load capacity.
(Note 4) Please note that a longer stroke will result in a lower maximum speed.

* For other points to note, please refer to page 49.

ICSA3 [ICSPA3] -BE□HB3□

Load Capacity (kg) (Note3)

BE□HB3H

		Y-axis stroke					
		200	300	400	500	600	700
Z-axis stroke	100	9.0					
	200	9.0					
	300	9.0				7.9	
	400	9.0				6.9	
	500	9.0				5.8	

BE□HB3M

		Y-axis stroke					
		200	300	400	500	600	700
Z-axis stroke	100	19.0	18.0	13.6	10.0		
	200	19.0	17.0	12.6	9.0		
	300	19.0	15.9	11.5	7.9		
	400	19.0	14.9	10.5	6.9		
	500	19.0	13.8	9.4	5.8		

Maximum Speed by Stroke (mm/sec) (Note4)

BE□HB3H

	Stroke										
	100	200	300	400	500	600	700	800	900	1000	
X-axis	-	-	1000					830	690		
Y-axis	-	1000					-	-			
Z-axis	1000		-	-	-	-	-				

BE□HB3M

	Stroke										
	100	200	300	400	500	600	700	800	900	1000	
X-axis	-	-	1000					830	690		
Y-axis	-	1000					-	-			
Z-axis	500		-	-	-	-	-				

Dimensions

* The dimension below is for XY-axis Configuration direction 1.

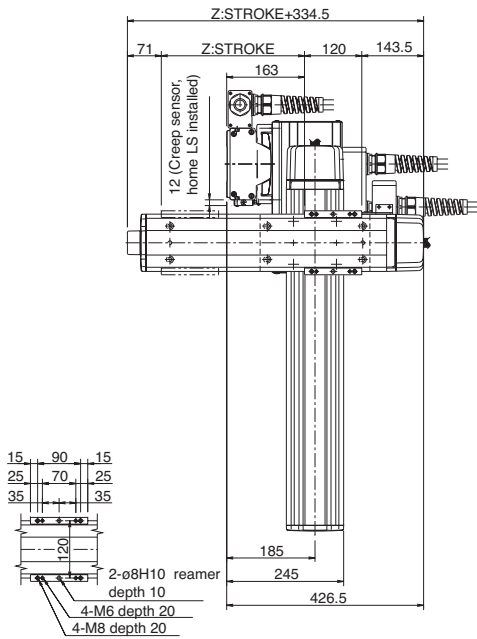

Detail View of Z-Axis slider

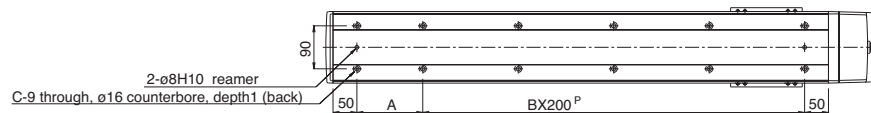
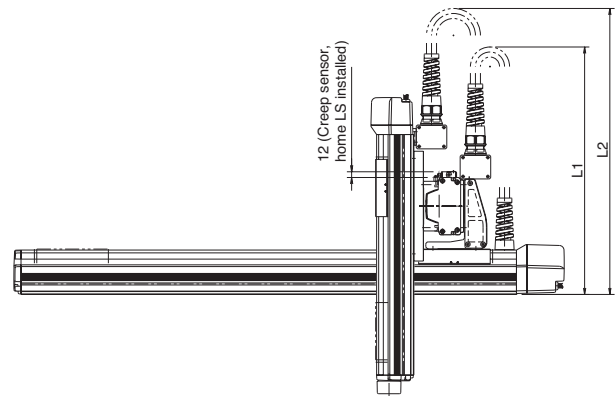
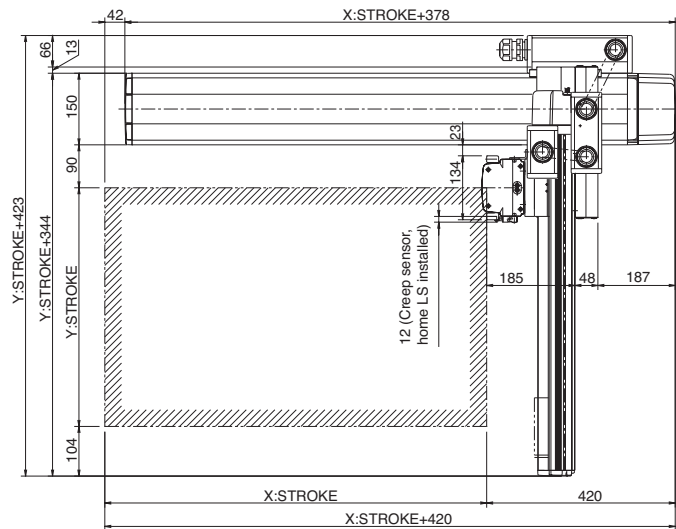

* The configuration position in the figure is home position. To change the home position, indicate NM in the option. Note that changing the home direction will require the actuator to be returned to IA1 for adjustment.

X stroke	300	400	500	600	700	800	900	1000
L1	(600)	(650)	(700)	(750)	(800)	(850)	(900)	(950)
A	238	138	238	138	238	138	238	138
B	1	2	2	3	3	4	4	5
C	6	8	8	10	10	12	12	14

Y stroke	200	300	400	500	600	700
L2	(690)	(740)	(790)	(840)	(890)	(940)

ICSA3-BE **MB2**

Cartesian Robot: X-Y-Z 3-Axes Configuration
Z-axis Base Mount Type

ICSPA3-BE **MB2**

Cartesian Robot: X-Y-Z 3-Axes Configuration
Z-axis Base Mount Type **High-Precision Specification**

Type XYB + Z-axis Base Mount Type Stroke X-axis: 300~1000mm Y-axis: 200~700mm Z-axis: 100~500mm Load capacity 19kg ~ 3.5kg

Model specification items Series - Type - Encoder type - X-axis stroke + options - Y-axis stroke + options - Z-axis stroke + options - Applicable controller - Cable length - Cable management
(Example) ICSA3 (ICSPA3) - BE1MB2M - A - 70AQL - 40AQL - 30BL - T1 - 5L - SC-SC

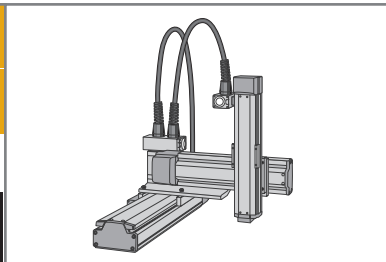

* Refer to page 51 for the details of model specification items.

Models/Specifications * [] is for the high-precision specification.

Encoder Type	XY-axis configuration direction (*1)	Z-axis type (*2)	Model
Absolute	1	H	ICSA3 [ICSPA3] -BE1MB2H-A- <input type="checkbox"/> - <input type="checkbox"/> - <input type="checkbox"/> -B-T1- <input type="checkbox"/> - <input type="checkbox"/>
		M	ICSA3 [ICSPA3] -BE1MB2M-A- <input type="checkbox"/> - <input type="checkbox"/> - <input type="checkbox"/> -B-T1- <input type="checkbox"/> - <input type="checkbox"/>
		L	ICSA3 [ICSPA3] -BE1MB2L-A- <input type="checkbox"/> - <input type="checkbox"/> - <input type="checkbox"/> -B-T1- <input type="checkbox"/> - <input type="checkbox"/>
	2	H	ICSA3 [ICSPA3] -BE2MB2H-A- <input type="checkbox"/> - <input type="checkbox"/> - <input type="checkbox"/> -B-T1- <input type="checkbox"/> - <input type="checkbox"/>
		M	ICSA3 [ICSPA3] -BE2MB2M-A- <input type="checkbox"/> - <input type="checkbox"/> - <input type="checkbox"/> -B-T1- <input type="checkbox"/> - <input type="checkbox"/>
		L	ICSA3 [ICSPA3] -BE2MB2L-A- <input type="checkbox"/> - <input type="checkbox"/> - <input type="checkbox"/> -B-T1- <input type="checkbox"/> - <input type="checkbox"/>
	3	H	ICSA3 [ICSPA3] -BE3MB2H-A- <input type="checkbox"/> - <input type="checkbox"/> - <input type="checkbox"/> -B-T1- <input type="checkbox"/> - <input type="checkbox"/>
		M	ICSA3 [ICSPA3] -BE3MB2M-A- <input type="checkbox"/> - <input type="checkbox"/> - <input type="checkbox"/> -B-T1- <input type="checkbox"/> - <input type="checkbox"/>
		L	ICSA3 [ICSPA3] -BE3MB2L-A- <input type="checkbox"/> - <input type="checkbox"/> - <input type="checkbox"/> -B-T1- <input type="checkbox"/> - <input type="checkbox"/>
	4	H	ICSA3 [ICSPA3] -BE4MB2H-A- <input type="checkbox"/> - <input type="checkbox"/> - <input type="checkbox"/> -B-T1- <input type="checkbox"/> - <input type="checkbox"/>
		M	ICSA3 [ICSPA3] -BE4MB2M-A- <input type="checkbox"/> - <input type="checkbox"/> - <input type="checkbox"/> -B-T1- <input type="checkbox"/> - <input type="checkbox"/>
		L	ICSA3 [ICSPA3] -BE4MB2L-A- <input type="checkbox"/> - <input type="checkbox"/> - <input type="checkbox"/> -B-T1- <input type="checkbox"/> - <input type="checkbox"/>
Incremental	1	H	ICSA3 [ICSPA3] -BE1MB2H-I- <input type="checkbox"/> - <input type="checkbox"/> - <input type="checkbox"/> -B-T1- <input type="checkbox"/> - <input type="checkbox"/>
		M	ICSA3 [ICSPA3] -BE1MB2M-I- <input type="checkbox"/> - <input type="checkbox"/> - <input type="checkbox"/> -B-T1- <input type="checkbox"/> - <input type="checkbox"/>
		L	ICSA3 [ICSPA3] -BE1MB2L-I- <input type="checkbox"/> - <input type="checkbox"/> - <input type="checkbox"/> -B-T1- <input type="checkbox"/> - <input type="checkbox"/>
	2	H	ICSA3 [ICSPA3] -BE2MB2H-I- <input type="checkbox"/> - <input type="checkbox"/> - <input type="checkbox"/> -B-T1- <input type="checkbox"/> - <input type="checkbox"/>
		M	ICSA3 [ICSPA3] -BE2MB2M-I- <input type="checkbox"/> - <input type="checkbox"/> - <input type="checkbox"/> -B-T1- <input type="checkbox"/> - <input type="checkbox"/>
		L	ICSA3 [ICSPA3] -BE2MB2L-I- <input type="checkbox"/> - <input type="checkbox"/> - <input type="checkbox"/> -B-T1- <input type="checkbox"/> - <input type="checkbox"/>
	3	H	ICSA3 [ICSPA3] -BE3MB2H-I- <input type="checkbox"/> - <input type="checkbox"/> - <input type="checkbox"/> -B-T1- <input type="checkbox"/> - <input type="checkbox"/>
		M	ICSA3 [ICSPA3] -BE3MB2M-I- <input type="checkbox"/> - <input type="checkbox"/> - <input type="checkbox"/> -B-T1- <input type="checkbox"/> - <input type="checkbox"/>
		L	ICSA3 [ICSPA3] -BE3MB2L-I- <input type="checkbox"/> - <input type="checkbox"/> - <input type="checkbox"/> -B-T1- <input type="checkbox"/> - <input type="checkbox"/>
	4	H	ICSA3 [ICSPA3] -BE4MB2H-I- <input type="checkbox"/> - <input type="checkbox"/> - <input type="checkbox"/> -B-T1- <input type="checkbox"/> - <input type="checkbox"/>
		M	ICSA3 [ICSPA3] -BE4MB2M-I- <input type="checkbox"/> - <input type="checkbox"/> - <input type="checkbox"/> -B-T1- <input type="checkbox"/> - <input type="checkbox"/>
		L	ICSA3 [ICSPA3] -BE4MB2L-I- <input type="checkbox"/> - <input type="checkbox"/> - <input type="checkbox"/> -B-T1- <input type="checkbox"/> - <input type="checkbox"/>

*1: Refer to the figure below for XY-axis configuration direction.
*2: The load capacity and the maximum speed may vary depending on the type of Z-axis.
Note: T1 in the above models will be T2 when operated with XSEL-P/Q type.

Explanation of Model Code

Number	Contents	Specification
①	X-axis stroke (Note 1)	30 : 300mm ~ 100 : 1000mm
②	Y-axis stroke (Note 1)	20 : 200mm ~ 70 : 700mm
③	Z-axis stroke (Note 1)	10 : 100mm ~ 50 : 500mm
④	Cable length (Note 2)	3L : 3m 5L : 5m
⑤	Y-axis/ Z-axis cable management	SC-SC : Self-standing cable CT-CT : Cable track

* The above explains the Models/Specifications chart to the left.

Options

Please add the option codes at the end of each stroke of the axis.
When adding multiple options, put together in alphabetic order.

Name	Code	Page
AQ seal	AQ	P13
Brake	B	P13
Creep sensor	C	P13
Home limit switch	L	P14
Reversed-home specification	NM	P14
Guide with ball-retaining mechanism	RT	P14

Configuration Direction

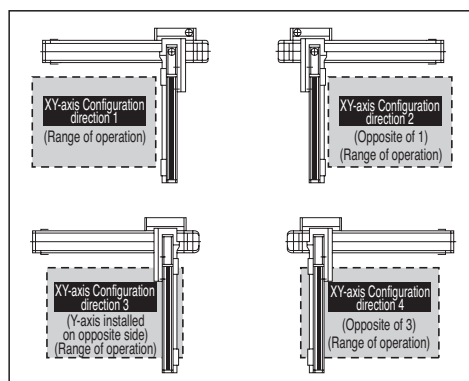

Common Specifications * [] is for the high-precision specification.

Drive system	Ball screw, rolled C10 [equivalent to rolled C5]
Positioning repeatability	±0.02mm [±0.01mm]
Backlash	0.05mm or less [0.02mm or less]
Guide	Integrated with base
Base	Material: Aluminum with white alumite treatment
X-axis motor output / lead	200W / 10mm
Y-axis motor output / lead	200W / 10mm
Z-axis motor output / lead	100W / 20mm (H), 10mm (M), 5mm (L)

Applicable Controller Specifications

Refer to page 65 for System Configuration.

Axis Configuration * [] is for the high-precision specification.

Axis Type	Model	Page
X-axis	ISA[ISPA]-LXM-□-200-10-(Stroke)-T1	P25
Y-axis	ISA[ISPA]-MYM-□-200-10-(Stroke)-T1	P22
Z-axis	ISA[ISPA]-MXM-□-100-20/10/5-(Stroke)-T1-B	P18

* In the above model name, □ indicates encoder type A (absolute) or I (incremental).



Caution

(Note 1) The stroke in the model is specified in cm (centimeters).
(Note 2) The cable length measures from the X-axis connector box to the controller. The standard lengths are 3m and 5m, but other lengths can also be specified in meters. The maximum length is 20m.
(Note 3) The rated acceleration is 0.3G. Increasing the acceleration will result in lower load capacity.
(Note 4) Please note that a longer stroke will result in a lower maximum speed.

* For other points to note, please refer to page 49.

ICSA3 [ICSPA3] -BE□MB2□

Load Capacity (kg) (Note3)

BE□MB2H

		Y-axis stroke					
		200	300	400	500	600	700
Z-axis stroke	100	3.5					
	200	3.5					
	300	3.5					
	400	3.5					
	500	3.5					

BE□MB2M

		Y-axis stroke					
		200	300	400	500	600	700
Z-axis stroke	100	9.0					
	200	9.0					
	300	9.0				7.9	
	400	9.0				6.9	
	500	9.0				5.8	

BE□MB2L

		Y-axis stroke					
		200	300	400	500	600	700
Z-axis stroke	100	19.0		18.0		13.6	
	200	19.0		17.0		12.6	
	300	19.0		15.9		11.5	
	400	19.0		14.9		10.5	
	500	19.0		13.8		9.4	

Maximum Speed by Stroke (mm/sec) (Note4)

BE□MB2H

	Stroke										
	100	200	300	400	500	600	700	800	900	1000	
X-axis	-	-	500				470		385		320
Y-axis	-	500				480		-	-	-	-
Z-axis	1000			-	-	-	-	-	-	-	-

BE□MB2M

	Stroke										
	100	200	300	400	500	600	700	800	900	1000	
X-axis	-	-	500				470		385		320
Y-axis	-	500				480		-	-	-	-
Z-axis	500			-	-	-	-	-	-	-	-

BE□MB2L

	Stroke										
	100	200	300	400	500	600	700	800	900	1000	
X-axis	-	-	500				470		385		320
Y-axis	-	500				480		-	-	-	-
Z-axis	250			-	-	-	-	-	-	-	-

Dimensions

* The dimension below is for XY-axis Configuration direction 1.

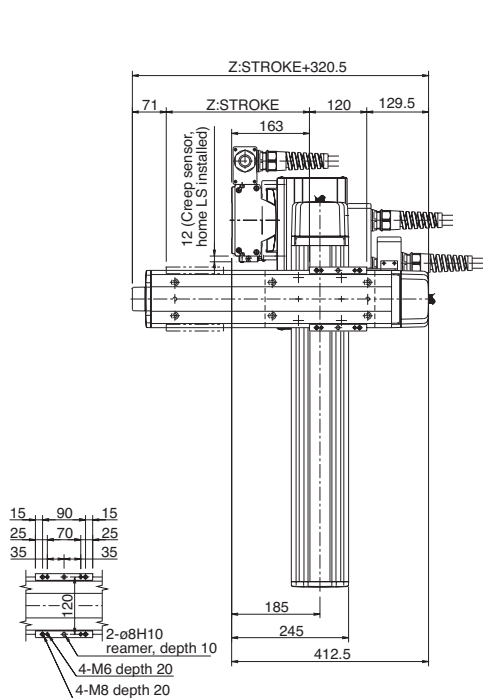

Detail View of Z-Axis slider

* The configuration position in the figure is home position. To change the home position, indicate NM in the option. Note that changing the home direction will require the actuator to be returned to IA1 for adjustment.

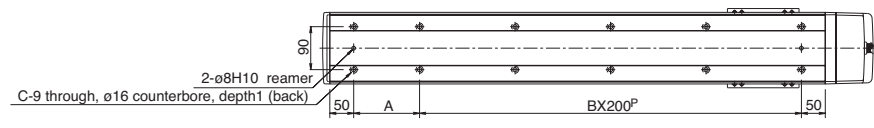
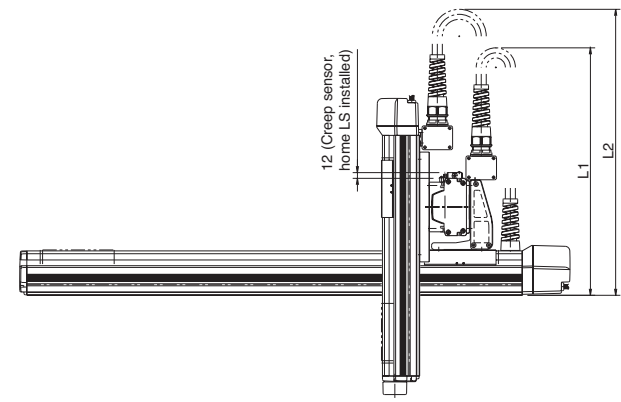
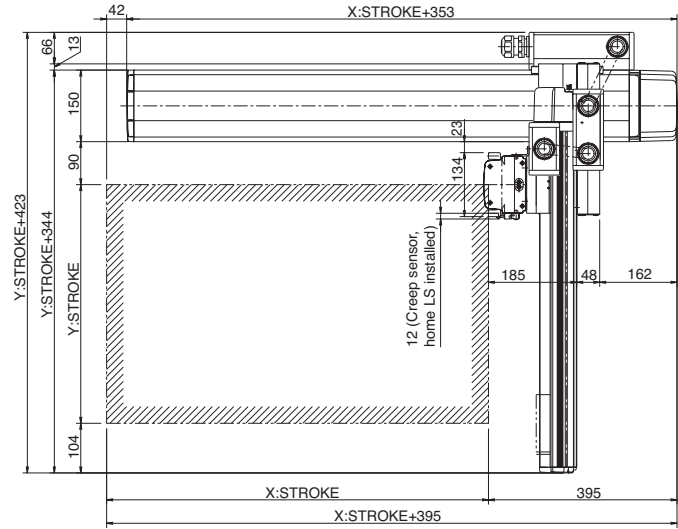

X stroke	300	400	500	600	700	800	900	1000
L1	(600)	(650)	(700)	(750)	(800)	(850)	(900)	(950)
A	238	138	238	138	238	138	238	138
B	1	2	2	3	3	4	4	5
C	6	8	8	10	10	12	12	14

Y stroke	200	300	400	500	600	700
L2	(690)	(740)	(790)	(840)	(890)	(940)

ICSA3-BE **MB3** Cartesian Robot: X-Y-Z 3-Axes Configuration
Z-Axis Base Mount Type

ICSPA3-BE **MB3** Cartesian Robot: X-Y-Z 3-Axes Configuration
Z-Axis Base Mount Type **High-Precision Specification**

Type XYB + Z-Axis Base Mount Type Stroke X-axis: 300~1000mm Y-axis: 200~700mm Z-axis: 100~500mm Load capacity 19kg ~ 5.8kg

Model specification items Series Type Encoder type X-axis stroke + options Y-axis stroke + options Z-axis stroke + options Applicable controller Cable length Cable management
(Example) ICSA3 [ICSPA3] - BE1MB3M - A - 70AQL - 40AQL - 30BL - T1 - 5L - SC - SC

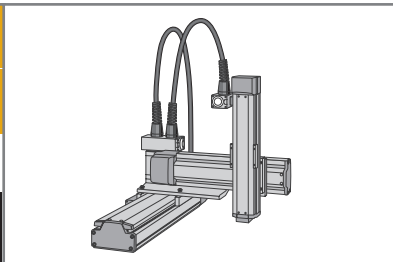

* Refer to page 51 for the details of model specification items.

Models/Specifications * [] is for the high-precision specification.

Encoder Type	XY-axis configuration direction (*1)	Z-axis type (*2)	Model
Absolute	1	H	ICSA3 [ICSPA3] -BE1MB3H-A- <input type="checkbox"/> - <input type="checkbox"/> - <input type="checkbox"/> -B-T1- <input type="checkbox"/> - <input type="checkbox"/>
		M	ICSA3 [ICSPA3] -BE1MB3M-A- <input type="checkbox"/> - <input type="checkbox"/> - <input type="checkbox"/> -B-T1- <input type="checkbox"/> - <input type="checkbox"/>
	2	H	ICSA3 [ICSPA3] -BE2MB3H-A- <input type="checkbox"/> - <input type="checkbox"/> - <input type="checkbox"/> -B-T1- <input type="checkbox"/> - <input type="checkbox"/>
		M	ICSA3 [ICSPA3] -BE2MB3M-A- <input type="checkbox"/> - <input type="checkbox"/> - <input type="checkbox"/> -B-T1- <input type="checkbox"/> - <input type="checkbox"/>
	3	H	ICSA3 [ICSPA3] -BE3MB3H-A- <input type="checkbox"/> - <input type="checkbox"/> - <input type="checkbox"/> -B-T1- <input type="checkbox"/> - <input type="checkbox"/>
		M	ICSA3 [ICSPA3] -BE3MB3M-A- <input type="checkbox"/> - <input type="checkbox"/> - <input type="checkbox"/> -B-T1- <input type="checkbox"/> - <input type="checkbox"/>
	4	H	ICSA3 [ICSPA3] -BE4MB3H-A- <input type="checkbox"/> - <input type="checkbox"/> - <input type="checkbox"/> -B-T1- <input type="checkbox"/> - <input type="checkbox"/>
		M	ICSA3 [ICSPA3] -BE4MB3M-A- <input type="checkbox"/> - <input type="checkbox"/> - <input type="checkbox"/> -B-T1- <input type="checkbox"/> - <input type="checkbox"/>
Incremental	1	H	ICSA3 [ICSPA3] -BE1MB3H-I- <input type="checkbox"/> - <input type="checkbox"/> - <input type="checkbox"/> -B-T1- <input type="checkbox"/> - <input type="checkbox"/>
		M	ICSA3 [ICSPA3] -BE1MB3M-I- <input type="checkbox"/> - <input type="checkbox"/> - <input type="checkbox"/> -B-T1- <input type="checkbox"/> - <input type="checkbox"/>
	2	H	ICSA3 [ICSPA3] -BE2MB3H-I- <input type="checkbox"/> - <input type="checkbox"/> - <input type="checkbox"/> -B-T1- <input type="checkbox"/> - <input type="checkbox"/>
		M	ICSA3 [ICSPA3] -BE2MB3M-I- <input type="checkbox"/> - <input type="checkbox"/> - <input type="checkbox"/> -B-T1- <input type="checkbox"/> - <input type="checkbox"/>
	3	H	ICSA3 [ICSPA3] -BE3MB3H-I- <input type="checkbox"/> - <input type="checkbox"/> - <input type="checkbox"/> -B-T1- <input type="checkbox"/> - <input type="checkbox"/>
		M	ICSA3 [ICSPA3] -BE3MB3M-I- <input type="checkbox"/> - <input type="checkbox"/> - <input type="checkbox"/> -B-T1- <input type="checkbox"/> - <input type="checkbox"/>
	4	H	ICSA3 [ICSPA3] -BE4MB3H-I- <input type="checkbox"/> - <input type="checkbox"/> - <input type="checkbox"/> -B-T1- <input type="checkbox"/> - <input type="checkbox"/>
		M	ICSA3 [ICSPA3] -BE4MB3M-I- <input type="checkbox"/> - <input type="checkbox"/> - <input type="checkbox"/> -B-T1- <input type="checkbox"/> - <input type="checkbox"/>

*1: Refer to the figure below for XY-axis configuration direction.
*2: The load capacity and the maximum speed may vary depending on the type of Z-axis.
Note: T1 in the above models will be T2 when operated with XSEL-P/Q type.

Explanation of Model Code

Number	Contents	Specification
<input type="checkbox"/>	X-axis stroke (Note 1)	30 : 300mm ~ 100 : 1000mm
<input type="checkbox"/>	Y-axis stroke (Note 1)	20 : 200mm ~ 70 : 700mm
<input type="checkbox"/>	Z-axis stroke (Note 1)	10 : 100mm ~ 50 : 500mm
<input type="checkbox"/>	Cable length (Note 2)	3L : 3m 5L : 5m
<input type="checkbox"/>	Y-axis/ Z-axis cable management	SC-SC : Self-standing cable CT-CT : Cable track

* The above explains the Models/Specifications chart to the left.

Options

Please add the option codes at the end of each stroke of the axis.
When adding multiple options, put together in alphabetic order.

Name	Code	Page
AQ seal	AQ	P13
Brake	B	P13
Creep sensor	C	P13
Home limit switch	L	P14
Reversed-home specification	NM	P14
Guide with ball-retaining mechanism	RT	P14

Configuration Direction

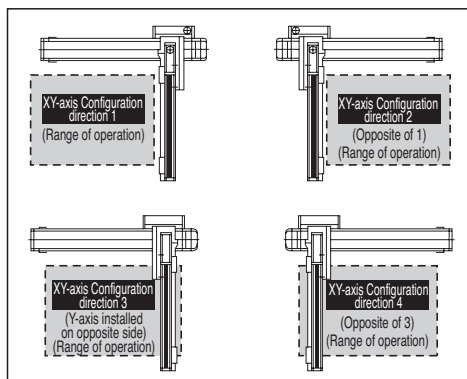

Common Specifications * [] is for the high-precision specification.

Drive system	Ball screw, rolled C10 [equivalent to rolled C5]
Positioning repeatability	±0.02mm [±0.01mm]
Backlash	0.05mm or less [0.02mm or less]
Guide	Integrated with base
Base	Material: Aluminum with white alumite treatment
X-axis motor output / lead	200W / 10mm
Y-axis motor output / lead	200W / 10mm
Z-axis motor output / lead	200W / 20mm (H), 10mm (M)

Applicable Controller Specifications

Refer to page 65 for System Configuration.

Axis Configuration * [] is for the high-precision specification.

Axis Type	Model	Page
X-axis	ISA[ISPA]-LXM- <input type="checkbox"/> -200-10-(Stroke)-T1	P25
Y-axis	ISA[ISPA]-MYM- <input type="checkbox"/> -200-10-(Stroke)-T1	P22
Z-axis	ISA[ISPA]-MXM- <input type="checkbox"/> -200-20/10-(Stroke)-T1-B	P19

*In the above model name, indicates encoder type A (absolute) or I (incremental).



Caution

(Note 1) The stroke in the model is specified in cm (centimeters).
(Note 2) The cable length measures from the X-axis connector box to the controller. The standard lengths are 3m and 5m, but other lengths can also be specified in meters. The maximum length is 20m.
(Note 3) The rated acceleration is 0.3G. Increasing the acceleration will result in lower load capacity.
(Note 4) Please note that a longer stroke will result in a lower maximum speed.

* For other points to note, please refer to page 49.

ICSA3 [ICSPA3] -BE□MB3□

Load Capacity (kg) (Note3)

BE□MB3H

		Y-axis stroke					
		200	300	400	500	600	700
Z-axis stroke	100	9.0					
	200	9.0					
	300	9.0				7.9	
	400	9.0				6.9	
	500	9.0				5.8	

BE□MB3M

		Y-axis stroke					
		200	300	400	500	600	700
Z-axis stroke	100	19.0		18.0	13.6	10.0	
	200	19.0		17.0	12.6	9.0	
	300	19.0		15.9	11.5	7.9	
	400	19.0		14.9	10.5	6.9	
	500	19.0		13.8	9.4	5.8	

Maximum Speed by Stroke (mm/sec) (Note4)

BE□MB3H

	Stroke										
	100	200	300	400	500	600	700	800	900	1000	
X-axis	-	-	500			470		385	320		
Y-axis	-	500				480		-	-	-	
Z-axis	1000		-	-	-	-	-	-	-	-	

BE□MB3M

	Stroke										
	100	200	300	400	500	600	700	800	900	1000	
X-axis	-	-	500			470		385	320		
Y-axis	-	500				480		-	-	-	
Z-axis	500		-	-	-	-	-	-	-	-	

Dimensions

* The dimension below is for XY-axis Configuration direction 1.

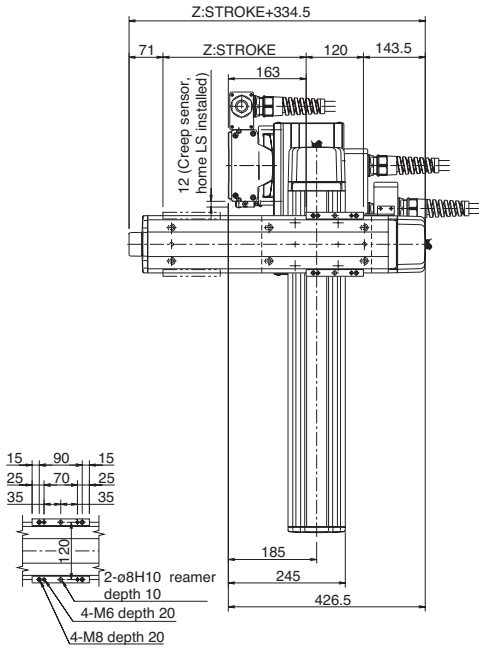

Detail View of Z-Axis slider

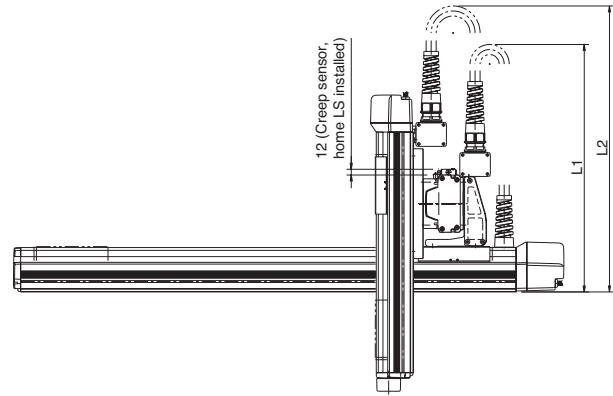
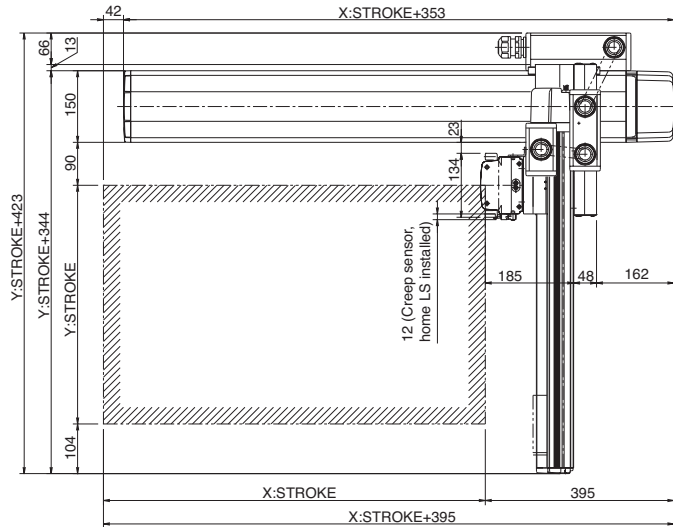

* The configuration position in the figure is home position. To change the home position, indicate NM in the option. Note that changing the home direction will require the actuator to be returned to IA1 for adjustment.

X stroke	300	400	500	600	700	800	900	1000
L1	(600)	(650)	(700)	(750)	(800)	(850)	(900)	(950)
A	238	138	238	138	238	138	238	138
B	1	2	2	3	3	4	4	5
C	6	8	8	10	10	12	12	14

Y stroke	200	300	400	500	600	700
L2	(690)	(740)	(790)	(840)	(890)	(940)

ICSA3-BF **HB1**

Cartesian Robot: X-Y-Z 3-Axes Configuration
Z-axis Base Mount Type

ICSPA3-BF **HB1**

Cartesian Robot: X-Y-Z 3-Axes Configuration
Z-axis Base Mount Type **High-Precision Specification**

Type XYB + Z-axis Base Mount Type Stroke X-axis: 1000-2500mm Y-axis: 200-700mm Z-axis: 100-500mm Load capacity 14kg ~ 3kg

Model specification items Series - Type - Encoder type - X-axis stroke + options - Y-axis stroke + options - Z-axis stroke + options - Applicable controller - Cable length - Cable management
(Example) ICSA3 (ICSPA3) - BF1HB1M - A - 100AQL - 40AQL - 30BL - T1 - 5L - CT-SC

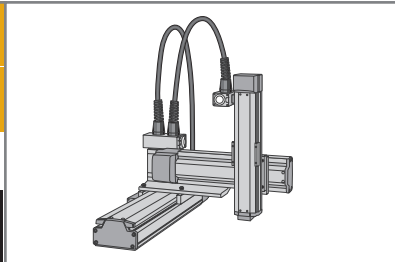

* Refer to page 51 for the details of model specification items.

Models/Specifications

* [] is for the high-precision specification.

Encoder Type	XY-axis configuration direction (*1)	Z-axis type (*2)	Model
Absolute	1	H	ICSA3 [ICSPA3] -BF1HB1H-A- <input type="checkbox"/> - <input type="checkbox"/> - <input type="checkbox"/> -B-T1- <input type="checkbox"/> - <input type="checkbox"/>
		M	ICSA3 [ICSPA3] -BF1HB1M-A- <input type="checkbox"/> - <input type="checkbox"/> - <input type="checkbox"/> -B-T1- <input type="checkbox"/> - <input type="checkbox"/>
		L	ICSA3 [ICSPA3] -BF1HB1L-A- <input type="checkbox"/> - <input type="checkbox"/> - <input type="checkbox"/> -B-T1- <input type="checkbox"/> - <input type="checkbox"/>
	2	H	ICSA3 [ICSPA3] -BF2HB1H-A- <input type="checkbox"/> - <input type="checkbox"/> - <input type="checkbox"/> -B-T1- <input type="checkbox"/> - <input type="checkbox"/>
		M	ICSA3 [ICSPA3] -BF2HB1M-A- <input type="checkbox"/> - <input type="checkbox"/> - <input type="checkbox"/> -B-T1- <input type="checkbox"/> - <input type="checkbox"/>
		L	ICSA3 [ICSPA3] -BF2HB1L-A- <input type="checkbox"/> - <input type="checkbox"/> - <input type="checkbox"/> -B-T1- <input type="checkbox"/> - <input type="checkbox"/>
	3	H	ICSA3 [ICSPA3] -BF3HB1H-A- <input type="checkbox"/> - <input type="checkbox"/> - <input type="checkbox"/> -B-T1- <input type="checkbox"/> - <input type="checkbox"/>
		M	ICSA3 [ICSPA3] -BF3HB1M-A- <input type="checkbox"/> - <input type="checkbox"/> - <input type="checkbox"/> -B-T1- <input type="checkbox"/> - <input type="checkbox"/>
		L	ICSA3 [ICSPA3] -BF3HB1L-A- <input type="checkbox"/> - <input type="checkbox"/> - <input type="checkbox"/> -B-T1- <input type="checkbox"/> - <input type="checkbox"/>
	4	H	ICSA3 [ICSPA3] -BF4HB1H-A- <input type="checkbox"/> - <input type="checkbox"/> - <input type="checkbox"/> -B-T1- <input type="checkbox"/> - <input type="checkbox"/>
		M	ICSA3 [ICSPA3] -BF4HB1M-A- <input type="checkbox"/> - <input type="checkbox"/> - <input type="checkbox"/> -B-T1- <input type="checkbox"/> - <input type="checkbox"/>
		L	ICSA3 [ICSPA3] -BF4HB1L-A- <input type="checkbox"/> - <input type="checkbox"/> - <input type="checkbox"/> -B-T1- <input type="checkbox"/> - <input type="checkbox"/>
Incremental	1	H	ICSA3 [ICSPA3] -BF1HB1H-I- <input type="checkbox"/> - <input type="checkbox"/> - <input type="checkbox"/> -B-T1- <input type="checkbox"/> - <input type="checkbox"/>
		M	ICSA3 [ICSPA3] -BF1HB1M-I- <input type="checkbox"/> - <input type="checkbox"/> - <input type="checkbox"/> -B-T1- <input type="checkbox"/> - <input type="checkbox"/>
		L	ICSA3 [ICSPA3] -BF1HB1L-I- <input type="checkbox"/> - <input type="checkbox"/> - <input type="checkbox"/> -B-T1- <input type="checkbox"/> - <input type="checkbox"/>
	2	H	ICSA3 [ICSPA3] -BF2HB1H-I- <input type="checkbox"/> - <input type="checkbox"/> - <input type="checkbox"/> -B-T1- <input type="checkbox"/> - <input type="checkbox"/>
		M	ICSA3 [ICSPA3] -BF2HB1M-I- <input type="checkbox"/> - <input type="checkbox"/> - <input type="checkbox"/> -B-T1- <input type="checkbox"/> - <input type="checkbox"/>
		L	ICSA3 [ICSPA3] -BF2HB1L-I- <input type="checkbox"/> - <input type="checkbox"/> - <input type="checkbox"/> -B-T1- <input type="checkbox"/> - <input type="checkbox"/>
	3	H	ICSA3 [ICSPA3] -BF3HB1H-I- <input type="checkbox"/> - <input type="checkbox"/> - <input type="checkbox"/> -B-T1- <input type="checkbox"/> - <input type="checkbox"/>
		M	ICSA3 [ICSPA3] -BF3HB1M-I- <input type="checkbox"/> - <input type="checkbox"/> - <input type="checkbox"/> -B-T1- <input type="checkbox"/> - <input type="checkbox"/>
		L	ICSA3 [ICSPA3] -BF3HB1L-I- <input type="checkbox"/> - <input type="checkbox"/> - <input type="checkbox"/> -B-T1- <input type="checkbox"/> - <input type="checkbox"/>
	4	H	ICSA3 [ICSPA3] -BF4HB1H-I- <input type="checkbox"/> - <input type="checkbox"/> - <input type="checkbox"/> -B-T1- <input type="checkbox"/> - <input type="checkbox"/>
		M	ICSA3 [ICSPA3] -BF4HB1M-I- <input type="checkbox"/> - <input type="checkbox"/> - <input type="checkbox"/> -B-T1- <input type="checkbox"/> - <input type="checkbox"/>
		L	ICSA3 [ICSPA3] -BF4HB1L-I- <input type="checkbox"/> - <input type="checkbox"/> - <input type="checkbox"/> -B-T1- <input type="checkbox"/> - <input type="checkbox"/>

*1: Refer to the figure below for XY-axis configuration direction.
*2: The load capacity and the maximum speed may vary depending on the type of Z-axis.
Note: T1 in the above models will be T2 when operated with XSEL-P/Q type.

Explanation of Model Code

Number	Contents	Specification
①	X-axis stroke (Note 1)	100 : 1000mm ~ 250 : 2500mm
②	Y-axis stroke (Note 1)	20 : 200mm ~ 70 : 700mm
③	Z-axis stroke (Note 1)	10 : 100mm ~ 50 : 500mm
④	Cable length (Note 2)	3L : 3m 5L : 5m
⑤	Y-axis/ Z-axis cable management	CT-SC : Self-standing cable (*3) CT-CT : Cable track

* The above explains the Models/Specifications chart to the left.
*3 Only cable track can be specified for the Y-axis cable management with model # BF□HB1□.

Options

Please add the option codes at the end of each stroke of the axis. When adding multiple options, put together in alphabetic order.

Name	Code	Page
AQ seal	AQ	P13
Brake	B	P13
Creep sensor	C	P13
Home limit switch	L	P14
Reversed-home specification	NM	P14
Guide with ball-retaining mechanism	RT	P14

Configuration Direction

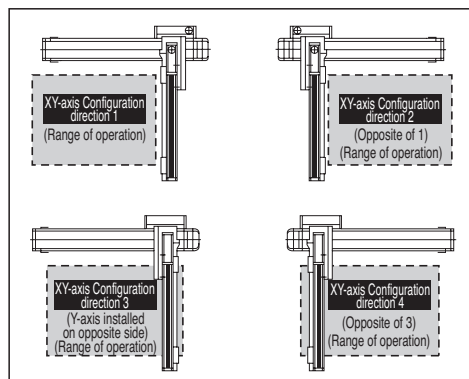

Axis Configuration

* [] is for the high-precision specification.

Axis Type	Model	Page
X-axis	ISA[ISPA]-LXM□-□-400-20-(Stroke)-T1	P28
Y-axis	ISA[ISPA]-MYM□-□-200-20-(Stroke)-T1	P22
Z-axis	ISA[ISPA]-SXM□-□-60-16/8/4-(Stroke)-T1-B	P15

* In the above model name, □ indicates encoder type A (absolute) or I (incremental).

Common Specifications

* [] is for the high-precision specification.

Drive system	Ball screw, rolled C10 [equivalent to rolled C5]
Positioning repeatability	±0.02mm [±0.01mm]
Backlash	0.05mm or less [0.02mm or less]
Guide	Integrated with base
Base	Material: Aluminum with white alumite treatment
X-axis motor output / lead	400W / 20mm
Y-axis motor output / lead	200W / 20mm
Z-axis motor output / lead	60W / 16mm (H), 8mm (M), 4mm (L)

Applicable Controller Specifications

Refer to page 65 for System Configuration.



Caution

(Note 1) The stroke in the model is specified in cm (centimeters).
(Note 2) The cable length measures from the X-axis connector box to the controller. The standard lengths are 3m and 5m, but other lengths can also be specified in meters. The maximum length is 20m.
(Note 3) The rated acceleration is 0.3G. Increasing the acceleration will result in lower load capacity.
(Note 4) Please note that a longer stroke will result in a lower maximum speed.

* For other points to note, please refer to page 49.

ICSA3 [ICSPA3] -BF□HB1□

Load Capacity (kg) (Note3)

■BF□HB1H

		Y-axis stroke					
		200	300	400	500	600	700
Z-axis stroke	100	3.0					
	200	3.0					
	300	3.0					
	400	3.0					
	500	3.0					

■BF□HB1M

		Y-axis stroke					
		200	300	400	500	600	700
Z-axis stroke	100	6.0					
	200	6.0					
	300	6.0					
	400	6.0					
	500	6.0					

■BF□HB1L

		Y-axis stroke					
		200	300	400	500	600	700
Z-axis stroke	100	14.0					
	200	14.0					13.5
	300	14.0					12.9
	300	14.0					12.3
	500	14.0					

Maximum Speed by Stroke (mm/sec) (Note4)

■BF□HB1H

	Stroke															
	100	200~500	600	700	1000~1400	1500	1600	1700	1800	1900	2000	2100	2200	2300	2400	2500
X-axis	-	-	-	-	1000	950	830	740	650	590	540	490	440	410	370	300
Y-axis	1000				-	-	-	-	-	-	-	-	-	-	-	-
Z-axis	800			-	-	-	-	-	-	-	-	-	-	-	-	-

■BF□HB1M

	Stroke															
	100	200~500	600	700	1000~1400	1500	1600	1700	1800	1900	2000	2100	2200	2300	2400	2500
X-axis	-	-	-	-	1000	950	830	740	650	590	540	490	440	410	370	300
Y-axis	1000				-	-	-	-	-	-	-	-	-	-	-	-
Z-axis	400			-	-	-	-	-	-	-	-	-	-	-	-	-

■BF□HB1L

	Stroke															
	100	200~500	600	700	1000~1400	1500	1600	1700	1800	1900	2000	2100	2200	2300	2400	2500
X-axis	-	-	-	-	1000	950	830	740	650	590	540	490	440	410	370	300
Y-axis	1000				-	-	-	-	-	-	-	-	-	-	-	-
Z-axis	200			-	-	-	-	-	-	-	-	-	-	-	-	-

Dimensions

* The dimension below is for XY-axis Configuration direction 1.

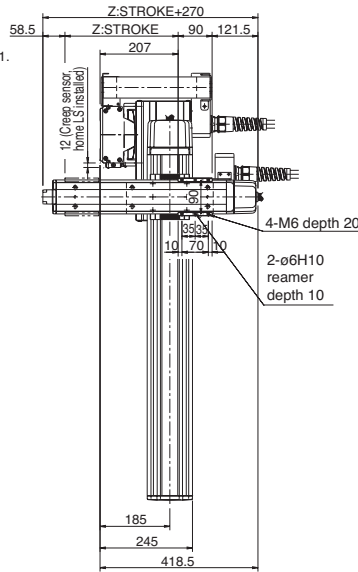

* The configuration position in the figure is home position. To change the home position, indicate NM in the option. Note that changing the home direction will require the actuator to be returned to IAI for adjustment.

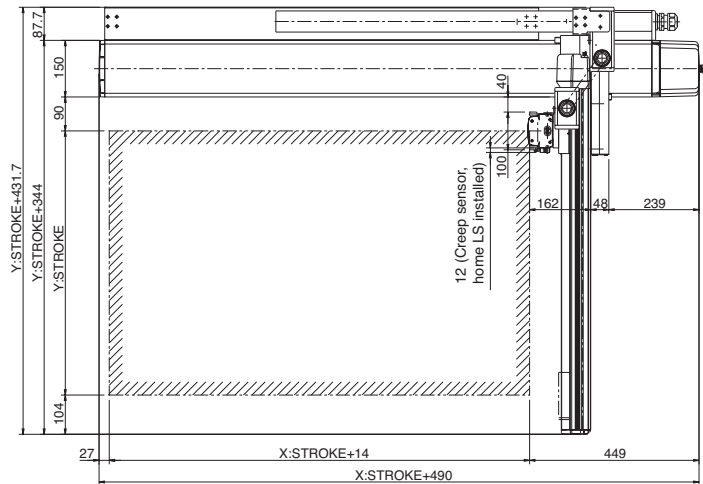

X st	A	B	C	D	Y st	L
1000	225	0	0	12	200	(650)
1100	275	0	0	12	300	(700)
1200	325	0	0	12	400	(750)
1300	375	0	0	12	500	(800)
1400	425	0	0	12	600	(850)
1500	475	0	0	12	700	(900)
1600	525	0	0	12		
1700	575	0	0	12		
1800	200	425	0	16		
1900	200	475	0	16		
2000	200	525	0	16		
2100	200	575	0	16		
2200	200	200	425	20		
2300	200	200	475	20		
2400	200	200	525	20		
2500	200	200	575	20		

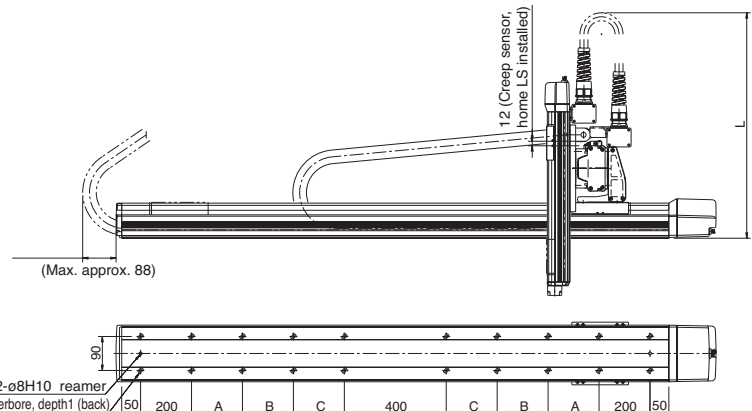

ICSA3-BF **HB2**

Cartesian Robot: X-Y-Z 3-Axes Configuration
Z-axis Base Mount Type

ICSPA3-BF **HB2**

Cartesian Robot: X-Y-Z 3-Axes Configuration
Z-axis Base Mount Type **High-Precision Specification**

Type XYB + Z-axis Base Mount Type **Stroke** X-axis: 1000-2500mm Y-axis: 200-700mm Z-axis: 100-500mm **Load capacity** 19kg ~ 3.5kg

Model specification items Series - Type - Encoder type - X-axis stroke + options - Y-axis stroke + options - Z-axis stroke + options - Applicable controller - Cable length - Cable management
(Example) ICSA3 (ICSPA3) - BFHB2M - A - 100AQL - 40AQL - 30BL - T1 - 5L - CT - SC

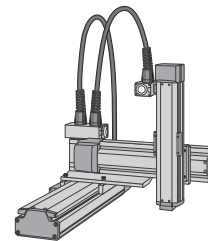

* Refer to page 51 for the details of model specification items.

Models/Specifications

* [] is for the high-precision specification.

Encoder Type	XY-axis configuration direction (*1)	Z-axis type (**2)	Model
Absolute	1	H	ICSA3 [ICSPA3] -BF1HB2H-A- <input type="checkbox"/> - <input type="checkbox"/> - <input type="checkbox"/> -B-T1- <input type="checkbox"/> - <input type="checkbox"/>
		M	ICSA3 [ICSPA3] -BF1HB2M-A- <input type="checkbox"/> - <input type="checkbox"/> - <input type="checkbox"/> -B-T1- <input type="checkbox"/> - <input type="checkbox"/>
		L	ICSA3 [ICSPA3] -BF1HB2L-A- <input type="checkbox"/> - <input type="checkbox"/> - <input type="checkbox"/> -B-T1- <input type="checkbox"/> - <input type="checkbox"/>
	2	H	ICSA3 [ICSPA3] -BF2HB2H-A- <input type="checkbox"/> - <input type="checkbox"/> - <input type="checkbox"/> -B-T1- <input type="checkbox"/> - <input type="checkbox"/>
		M	ICSA3 [ICSPA3] -BF2HB2M-A- <input type="checkbox"/> - <input type="checkbox"/> - <input type="checkbox"/> -B-T1- <input type="checkbox"/> - <input type="checkbox"/>
		L	ICSA3 [ICSPA3] -BF2HB2L-A- <input type="checkbox"/> - <input type="checkbox"/> - <input type="checkbox"/> -B-T1- <input type="checkbox"/> - <input type="checkbox"/>
	3	H	ICSA3 [ICSPA3] -BF3HB2H-A- <input type="checkbox"/> - <input type="checkbox"/> - <input type="checkbox"/> -B-T1- <input type="checkbox"/> - <input type="checkbox"/>
		M	ICSA3 [ICSPA3] -BF3HB2M-A- <input type="checkbox"/> - <input type="checkbox"/> - <input type="checkbox"/> -B-T1- <input type="checkbox"/> - <input type="checkbox"/>
		L	ICSA3 [ICSPA3] -BF3HB2L-A- <input type="checkbox"/> - <input type="checkbox"/> - <input type="checkbox"/> -B-T1- <input type="checkbox"/> - <input type="checkbox"/>
	4	H	ICSA3 [ICSPA3] -BF4HB2H-A- <input type="checkbox"/> - <input type="checkbox"/> - <input type="checkbox"/> -B-T1- <input type="checkbox"/> - <input type="checkbox"/>
		M	ICSA3 [ICSPA3] -BF4HB2M-A- <input type="checkbox"/> - <input type="checkbox"/> - <input type="checkbox"/> -B-T1- <input type="checkbox"/> - <input type="checkbox"/>
		L	ICSA3 [ICSPA3] -BF4HB2L-A- <input type="checkbox"/> - <input type="checkbox"/> - <input type="checkbox"/> -B-T1- <input type="checkbox"/> - <input type="checkbox"/>
Incremental	1	H	ICSA3 [ICSPA3] -BF1HB2H-I- <input type="checkbox"/> - <input type="checkbox"/> - <input type="checkbox"/> -B-T1- <input type="checkbox"/> - <input type="checkbox"/>
		M	ICSA3 [ICSPA3] -BF1HB2M-I- <input type="checkbox"/> - <input type="checkbox"/> - <input type="checkbox"/> -B-T1- <input type="checkbox"/> - <input type="checkbox"/>
		L	ICSA3 [ICSPA3] -BF1HB2L-I- <input type="checkbox"/> - <input type="checkbox"/> - <input type="checkbox"/> -B-T1- <input type="checkbox"/> - <input type="checkbox"/>
	2	H	ICSA3 [ICSPA3] -BF2HB2H-I- <input type="checkbox"/> - <input type="checkbox"/> - <input type="checkbox"/> -B-T1- <input type="checkbox"/> - <input type="checkbox"/>
		M	ICSA3 [ICSPA3] -BF2HB2M-I- <input type="checkbox"/> - <input type="checkbox"/> - <input type="checkbox"/> -B-T1- <input type="checkbox"/> - <input type="checkbox"/>
		L	ICSA3 [ICSPA3] -BF2HB2L-I- <input type="checkbox"/> - <input type="checkbox"/> - <input type="checkbox"/> -B-T1- <input type="checkbox"/> - <input type="checkbox"/>
	3	H	ICSA3 [ICSPA3] -BF3HB2H-I- <input type="checkbox"/> - <input type="checkbox"/> - <input type="checkbox"/> -B-T1- <input type="checkbox"/> - <input type="checkbox"/>
		M	ICSA3 [ICSPA3] -BF3HB2M-I- <input type="checkbox"/> - <input type="checkbox"/> - <input type="checkbox"/> -B-T1- <input type="checkbox"/> - <input type="checkbox"/>
		L	ICSA3 [ICSPA3] -BF3HB2L-I- <input type="checkbox"/> - <input type="checkbox"/> - <input type="checkbox"/> -B-T1- <input type="checkbox"/> - <input type="checkbox"/>
	4	H	ICSA3 [ICSPA3] -BF4HB2H-I- <input type="checkbox"/> - <input type="checkbox"/> - <input type="checkbox"/> -B-T1- <input type="checkbox"/> - <input type="checkbox"/>
		M	ICSA3 [ICSPA3] -BF4HB2M-I- <input type="checkbox"/> - <input type="checkbox"/> - <input type="checkbox"/> -B-T1- <input type="checkbox"/> - <input type="checkbox"/>
		L	ICSA3 [ICSPA3] -BF4HB2L-I- <input type="checkbox"/> - <input type="checkbox"/> - <input type="checkbox"/> -B-T1- <input type="checkbox"/> - <input type="checkbox"/>

*1: Refer to the figure below for XY-axis configuration direction.

*2: The load capacity and the maximum speed may vary depending on the type of Z-axis.

Note: T1 in the above models will be T2 when operated with XSEL-P/Q type.

Explanation of Model Code

Number	Contents	Specification
①	X-axis stroke (Note 1)	100 : 1000mm ~ 250 : 2500mm
②	Y-axis stroke (Note 1)	20 : 200mm ~ 70 : 700mm
③	Z-axis stroke (Note 1)	10 : 100mm ~ 50 : 500mm
④	Cable length (Note 2)	3L : 3m 5L : 5m
⑤	Y-axis/ Z-axis cable management	CT-SC : Self-standing cable (*3) CT-CT : Cable track

* The above explains the Models/Specifications chart to the left.

*3 Only cable track can be specified for the Y-axis cable management with model # BF□HB2□.

Options

Please add the option codes at the end of each stroke of the axis. When adding multiple options, put together in alphabetic order.

Name	Code	Page
AQ seal	AQ	P13
Brake	B	P13
Creep sensor	C	P13
Home limit switch	L	P14
Reversed-home specification	NM	P14
Guide with ball-retaining mechanism	RT	P14

Configuration Direction

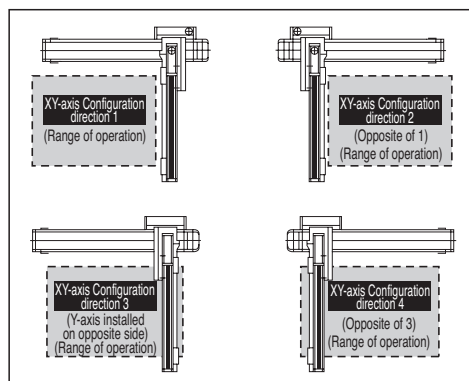

Common Specifications

* [] is for the high-precision specification.

Drive system	Ball screw, rolled C10 [equivalent to rolled C5]
Positioning repeatability	±0.02mm [±0.01mm]
Backlash	0.05mm or less [0.02mm or less]
Guide	Integrated with base
Base	Material: Aluminum with white alumite treatment
X-axis motor output / lead	400W / 20mm
Y-axis motor output / lead	200W / 20mm
Z-axis motor output / lead	100W / 20mm (H), 10mm (M), 5mm (L)

Applicable Controller Specifications

Refer to page 65 for System Configuration.

Axis Configuration

* [] is for the high-precision specification.

Axis Type	Model	Page
X-axis	ISA[ISPA]-LXM-□-400-20-(Stroke)-T1	P28
Y-axis	ISA[ISPA]-MYM-□-200-20-(Stroke)-T1	P22
Z-axis	ISA[ISPA]-MXM-□-100-20/10/5-(Stroke)-T1-B	P18

*In the above model name, □ indicates encoder type A (absolute) or I (incremental).



Caution

(Note 1) The stroke in the model is specified in cm (centimeters).

(Note 2) The cable length measures from the X-axis connector box to the controller. The standard lengths are 3m and 5m, but other lengths can also be specified in meters. The maximum length is 20m.

(Note 3) The rated acceleration is 0.3G. Increasing the acceleration will result in lower load capacity.

(Note 4) Please note that a longer stroke will result in a lower maximum speed.

* For other points to note, please refer to page 49.

ICSA3 [ICSPA3] -BF□HB2□

Load Capacity (kg) (Note3)

BF□HB2H

		Y-axis stroke					
		200	300	400	500	600	700
Z-axis stroke	100	3.5					
	200	3.5					
	300	3.5					
	400	3.5					
	500	3.5					

BF□HB2M

		Y-axis stroke					
		200	300	400	500	600	700
Z-axis stroke	100	9.0					
	200	9.0					
	300	9.0				7.9	
	400	9.0				6.9	
	500	9.0				5.8	

BF□HB2L

		Y-axis stroke					
		200	300	400	500	600	700
Z-axis stroke	100	19.0	18.0	13.6	10.0		
	200	19.0	17.0	12.6	9.0		
	300	19.0	15.9	11.5	7.9		
	400	19.0	14.9	10.5	6.9		
	500	19.0	13.8	9.4	5.8		

Maximum Speed by Stroke (mm/sec) (Note4)

BF□HB2H

	Stroke															
	100	200~500	600	700	1000~1400	1500	1600	1700	1800	1900	2000	2100	2200	2300	2400	2500
X-axis	-	-	-	-	1000	950	830	740	650	590	540	490	440	410	370	300
Y-axis	-	1000				-	-	-	-	-	-	-	-	-	-	-
Z-axis	1000		-	-	-	-	-	-	-	-	-	-	-	-	-	-

BF□HB2M

	Stroke															
	100	200~500	600	700	1000~1400	1500	1600	1700	1800	1900	2000	2100	2200	2300	2400	2500
X-axis	-	-	-	-	1000	950	830	740	650	590	540	490	440	410	370	300
Y-axis	-	1000				-	-	-	-	-	-	-	-	-	-	-
Z-axis	500		-	-	-	-	-	-	-	-	-	-	-	-	-	-

BF□HB2L

	Stroke															
	100	200~500	600	700	100~1400	1500	1600	1700	1800	1900	2000	2100	2200	2300	2400	2500
X-axis	-	-	-	-	1000	950	830	740	650	590	540	490	440	410	370	300
Y-axis	-	1000				-	-	-	-	-	-	-	-	-	-	-
Z-axis	250		-	-	-	-	-	-	-	-	-	-	-	-	-	-

Dimensions

* The dimension below is for XY-axis Configuration direction 1.

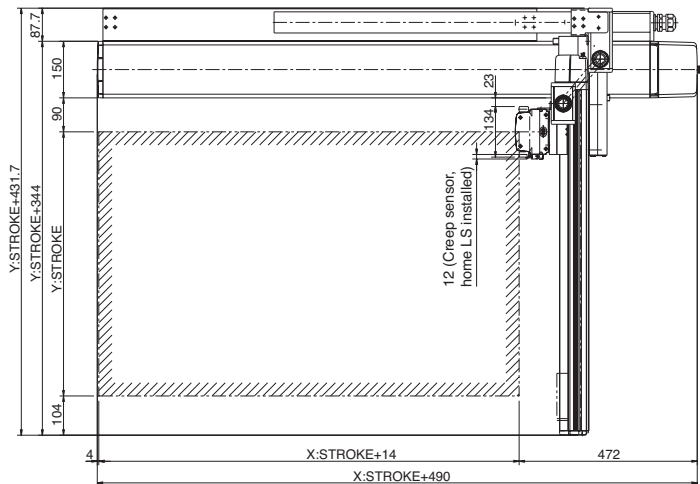
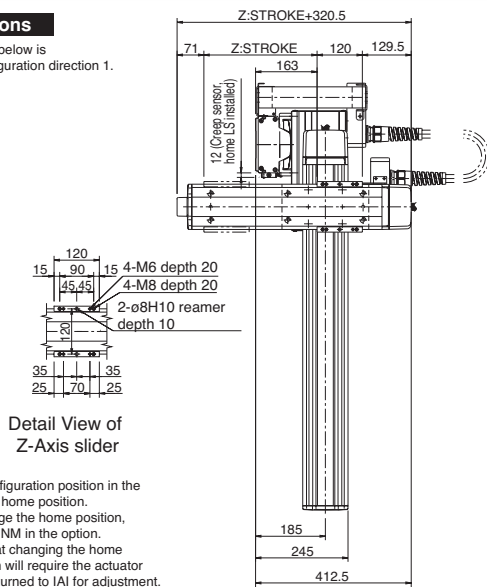

X st	A	B	C	D	Y st	L
1000	225	0	0	12	200	(650)
1100	275	0	0	12	300	(700)
1200	325	0	0	12	400	(750)
1300	375	0	0	12	500	(800)
1400	425	0	0	12	600	(850)
1500	475	0	0	12	700	(900)
1600	525	0	0	12		
1700	575	0	0	12		
1800	200	425	0	16		
1900	200	475	0	16		
2000	200	525	0	16		
2100	200	575	0	16		
2200	200	200	425	20		
2300	200	200	475	20		
2400	200	200	525	20		
2500	200	200	575	20		

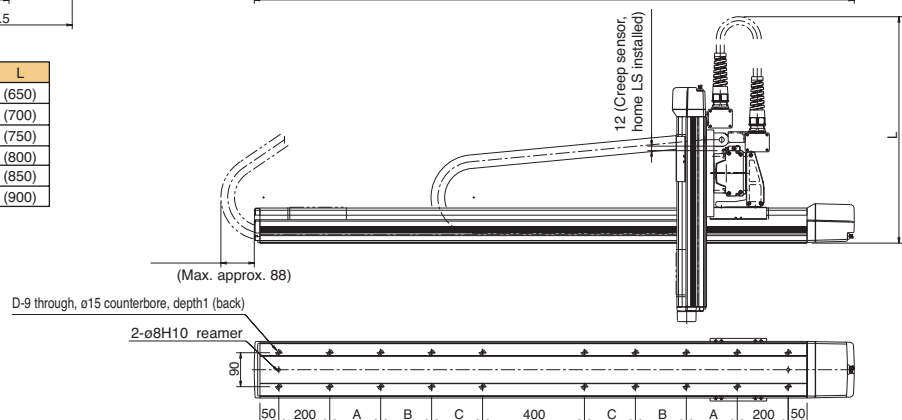

ICSA3-BF **HB3**

Cartesian Robot: X-Y-Z 3-Axes Configuration
Z-Axis Base Mount Type

ICSPA3-BF **HB3**

Cartesian Robot: X-Y-Z 3-Axes Configuration
Z-Axis Base Mount Type **High-Precision Specification**

Type XYB + Z-Axis Base Mount Type Stroke X-axis: 1000-2500mm Y-axis: 200-700mm Z-axis: 100-500mm Load capacity 19kg ~ 5.8kg

Model specification items Series - Type - Encoder type - X-axis stroke + options - Y-axis stroke + options - Z-axis stroke + options - Applicable controller - Cable length - Cable management
(Example) ICSA3 (ICSPA3) - BF1HB3M - A - 100AQL - 40AQL - 30BL - T1 - 5L - CT-SC

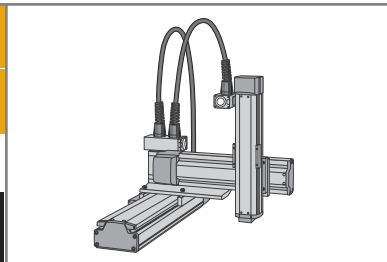

* Refer to page 51 for the details of model specification items.

Models/Specifications * [] is for the high-precision specification.

Encoder Type	XY-axis configuration direction (*1)	Z-axis type (*2)	Model
Absolute	1	H	ICSA3 [ICSPA3] -BF1HB3H-A- <input type="checkbox"/> - <input type="checkbox"/> - <input type="checkbox"/> -B-T1- <input type="checkbox"/> - <input type="checkbox"/>
		M	ICSA3 [ICSPA3] -BF1HB3M-A- <input type="checkbox"/> - <input type="checkbox"/> - <input type="checkbox"/> -B-T1- <input type="checkbox"/> - <input type="checkbox"/>
	2	H	ICSA3 [ICSPA3] -BF2HB3H-A- <input type="checkbox"/> - <input type="checkbox"/> - <input type="checkbox"/> -B-T1- <input type="checkbox"/> - <input type="checkbox"/>
		M	ICSA3 [ICSPA3] -BF2HB3M-A- <input type="checkbox"/> - <input type="checkbox"/> - <input type="checkbox"/> -B-T1- <input type="checkbox"/> - <input type="checkbox"/>
	3	H	ICSA3 [ICSPA3] -BF3HB3H-A- <input type="checkbox"/> - <input type="checkbox"/> - <input type="checkbox"/> -B-T1- <input type="checkbox"/> - <input type="checkbox"/>
		M	ICSA3 [ICSPA3] -BF3HB3M-A- <input type="checkbox"/> - <input type="checkbox"/> - <input type="checkbox"/> -B-T1- <input type="checkbox"/> - <input type="checkbox"/>
	4	H	ICSA3 [ICSPA3] -BF4HB3H-A- <input type="checkbox"/> - <input type="checkbox"/> - <input type="checkbox"/> -B-T1- <input type="checkbox"/> - <input type="checkbox"/>
		M	ICSA3 [ICSPA3] -BF4HB3M-A- <input type="checkbox"/> - <input type="checkbox"/> - <input type="checkbox"/> -B-T1- <input type="checkbox"/> - <input type="checkbox"/>
Incremental	1	H	ICSA3 [ICSPA3] -BF1HB3H-I- <input type="checkbox"/> - <input type="checkbox"/> - <input type="checkbox"/> -B-T1- <input type="checkbox"/> - <input type="checkbox"/>
		M	ICSA3 [ICSPA3] -BF1HB3M-I- <input type="checkbox"/> - <input type="checkbox"/> - <input type="checkbox"/> -B-T1- <input type="checkbox"/> - <input type="checkbox"/>
	2	H	ICSA3 [ICSPA3] -BF2HB3H-I- <input type="checkbox"/> - <input type="checkbox"/> - <input type="checkbox"/> -B-T1- <input type="checkbox"/> - <input type="checkbox"/>
		M	ICSA3 [ICSPA3] -BF2HB3M-I- <input type="checkbox"/> - <input type="checkbox"/> - <input type="checkbox"/> -B-T1- <input type="checkbox"/> - <input type="checkbox"/>
	3	H	ICSA3 [ICSPA3] -BF3HB3H-I- <input type="checkbox"/> - <input type="checkbox"/> - <input type="checkbox"/> -B-T1- <input type="checkbox"/> - <input type="checkbox"/>
		M	ICSA3 [ICSPA3] -BF3HB3M-I- <input type="checkbox"/> - <input type="checkbox"/> - <input type="checkbox"/> -B-T1- <input type="checkbox"/> - <input type="checkbox"/>
	4	H	ICSA3 [ICSPA3] -BF4HB3H-I- <input type="checkbox"/> - <input type="checkbox"/> - <input type="checkbox"/> -B-T1- <input type="checkbox"/> - <input type="checkbox"/>
		M	ICSA3 [ICSPA3] -BF4HB3M-I- <input type="checkbox"/> - <input type="checkbox"/> - <input type="checkbox"/> -B-T1- <input type="checkbox"/> - <input type="checkbox"/>

*1: Refer to the figure below for XY-axis configuration direction.
*2: The load capacity and the maximum speed may vary depending on the type of Z-axis.
Note: T1 in the above models will be T2 when operated with XSEL-P/Q type.

Explanation of Model Code

Number	Contents	Specification
①	X-axis stroke (Note 1)	100 : 1000mm ~ 250 : 2500mm
②	Y-axis stroke (Note 1)	20 : 200mm ~ 70 : 700mm
③	Z-axis stroke (Note 1)	10 : 100mm ~ 50 : 500mm
④	Cable length (Note 2)	3L : 3m 5L : 5m
⑤	Y-axis/ Z-axis cable management	CT-SC : Self-standing cable (*3) CT-CT : Cable track

* The above explains the Models/Specifications chart to the left.
*3 Only cable track can be specified for the Y-axis cable management with model # BF□HB3□.

Options

Please add the option codes at the end of each stroke of the axis.
When adding multiple options, put together in alphabetic order.

Name	Code	Page
AQ seal	AQ	P13
Brake	B	P13
Creep sensor	C	P13
Home limit switch	L	P14
Reversed-home specification	NM	P14
Guide with ball-retaining mechanism	RT	P14

Configuration Direction

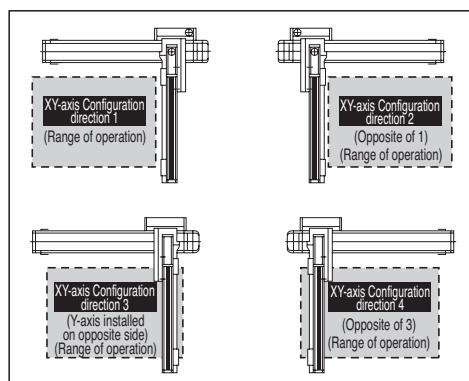

Common Specifications * [] is for the high-precision specification.

Drive system	Ball screw, rolled C10 [equivalent to rolled C5]
Positioning repeatability	±0.02mm [±0.01mm]
Backlash	0.05mm or less [0.02mm or less]
Guide	Integrated with base
Base	Material: Aluminum with white alumite treatment
X-axis motor output / lead	400W / 20mm
Y-axis motor output / lead	200W / 20mm
Z-axis motor output / lead	200W / 20mm (H), 10mm (M)

Applicable Controller Specifications

Refer to page 65 for System Configuration.

Axis Configuration * [] is for the high-precision specification.

Axis Type	Model	Page
X-axis	ISA[ISPA]-LXM□-□-400-20-(Stroke)-T1	P28
Y-axis	ISA[ISPA]-MYM□-□-200-20-(Stroke)-T1	P22
Z-axis	ISA[ISPA]-MXM□-□-200-20/10-(Stroke)-T1-B	P19

* In the above model name, □ indicates encoder type A (absolute) or I (incremental).



Caution

(Note 1) The stroke in the model is specified in cm (centimeters).
(Note 2) The cable length measures from the X-axis connector box to the controller. The standard lengths are 3m and 5m, but other lengths can also be specified in meters. The maximum length is 20m.
(Note 3) The rated acceleration is 0.3G. Increasing the acceleration will result in lower load capacity.
(Note 4) Please note that a longer stroke will result in a lower maximum speed.

* For other points to note, please refer to page 49.

ICSA3 [ICSPA3] -BF□HB3□

Load Capacity (kg) (Note3)

BF□HB3H

		Y-axis stroke					
		200	300	400	500	600	700
Z-axis stroke	100	9.0					
	200	9.0					
	300	9.0				7.9	
	400	9.0				6.9	
	500	9.0				5.8	

BF□HB3M

		Y-axis stroke					
		200	300	400	500	600	700
Z-axis stroke	100	19.0		18.0	13.6	10.0	
	200	19.0		17.0	12.6	9.0	
	300	19.0		15.9	11.5	7.9	
	400	19.0		14.9	10.5	6.9	
	500	19.0		13.8	9.4	5.8	

Maximum Speed by Stroke (mm/sec) (Note4)

BF□HB3H

	Stroke																
	100	200~500	600	700	1000~1400	1500	1600	1700	1800	1900	2000	2100	2200	2300	2400	2500	
X-axis	-	-	-	-	1000	950	830	740	650	590	540	490	440	410	370	300	
Y-axis	-	1000				-	-	-	-	-	-	-	-	-	-	-	-
Z-axis	1000		-	-	-	-	-	-	-	-	-	-	-	-	-	-	

BF□HB3M

	Stroke																
	100	200~500	600	700	1000~1400	1500	1600	1700	1800	1900	2000	2100	2200	2300	2400	2500	
X-axis	-	-	-	-	1000	950	830	740	650	590	540	490	440	410	370	300	
Y-axis	-	1000				-	-	-	-	-	-	-	-	-	-	-	-
Z-axis	500		-	-	-	-	-	-	-	-	-	-	-	-	-	-	

Dimensions

* The dimension below is for XY-axis Configuration direction 1.

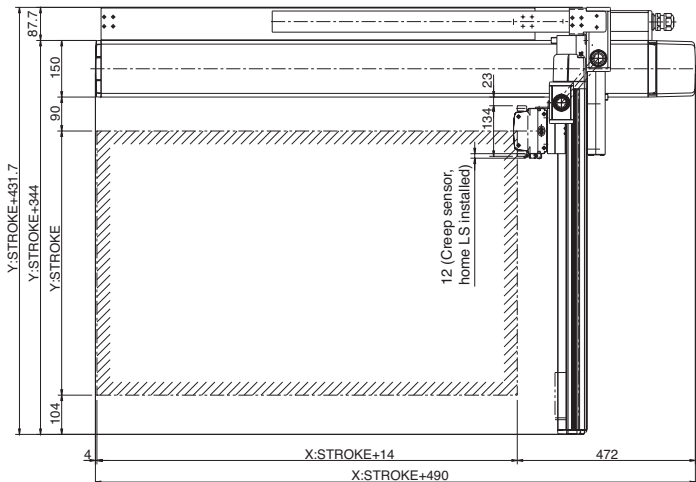
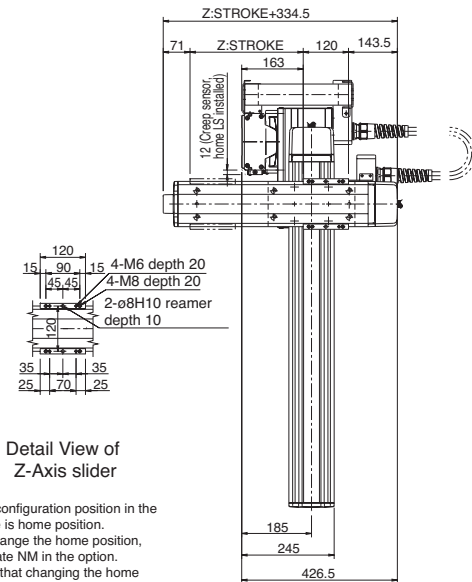

X st	A	B	C	D	Y st	L
1000	225	0	0	12	200	(650)
1100	275	0	0	12	300	(700)
1200	325	0	0	12	400	(750)
1300	375	0	0	12	500	(800)
1400	425	0	0	12	600	(850)
1500	475	0	0	12	700	(900)
1600	525	0	0	12		
1700	575	0	0	12		
1800	200	425	0	16		
1900	200	475	0	16		
2000	200	525	0	16		
2100	200	575	0	16		
2200	200	200	425	20		
2300	200	200	475	20		
2400	200	200	525	20		
2500	200	200	575	20		

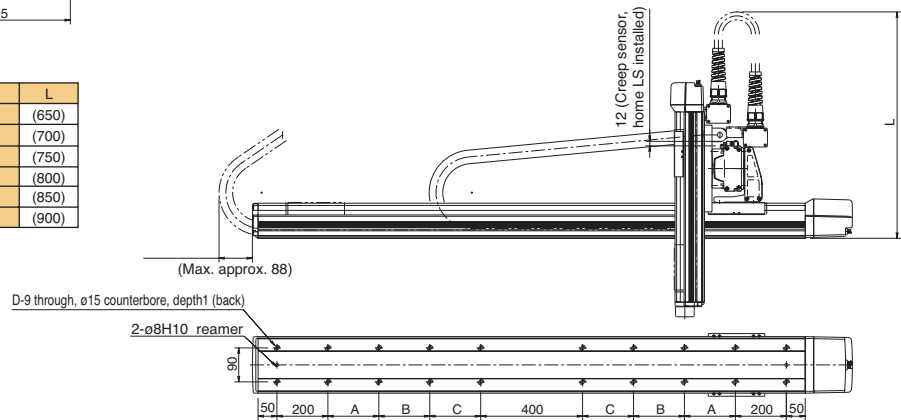

ICSA3-BA MS1

Cartesian Robot: X-Y-Z 3-Axes Configuration
Z-Axis Slider Mount Type

ICSPA3-BA MS1

Cartesian Robot: X-Y-Z 3-Axes Configuration
Z-Axis Slider Mount Type **High-Precision Specification**

Type XYB + Z-Axis Slider Mount Type **Stroke** X-axis: 100-600mm Y-axis: 100-400mm Z-axis: 100-300mm **Load capacity** 11kg ~ 1.6kg

Model specification items Series - Type - Encoder type - X-axis stroke + options - Y-axis stroke + options - Z-axis stroke + options - Applicable controller - Cable length - Cable management
(Example) ICSA3 (ICSPA3) - BA1MS1M - A - 60AQL - 40AQL - 30BLNM - T1 - 5L - SC - SC



* Refer to page 51 for the details of model specification items.

Models/Specifications

* [] is for the high-precision specification.

Encoder Type	XY-axis configuration direction (*1)	Z-axis type (*2)	Model
Absolute	1	M	ICSA3 [ICSPA3] -BA1MS1M-A- <input type="checkbox"/> - <input type="checkbox"/> - <input type="checkbox"/> - <input type="checkbox"/> -BNM-T1- <input type="checkbox"/> - <input type="checkbox"/>
		L	ICSA3 [ICSPA3] -BA1MS1L-A- <input type="checkbox"/> - <input type="checkbox"/> - <input type="checkbox"/> - <input type="checkbox"/> -BNM-T1- <input type="checkbox"/> - <input type="checkbox"/>
	2	M	ICSA3 [ICSPA3] -BA2MS1M-A- <input type="checkbox"/> - <input type="checkbox"/> - <input type="checkbox"/> - <input type="checkbox"/> -BNM-T1- <input type="checkbox"/> - <input type="checkbox"/>
		L	ICSA3 [ICSPA3] -BA2MS1L-A- <input type="checkbox"/> - <input type="checkbox"/> - <input type="checkbox"/> - <input type="checkbox"/> -BNM-T1- <input type="checkbox"/> - <input type="checkbox"/>
	3	M	ICSA3 [ICSPA3] -BA3MS1M-A- <input type="checkbox"/> - <input type="checkbox"/> - <input type="checkbox"/> - <input type="checkbox"/> -BNM-T1- <input type="checkbox"/> - <input type="checkbox"/>
		L	ICSA3 [ICSPA3] -BA3MS1L-A- <input type="checkbox"/> - <input type="checkbox"/> - <input type="checkbox"/> - <input type="checkbox"/> -BNM-T1- <input type="checkbox"/> - <input type="checkbox"/>
	4	M	ICSA3 [ICSPA3] -BA4MS1M-A- <input type="checkbox"/> - <input type="checkbox"/> - <input type="checkbox"/> - <input type="checkbox"/> -BNM-T1- <input type="checkbox"/> - <input type="checkbox"/>
		L	ICSA3 [ICSPA3] -BA4MS1L-A- <input type="checkbox"/> - <input type="checkbox"/> - <input type="checkbox"/> - <input type="checkbox"/> -BNM-T1- <input type="checkbox"/> - <input type="checkbox"/>
Incremental	1	M	ICSA3 [ICSPA3] -BA1MS1M-I- <input type="checkbox"/> - <input type="checkbox"/> - <input type="checkbox"/> - <input type="checkbox"/> -BNM-T1- <input type="checkbox"/> - <input type="checkbox"/>
		L	ICSA3 [ICSPA3] -BA1MS1L-I- <input type="checkbox"/> - <input type="checkbox"/> - <input type="checkbox"/> - <input type="checkbox"/> -BNM-T1- <input type="checkbox"/> - <input type="checkbox"/>
	2	M	ICSA3 [ICSPA3] -BA2MS1M-I- <input type="checkbox"/> - <input type="checkbox"/> - <input type="checkbox"/> - <input type="checkbox"/> -BNM-T1- <input type="checkbox"/> - <input type="checkbox"/>
		L	ICSA3 [ICSPA3] -BA2MS1L-I- <input type="checkbox"/> - <input type="checkbox"/> - <input type="checkbox"/> - <input type="checkbox"/> -BNM-T1- <input type="checkbox"/> - <input type="checkbox"/>
	3	M	ICSA3 [ICSPA3] -BA3MS1M-I- <input type="checkbox"/> - <input type="checkbox"/> - <input type="checkbox"/> - <input type="checkbox"/> -BNM-T1- <input type="checkbox"/> - <input type="checkbox"/>
		L	ICSA3 [ICSPA3] -BA3MS1L-I- <input type="checkbox"/> - <input type="checkbox"/> - <input type="checkbox"/> - <input type="checkbox"/> -BNM-T1- <input type="checkbox"/> - <input type="checkbox"/>
	4	M	ICSA3 [ICSPA3] -BA4MS1M-I- <input type="checkbox"/> - <input type="checkbox"/> - <input type="checkbox"/> - <input type="checkbox"/> -BNM-T1- <input type="checkbox"/> - <input type="checkbox"/>
		L	ICSA3 [ICSPA3] -BA4MS1L-I- <input type="checkbox"/> - <input type="checkbox"/> - <input type="checkbox"/> - <input type="checkbox"/> -BNM-T1- <input type="checkbox"/> - <input type="checkbox"/>

*1: Refer to the figure below for XY-axis configuration direction.

*2: The load capacity and the maximum speed may vary depending on the type of Z-axis.
Note: T1 in the above models will be T2 when operated with XSEL-P/Q type.

Explanation of Model Code

Number	Contents	Specification
<input type="checkbox"/>	X-axis stroke (Note 1)	10 : 100mm ~ 60 : 600mm
<input type="checkbox"/>	Y-axis stroke (Note 1)	10 : 100mm ~ 40 : 400mm
<input type="checkbox"/>	Z-axis stroke (Note 1)	10 : 100mm ~ 30 : 300mm
<input type="checkbox"/>	Cable length (Note 2)	3L : 3m 5L : 5m
<input type="checkbox"/>	Y-axis/ Z-axis cable management	SC-SC : Self-standing cable

* The above explains the Models/Specifications chart to the left.

Options

Please add the option codes at the end of each stroke of the axis.
When adding multiple options, put together in alphabetic order.

Name	Code	Page
AQ seal	AQ	P13
Brake	B	P13
Creep sensor	C	P13
Home limit switch	L	P14
Reversed-home specification	NM	P14
Guide with ball-retaining mechanism	RT	P14

Configuration Direction

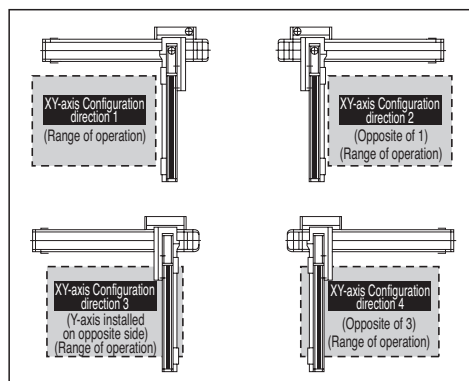

Common Specifications

* [] is for the high-precision specification.

Drive system	Ball screw, rolled C10 [equivalent to rolled C5]
Positioning repeatability	±0.02mm [±0.01mm]
Backlash	0.05mm or less [0.02mm or less]
Guide	Integrated with base
Base	Material: Aluminum with white alumite treatment
X-axis motor output / lead	60W / 8mm
Y-axis motor output / lead	60W / 8mm
Z-axis motor output / lead	60W / 8mm (M), 4mm (L)

Applicable Controller Specifications

Refer to page 65 for System Configuration.

Axis Configuration

* [] is for the high-precision specification.

Axis Type	Model	Page
X-axis	ISA[ISPA]-SXM- <input type="checkbox"/> -60-8-(Stroke)-T1	P15
Y-axis	ISA[ISPA]-SYM- <input type="checkbox"/> -60-8-(Stroke)-T1	P16
Z-axis	ISA[ISPA]-SZM- <input type="checkbox"/> -60-8/4-(Stroke)-T1-B-NM	P17

*In the above model name, indicates encoder type A (absolute) or I (incremental).



Caution

(Note 1) The stroke in the model is specified in cm (centimeters).
(Note 2) The cable length measures from the X-axis connector box to the controller. The standard lengths are 3m and 5m, but other lengths can also be specified in meters. The maximum length is 20m.
(Note 3) The rated acceleration is 0.3G. Increasing the acceleration will result in lower load capacity.
(Note 4) Please note that a longer stroke will result in a lower maximum speed.

* For other points to note, please refer to page 49.

ICSA3 [ICSPA3] -BA□MS1□

Load Capacity (kg) (Note3)

BA□MS1M

		Y-axis stroke			
		100	200	300	400
Z-axis stroke	100	3.0			
	200	2.3			
	300	1.6			

BA□MS1L

		Y-axis stroke			
		100	200	300	400
Z-axis stroke	100	11.0	7.6	3.6	
	200	10.3	6.9	2.9	
	300	9.6	6.2	2.2	

Maximum Speed by Stroke (mm/sec) (Note4)

BA□MS1M

	Stroke					
	100	200	300	400	500	600
X-axis	400					
Y-axis	400		-	-	-	-
Z-axis	400		-	-	-	-

BA□MS1L

	Stroke					
	100	200	300	400	500	600
X-axis	400					
Y-axis	400		-	-	-	-
Z-axis	200		-	-	-	-

Dimensions * The dimension below is for XY-axis Configuration direction 1.

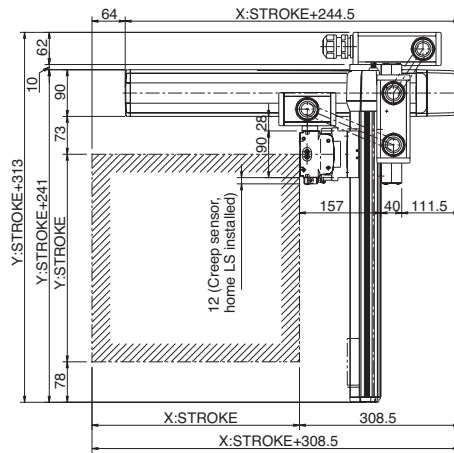
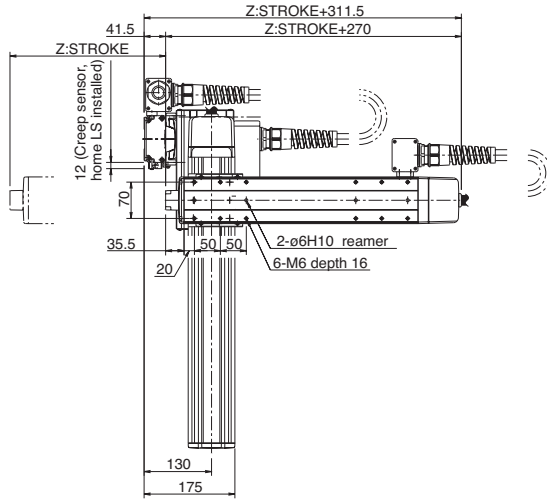

* The configuration position in the figure is home position. To change the home position, indicate NM in the option. Note that changing the home direction will require the actuator to be returned to IAI for adjustment.

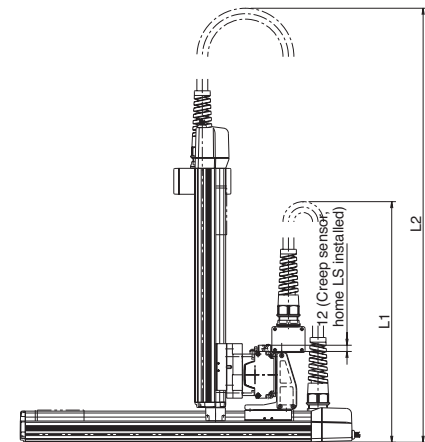

X stroke	100	200	300	400	500	600
L1	(500)	(550)	(600)	(650)	(700)	(750)
A	151	251	151	251	151	251
B	0	0	1	1	2	2
C	4	4	6	6	8	8

Z stroke	Y stroke			
	100	200	300	400
100	(610)	(660)	(710)	(760)
200	(710)	(750)	(810)	(860)
300	(810)	(860)	(910)	(960)



ICSA3-BB **HS1**

Cartesian Robot: X-Y-Z 3-Axes Configuration
Z-axis Slider Mount Type

ICSPA3-BB **HS1**

Cartesian Robot: X-Y-Z 3-Axes Configuration
Z-axis Slider Mount Type **High-Precision Specification**

Type XYB + Z-axis Slider Mount Type Stroke X-axis: 200-800mm Y-axis: 100-400mm Z-axis: 100-300mm Load capacity 7.2kg ~ 1.6kg

Model specification items Series Type Encoder type X-axis stroke + options Y-axis stroke + options Z-axis stroke + options Applicable controller Cable length Cable management
(Example) ICSA3 [ICSPA3] - BB1HS1M - A - 60AQL - 40AQL - 30BLM - T1 - 5L - SC - SC



* Refer to page 51 for the details of model specification items.

Models/Specifications * [] is for the high-precision specification.

Encoder Type	XY-axis configuration direction (*1)	Z-axis type (*2)	Model
Absolute	1	M	ICSA3 [ICSPA3] -BB1HS1M-A- <input type="checkbox"/> - <input type="checkbox"/> - <input type="checkbox"/> -BNM-T1- <input type="checkbox"/> - <input type="checkbox"/>
		L	ICSA3 [ICSPA3] -BB1HS1L-A- <input type="checkbox"/> - <input type="checkbox"/> - <input type="checkbox"/> -BNM-T1- <input type="checkbox"/> - <input type="checkbox"/>
	2	M	ICSA3 [ICSPA3] -BB2HS1M-A- <input type="checkbox"/> - <input type="checkbox"/> - <input type="checkbox"/> -BNM-T1- <input type="checkbox"/> - <input type="checkbox"/>
		L	ICSA3 [ICSPA3] -BB2HS1L-A- <input type="checkbox"/> - <input type="checkbox"/> - <input type="checkbox"/> -BNM-T1- <input type="checkbox"/> - <input type="checkbox"/>
	3	M	ICSA3 [ICSPA3] -BB3HS1M-A- <input type="checkbox"/> - <input type="checkbox"/> - <input type="checkbox"/> -BNM-T1- <input type="checkbox"/> - <input type="checkbox"/>
		L	ICSA3 [ICSPA3] -BB3HS1L-A- <input type="checkbox"/> - <input type="checkbox"/> - <input type="checkbox"/> -BNM-T1- <input type="checkbox"/> - <input type="checkbox"/>
	4	M	ICSA3 [ICSPA3] -BB4HS1M-A- <input type="checkbox"/> - <input type="checkbox"/> - <input type="checkbox"/> -BNM-T1- <input type="checkbox"/> - <input type="checkbox"/>
		L	ICSA3 [ICSPA3] -BB4HS1L-A- <input type="checkbox"/> - <input type="checkbox"/> - <input type="checkbox"/> -BNM-T1- <input type="checkbox"/> - <input type="checkbox"/>
Incremental	1	M	ICSA3 [ICSPA3] -BB1HS1M-I- <input type="checkbox"/> - <input type="checkbox"/> - <input type="checkbox"/> -BNM-T1- <input type="checkbox"/> - <input type="checkbox"/>
		L	ICSA3 [ICSPA3] -BB1HS1L-I- <input type="checkbox"/> - <input type="checkbox"/> - <input type="checkbox"/> -BNM-T1- <input type="checkbox"/> - <input type="checkbox"/>
	2	M	ICSA3 [ICSPA3] -BB2HS1M-I- <input type="checkbox"/> - <input type="checkbox"/> - <input type="checkbox"/> -BNM-T1- <input type="checkbox"/> - <input type="checkbox"/>
		L	ICSA3 [ICSPA3] -BB2HS1L-I- <input type="checkbox"/> - <input type="checkbox"/> - <input type="checkbox"/> -BNM-T1- <input type="checkbox"/> - <input type="checkbox"/>
	3	M	ICSA3 [ICSPA3] -BB3HS1M-I- <input type="checkbox"/> - <input type="checkbox"/> - <input type="checkbox"/> -BNM-T1- <input type="checkbox"/> - <input type="checkbox"/>
		L	ICSA3 [ICSPA3] -BB3HS1L-I- <input type="checkbox"/> - <input type="checkbox"/> - <input type="checkbox"/> -BNM-T1- <input type="checkbox"/> - <input type="checkbox"/>
	4	M	ICSA3 [ICSPA3] -BB4HS1M-I- <input type="checkbox"/> - <input type="checkbox"/> - <input type="checkbox"/> -BNM-T1- <input type="checkbox"/> - <input type="checkbox"/>
		L	ICSA3 [ICSPA3] -BB4HS1L-I- <input type="checkbox"/> - <input type="checkbox"/> - <input type="checkbox"/> -BNM-T1- <input type="checkbox"/> - <input type="checkbox"/>

*1: Refer to the figure below for XY-axis configuration direction.
*2: The load capacity and the maximum speed may vary depending on the type of Z-axis.
Note: T1 in the above models will be T2 when operated with XSEL-P/Q type.

Explanation of Model Code

Number	Contents	Specification
<input type="checkbox"/>	X-axis stroke (Note 1)	20 : 80mm ~ 80 : 800mm
<input type="checkbox"/>	Y-axis stroke (Note 1)	10 : 100mm ~ 40 : 400mm
<input type="checkbox"/>	Z-axis stroke (Note 1)	10 : 100mm ~ 30 : 300mm
<input type="checkbox"/>	Cable length (Note 2)	3L : 3m 5L : 5m
<input type="checkbox"/>	Y-axis/ Z-axis cable management	SC-SC : Self-standing cable

* The above explains the Models/Specifications chart to the left.

Options

Please add the option codes at the end of each stroke of the axis. When adding multiple options, put together in alphabetic order.

Name	Code	Page
AQ seal	AQ	P13
Brake	B	P13
Creep sensor	C	P13
Home limit switch	L	P14
Reversed-home specification	NM	P14
Guide with ball-retaining mechanism	RT	P14

Configuration Direction

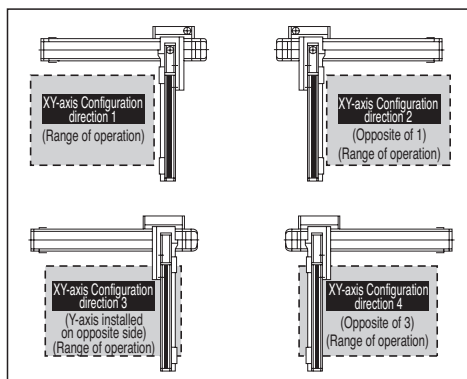

Common Specifications * [] is for the high-precision specification.

Drive system	Ball screw, rolled C10 [equivalent to rolled C5]
Positioning repeatability	±0.02mm [±0.01mm]
Backlash	0.05mm or less [0.02mm or less]
Guide	Integrated with base
Base	Material: Aluminum with white alumite treatment
X-axis motor output / lead	100W / 20mm
Y-axis motor output / lead	60W / 16mm
Z-axis motor output / lead	60W / 8mm (M), 4mm (L)

Applicable Controller Specifications

Refer to page 65 for System Configuration.

Axis Configuration * [] is for the high-precision specification.

Axis Type	Model	Page
X-axis	ISA[ISPA]-MXM- <input type="checkbox"/> -100-20-(Stroke)-T1	P18
Y-axis	ISA[ISPA]-SYM- <input type="checkbox"/> -60-16-(Stroke)-T1	P16
Z-axis	ISA[ISPA]-SZM- <input type="checkbox"/> -60-8/4-(Stroke)-T1-B-NM	P17

*In the above model name, indicates encoder type A (absolute) or I (incremental).



Caution

(Note 1) The stroke in the model is specified in cm (centimeters).
(Note 2) The cable length measures from the X-axis connector box to the controller. The standard lengths are 3m and 5m, but other lengths can also be specified in meters. The maximum length is 20m.
(Note 3) The rated acceleration is 0.3G. Increasing the acceleration will result in lower load capacity.
(Note 4) Please note that a longer stroke will result in a lower maximum speed.

* For other points to note, please refer to page 49.

ICSA3 [ICSPA3] -BB□HS1□

Single-Axis Robots
Cartesian Robots

Load Capacity (kg) (Note3)

BB□HS1M

		Y-axis stroke			
		100	200	300	400
Z-axis stroke	100	3.0			
	200	2.3			
	300	1.6			

BB□HS1L

		Y-axis stroke			
		100	200	300	400
Z-axis stroke	100	7.2	7.0	6.3	
	200	6.5	6.3	5.6	
	300	5.8	5.6	4.9	

Maximum Speed by Stroke (mm/sec) (Note4)

BB□HS1M

	Stroke								
	100	200	300	400	500	600	700	800	
X-axis	1000							795	
Y-axis	800								
Z-axis	400								

BB□HS1L

	Stroke								
	100	200	300	400	500	600	700	800	
X-axis	1000							795	
Y-axis	800								
Z-axis	200								

Dimensions

* The dimension below is for XY-axis Configuration direction 1.

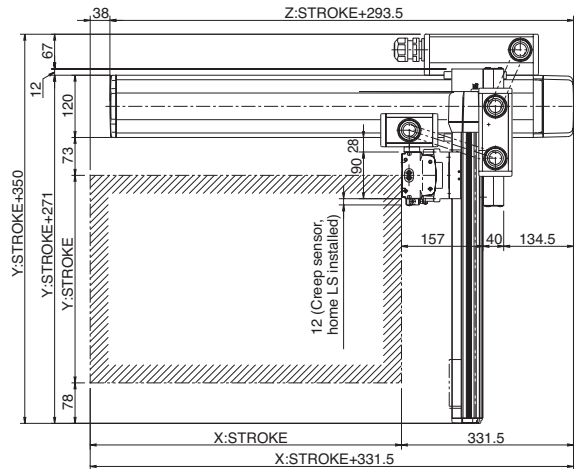
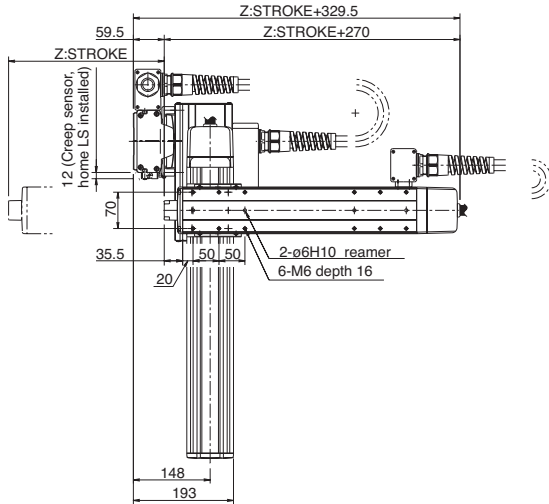

* The configuration position in the figure is home position. To change the home position, indicate NM in the option. Note that changing the home direction will require the actuator to be returned to IA1 for adjustment.

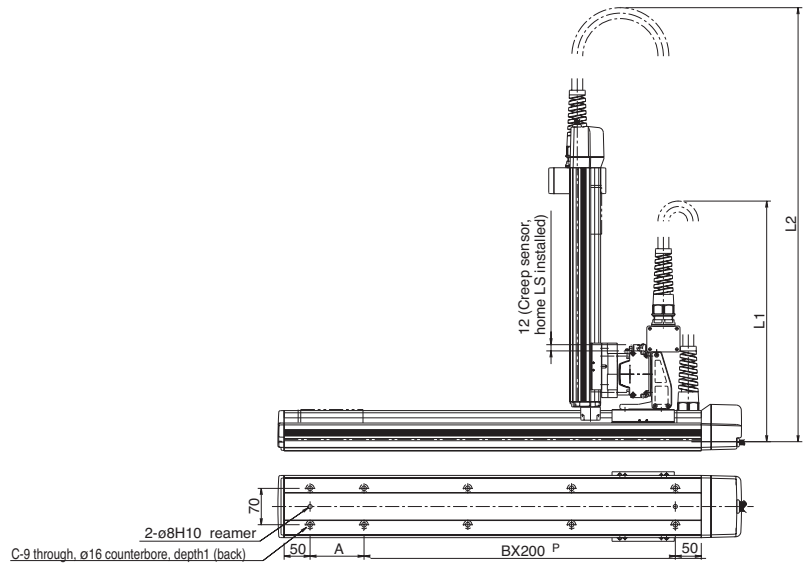

X stroke	200	300	400	500	600	700	800
L1	(550)	(600)	(650)	(700)	(750)	(800)	(850)
A	104	204	104	204	104	204	104
B	1	1	2	2	3	3	4
C	6	6	8	8	10	10	12

Z stroke	Y stroke			
	100	200	300	400
100	(630)	(680)	(730)	(780)
200	(730)	(780)	(830)	(880)
300	(830)	(880)	(930)	(980)

ICSA3-BB **MS1** Cartesian Robot: X-Y-Z 3-Axes Configuration
Z-Axis Slider Mount Type

ICSPA3-BB **MS1** Cartesian Robot: X-Y-Z 3-Axes Configuration
Z-Axis Slider Mount Type **High-Precision Specification**

Type XYB + Z-Axis Slider Mount Type **Stroke** X-axis: 200-800mm Y-axis: 100-400mm Z-axis: 100-300mm **Load capacity** 11kg ~ 1.6kg

Model specification items Series - Type - Encoder type - X-axis stroke + options - Y-axis stroke + options - Z-axis stroke + options - Applicable controller - Cable length - Cable management
(Example) ICSA3 (ICSPA3) - BB1MS1M - A - 60AQL - 40AQL - 30BLNM - T1 - 5L - SC - SC



* Refer to page 51 for the details of model specification items.

Models/Specifications * [] is for the high-precision specification.

Encoder Type	XY-axis configuration direction (*1)	Z-axis type (*2)	Model
Absolute	1	M	ICSA3 [ICSPA3] -BB1MS1M-A- <input type="checkbox"/> - <input type="checkbox"/> - <input type="checkbox"/> -BNM-T1- <input type="checkbox"/> - <input type="checkbox"/>
		L	ICSA3 [ICSPA3] -BB1MS1L-A- <input type="checkbox"/> - <input type="checkbox"/> - <input type="checkbox"/> -BNM-T1- <input type="checkbox"/> - <input type="checkbox"/>
	2	M	ICSA3 [ICSPA3] -BB2MS1M-A- <input type="checkbox"/> - <input type="checkbox"/> - <input type="checkbox"/> -BNM-T1- <input type="checkbox"/> - <input type="checkbox"/>
		L	ICSA3 [ICSPA3] -BB2MS1L-A- <input type="checkbox"/> - <input type="checkbox"/> - <input type="checkbox"/> -BNM-T1- <input type="checkbox"/> - <input type="checkbox"/>
	3	M	ICSA3 [ICSPA3] -BB3MS1M-A- <input type="checkbox"/> - <input type="checkbox"/> - <input type="checkbox"/> -BNM-T1- <input type="checkbox"/> - <input type="checkbox"/>
		L	ICSA3 [ICSPA3] -BB3MS1L-A- <input type="checkbox"/> - <input type="checkbox"/> - <input type="checkbox"/> -BNM-T1- <input type="checkbox"/> - <input type="checkbox"/>
	4	M	ICSA3 [ICSPA3] -BB4MS1M-A- <input type="checkbox"/> - <input type="checkbox"/> - <input type="checkbox"/> -BNM-T1- <input type="checkbox"/> - <input type="checkbox"/>
		L	ICSA3 [ICSPA3] -BB4MS1L-A- <input type="checkbox"/> - <input type="checkbox"/> - <input type="checkbox"/> -BNM-T1- <input type="checkbox"/> - <input type="checkbox"/>
Incremental	1	M	ICSA3 [ICSPA3] -BB1MS1M-I- <input type="checkbox"/> - <input type="checkbox"/> - <input type="checkbox"/> -BNM-T1- <input type="checkbox"/> - <input type="checkbox"/>
		L	ICSA3 [ICSPA3] -BB1MS1L-I- <input type="checkbox"/> - <input type="checkbox"/> - <input type="checkbox"/> -BNM-T1- <input type="checkbox"/> - <input type="checkbox"/>
	2	M	ICSA3 [ICSPA3] -BB2MS1M-I- <input type="checkbox"/> - <input type="checkbox"/> - <input type="checkbox"/> -BNM-T1- <input type="checkbox"/> - <input type="checkbox"/>
		L	ICSA3 [ICSPA3] -BB2MS1L-I- <input type="checkbox"/> - <input type="checkbox"/> - <input type="checkbox"/> -BNM-T1- <input type="checkbox"/> - <input type="checkbox"/>
	3	M	ICSA3 [ICSPA3] -BB3MS1M-I- <input type="checkbox"/> - <input type="checkbox"/> - <input type="checkbox"/> -BNM-T1- <input type="checkbox"/> - <input type="checkbox"/>
		L	ICSA3 [ICSPA3] -BB3MS1L-I- <input type="checkbox"/> - <input type="checkbox"/> - <input type="checkbox"/> -BNM-T1- <input type="checkbox"/> - <input type="checkbox"/>
	4	M	ICSA3 [ICSPA3] -BB4MS1M-I- <input type="checkbox"/> - <input type="checkbox"/> - <input type="checkbox"/> -BNM-T1- <input type="checkbox"/> - <input type="checkbox"/>
		L	ICSA3 [ICSPA3] -BB4MS1L-I- <input type="checkbox"/> - <input type="checkbox"/> - <input type="checkbox"/> -BNM-T1- <input type="checkbox"/> - <input type="checkbox"/>

*1: Refer to the figure below for XY-axis configuration direction.
*2: The load capacity and the maximum speed may vary depending on the type of Z-axis.
Note: T1 in the above models will be T2 when operated with XSEL-P/Q type.

Explanation of Model Code

Number	Contents	Specification
<input type="checkbox"/>	X-axis stroke (Note 1)	20 : 200mm ~ 80 : 800mm
<input type="checkbox"/>	Y-axis stroke (Note 1)	10 : 100mm ~ 40 : 400mm
<input type="checkbox"/>	Z-axis stroke (Note 1)	10 : 100mm ~ 30 : 300mm
<input type="checkbox"/>	Cable length (Note 2)	3L : 3m 5L : 5m
<input type="checkbox"/>	Y-axis/ Z-axis cable management	SC-SC : Self-standing cable

* The above explains the Models/Specifications chart to the left.

Options

Please add the option codes at the end of each stroke of the axis.
When adding multiple options, put together in alphabetic order.

Name	Code	Page
AQ seal	AQ	P13
Brake	B	P13
Creep sensor	C	P13
Home limit switch	L	P14
Reversed-home specification	NM	P14
Guide with ball-retaining mechanism	RT	P14

Configuration Direction

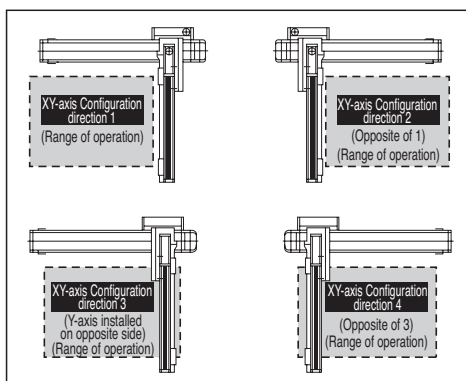

Common Specifications * [] is for the high-precision specification.

Drive system	Ball screw, rolled C10 [equivalent to rolled C5]
Positioning repeatability	±0.02mm [±0.01mm]
Backlash	0.05mm or less [0.02mm or less]
Guide	Integrated with base
Base	Material: Aluminum with white alumite treatment
X-axis motor output / lead	100W / 10mm
Y-axis motor output / lead	60W / 8mm
Z-axis motor output / lead	60W / 8mm (M), 4mm (L)

Applicable Controller Specifications

Refer to page 65 for System Configuration.

Axis Configuration * [] is for the high-precision specification.

Axis Type	Model	Page
X-axis	ISA[ISPA]-MXM- <input type="checkbox"/> -100-10-(Stroke)-T1	P18
Y-axis	ISA[ISPA]-SYM- <input type="checkbox"/> -60-8-(Stroke)-T1	P16
Z-axis	ISA[ISPA]-SZM- <input type="checkbox"/> -60-8/4-(Stroke)-T1-B-NM	P17

*In the above model name, indicates encoder type A (absolute) or I (incremental).



Caution

(Note 1) The stroke in the model is specified in cm (centimeters).
(Note 2) The cable length measures from the X-axis connector box to the controller. The standard lengths are 3m and 5m, but other lengths can also be specified in meters. The maximum length is 20m.
(Note 3) The rated acceleration is 0.3G. Increasing the acceleration will result in lower load capacity.
(Note 4) Please note that a longer stroke will result in a lower maximum speed.

* For other points to note, please refer to page 49.

ICSA3 [ICSPA3] -BB□MS1□

Load Capacity (kg) (Note3)

BB□MS1M

		Y-axis stroke			
		100	200	300	400
Z-axis stroke	100	3.0			
	200	2.3			
	300	1.6			

BB□MS1L

		Y-axis stroke			
		100	200	300	400
Z-axis stroke	100	11.0			
	200	10.3			
	300	9.6			

Maximum Speed by Stroke (mm/sec) (Note4)

BB□MS1M

	Stroke								
	100	200	300	400	500	600	700	800	
X-axis	-	500						480	380
Y-axis	400				-	-	-	-	
Z-axis	400		-	-	-	-	-	-	

BB□MS1L

	Stroke								
	100	200	300	400	500	600	700	800	
X-axis	-	500						480	380
Y-axis	400				-	-	-	-	
Z-axis	200		-	-	-	-	-	-	

Dimensions

* The dimension below is for XY-axis Configuration direction 1.

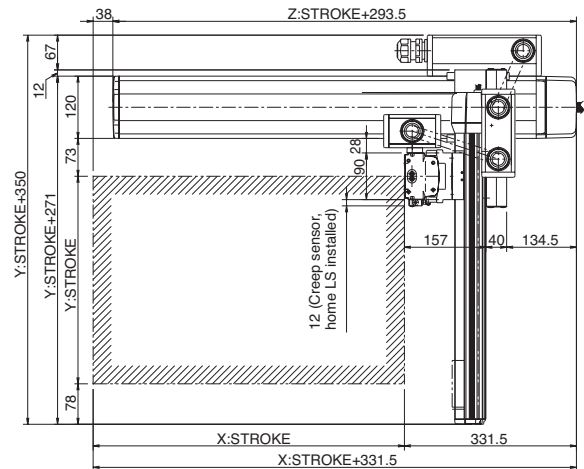
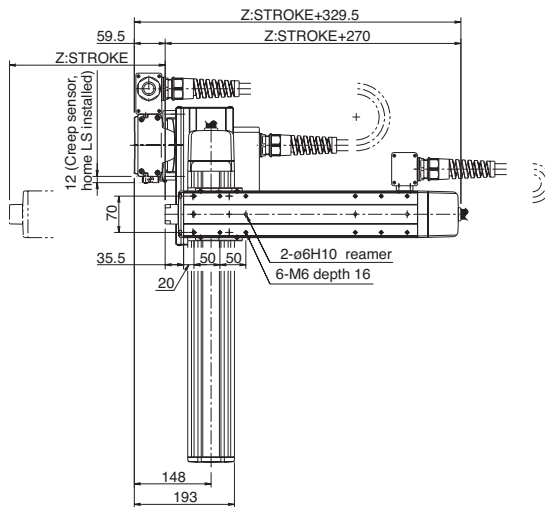

* The configuration position in the figure is home position. To change the home position, indicate NM in the option. Note that changing the home direction will require the actuator to be returned to IAI for adjustment.

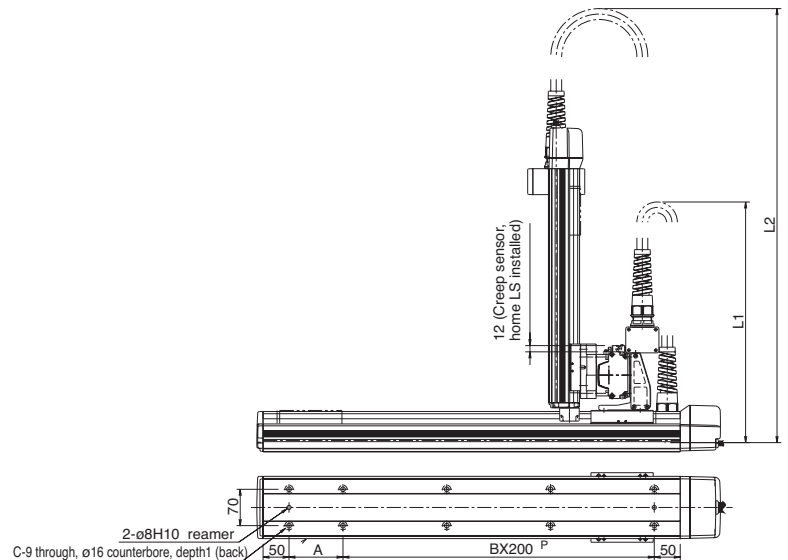

X stroke	200	300	400	500	600	700	800
L1	(550)	(600)	(650)	(700)	(750)	(800)	(850)
A	104	204	104	204	104	204	104
B	1	1	2	2	3	3	4
C	6	6	8	8	10	10	12

		Y stroke			
		100	200	300	400
Z stroke	100	(630)	(680)	(730)	(780)
	200	(730)	(780)	(830)	(880)
	300	(830)	(880)	(930)	(980)

ICSA3-BC **HS1**

Cartesian Robot: X-Y-Z 3-Axes Configuration
Z-axis Slider Mount Type

ICSPA3-BC **HS1**

Cartesian Robot: X-Y-Z 3-Axes Configuration
Z-axis Slied Mount Type **High-Precision Specification**

Type XYB + Z-axis Slider Mount Type Stroke X-axis: 200-800mm Y-axis: 100-500mm Z-axis: 100-300mm Load capacity 10kg ~ 1.6kg

Model specification items Series - Type - Encoder type - X-axis stroke + options - Y-axis stroke + options - Z-axis stroke + options - Applicable controller - Cable length - Cable management
(Example) ICSA3 (ICSPA3) - BC1HS1M - A - 70AQL - 40AQL - 30BLNM - T1 - 5L - SC-SC



* Refer to page 51 for the details of model specification items.

Models/Specifications * [] is for the high-precision specification.

Encoder Type	XY-axis configuration direction (*1)	Z-axis type (*2)	Model
Absolute	1	M	ICSA3 [ICSPA3] -BC1HS1M-A- <input type="checkbox"/> - <input type="checkbox"/> - <input type="checkbox"/> -BNM-T1- <input type="checkbox"/> - <input type="checkbox"/>
		L	ICSA3 [ICSPA3] -BC1HS1L-A- <input type="checkbox"/> - <input type="checkbox"/> - <input type="checkbox"/> -BNM-T1- <input type="checkbox"/> - <input type="checkbox"/>
	2	M	ICSA3 [ICSPA3] -BC2HS1M-A- <input type="checkbox"/> - <input type="checkbox"/> - <input type="checkbox"/> -BNM-T1- <input type="checkbox"/> - <input type="checkbox"/>
		L	ICSA3 [ICSPA3] -BC2HS1L-A- <input type="checkbox"/> - <input type="checkbox"/> - <input type="checkbox"/> -BNM-T1- <input type="checkbox"/> - <input type="checkbox"/>
	3	M	ICSA3 [ICSPA3] -BC3HS1M-A- <input type="checkbox"/> - <input type="checkbox"/> - <input type="checkbox"/> -BNM-T1- <input type="checkbox"/> - <input type="checkbox"/>
		L	ICSA3 [ICSPA3] -BC3HS1L-A- <input type="checkbox"/> - <input type="checkbox"/> - <input type="checkbox"/> -BNM-T1- <input type="checkbox"/> - <input type="checkbox"/>
	4	M	ICSA3 [ICSPA3] -BC4HS1M-A- <input type="checkbox"/> - <input type="checkbox"/> - <input type="checkbox"/> -BNM-T1- <input type="checkbox"/> - <input type="checkbox"/>
		L	ICSA3 [ICSPA3] -BC4HS1L-A- <input type="checkbox"/> - <input type="checkbox"/> - <input type="checkbox"/> -BNM-T1- <input type="checkbox"/> - <input type="checkbox"/>
Incremental	1	M	ICSA3 [ICSPA3] -BC1HS1M-I- <input type="checkbox"/> - <input type="checkbox"/> - <input type="checkbox"/> -BNM-T1- <input type="checkbox"/> - <input type="checkbox"/>
		L	ICSA3 [ICSPA3] -BC1HS1L-I- <input type="checkbox"/> - <input type="checkbox"/> - <input type="checkbox"/> -BNM-T1- <input type="checkbox"/> - <input type="checkbox"/>
	2	M	ICSA3 [ICSPA3] -BC2HS1M-I- <input type="checkbox"/> - <input type="checkbox"/> - <input type="checkbox"/> -BNM-T1- <input type="checkbox"/> - <input type="checkbox"/>
		L	ICSA3 [ICSPA3] -BC2HS1L-I- <input type="checkbox"/> - <input type="checkbox"/> - <input type="checkbox"/> -BNM-T1- <input type="checkbox"/> - <input type="checkbox"/>
	3	M	ICSA3 [ICSPA3] -BC3HS1M-I- <input type="checkbox"/> - <input type="checkbox"/> - <input type="checkbox"/> -BNM-T1- <input type="checkbox"/> - <input type="checkbox"/>
		L	ICSA3 [ICSPA3] -BC3HS1L-I- <input type="checkbox"/> - <input type="checkbox"/> - <input type="checkbox"/> -BNM-T1- <input type="checkbox"/> - <input type="checkbox"/>
	4	M	ICSA3 [ICSPA3] -BC4HS1M-I- <input type="checkbox"/> - <input type="checkbox"/> - <input type="checkbox"/> -BNM-T1- <input type="checkbox"/> - <input type="checkbox"/>
		L	ICSA3 [ICSPA3] -BC4HS1L-I- <input type="checkbox"/> - <input type="checkbox"/> - <input type="checkbox"/> -BNM-T1- <input type="checkbox"/> - <input type="checkbox"/>

*1: Refer to the figure below for XY-axis configuration direction.
*2: The load capacity and the maximum speed may vary depending on the type of Z-axis.
Note: T1 in the above models will be T2 when operated with XSEL-P/Q type.

Explanation of Model Code

Number	Contents	Specification
<input type="checkbox"/>	X-axis stroke (Note 1)	20 : 80mm ~ 80 : 800mm
<input type="checkbox"/>	Y-axis stroke (Note 1)	10 : 100mm ~ 50 : 500mm
<input type="checkbox"/>	Z-axis stroke (Note 1)	10 : 100mm ~ 30 : 300mm
<input type="checkbox"/>	Cable length (Note 2)	3L : 3m 5L : 5m
<input type="checkbox"/>	Y-axis/ Z-axis cable management	SC-SC : Self-standing cable

* The above explains the Models/Specifications chart to the left.

Options

Please add the option codes at the end of each stroke of the axis.
When adding multiple options, put together in alphabetic order.

Name	Code	Page
AQ seal	AQ	P13
Brake	B	P13
Creep sensor	C	P13
Home limit switch	L	P14
Reversed-home specification	NM	P14
Guide with ball-retaining mechanism	RT	P14

Configuration Direction

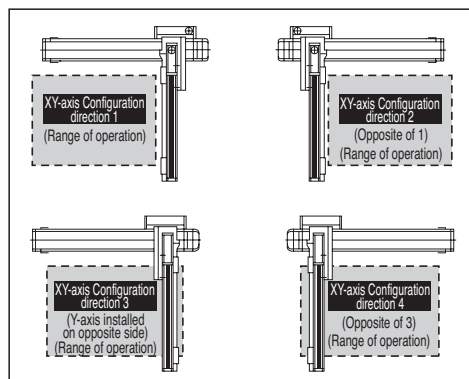

Common Specifications * [] is for the high-precision specification.

Drive system	Ball screw, rolled C10 [equivalent to rolled C5]
Positioning repeatability	±0.02mm [±0.01mm]
Backlash	0.05mm or less [0.02mm or less]
Guide	Integrated with base
Base	Material: Aluminum with white alumite treatment
X-axis motor output / lead	200W / 20mm
Y-axis motor output / lead	100W / 20mm
Z-axis motor output / lead	60W / 8mm (M), 4mm (L)

Applicable Controller Specifications

Refer to page 65 for System Configuration.

Axis Configuration * [] is for the high-precision specification.

Axis Type	Model	Page
X-axis	ISA[ISPA]-MXM- <input type="checkbox"/> -200-20-(Stroke)-T1	P19
Y-axis	ISA[ISPA]-MYM- <input type="checkbox"/> -100-20-(Stroke)-T1	P21
Z-axis	ISA[ISPA]-SZM- <input type="checkbox"/> -60-8/4-(Stroke)-T1-B-NM	P17

* In the above model name, indicates encoder type A (absolute) or I (incremental).



Caution

(Note 1) The stroke in the model is specified in cm (centimeters).
(Note 2) The cable length measures from the X-axis connector box to the controller. The standard lengths are 3m and 5m, but other lengths can also be specified in meters. The maximum length is 20m.
(Note 3) The rated acceleration is 0.3G. Increasing the acceleration will result in lower load capacity.
(Note 4) Please note that a longer stroke will result in a lower maximum speed.

* For other points to note, please refer to page 49.

ICSA3 [ICSPA3] -BC□HS1□

Load Capacity (kg) (Note3)

BC□HS1M

		Y-axis stroke			
		100	200	300	400
Z-axis stroke	100	3.0			
	200	2.3			
	300	1.6			

BC□HS1L

		Y-axis stroke			
		100	200	300	400
Z-axis stroke	100	11.0			
	200	10.3			
	300	9.6			

Maximum Speed by Stroke (mm/sec) (Note4)

BC□HS1M

	Stroke								
	100	200	300	400	500	600	700	800	
X-axis	-	1000							795
Y-axis	1000								-
Z-axis	400		-	-	-	-	-	-	

BC□HS1L

	Stroke								
	100	200	300	400	500	600	700	800	
X-axis	-	1000							795
Y-axis	1000								-
Z-axis	200		-	-	-	-	-	-	

Dimensions

* The dimension below is for XY-axis Configuration direction 1.

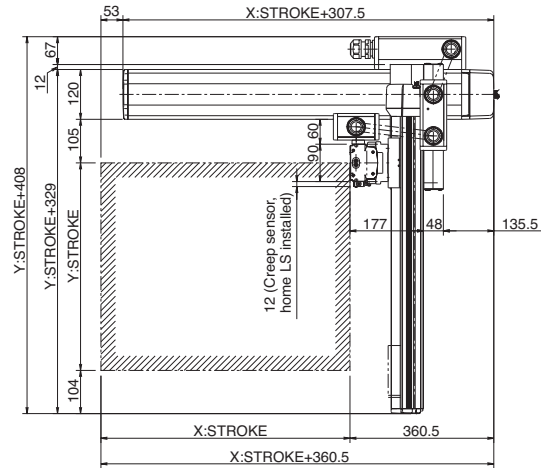
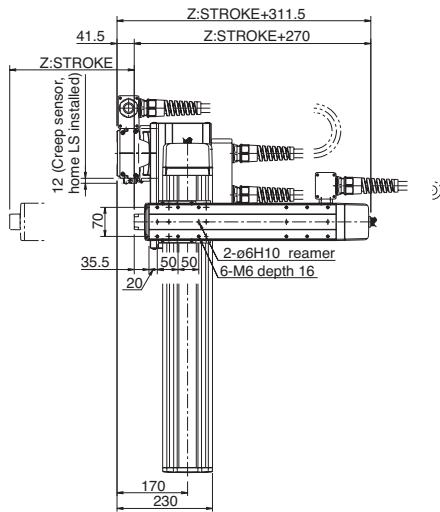

* The configuration position in the figure is home position. To change the home position, indicate NM in the option. Note that changing the home direction will require the actuator to be returned to IAI for adjustment.

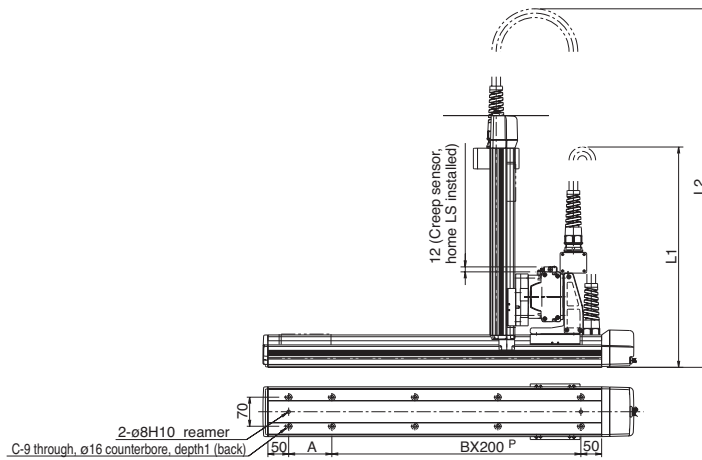

X stroke	200	300	400	500	600	700	800
L1	(550)	(600)	(650)	(700)	(750)	(800)	(850)
A	104	204	104	204	104	204	104
B	1	1	2	2	3	3	4
C	6	6	8	8	10	10	12

		Y stroke				
		100	200	300	400	500
Z stroke	100	(630)	(680)	(730)	(780)	(830)
	200	(730)	(780)	(830)	(880)	(930)
	300	(830)	(880)	(930)	(980)	(1030)

ICSA3-BC HS3M

Cartesian Robot: X-Y-Z 3-Axes Configuration
Z-Axis Slider Mount Type

ICSPA3-BC HS3M

Cartesian Robot: X-Y-Z 3-Axes Configuration
Z-Axis Slider Mount Type **High-Precision Specification**

Type XYB + Z-axis Slider Mount Type **Stroke** X-axis: 200-800mm Y-axis: 100-500mm Z-axis: 100-300mm **Load capacity** 10kg ~ 6.7kg

Model specification items (Example) ICSA3 [ICSPA3] - BC1HS3M - A - 70AQL - 40AQL - 30BLNM - T1 - 5L - SC - SC



* Refer to page 51 for the details of model specification items.

Models/Specifications

* [] is for the high-precision specification.

Encoder Type	XY-axis configuration direction (*1)	Z-axis type (*2)	Model
Absolute	1	M	ICSA3 [ICSPA3] -BC1HS3M-A- <input type="checkbox"/> - <input type="checkbox"/> - <input type="checkbox"/> -BNM-T1- <input type="checkbox"/> - <input type="checkbox"/>
	2	M	ICSA3 [ICSPA3] -BC2HS3M-A- <input type="checkbox"/> - <input type="checkbox"/> - <input type="checkbox"/> -BNM-T1- <input type="checkbox"/> - <input type="checkbox"/>
	3	M	ICSA3 [ICSPA3] -BC3HS3M-A- <input type="checkbox"/> - <input type="checkbox"/> - <input type="checkbox"/> -BNM-T1- <input type="checkbox"/> - <input type="checkbox"/>
	4	M	ICSA3 [ICSPA3] -BC4HS3M-A- <input type="checkbox"/> - <input type="checkbox"/> - <input type="checkbox"/> -BNM-T1- <input type="checkbox"/> - <input type="checkbox"/>
Incremental	1	M	ICSA3 [ICSPA3] -BC1HS3M-I- <input type="checkbox"/> - <input type="checkbox"/> - <input type="checkbox"/> -BNM-T1- <input type="checkbox"/> - <input type="checkbox"/>
	2	M	ICSA3 [ICSPA3] -BC2HS3M-I- <input type="checkbox"/> - <input type="checkbox"/> - <input type="checkbox"/> -BNM-T1- <input type="checkbox"/> - <input type="checkbox"/>
	3	M	ICSA3 [ICSPA3] -BC3HS3M-I- <input type="checkbox"/> - <input type="checkbox"/> - <input type="checkbox"/> -BNM-T1- <input type="checkbox"/> - <input type="checkbox"/>
	4	M	ICSA3 [ICSPA3] -BC4HS3M-I- <input type="checkbox"/> - <input type="checkbox"/> - <input type="checkbox"/> -BNM-T1- <input type="checkbox"/> - <input type="checkbox"/>

*1: Refer to the figure below for XY-axis configuration direction.

*2: The load capacity and the maximum speed may vary depending on the type of Z-axis.

Note: T1 in the above models will be T2 when operated with XSEL-P/Q type.

Explanation of Model Code

Number	Contents	Specification
<input type="checkbox"/>	X-axis stroke (Note 1)	20 : 80mm ~ 80 : 800mm
<input type="checkbox"/>	Y-axis stroke (Note 1)	10 : 100mm ~ 50 : 500mm
<input type="checkbox"/>	Z-axis stroke (Note 1)	10 : 100mm ~ 30 : 300mm
<input type="checkbox"/>	Cable length (Note 2)	3L : 3m 5L : 5m
<input type="checkbox"/>	Y-axis/ Z-axis cable management	SC-SC : Self-standing cable

* The above explains the Models/Specifications chart to the left.

Options

Please add the option codes at the end of each stroke of the axis. When adding multiple options, put together in alphabetic order.

Name	Code	Page
AQ seal	AQ	P13
Brake	B	P13
Creep sensor	C	P13
Home limit switch	L	P14
Reversed-home specification	NM	P14
Guide with ball-retaining mechanism	RT	P14

Configuration Direction

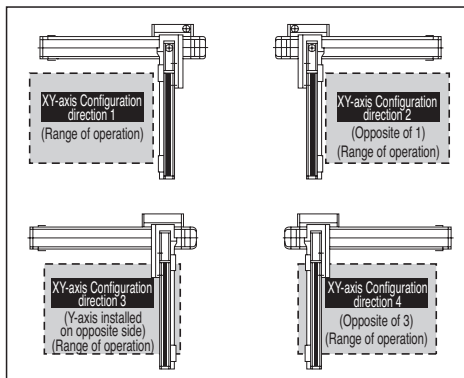

Common Specifications

* [] is for the high-precision specification.

Drive system	Ball screw, rolled C10 [equivalent to rolled C5]
Positioning repeatability	±0.02mm [±0.01mm]
Backlash	0.05mm or less [0.02mm or less]
Guide	Integrated with base
Base	Material: Aluminum with white alumite treatment
X-axis motor output / lead	200W / 20mm
Y-axis motor output / lead	100W / 20mm
Z-axis motor output / lead	200W / 10mm

Applicable Controller Specifications

Refer to page 65 for System Configuration.

Axis Configuration

* [] is for the high-precision specification.

Axis Type	Model	Page
X-axis	ISA[ISPA]-MXM- <input type="checkbox"/> -200-20-(Stroke)-T1	P19
Y-axis	ISA[ISPA]-MYM- <input type="checkbox"/> -100-20-(Stroke)-T1	P21
Z-axis	ISA[ISPA]-MZM- <input type="checkbox"/> -200-10-(Stroke)-T1-B-NM	P24

*In the above model name, indicates encoder type A (absolute) or I (incremental).



Caution

(Note 1) The stroke in the model is specified in cm (centimeters).
(Note 2) The cable length measures from the X-axis connector box to the controller. The standard lengths are 3m and 5m, but other lengths can also be specified in meters. The maximum length is 20m.
(Note 3) The rated acceleration is 0.3G. Increasing the acceleration will result in lower load capacity.
(Note 4) Please note that a longer stroke will result in a lower maximum speed.

* For other points to note, please refer to page 49.

ICSA3 [ICSPA3] -BC□HS3M

Single-Axis Robots
Cartesian Robots

Load Capacity (kg) (Note3)

BC□HS3M

		Y-axis stroke				
		100	200	300	400	500
Z-axis stroke	100	10.0			8.7	
	200	9.0			7.7	
	300	8.0			6.7	

Maximum Speed by Stroke (mm/sec) (Note4)

BC□HS3M

	Stroke								
	100	200	300	400	500	600	700	800	
X-axis	-	1000						795	
Y-axis	1000			-	-	-	-	-	-
Z-axis	500		-	-	-	-	-	-	-

Dimensions * The dimension below is for XY-axis Configuration direction 1.

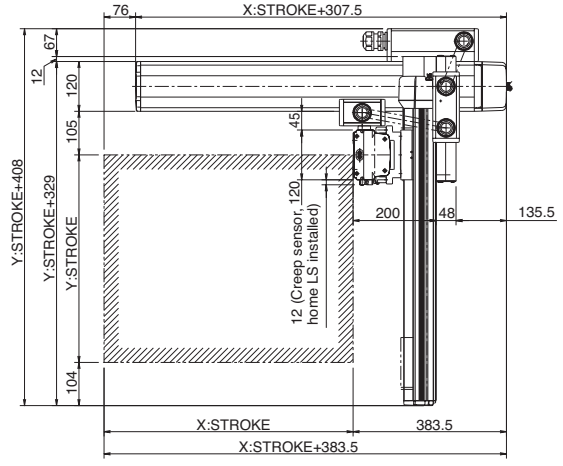
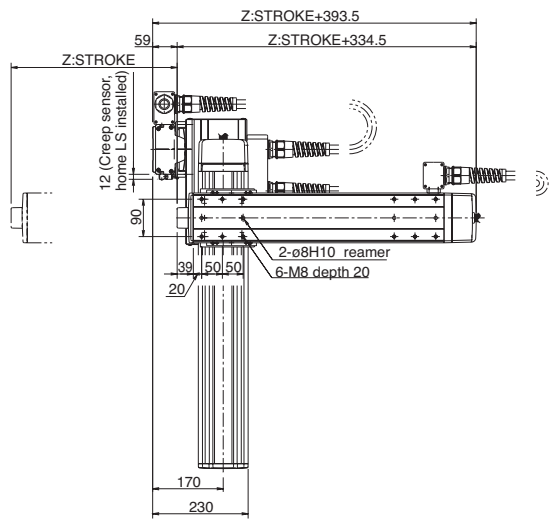

* The configuration position in the figure is home position. To change the home position, indicate NM in the option. Note that changing the home direction will require the actuator to be returned to IAI for adjustment.

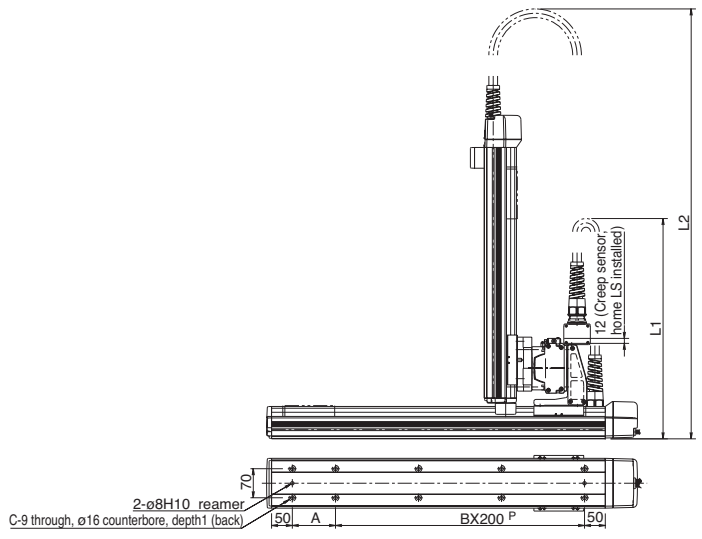

X stroke	200	300	400	500	600	700	800
L1	(550)	(600)	(650)	(700)	(750)	(800)	(850)
A	104	204	104	204	104	204	104
B	1	1	2	2	3	3	4
C	6	6	8	8	10	10	12

		Y stroke				
		100	200	300	400	500
Z stroke	100	(670)	(720)	(770)	(820)	(870)
	200	(770)	(820)	(870)	(920)	(970)
	300	(870)	(920)	(970)	(1020)	(1070)
	400	(970)	(1020)	(1070)	(1120)	(1170)

ICSA3-BC **MS1**

Cartesian Robot: X-Y-Z 3-Axes Configuration
Z-axis Slider Mount Type

ICSPA3-BC **MS1**

Cartesian Robot: X-Y-Z 3-Axes Configuration
Z-axis Slider Mount Type **High-Precision Specification**

Type XYB + Z-axis Slider Mount Type Stroke X-axis: 200-800mm Y-axis: 100-500mm Z-axis: 100-300mm Load capacity 11kg ~ 1.6kg

Model specification items Series Type Encoder type X-axis stroke + options Y-axis stroke + options Z-axis stroke + options Applicable controller Cable length Cable management
(Example) ICSA3 (ICSPA3) - BC1MS1M - A - 70AQL - 40AQL - 30BLNM - T1 - 5L - SC-SC



* Refer to page 51 for the details of model specification items.

Models/Specifications * [] is for the high-precision specification.

Encoder Type	XY-axis configuration direction (*1)	Z-axis type (*2)	Model
Absolute	1	M	ICSA3 [ICSPA3] -BC1MS1M-A- [1] - [2] - [3] -BNM-T1- [4] - [5]
		L	ICSA3 [ICSPA3] -BC1MS1L-A- [1] - [2] - [3] -BNM-T1- [4] - [5]
	2	M	ICSA3 [ICSPA3] -BC2MS1M-A- [1] - [2] - [3] -BNM-T1- [4] - [5]
		L	ICSA3 [ICSPA3] -BC2MS1L-A- [1] - [2] - [3] -BNM-T1- [4] - [5]
	3	M	ICSA3 [ICSPA3] -BC3MS1M-A- [1] - [2] - [3] -BNM-T1- [4] - [5]
		L	ICSA3 [ICSPA3] -BC3MS1L-A- [1] - [2] - [3] -BNM-T1- [4] - [5]
	4	M	ICSA3 [ICSPA3] -BC4MS1M-A- [1] - [2] - [3] -BNM-T1- [4] - [5]
		L	ICSA3 [ICSPA3] -BC4MS1L-A- [1] - [2] - [3] -BNM-T1- [4] - [5]
Incremental	1	M	ICSA3 [ICSPA3] -BC1MS1M-I- [1] - [2] - [3] -BNM-T1- [4] - [5]
		L	ICSA3 [ICSPA3] -BC1MS1L-I- [1] - [2] - [3] -BNM-T1- [4] - [5]
	2	M	ICSA3 [ICSPA3] -BC2MS1M-I- [1] - [2] - [3] -BNM-T1- [4] - [5]
		L	ICSA3 [ICSPA3] -BC2MS1L-I- [1] - [2] - [3] -BNM-T1- [4] - [5]
	3	M	ICSA3 [ICSPA3] -BC3MS1M-I- [1] - [2] - [3] -BNM-T1- [4] - [5]
		L	ICSA3 [ICSPA3] -BC3MS1L-I- [1] - [2] - [3] -BNM-T1- [4] - [5]
	4	M	ICSA3 [ICSPA3] -BC4MS1M-I- [1] - [2] - [3] -BNM-T1- [4] - [5]
		L	ICSA3 [ICSPA3] -BC4MS1L-I- [1] - [2] - [3] -BNM-T1- [4] - [5]

*1: Refer to the figure below for XY-axis configuration direction.
*2: The load capacity and the maximum speed may vary depending on the type of Z-axis.
Note: T1 in the above models will be T2 when operated with XSEL-P/Q type.

Explanation of Model Code

Number	Contents	Specification
[1]	X-axis stroke (Note 1)	20 : 200mm ~ 80 : 800mm
[2]	Y-axis stroke (Note 1)	10 : 100mm ~ 50 : 500mm
[3]	Z-axis stroke (Note 1)	10 : 100mm ~ 30 : 300mm
[4]	Cable length (Note 2)	3L : 3m 5L : 5m
[5]	Y-axis/ Z-axis cable management	SC-SC : Self-standing cable

* The above explains the Models/Specifications chart to the left.

Options

Please add the option codes at the end of each stroke of the axis. When adding multiple options, put together in alphabetic order.

Name	Code	Page
AQ seal	AQ	P13
Brake	B	P13
Creep sensor	C	P13
Home limit switch	L	P14
Reversed-home specification	NM	P14
Guide with ball-retaining mechanism	RT	P14

Configuration Direction

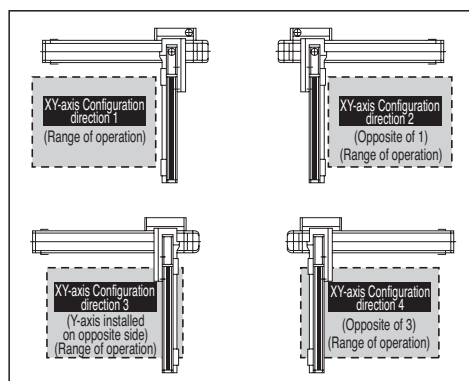

Common Specifications * [] is for the high-precision specification.

Drive system	Ball screw, rolled C10 [equivalent to rolled C5]
Positioning repeatability	±0.02mm [±0.01mm]
Backlash	0.05mm or less [0.02mm or less]
Guide	Integrated with base
Base	Material: Aluminum with white alumite treatment
X-axis motor output / lead	100W / 10mm
Y-axis motor output / lead	100W / 10mm
Z-axis motor output / lead	60W / 8mm (M), 4mm (L)

Applicable Controller Specifications

Refer to page 65 for System Configuration.

Axis Configuration * [] is for the high-precision specification.

Axis Type	Model	Page
X-axis	ISA[ISPA]-MXM-□-100-10-(Stroke)-T1	P18
Y-axis	ISA[ISPA]-MYM-□-100-10-(Stroke)-T1	P21
Z-axis	ISA[ISPA]-SZM-□-60-8/4-(Stroke)-T1-B-NM	P17

* In the above model name, □ indicates encoder type A (absolute) or I (incremental).



Caution

(Note 1) The stroke in the model is specified in cm (centimeters).
(Note 2) The cable length measures from the X-axis connector box to the controller. The standard lengths are 3m and 5m, but other lengths can also be specified in meters. The maximum length is 20m.
(Note 3) The rated acceleration is 0.3G. Increasing the acceleration will result in lower load capacity.
(Note 4) Please note that a longer stroke will result in a lower maximum speed.

* For other points to note, please refer to page 49.

ICSA3 [ICSPA3] -BC□MS1□

Load Capacity (kg) (Note3)

BC□MS1M

		Y-axis stroke			
		100	200	300	400
Z-axis stroke	100	3.0			
	200	2.3			
	300	1.6			

BC□MS1L

		Y-axis stroke			
		100	200	300	400
Z-axis stroke	100	11.0			
	200	10.3			
	300	9.6			

Maximum Speed by Stroke (mm/sec) (Note4)

BC□MS1M

	Stroke								
	100	200	300	400	500	600	700	800	
X-axis	-	500					480	380	
Y-axis	500				-	-	-	-	
Z-axis	400		-	-	-	-	-	-	

BC□MS1L

	Stroke								
	100	200	300	400	500	600	700	800	
X-axis	-	500					480	380	
Y-axis	500				-	-	-	-	
Z-axis	200		-	-	-	-	-	-	

Dimensions

* The dimension below is for XY-axis Configuration direction 1.

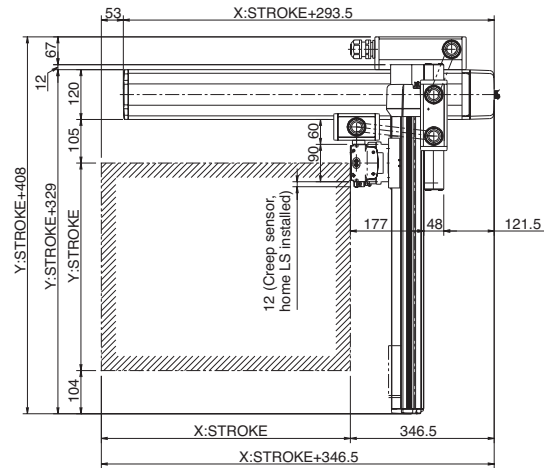
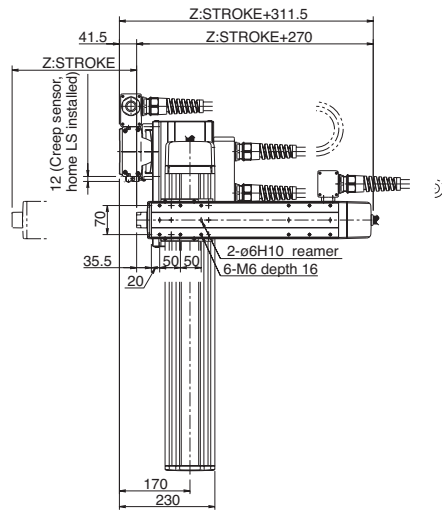

* The configuration position in the figure is home position. To change the home position, indicate NM in the option. Note that changing the home direction will require the actuator to be returned to IAI for adjustment.

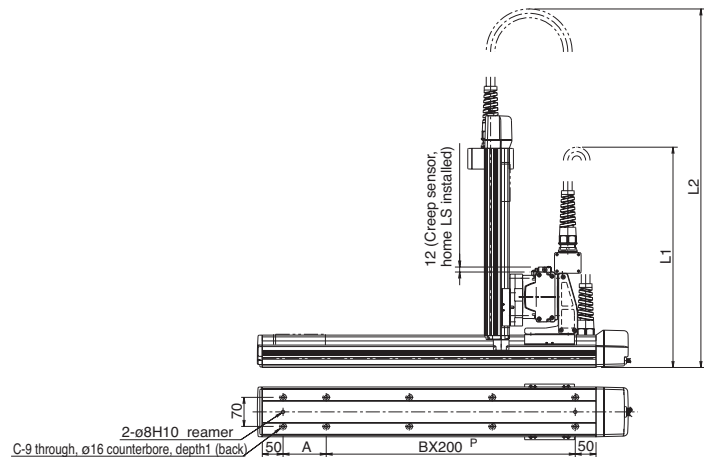

X stroke	200	300	400	500	600	700	800
L1	(550)	(600)	(650)	(700)	(750)	(800)	(850)
A	104	204	104	204	104	204	104
B	1	1	2	2	3	3	4
C	6	6	8	8	10	10	12

		Y stroke				
		100	200	300	400	500
Z stroke	100	(630)	(680)	(730)	(780)	(830)
	200	(730)	(780)	(830)	(880)	(930)
	300	(830)	(880)	(930)	(980)	(1030)

ICSA3-BC MS3M

Cartesian Robot: X-Y-Z 3-Axes Configuration
Z-Axis Slider Mount Type

ICSPA3-BC MS3M

Cartesian Robot: X-Y-Z 3-Axes Configuration
Z-Axis Slider Mount Type High-Precision Specification

Type XYB + Z-Axis Slider Mount Type Stroke X-axis: 200-800mm Y-axis: 100-500mm Z-axis: 100-300mm Load capacity 11.9kg ~ 6.7kg

Model specification items Series Type Encoder type X-axis stroke + options Y-axis stroke + options Z-axis stroke + options Applicable controller Cable length Cable management
(Example) ICSA3 [ICSPA3] - BC1MS3M - A - 70AQL - 40AQL - 30BLNM - T1 - 5L - SC - SC



* Refer to page 51 for the details of model specification items.

Models/Specifications

* [] is for the high-precision specification.

Encoder Type	XY-axis configuration direction (*1)	Z-axis type (*2)	Model
Absolute	1	M	ICSA3 [ICSPA3] -BC1MS3M-A- <input type="checkbox"/> - <input type="checkbox"/> - <input type="checkbox"/> -BNM-T1- <input type="checkbox"/> - <input type="checkbox"/>
	2	M	ICSA3 [ICSPA3] -BC2MS3M-A- <input type="checkbox"/> - <input type="checkbox"/> - <input type="checkbox"/> -BNM-T1- <input type="checkbox"/> - <input type="checkbox"/>
	3	M	ICSA3 [ICSPA3] -BC3MS3M-A- <input type="checkbox"/> - <input type="checkbox"/> - <input type="checkbox"/> -BNM-T1- <input type="checkbox"/> - <input type="checkbox"/>
	4	M	ICSA3 [ICSPA3] -BC4MS3M-A- <input type="checkbox"/> - <input type="checkbox"/> - <input type="checkbox"/> -BNM-T1- <input type="checkbox"/> - <input type="checkbox"/>
Incremental	1	M	ICSA3 [ICSPA3] -BC1MS3M-I- <input type="checkbox"/> - <input type="checkbox"/> - <input type="checkbox"/> -BNM-T1- <input type="checkbox"/> - <input type="checkbox"/>
	2	M	ICSA3 [ICSPA3] -BC2MS3M-I- <input type="checkbox"/> - <input type="checkbox"/> - <input type="checkbox"/> -BNM-T1- <input type="checkbox"/> - <input type="checkbox"/>
	3	M	ICSA3 [ICSPA3] -BC3MS3M-I- <input type="checkbox"/> - <input type="checkbox"/> - <input type="checkbox"/> -BNM-T1- <input type="checkbox"/> - <input type="checkbox"/>
	4	M	ICSA3 [ICSPA3] -BC4MS3M-I- <input type="checkbox"/> - <input type="checkbox"/> - <input type="checkbox"/> -BNM-T1- <input type="checkbox"/> - <input type="checkbox"/>

*1: Refer to the figure below for XY-axis configuration direction.

*2: The load capacity and the maximum speed may vary depending on the type of Z-axis.

Note: T1 in the above models will be T2 when operated with XSEL-P/Q type.

Explanation of Model Code

Number	Contents	Specification
<input type="checkbox"/>	X-axis stroke (Note 1)	20 : 200mm ~ 80 : 800mm
<input type="checkbox"/>	Y-axis stroke (Note 1)	10 : 100mm ~ 50 : 500mm
<input type="checkbox"/>	Z-axis stroke (Note 1)	10 : 100mm ~ 30 : 300mm
<input type="checkbox"/>	Cable length (Note 2)	3L : 3m 5L : 5m
<input type="checkbox"/>	Y-axis/ Z-axis cable management	SC-SC : Self-standing cable

* The above explains the Models/Specifications chart to the left.

Options

Please add the option codes at the end of each stroke of the axis.
When adding multiple options, put together in alphabetic order.

Name	Code	Page
AQ seal	AQ	P13
Brake	B	P13
Creep sensor	C	P13
Home limit switch	L	P14
Reversed-home specification	NM	P14
Guide with ball-retaining mechanism	RT	P14

Configuration Direction

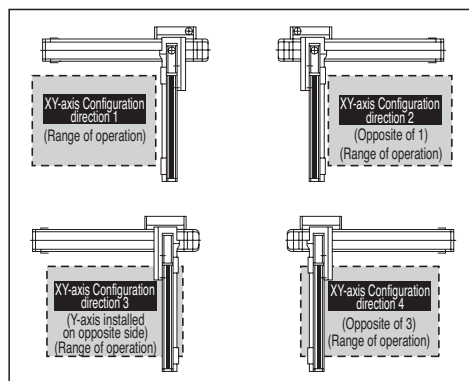

Common Specifications

* [] is for the high-precision specification.

Drive system	Ball screw, rolled C10 [equivalent to rolled C5]
Positioning repeatability	±0.02mm [±0.01mm]
Backlash	0.05mm or less [0.02mm or less]
Guide	Integrated with base
Base	Material: Aluminum with white alumite treatment
X-axis motor output / lead	100W / 10mm
Y-axis motor output / lead	100W / 10mm
Z-axis motor output / lead	200W / 10mm (M)

Applicable Controller Specifications

Refer to page 65 for System Configuration.

Axis Configuration

* [] is for the high-precision specification.

Axis Type	Model	Page
X-axis	ISA[ISPA]-MXM- <input type="checkbox"/> -100-10-(Stroke)-T1	P18
Y-axis	ISA[ISPA]-MYM- <input type="checkbox"/> -100-10-(Stroke)-T1	P21
Z-axis	ISA[ISPA]-MZM- <input type="checkbox"/> -200-10-(Stroke)-T1-B-NM	P24

* In the above model name, indicates encoder type A (absolute) or I (incremental).



Caution

(Note 1) The stroke in the model is specified in cm (centimeters).

(Note 2) The cable length measures from the X-axis connector box to the controller. The standard lengths are 3m and 5m, but other lengths can also be specified in meters. The maximum length is 20m.

(Note 3) The rated acceleration is 0.3G. Increasing the acceleration will result in lower load capacity.

(Note 4) Please note that a longer stroke will result in a lower maximum speed.

* For other points to note, please refer to page 49.

ICSA3 [ICSPA3] -BC□MS3M

Single-Axis Robots
Cartesian Robots

Load Capacity (kg) (Note3)

BC□MS3M

		Y-axis stroke				
		100	200	300	400	500
Z-axis stroke	100	11.9			11.8	8.7
	200	10.9			10.8	7.7
	300	9.9			9.8	6.7

Maximum Speed by Stroke (mm/sec) (Note4)

BC□MS3M

		Stroke							
		100	200	300	400	500	600	700	800
X-axis	-	500						480	380
Y-axis		500		-	-	-	-	-	
Z-axis		500		-	-	-	-	-	

Dimensions * The dimension below is for XY-axis Configuration direction 1.

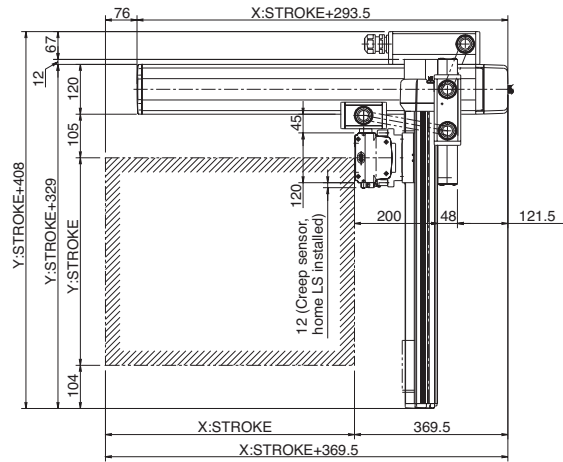
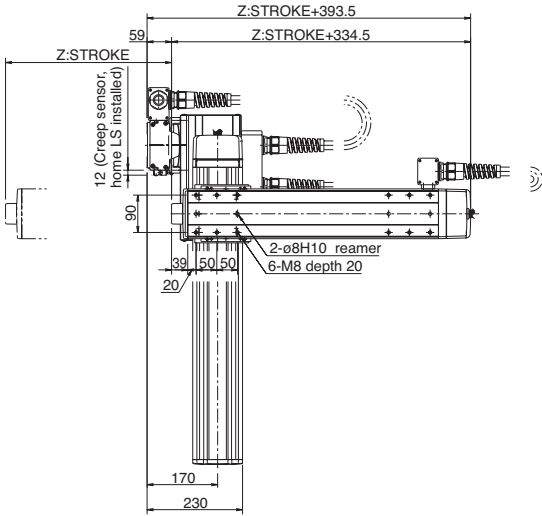

* The configuration position in the figure is home position. To change the home position, indicate NM in the option. Note that changing the home direction will require the actuator to be returned to IA1 for adjustment.

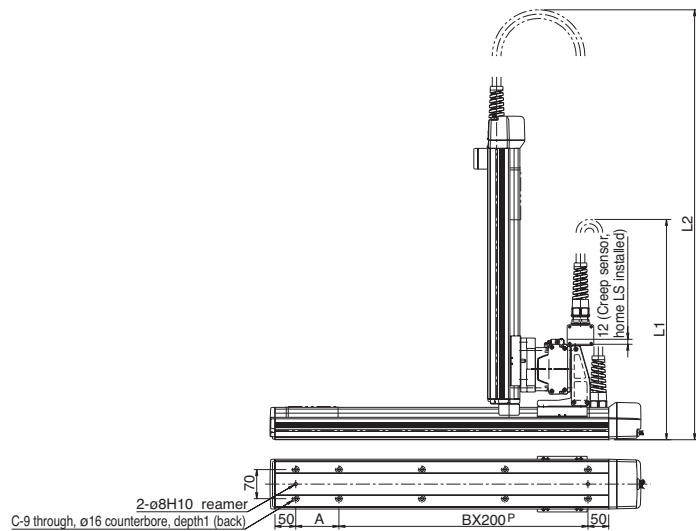

X stroke	200	300	400	500	600	700	800
L1	(550)	(600)	(650)	(700)	(750)	(800)	(850)
A	104	204	104	204	104	204	104
B	1	1	2	2	3	3	4
C	6	6	8	8	10	10	12

		Y stroke				
Z stroke	100	(670)	(720)	(770)	(820)	(870)
	200	(770)	(820)	(870)	(920)	(970)
	300	(870)	(920)	(970)	(1020)	(1070)
	400	(970)	(1020)	(1070)	(1120)	(1170)

ICSA3-BD HS1 Cartesian Robot: X-Y-Z 3-Axes Configuration Z-Axis Slider Mount Type

ICSPA3-BD HS1 Cartesian Robot: X-Y-Z 3-Axes Configuration Z-Axis Slider Mount Type High-Precision Specification

Type XYB + Z-Axis Slider Mount Type **Stroke** X-axis: 800-2000mm Y-axis: 100-500mm Z-axis: 100-300mm **Load capacity** 11kg ~ 1.6kg

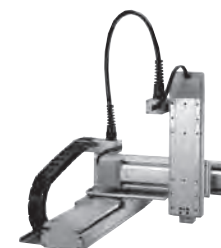

Model specification items Series Type Encoder type X-axis stroke + options Y-axis stroke + options Z-axis stroke + options Applicable controller Cable length Cable management
 (Example) ICSA3 (ICSPA3) - BDHS1M - A - 100AQL - 40AQL - 30BLNM - T1 - 5L - CT - SC

* Refer to page 51 for the details of model specification items.

Models/Specifications

* [] is for the high-precision specification.

Encoder Type	XY-axis configuration direction (*1)	Z-axis type (*2)	Model
Absolute	1	M	ICSA3 [ICSPA3] -BD1HS1M-A- [1]- [2]- [3]-BNM-T1- [4]- [5]
		L	ICSA3 [ICSPA3] -BD1HS1L-A- [1]- [2]- [3]-BNM-T1- [4]- [5]
	2	M	ICSA3 [ICSPA3] -BD2HS1M-A- [1]- [2]- [3]-BNM-T1- [4]- [5]
		L	ICSA3 [ICSPA3] -BD2HS1L-A- [1]- [2]- [3]-BNM-T1- [4]- [5]
	3	M	ICSA3 [ICSPA3] -BD3HS1M-A- [1]- [2]- [3]-BNM-T1- [4]- [5]
		L	ICSA3 [ICSPA3] -BD3HS1L-A- [1]- [2]- [3]-BNM-T1- [4]- [5]
	4	M	ICSA3 [ICSPA3] -BD4HS1M-A- [1]- [2]- [3]-BNM-T1- [4]- [5]
		L	ICSA3 [ICSPA3] -BD4HS1L-A- [1]- [2]- [3]-BNM-T1- [4]- [5]
Incremental	1	M	ICSA3 [ICSPA3] -BD1HS1M-I- [1]- [2]- [3]-BNM-T1- [4]- [5]
		L	ICSA3 [ICSPA3] -BD1HS1L-I- [1]- [2]- [3]-BNM-T1- [4]- [5]
	2	M	ICSA3 [ICSPA3] -BD2HS1M-I- [1]- [2]- [3]-BNM-T1- [4]- [5]
		L	ICSA3 [ICSPA3] -BD2HS1L-I- [1]- [2]- [3]-BNM-T1- [4]- [5]
	3	M	ICSA3 [ICSPA3] -BD3HS1M-I- [1]- [2]- [3]-BNM-T1- [4]- [5]
		L	ICSA3 [ICSPA3] -BD3HS1L-I- [1]- [2]- [3]-BNM-T1- [4]- [5]
	4	M	ICSA3 [ICSPA3] -BD4HS1M-I- [1]- [2]- [3]-BNM-T1- [4]- [5]
		L	ICSA3 [ICSPA3] -BD4HS1L-I- [1]- [2]- [3]-BNM-T1- [4]- [5]

*1: Refer to the figure below for XY-axis configuration direction.
 *2: The load capacity and the maximum speed may vary depending on the type of Z-axis.
 Note: T1 in the above models will be T2 when operated with XSEL-P/Q type.

Explanation of Model Code

Number	Contents	Specification
[1]	X-axis stroke (Note 1)	80 : 800mm ~ 200 : 2000mm
[2]	Y-axis stroke (Note 1)	10 : 100mm ~ 50 : 500mm
[3]	Z-axis stroke (Note 1)	10 : 100mm ~ 30 : 300mm
[4]	Cable length (Note 2)	3L : 3m 5L : 5m
[5]	Y-axis/ Z-axis cable management	CT-SC : Self-standing cable (*3)

* The above explains the Models/Specifications chart to the left.
 *3 Only cable track can be specified for the Y-axis cable management with model # BDHS1M.

Options

Please add the option codes at the end of each stroke of the axis.
 When adding multiple options, put together in alphabetic order.

Name	Code	Page
AQ seal	AQ	P13
Brake	B	P13
Creep sensor	C	P13
Home limit switch	L	P14
Reversed-home specification	NM	P14
Guide with ball-retaining mechanism	RT	P14

Configuration Direction

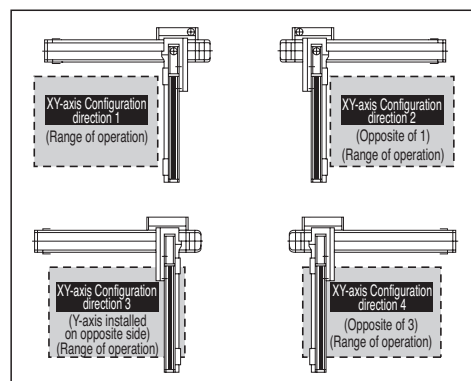

Common Specifications

* [] is for the high-precision specification.

Drive system	Ball screw, rolled C10 [equivalent to rolled C5]
Positioning repeatability	±0.02mm [±0.01mm]
Backlash	0.05mm or less [0.02mm or less]
Guide	Integrated with base
Base	Material: Aluminum with white alumite treatment
X-axis motor output / lead	200W / 20mm
Y-axis motor output / lead	100W / 20mm
Z-axis motor output / lead	60W / 8mm (M), 4mm (L)

Applicable Controller Specifications

Refer to page 65 for System Configuration.

Axis Configuration

* [] is for the high-precision specification.

Axis Type	Model	Page
X-axis	ISA[ISPA]-MXM-[]-200-20-(Stroke)-T1	P20
Y-axis	ISA[ISPA]-MYM-[]-100-20-(Stroke)-T1	P21
Z-axis	ISA[ISPA]-SZM-[]-60-8/4-(Stroke)-T1-B-NM	P17

* In the above model name, [] indicates encoder type A (absolute) or I (incremental).



Caution

(Note 1) The stroke in the model is specified in cm (centimeters).
 (Note 2) The cable length measures from the X-axis connector box to the controller. The standard lengths are 3m and 5m, but other lengths can also be specified in meters. The maximum length is 20m.
 (Note 3) The rated acceleration is 0.3G. Increasing the acceleration will result in lower load capacity.
 (Note 4) Please note that a longer stroke will result in a lower maximum speed.

* For other points to note, please refer to page 49.

ICSA3 [ICSPA3] -BD□HS1□

Load Capacity (kg) (Note3)

BD□HS1M

		Y-axis stroke				
		100	200	300	400	500
Z-axis stroke	100	3.0				
	200	2.3				
	300	1.6				

BD□HS1L

		Y-axis stroke				
		100	200	300	400	500
Z-axis stroke	100	11.0				
	200	10.3				
	300	9.6				

Maximum Speed by Stroke (mm/sec) (Note4)

BD□HS1M

	Stroke									
	100 ~ 400	500	800 ~ 1300	1400	1500	1600	1700	1800	1900	2000
X-axis	-	-	1000	950	800	700	600	550	500	450
Y-axis	1000		-	-	-	-	-	-	-	-
Z-axis	400	-	-	-	-	-	-	-	-	-

BD□HS1L

	Stroke									
	100 ~ 400	500	800 ~ 1300	1400	1500	1600	1700	1800	1900	2000
X-axis	-	-	1000	950	800	700	600	550	500	450
Y-axis	1000		-	-	-	-	-	-	-	-
Z-axis	200	-	-	-	-	-	-	-	-	-

Dimensions * The dimension below is for XY-axis Configuration direction 1.

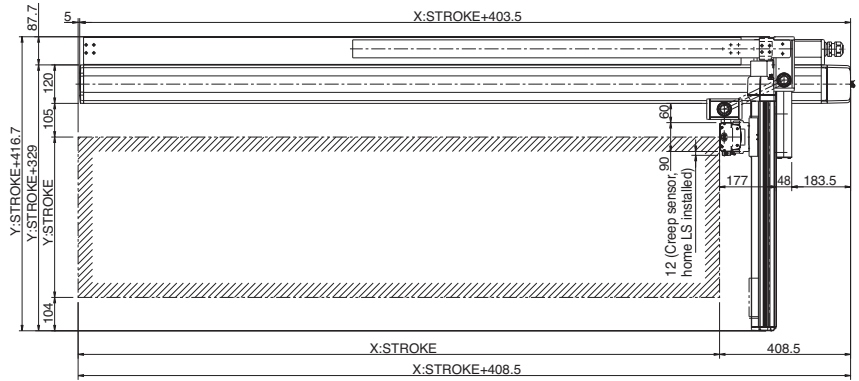
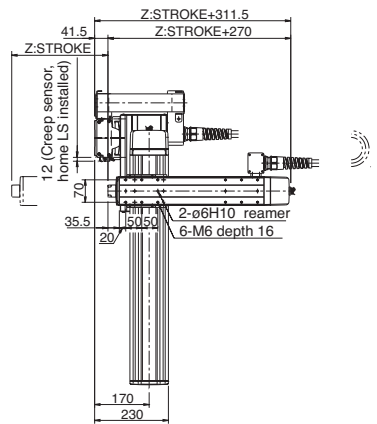

* The configuration position in the figure is home position. To change the home position, indicate NM in the option. Note that changing the home direction will require the actuator to be returned to IAI for adjustment.

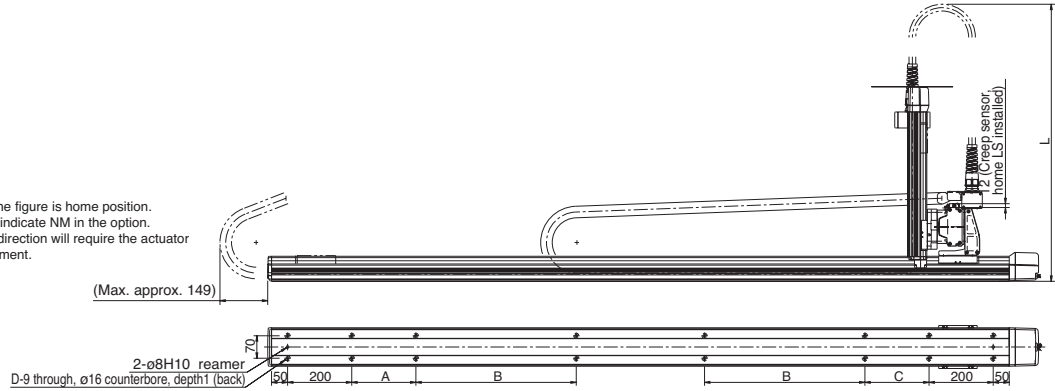

X st	800	900	1000	1100	1200	1300	1400	1500	1600	1700	1800	1900	2000
A	0	0	200	250	300	350	400	450	500	550	200	200	200
B	0	0	0	0	0	0	0	0	0	0	400	450	500
C	200	200	200	250	300	350	400	450	500	550	200	200	200
D	10	10	12	12	12	12	12	12	12	12	16	16	16

		Y stroke				
		100	200	300	400	500
Z stroke	100	(630)	(680)	(730)	(780)	(830)
	200	(730)	(780)	(830)	(880)	(930)
	300	(830)	(880)	(930)	(980)	(1030)

ICSA3-BD <input type="checkbox"/> HS3M	Cartesian Robot: X-Y-Z 3-Axes Configuration Z-Axis Slider Mount Type																				
ICSPA3-BD <input type="checkbox"/> HS3M	Cartesian Robot: X-Y-Z 3-Axes Configuration Z-Axis Slider Mount Type High-Precision Specification																				
Type XYB + Z-axis Slider Mount Type	Stroke X-axis: 800-2000mm Y-axis: 100-500mm Z-axis: 100-300mm																				
Load capacity 10kg ~ 6.7kg																					
<table border="1"> <tr> <th>Model specification items</th> <th>Series</th> <th>Type</th> <th>Encoder type</th> <th>X-axis stroke + options</th> <th>Y-axis stroke + options</th> <th>Z-axis stroke + options</th> <th>Applicable controller</th> <th>Cable length</th> <th>Cable management</th> </tr> <tr> <td>(Example)</td> <td>ICSA3 (ICSPA3)</td> <td>-BD1HS3M-</td> <td>A</td> <td>-100AQL-</td> <td>-40AQL-</td> <td>-30BLNM-</td> <td>T1</td> <td>-5L-</td> <td>CT-SC</td> </tr> </table>		Model specification items	Series	Type	Encoder type	X-axis stroke + options	Y-axis stroke + options	Z-axis stroke + options	Applicable controller	Cable length	Cable management	(Example)	ICSA3 (ICSPA3)	-BD1HS3M-	A	-100AQL-	-40AQL-	-30BLNM-	T1	-5L-	CT-SC
Model specification items	Series	Type	Encoder type	X-axis stroke + options	Y-axis stroke + options	Z-axis stroke + options	Applicable controller	Cable length	Cable management												
(Example)	ICSA3 (ICSPA3)	-BD1HS3M-	A	-100AQL-	-40AQL-	-30BLNM-	T1	-5L-	CT-SC												

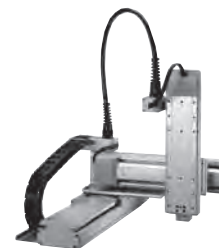

* Refer to page 51 for the details of model specification items.

Models/Specifications

* [] is for the high-precision specification.

Encoder Type	XY-axis configuration direction (*1)	Z-axis type (*2)	Model
Absolute	1	M	ICSA3 [ICSPA3] -BD1HS3M-A- <input type="checkbox"/> - <input type="checkbox"/> - <input type="checkbox"/> -BNM-T1- <input type="checkbox"/> - <input type="checkbox"/>
	2	M	ICSA3 [ICSPA3] -BD2HS3M-A- <input type="checkbox"/> - <input type="checkbox"/> - <input type="checkbox"/> -BNM-T1- <input type="checkbox"/> - <input type="checkbox"/>
	3	M	ICSA3 [ICSPA3] -BD3HS3M-A- <input type="checkbox"/> - <input type="checkbox"/> - <input type="checkbox"/> -BNM-T1- <input type="checkbox"/> - <input type="checkbox"/>
	4	M	ICSA3 [ICSPA3] -BD4HS3M-A- <input type="checkbox"/> - <input type="checkbox"/> - <input type="checkbox"/> -BNM-T1- <input type="checkbox"/> - <input type="checkbox"/>
Incremental	1	M	ICSA3 [ICSPA3] -BD1HS3M-I- <input type="checkbox"/> - <input type="checkbox"/> - <input type="checkbox"/> -BNM-T1- <input type="checkbox"/> - <input type="checkbox"/>
	2	M	ICSA3 [ICSPA3] -BD2HS3M-I- <input type="checkbox"/> - <input type="checkbox"/> - <input type="checkbox"/> -BNM-T1- <input type="checkbox"/> - <input type="checkbox"/>
	3	M	ICSA3 [ICSPA3] -BD3HS3M-I- <input type="checkbox"/> - <input type="checkbox"/> - <input type="checkbox"/> -BNM-T1- <input type="checkbox"/> - <input type="checkbox"/>
	4	M	ICSA3 [ICSPA3] -BD4HS3M-I- <input type="checkbox"/> - <input type="checkbox"/> - <input type="checkbox"/> -BNM-T1- <input type="checkbox"/> - <input type="checkbox"/>

*1: Refer to the figure below for XY-axis configuration direction.

*2: The load capacity and the maximum speed may vary depending on the type of Z-axis.

Note: T1 in the above models will be T2 when operated with XSEL-P/Q type.

Explanation of Model Code

Number	Contents	Specification
<input type="checkbox"/>	X-axis stroke (Note 1)	80 : 800mm ~ 200 : 2000mm
<input type="checkbox"/>	Y-axis stroke (Note 1)	10 : 100mm ~ 50 : 500mm
<input type="checkbox"/>	Z-axis stroke (Note 1)	10 : 100mm ~ 30 : 300mm
<input type="checkbox"/>	Cable length (Note 2)	3L : 3m 5L : 5m
<input type="checkbox"/>	Y-axis/ Z-axis cable management	SC-SC : Self-standing cable (*3)

* The above explains the Models/Specifications chart to the left.

*3 Only cable track can be specified for the Y-axis cable management with model # BDHS3.

Options

Please add the option codes at the end of each stroke of the axis. When adding multiple options, put together in alphabetic order.

Name	Code	Page
AQ seal	AQ	P13
Brake	B	P13
Creep sensor	C	P13
Home limit switch	L	P14
Reversed-home specification	NM	P14
Guide with ball-retaining mechanism	RT	P14

Configuration Direction

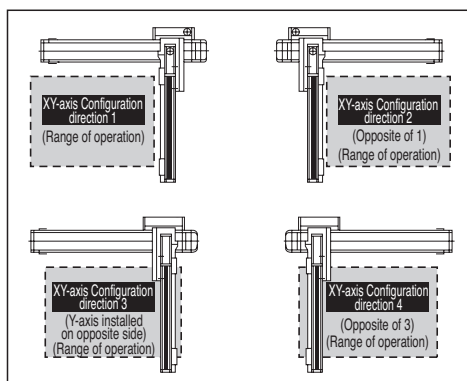

Common Specifications

* [] is for the high-precision specification.

Drive system	Ball screw, rolled C10 [equivalent to rolled C5]
Positioning repeatability	±0.02mm [±0.01mm]
Backlash	0.05mm or less [0.02mm or less]
Guide	Integrated with base
Base	Material: Aluminum with white alumite treatment
X-axis motor output / lead	200W / 20mm
X-axis motor output / lead	100W / 20mm
X-axis motor output / lead	200W / 10mm (M)

Applicable Controller Specifications

Refer to page 65 for System Configuration.

Axis Configuration

* [] is for the high-precision specification.

Axis Type	Model	Page
X-axis	ISA[ISPA]-MXM- <input type="checkbox"/> -200-20-(Stroke)-T1	P20
Y-axis	ISA[ISPA]-MYM- <input type="checkbox"/> -100-20-(Stroke)-T1	P21
Z-axis	ISA[ISPA]-MZM- <input type="checkbox"/> -200-10-(Stroke)-T1-B-NM	P24

*In the above model name, indicates encoder type A (absolute) or I (incremental).



Caution

(Note 1) The stroke in the model is specified in cm (centimeters).

(Note 2) The cable length measures from the X-axis connector box to the controller. The standard lengths are 3m and 5m, but other lengths can also be specified in meters. The maximum length is 20m.

(Note 3) The rated acceleration is 0.3G. Increasing the acceleration will result in lower load capacity.

(Note 4) Please note that a longer stroke will result in a lower maximum speed.

* For other points to note, please refer to page 49.

ICSA3 [ICSPA3] -BD□HS3M

Load Capacity (kg) (Note3)

■BC□HS3M

		Y-axis stroke				
		100	200	300	400	500
Z-axis stroke	100	10.0				8.7
	200	9.0				7.7
	300	8.0				6.7

Maximum Speed by Stroke (mm/sec) (Note4)

■BC□HS3M

	Stroke									
	100 ~ 300	400 ~ 500	800 ~ 1300	1400	1500	1600	1700	1800	1900	2000
X-axis	-	-	1000	950	800	700	600	550	500	450
Y-axis	1000									
Z-axis	500	-	-	-	-	-	-	-	-	-

Dimensions * The dimension below is for XY-axis Configuration direction 1.

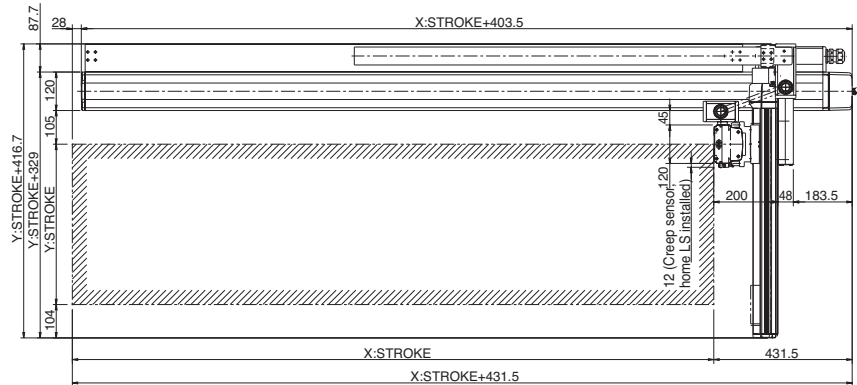
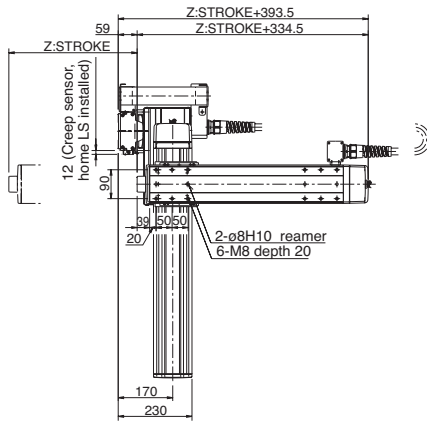

* The configuration position in the figure is home position. To change the home position, indicate NM in the option. Note that changing the home direction will require the actuator to be returned to IAI for adjustment.

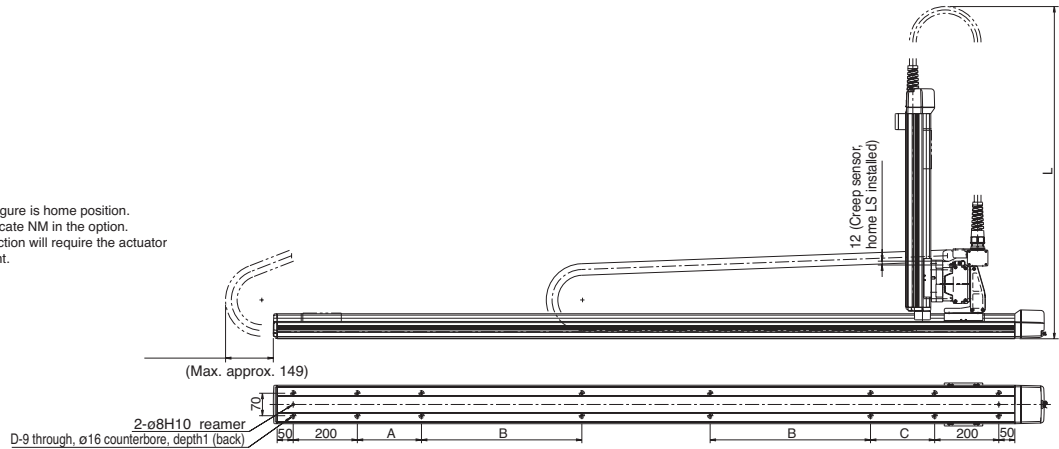

X st	800	900	1000	1100	1200	1300	1400	1500	1600	1700	1800	1900	2000
A	0	0	200	250	300	350	400	450	500	550	200	200	200
B	0	0	0	0	0	0	0	0	0	0	400	450	500
C	200	200	200	250	300	350	400	450	500	550	200	200	200
D	10	10	12	12	12	12	12	12	12	12	16	16	16

		Y stroke				
		100	200	300	400	500
Z stroke	100	(670)	(720)	(770)	(820)	(870)
	200	(770)	(820)	(870)	(920)	(970)
	300	(870)	(920)	(970)	(1020)	(1070)
	400	(970)	(1020)	(1070)	(1120)	(1170)

ICSA3-BE **HS1**

Cartesian Robot: X-Y-Z 3-Axes Configuration
Z-axis Slider Mount Type

ICSPA3-BE **HS1**

Cartesian Robot: X-Y-Z 3-Axes Configuration
Z-axis Slider Mount Type **High-Precision Specification**

Type XYB + Z-axis Slider Mount Type Stroke X-axis: 300~1000mm Y-axis: 200~700mm Z-axis: 100~400mm Load capacity 11kg ~ 0.9kg

Model specification items Series Type Encoder type X-axis stroke + options Y-axis stroke + options Z-axis stroke + options Applicable controller Cable length Cable management
(Example) ICSA3 (ICSPA3) - BE1HS1M - A - 50AQL - 40AQL - 30BLNM - T1 - 5L - SC - SC



* Refer to page 51 for the details of model specification items.

Models/Specifications

* [] is for the high-precision specification.

Encoder Type	XY-axis configuration direction (*1)	Z-axis type (*2)	Model
Absolute	1	M	ICSA3 [ICSPA3] -BE1HS1M-A- <input type="checkbox"/> - <input type="checkbox"/> - <input type="checkbox"/> -BNM-T1- <input type="checkbox"/> - <input type="checkbox"/>
		L	ICSA3 [ICSPA3] -BE1HS1L-A- <input type="checkbox"/> - <input type="checkbox"/> - <input type="checkbox"/> -BNM-T1- <input type="checkbox"/> - <input type="checkbox"/>
	2	M	ICSA3 [ICSPA3] -BE2HS1M-A- <input type="checkbox"/> - <input type="checkbox"/> - <input type="checkbox"/> -BNM-T1- <input type="checkbox"/> - <input type="checkbox"/>
		L	ICSA3 [ICSPA3] -BE2HS1L-A- <input type="checkbox"/> - <input type="checkbox"/> - <input type="checkbox"/> -BNM-T1- <input type="checkbox"/> - <input type="checkbox"/>
	3	M	ICSA3 [ICSPA3] -BE3HS1M-A- <input type="checkbox"/> - <input type="checkbox"/> - <input type="checkbox"/> -BNM-T1- <input type="checkbox"/> - <input type="checkbox"/>
		L	ICSA3 [ICSPA3] -BE3HS1L-A- <input type="checkbox"/> - <input type="checkbox"/> - <input type="checkbox"/> -BNM-T1- <input type="checkbox"/> - <input type="checkbox"/>
	4	M	ICSA3 [ICSPA3] -BE4HS1M-A- <input type="checkbox"/> - <input type="checkbox"/> - <input type="checkbox"/> -BNM-T1- <input type="checkbox"/> - <input type="checkbox"/>
		L	ICSA3 [ICSPA3] -BE4HS1L-A- <input type="checkbox"/> - <input type="checkbox"/> - <input type="checkbox"/> -BNM-T1- <input type="checkbox"/> - <input type="checkbox"/>
Incremental	1	M	ICSA3 [ICSPA3] -BE1HS1M-I- <input type="checkbox"/> - <input type="checkbox"/> - <input type="checkbox"/> -BNM-T1- <input type="checkbox"/> - <input type="checkbox"/>
		L	ICSA3 [ICSPA3] -BE1HS1L-I- <input type="checkbox"/> - <input type="checkbox"/> - <input type="checkbox"/> -BNM-T1- <input type="checkbox"/> - <input type="checkbox"/>
	2	M	ICSA3 [ICSPA3] -BE2HS1M-I- <input type="checkbox"/> - <input type="checkbox"/> - <input type="checkbox"/> -BNM-T1- <input type="checkbox"/> - <input type="checkbox"/>
		L	ICSA3 [ICSPA3] -BE2HS1L-I- <input type="checkbox"/> - <input type="checkbox"/> - <input type="checkbox"/> -BNM-T1- <input type="checkbox"/> - <input type="checkbox"/>
	3	M	ICSA3 [ICSPA3] -BE3HS1M-I- <input type="checkbox"/> - <input type="checkbox"/> - <input type="checkbox"/> -BNM-T1- <input type="checkbox"/> - <input type="checkbox"/>
		L	ICSA3 [ICSPA3] -BE3HS1L-I- <input type="checkbox"/> - <input type="checkbox"/> - <input type="checkbox"/> -BNM-T1- <input type="checkbox"/> - <input type="checkbox"/>
	4	M	ICSA3 [ICSPA3] -BE4HS1M-I- <input type="checkbox"/> - <input type="checkbox"/> - <input type="checkbox"/> -BNM-T1- <input type="checkbox"/> - <input type="checkbox"/>
		L	ICSA3 [ICSPA3] -BE4HS1L-I- <input type="checkbox"/> - <input type="checkbox"/> - <input type="checkbox"/> -BNM-T1- <input type="checkbox"/> - <input type="checkbox"/>

*1: Refer to the figure below for XY-axis configuration direction.

*2: The load capacity and the maximum speed may vary depending on the type of Z-axis.
Note: T1 in the above models will be T2 when operated with XSEL-P/Q type.

Explanation of Model Code

Number	Contents	Specification
<input type="checkbox"/>	X-axis stroke (Note 1)	30 : 300mm ~ 100 : 1000mm
<input type="checkbox"/>	Y-axis stroke (Note 1)	20 : 200mm ~ 70 : 700mm
<input type="checkbox"/>	Z-axis stroke (Note 1)	10 : 100mm ~ 40 : 400mm
<input type="checkbox"/>	Cable length (Note 2)	3L : 3m 5L : 5m
<input type="checkbox"/>	Y-axis/ Z-axis cable management	SC-SC : Self-standing cable

* The above explains the Models/Specifications chart to the left.

Options

Please add the option codes at the end of each stroke of the axis.
When adding multiple options, put together in alphabetic order.

Name	Code	Page
AQ seal	AQ	P13
Brake	B	P13
Creep sensor	C	P13
Home limit switch	L	P14
Reversed-home specification	NM	P14
Guide with ball-retaining mechanism	RT	P14

Configuration Direction

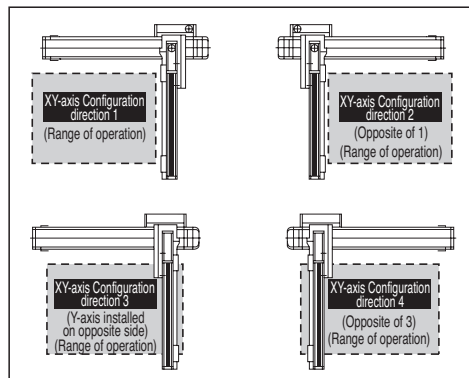

Common Specifications

* [] is for the high-precision specification.

Drive system	Ball screw, rolled C10 [equivalent to rolled C5]
Positioning repeatability	±0.02mm [±0.01mm]
Backlash	0.05mm or less [0.02mm or less]
Guide	Integrated with base
Base	Material: Aluminum with white alumite treatment
X-axis motor output / lead	400W / 20mm
Y-axis motor output / lead	200W / 20mm
Z-axis motor output / lead	60W / 8mm (M), 4mm (L)

Applicable Controller Specifications

Refer to page 65 for System Configuration.

Axis Configuration

* [] is for the high-precision specification.

Axis Type	Model	Page
X-axis	ISA[ISPA]-LXM- <input type="checkbox"/> -400-20-(Stroke)-T1	P26
Y-axis	ISA[ISPA]-MYM- <input type="checkbox"/> -200-20-(Stroke)-T1	P22
Z-axis	ISA[ISPA]-SZM- <input type="checkbox"/> -60-8/4-(Stroke)-T1-B-NM	P17

* In the above model name, indicates encoder type A (absolute) or I (incremental).



Caution

(Note 1) The stroke in the model is specified in cm (centimeters).
(Note 2) The cable length measures from the X-axis connector box to the controller. The standard lengths are 3m and 5m, but other lengths can also be specified in meters. The maximum length is 20m.
(Note 3) The rated acceleration is 0.3G. Increasing the acceleration will result in lower load capacity.
(Note 4) Please note that a longer stroke will result in a lower maximum speed.

* For other points to note, please refer to page 49.

ICSA3 [ICSPA3] -BE□HS1□

Load Capacity (kg) (Note3)

BE□HS1M

		Y-axis stroke					
		200	300	400	500	600	700
Z-axis stroke	100	3.0					
	200	2.3					
	300	1.6					
	400	0.9					

BE□HS1L

		Y-axis stroke					
		200	300	400	500	600	700
Z-axis stroke	100	11.0					
	200	10.3					
	300	9.6					
	400	8.9					

Maximum Speed by Stroke (mm/sec) (Note4)

BE□HS1M

	Stroke										
	100	200	300	400	500	600	700	800	900	1000	
X-axis	-	-	1000						830	690	
Y-axis	-	1000						-	-	-	-
Z-axis	400		-	-	-	-	-	-	-	-	

BE□HS1L

	Stroke										
	100	200	300	400	500	600	700	800	900	1000	
X-axis	-	-	1000						830	690	
Y-axis	-	1000						-	-	-	-
Z-axis	200		-	-	-	-	-	-	-	-	

Dimensions * The dimension below is for XY-axis Configuration direction 1.

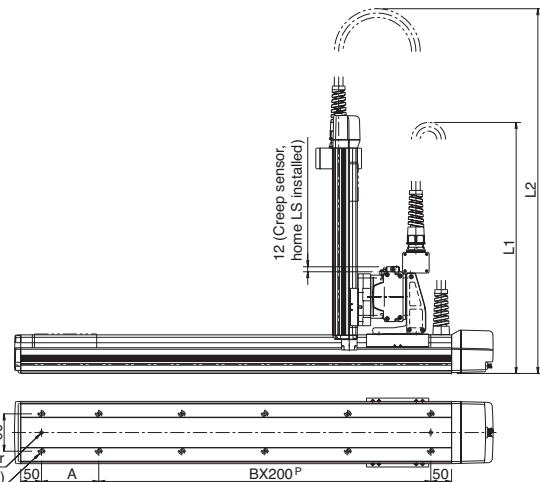
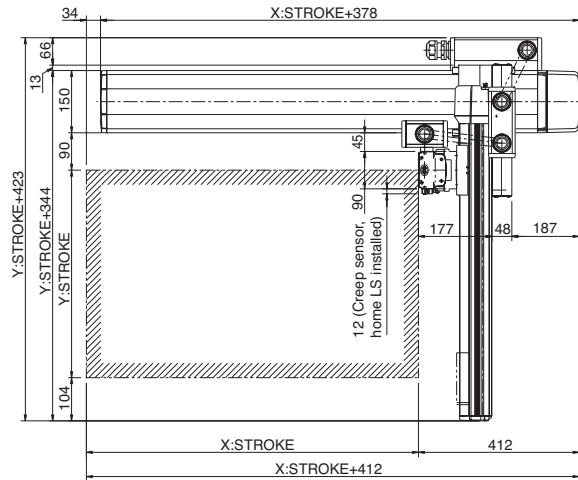
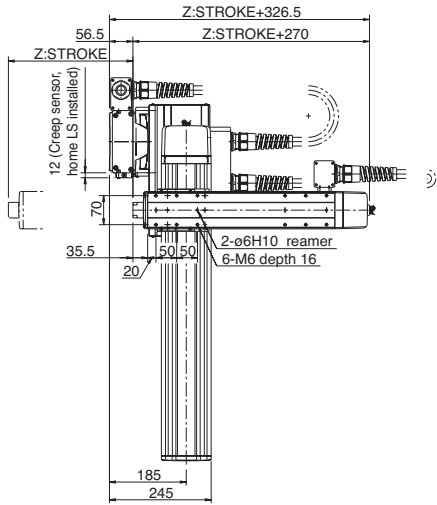

* The configuration position in the figure is home position. To change the home position, indicate NM in the option. Note that changing the home direction will require the actuator to be returned to IAI for adjustment.

X stroke	300	400	500	600	700	800	900	1000
L1	(600)	(650)	(700)	(750)	(800)	(850)	(900)	(950)
A	238	138	238	138	238	138	238	138
B	1	2	2	3	3	4	4	5
C	6	8	8	10	10	12	12	14

		Y stroke					
		200	300	400	500	600	700
Z stroke	100	(700)	(750)	(800)	(850)	(900)	(950)
	200	(800)	(850)	(900)	(950)	(1000)	(1050)
	300	(900)	(950)	(1000)	(1050)	(1100)	(1150)
	400	(1000)	(1050)	(1100)	(1150)	(1200)	(1250)

ICSA3-BE HS3M

Cartesian Robot: X-Y-Z 3-Axes Configuration
Z-Axis Slider Mount Type

ICSPA3-BE HS3M

Cartesian Robot: X-Y-Z 3-Axes Configuration
Z-Axis Slider Mount Type **High-Precision Specification**



Type XYB + Z-Axis Slider Mount Type **Stroke** X-axis: 300~1000mm Y-axis: 200~700mm Z-axis: 100~400mm **Load capacity** 11.9kg ~ 7.5kg

Model specification items Series - Type - Encoder type - X-axis stroke + options - Y-axis stroke + options - Z-axis stroke + options - Applicable controller - Cable length - Cable management
(Example) ICSA3 [ICSPA3] - BE1HS3M - A - 50AQL - 40AQL - 30BLNM - T1 - 5L - SC - SC

* Refer to page 51 for the details of model specification items.

Models/Specifications

* [] is for the high-precision specification.

Encoder Type	XY-axis configuration direction (*1)	Z-axis type (*2)	Model
Absolute	1	M	ICSA3 [ICSPA3] -BE1HS3M-A- <input type="checkbox"/> - <input type="checkbox"/> - <input type="checkbox"/> -BNM-T1- <input type="checkbox"/> - <input type="checkbox"/>
	2	M	ICSA3 [ICSPA3] -BE2HS3M-A- <input type="checkbox"/> - <input type="checkbox"/> - <input type="checkbox"/> -BNM-T1- <input type="checkbox"/> - <input type="checkbox"/>
	3	M	ICSA3 [ICSPA3] -BE3HS3M-A- <input type="checkbox"/> - <input type="checkbox"/> - <input type="checkbox"/> -BNM-T1- <input type="checkbox"/> - <input type="checkbox"/>
	4	M	ICSA3 [ICSPA3] -BE4HS3M-A- <input type="checkbox"/> - <input type="checkbox"/> - <input type="checkbox"/> -BNM-T1- <input type="checkbox"/> - <input type="checkbox"/>
Incremental	1	M	ICSA3 [ICSPA3] -BE1HS3M-I- <input type="checkbox"/> - <input type="checkbox"/> - <input type="checkbox"/> -BNM-T1- <input type="checkbox"/> - <input type="checkbox"/>
	2	M	ICSA3 [ICSPA3] -BE2HS3M-I- <input type="checkbox"/> - <input type="checkbox"/> - <input type="checkbox"/> -BNM-T1- <input type="checkbox"/> - <input type="checkbox"/>
	3	M	ICSA3 [ICSPA3] -BE3HS3M-I- <input type="checkbox"/> - <input type="checkbox"/> - <input type="checkbox"/> -BNM-T1- <input type="checkbox"/> - <input type="checkbox"/>
	4	M	ICSA3 [ICSPA3] -BE4HS3M-I- <input type="checkbox"/> - <input type="checkbox"/> - <input type="checkbox"/> -BNM-T1- <input type="checkbox"/> - <input type="checkbox"/>

*1: Refer to the figure below for XY-axis configuration direction.

*2: The load capacity and the maximum speed may vary depending on the type of Z-axis.

Note: T1 in the above models will be T2 when operated with XSEL-P/Q type.

Explanation of Model Code

Number	Contents	Specification
<input type="checkbox"/>	X-axis stroke (Note 1)	30 : 300mm ~ 100 : 1000mm
<input type="checkbox"/>	Y-axis stroke (Note 1)	20 : 200mm ~ 70 : 700mm
<input type="checkbox"/>	Z-axis stroke (Note 1)	10 : 100mm ~ 40 : 400mm
<input type="checkbox"/>	Cable length (Note 2)	3L : 3m 5L : 5m
<input type="checkbox"/>	Y-axis/ Z-axis cable management	SC-SC : Self-standing cable

* The above explains the Models/Specifications chart to the left.

Options

Please add the option codes at the end of each stroke of the axis. When adding multiple options, put together in alphabetic order.

Name	Code	Page
AQ seal	AQ	P13
Brake	B	P13
Creep sensor	C	P13
Home limit switch	L	P14
Reversed-home specification	NM	P14
Guide with ball-retaining mechanism	RT	P14

Configuration Direction

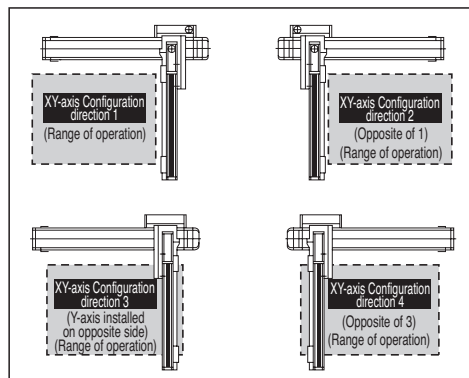

Axis Configuration

* [] is for the high-precision specification.

Axis Type	Model	Page
X-axis	ISA[ISPA]-LXM- <input type="checkbox"/> -400-20-(Stroke)-T1	P26
Y-axis	ISA[ISPA]-MYM- <input type="checkbox"/> -200-20-(Stroke)-T1	P22
Z-axis	ISA[ISPA]-MZM- <input type="checkbox"/> -200-10-(Stroke)-T1-B-NM	P24

* In the above model name, indicates encoder type A (absolute) or I (incremental).

Common Specifications

* [] is for the high-precision specification.

Drive system	Ball screw, rolled C10 [equivalent to rolled C5]
Positioning repeatability	±0.02mm [±0.01mm]
Backlash	0.05mm or less [0.02mm or less]
Guide	Integrated with base
Base	Material: Aluminum with white alumite treatment
X-axis motor output / lead	400W / 20mm
Y-axis motor output / lead	200W / 20mm
Z-axis motor output / lead	200W / 10mm

Applicable Controller Specifications

Refer to page 65 for System Configuration.



Caution

(Note 1) The stroke in the model is specified in cm (centimeters).

(Note 2) The cable length measures from the X-axis connector box to the controller. The standard lengths are 3m and 5m, but other lengths can also be specified in meters. The maximum length is 20m.

(Note 3) The rated acceleration is 0.3G. Increasing the acceleration will result in lower load capacity.

(Note 4) Please note that a longer stroke will result in a lower maximum speed.

* For other points to note, please refer to page 49.

ICSA3 [ICSPA3] -BE□HS3M

Load Capacity (kg) (Note3)

BE□HS3M

		Y-axis stroke					
		200	300	400	500	600	700
Z-axis stroke	100	11.9				10.5	
	200	10.9				9.5	
	300	9.9				8.5	
	400	8.9				7.5	

Maximum Speed by Stroke (mm/sec) (Note4)

BE□HS3M

	Stroke										
	100	200	300	400	500	600	700	800	900	1000	
X-axis	-	-	1000					-	830	690	-
Y-axis	-	1000					-	-	-	-	-
Z-axis	500			-	-	-	-	-	-	-	

Dimensions * The dimension below is for XY-axis Configuration direction 1.

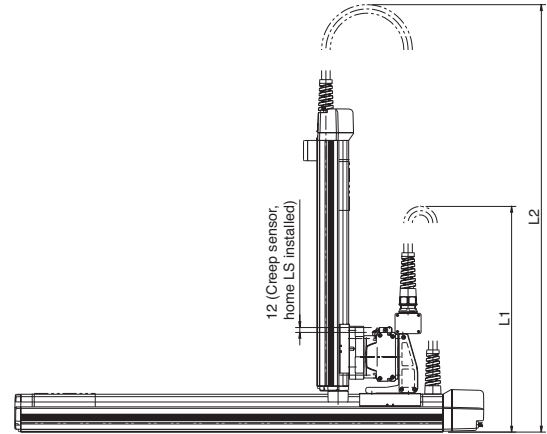
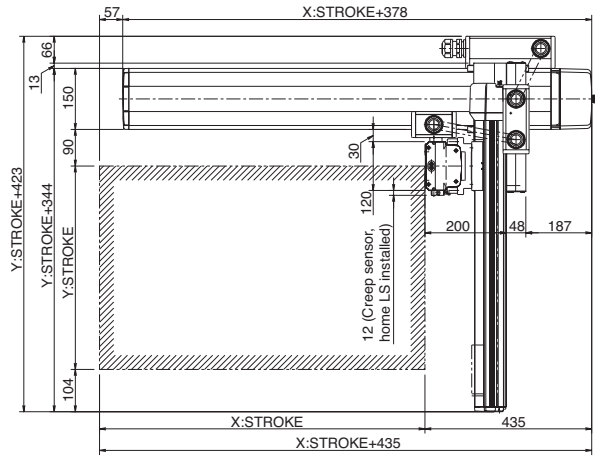
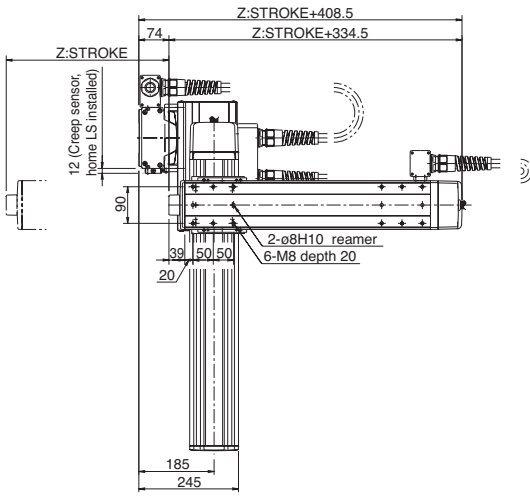

* The configuration position in the figure is home position.
To change the home position, indicate NM in the option.
Note that changing the home direction will require the actuator to be returned to IAI for adjustment.

2-ø8H10 reamer
C-9 through, ø16 counterbore, depth1 (back)

X stroke	300	400	500	600	700	800	900	1000
L1	(600)	(650)	(700)	(750)	(800)	(850)	(900)	(950)
A	238	138	238	138	238	138	238	138
B	1	2	2	3	3	4	4	5
C	6	8	8	10	10	12	12	14

		Y stroke					
		200	300	400	500	600	700
Z stroke	100	(720)	(770)	(820)	(870)	(920)	(970)
	200	(820)	(870)	(920)	(970)	(1020)	(1070)
	300	(920)	(970)	(1020)	(1070)	(1120)	(1170)
	400	(1020)	(1070)	(1120)	(1170)	(1220)	(1270)

ICSA3-BE **MS1** Cartesian Robot: X-Y-Z 3-Axes Configuration
Z-Axis Slider Mount Type

ICSPA3-BE **MS1** Cartesian Robot: X-Y-Z 3-Axes Configuration
Z-Axis Slider Mount Type **High-Precision Specification**

Type XYB + Z-Axis Slider Mount Type Stroke X-axis: 300-1000mm Y-axis: 200-700mm Z-axis: 100-400mm Load capacity 11kg ~ 0.9kg

Model specification items Series Type Encoder type X-axis stroke + options Y-axis stroke + options Z-axis stroke + options Applicable controller Cable length Cable management
(Example) ICSA3 (ICSPA3) - BE1MS1M - A - 50AQL - 40AQL - 30BLNM - T1 - 5L - SC - SC



* Refer to page 51 for the details of model specification items.

Models/Specifications * [] is for the high-precision specification.

Encoder Type	XY-axis configuration direction (*1)	Z-axis type (*2)	Model
Absolute	1	M	ICSA3 [ICSPA3] -BE1MS1M-A- <input type="checkbox"/> - <input type="checkbox"/> - <input type="checkbox"/> -BNM-T1- <input type="checkbox"/> - <input type="checkbox"/>
		L	ICSA3 [ICSPA3] -BE1MS1L-A- <input type="checkbox"/> - <input type="checkbox"/> - <input type="checkbox"/> -BNM-T1- <input type="checkbox"/> - <input type="checkbox"/>
	2	M	ICSA3 [ICSPA3] -BE2MS1M-A- <input type="checkbox"/> - <input type="checkbox"/> - <input type="checkbox"/> -BNM-T1- <input type="checkbox"/> - <input type="checkbox"/>
		L	ICSA3 [ICSPA3] -BE2MS1L-A- <input type="checkbox"/> - <input type="checkbox"/> - <input type="checkbox"/> -BNM-T1- <input type="checkbox"/> - <input type="checkbox"/>
	3	M	ICSA3 [ICSPA3] -BE3MS1M-A- <input type="checkbox"/> - <input type="checkbox"/> - <input type="checkbox"/> -BNM-T1- <input type="checkbox"/> - <input type="checkbox"/>
		L	ICSA3 [ICSPA3] -BE3MS1L-A- <input type="checkbox"/> - <input type="checkbox"/> - <input type="checkbox"/> -BNM-T1- <input type="checkbox"/> - <input type="checkbox"/>
	4	M	ICSA3 [ICSPA3] -BE4MS1M-A- <input type="checkbox"/> - <input type="checkbox"/> - <input type="checkbox"/> -BNM-T1- <input type="checkbox"/> - <input type="checkbox"/>
		L	ICSA3 [ICSPA3] -BE4MS1L-A- <input type="checkbox"/> - <input type="checkbox"/> - <input type="checkbox"/> -BNM-T1- <input type="checkbox"/> - <input type="checkbox"/>
Incremental	1	M	ICSA3 [ICSPA3] -BE1MS1M-I- <input type="checkbox"/> - <input type="checkbox"/> - <input type="checkbox"/> -BNM-T1- <input type="checkbox"/> - <input type="checkbox"/>
		L	ICSA3 [ICSPA3] -BE1MS1L-I- <input type="checkbox"/> - <input type="checkbox"/> - <input type="checkbox"/> -BNM-T1- <input type="checkbox"/> - <input type="checkbox"/>
	2	M	ICSA3 [ICSPA3] -BE2MS1M-I- <input type="checkbox"/> - <input type="checkbox"/> - <input type="checkbox"/> -BNM-T1- <input type="checkbox"/> - <input type="checkbox"/>
		L	ICSA3 [ICSPA3] -BE2MS1L-I- <input type="checkbox"/> - <input type="checkbox"/> - <input type="checkbox"/> -BNM-T1- <input type="checkbox"/> - <input type="checkbox"/>
	3	M	ICSA3 [ICSPA3] -BE3MS1M-I- <input type="checkbox"/> - <input type="checkbox"/> - <input type="checkbox"/> -BNM-T1- <input type="checkbox"/> - <input type="checkbox"/>
		L	ICSA3 [ICSPA3] -BE3MS1L-I- <input type="checkbox"/> - <input type="checkbox"/> - <input type="checkbox"/> -BNM-T1- <input type="checkbox"/> - <input type="checkbox"/>
	4	M	ICSA3 [ICSPA3] -BE4MS1M-I- <input type="checkbox"/> - <input type="checkbox"/> - <input type="checkbox"/> -BNM-T1- <input type="checkbox"/> - <input type="checkbox"/>
		L	ICSA3 [ICSPA3] -BE4MS1L-I- <input type="checkbox"/> - <input type="checkbox"/> - <input type="checkbox"/> -BNM-T1- <input type="checkbox"/> - <input type="checkbox"/>

*1: Refer to the figure below for XY-axis configuration direction.
*2: The load capacity and the maximum speed may vary depending on the type of Z-axis.
Note: T1 in the above models will be T2 when operated with XSEL-P/Q type.

Explanation of Model Code

Number	Contents	Specification
<input type="checkbox"/>	X-axis stroke (Note 1)	30 : 300mm ~ 100 : 1000mm
<input type="checkbox"/>	Y-axis stroke (Note 1)	20 : 200mm ~ 70 : 700mm
<input type="checkbox"/>	Z-axis stroke (Note 1)	10 : 100mm ~ 40 : 400mm
<input type="checkbox"/>	Cable length (Note 2)	3L : 3m 5L : 5m
<input type="checkbox"/>	Y-axis/ Z-axis cable management	SC-SC : Self-standing cable

* The above explains the Models/Specifications chart to the left.

Options

Please add the option codes at the end of each stroke of the axis.
When adding multiple options, put together in alphabetic order.

Name	Code	Page
AQ seal	AQ	P13
Brake	B	P13
Creep sensor	C	P13
Home limit switch	L	P14
Reversed-home specification	NM	P14
Guide with ball-retaining mechanism	RT	P14

Configuration Direction

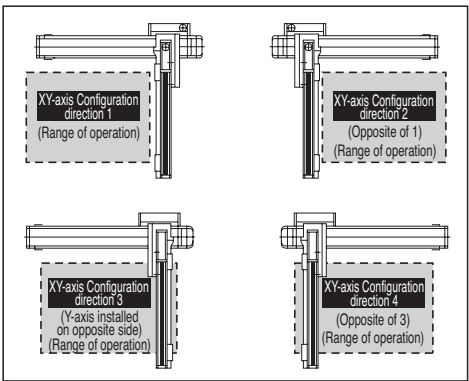

Common Specifications * [] is for the high-precision specification.

Drive system	Ball screw, rolled C10 [equivalent to rolled C5]
Positioning repeatability	±0.02mm [±0.01mm]
Backlash	0.05mm or less [0.02mm or less]
Guide	Integrated with base
Base	Material: Aluminum with white alumite treatment
X-axis motor output / lead	200W / 10mm
Y-axis motor output / lead	200W / 10mm
Z-axis motor output / lead	60W / 8mm (M), 4mm (L)

Applicable Controller Specifications

Refer to page 65 for System Configuration.

Axis Configuration * [] is for the high-precision specification.

Axis Type	Model	Page
X-axis	ISA[ISPA]-LXM- <input type="checkbox"/> -200-10-(Stroke)-T1	P25
Y-axis	ISA[ISPA]-MYM- <input type="checkbox"/> -200-10-(Stroke)-T1	P22
Z-axis	ISA[ISPA]-SZM- <input type="checkbox"/> -60-8/4-(Stroke)-T1-B-NM	P17

* In the above model name, indicates encoder type A (absolute) or I (incremental).

Caution

(Note 1) The stroke in the model is specified in cm (centimeters).
 (Note 2) The cable length measures from the X-axis connector box to the controller. The standard lengths are 3m and 5m, but other lengths can also be specified in meters. The maximum length is 20m.
 (Note 3) The rated acceleration is 0.3G. Increasing the acceleration will result in lower load capacity.
 (Note 4) Please note that a longer stroke will result in a lower maximum speed.

* For other points to note, please refer to page 49.

ICSA3 [ICSPA3] -BE□MS1□

Load Capacity (kg) (Note3)

BE□MS1M

		Y-axis stroke					
		200	300	400	500	600	700
Z-axis stroke	100	3.0					
	200	2.3					
	300	1.6					
	400	0.9					

BE□MS1L

		Y-axis stroke					
		200	300	400	500	600	700
Z-axis stroke	100	11.0					
	200	10.3					
	300	9.6					
	400	8.9					

Maximum Speed by Stroke (mm/sec) (Note4)

BE□MS1M

	Stroke										
	100	200	300	400	500	600	700	800	900	1000	
X-axis	-	-	500					470	385	320	
Y-axis	-	500					480	-	-	-	
Z-axis	400			-	-	-	-	-	-	-	

BE□MS1L

	Stroke										
	100	200	300	400	500	600	700	800	900	1000	
X-axis	-	-	500					470	385	320	
Y-axis	-	500					480	-	-	-	
Z-axis	200			-	-	-	-	-	-	-	

Dimensions * The dimension below is for XY-axis Configuration direction 1.

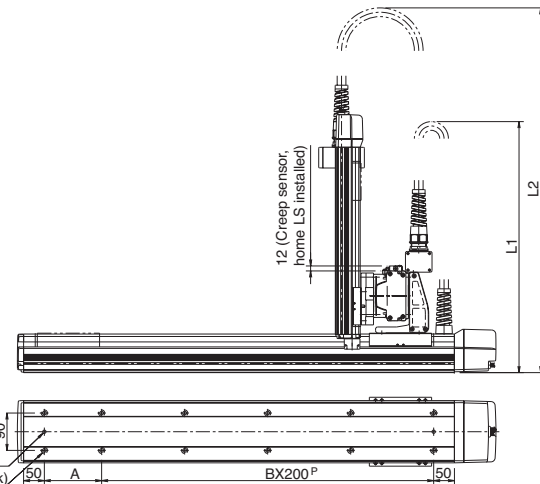
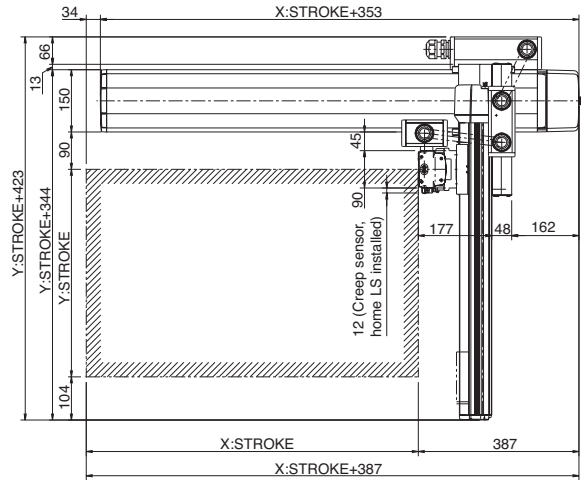
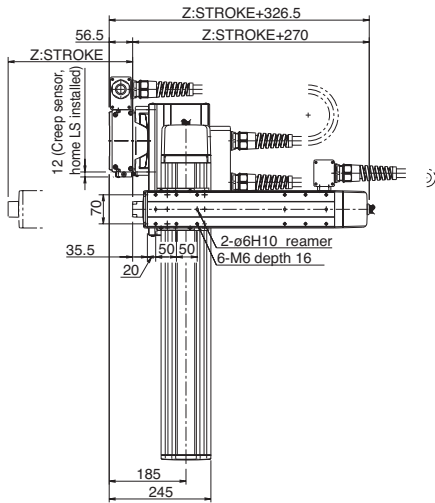

* The configuration position in the figure is home position. To change the home position, indicate NM in the option. Note that changing the home direction will require the actuator to be returned to IAI for adjustment.

X stroke	300	400	500	600	700	800	900	1000
L1	(600)	(650)	(700)	(750)	(800)	(850)	(900)	(950)
A	238	138	238	138	238	138	238	138
B	1	2	2	3	3	4	4	5
C	6	8	8	10	10	12	12	14

		Y stroke					
		200	300	400	500	600	700
Z stroke	100	(700)	(750)	(800)	(850)	(900)	(950)
	200	(800)	(850)	(900)	(950)	(1000)	(1050)
	300	(900)	(950)	(1000)	(1050)	(1100)	(1150)
	400	(1000)	(1050)	(1100)	(1150)	(1200)	(1250)

ICSA3-BE MS3M

Cartesian Robot: X-Y-Z 3-Axes Configuration
Z-Axis Slider Mount Type

ICSPA3-BE MS3M

Cartesian Robot: X-Y-Z 3-Axes Configuration
Z-Axis Slider Mount Type High-Precision Specification



Type XYB + Z-Axis Slider Mount Type **Stroke** X-axis: 300-1000mm Y-axis: 200-700mm Z-axis: 100-400mm **Load capacity** 11.9kg ~ 7.5kg

Model specification items Series - Type - Encoder type - X-axis stroke + options - Y-axis stroke + options - Z-axis stroke + options - Applicable controller - Cable length - Cable management
(Example) ICSA3 (ICSPA3) - BE1MS3M - A - 50AQL - 40AQL - 30BLNM - T1 - 5L - SC-SC

* Refer to page 51 for the details of model specification items.

Models/Specifications * [] is for the high-precision specification.

Encoder Type	XY-axis configuration direction (*1)	Z-axis type (*2)	Model
Absolute	1	M	ICSA3 [ICSPA3] -BE1MS3M-A- <input type="checkbox"/> - <input type="checkbox"/> - <input type="checkbox"/> -BNM-T1- <input type="checkbox"/> - <input type="checkbox"/>
	2	M	ICSA3 [ICSPA3] -BE2MS3M-A- <input type="checkbox"/> - <input type="checkbox"/> - <input type="checkbox"/> -BNM-T1- <input type="checkbox"/> - <input type="checkbox"/>
	3	M	ICSA3 [ICSPA3] -BE3MS3M-A- <input type="checkbox"/> - <input type="checkbox"/> - <input type="checkbox"/> -BNM-T1- <input type="checkbox"/> - <input type="checkbox"/>
	4	M	ICSA3 [ICSPA3] -BE4MS3M-A- <input type="checkbox"/> - <input type="checkbox"/> - <input type="checkbox"/> -BNM-T1- <input type="checkbox"/> - <input type="checkbox"/>
Incremental	1	M	ICSA3 [ICSPA3] -BE1MS3M-I- <input type="checkbox"/> - <input type="checkbox"/> - <input type="checkbox"/> -BNM-T1- <input type="checkbox"/> - <input type="checkbox"/>
	2	M	ICSA3 [ICSPA3] -BE2MS3M-I- <input type="checkbox"/> - <input type="checkbox"/> - <input type="checkbox"/> -BNM-T1- <input type="checkbox"/> - <input type="checkbox"/>
	3	M	ICSA3 [ICSPA3] -BE3MS3M-I- <input type="checkbox"/> - <input type="checkbox"/> - <input type="checkbox"/> -BNM-T1- <input type="checkbox"/> - <input type="checkbox"/>
	4	M	ICSA3 [ICSPA3] -BE4MS3M-I- <input type="checkbox"/> - <input type="checkbox"/> - <input type="checkbox"/> -BNM-T1- <input type="checkbox"/> - <input type="checkbox"/>

*1: Refer to the figure below for XY-axis configuration direction.

*2: The load capacity and the maximum speed may vary depending on the type of Z-axis.

Note: T1 in the above models will be T2 when operated with XSEL-P/Q type.

Explanation of Model Code

Number	Contents	Specification
<input type="checkbox"/>	X-axis stroke (Note 1)	30 : 300mm ~ 100 : 1000mm
<input type="checkbox"/>	Y-axis stroke (Note 1)	20 : 200mm ~ 70 : 700mm
<input type="checkbox"/>	Z-axis stroke (Note 1)	10 : 100mm ~ 40 : 400mm
<input type="checkbox"/>	Cable length (Note 2)	3L : 3m 5L : 5m
<input type="checkbox"/>	Y-axis/ Z-axis cable management	SC-SC : Self-standing cable

* The above explains the Models/Specifications chart to the left.

Options

Please add the option codes at the end of each stroke of the axis. When adding multiple options, put together in alphabetic order.

Name	Code	Page
AQ seal	AQ	P13
Brake	B	P13
Creep sensor	C	P13
Home limit switch	L	P14
Reversed-home specification	NM	P14
Guide with ball-retaining mechanism	RT	P14

Configuration Direction

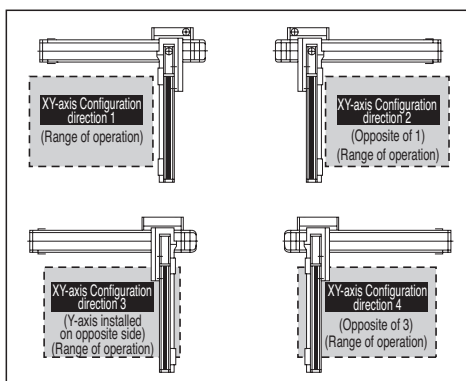

Axis Configuration * [] is for the high-precision specification.

Axis Type	Model	Page
X-axis	ISA[ISPA]-LXM- <input type="checkbox"/> -200-10-(Stroke)-T1	P25
Y-axis	ISA[ISPA]-MYM- <input type="checkbox"/> -200-10-(Stroke)-T1	P22
Z-axis	ISA[ISPA]-MZM- <input type="checkbox"/> -200-10-(Stroke)-T1-B-NM	P24

* In the above model name, indicates encoder type A (absolute) or I (incremental).

Common Specifications * [] is for the high-precision specification.

Drive system	Ball screw, rolled C10 [equivalent to rolled C5]
Positioning repeatability	±0.02mm [±0.01mm]
Backlash	0.05mm or less [0.02mm or less]
Guide	Integrated with base
Base	Material: Aluminum with white alumite treatment
X-axis motor output / lead	200W / 10mm
Y-axis motor output / lead	200W / 10mm
Z-axis motor output / lead	200W / 10mm (M)

Applicable Controller Specifications

Refer to page 65 for System Configuration.



Caution

(Note 1) The stroke in the model is specified in cm (centimeters).

(Note 2) The cable length measures from the X-axis connector box to the controller. The standard lengths are 3m and 5m, but other lengths can also be specified in meters. The maximum length is 20m.

(Note 3) The rated acceleration is 0.3G. Increasing the acceleration will result in lower load capacity.

(Note 4) Please note that a longer stroke will result in a lower maximum speed.

* For other points to note, please refer to page 49.

ICSA3 [ICSPA3] -BE□MS3M

Load Capacity (kg) (Note3)

BE□MS3M

		Y-axis stroke					
		200	300	400	500	600	700
Z-axis stroke	100	11.9					10.5
	200	10.9					9.5
	300	9.9					8.5
	400	8.9					7.5

Maximum Speed by Stroke (mm/sec) (Note4)

BE□MS3M

	Stroke										
	100	200	300	400	500	600	700	800	900	1000	
X-axis	-	-	500					470	385	320	-
Y-axis	-	500					480	-	-	-	-
Z-axis	500			-	-	-	-	-	-	-	

Dimensions * The dimension below is for XY-axis Configuration direction 1.

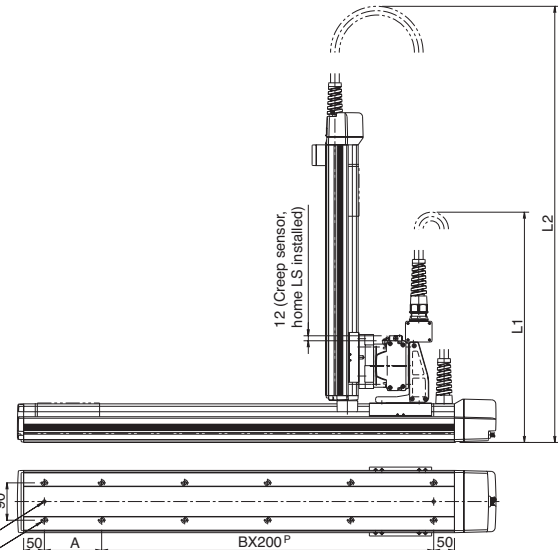
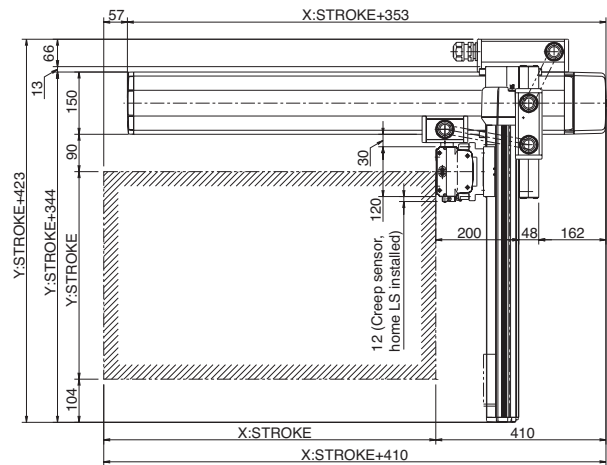
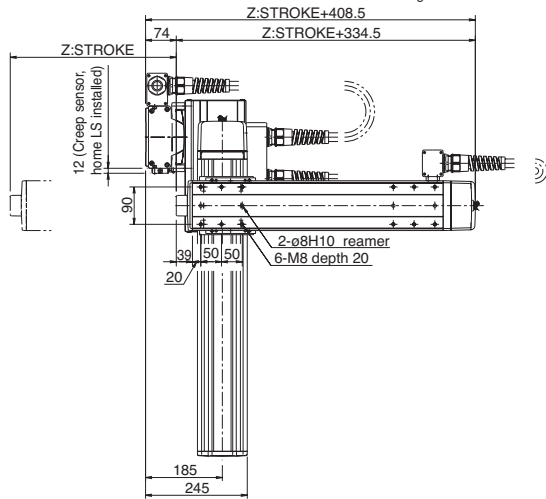

* The configuration position in the figure is home position. To change the home position, indicate NM in the option. Note that changing the home direction will require the actuator to be returned to IA1 for adjustment.

X stroke	300	400	500	600	700	800	900	1000
L1	(600)	(650)	(700)	(750)	(800)	(850)	(900)	(950)
A	238	138	238	138	238	138	238	138
B	1	2	2	3	3	4	4	5
C	6	8	8	10	10	12	12	14

Z stroke	Y stroke						
	200	300	400	500	600	700	
100	(720)	(770)	(820)	(870)	(920)	(970)	
200	(820)	(870)	(920)	(970)	(1020)	(1070)	
300	(920)	(970)	(1020)	(1070)	(1120)	(1170)	
400	(1020)	(1070)	(1120)	(1170)	(1220)	(1270)	

ICSA3-BF **HS1**

Cartesian Robot: X-Y-Z 3-Axes Configuration
Z-Axis Slider Mount Type

ICSPA3-BF **HS1**

Cartesian Robot: X-Y-Z 3-Axes Configuration
Z-Axis Slider Mount Type **High-Precision Specification**

Type XYB + Z-Axis Slider Mount Type Stroke X-axis: 1000-2500mm Y-axis: 200-700mm Z-axis: 100-400mm Load capacity 11kg ~ 0.9kg

Model specification items Series Type Encoder type X-axis stroke + options Y-axis stroke + options Z-axis stroke + options Applicable controller Cable length Cable management
(Example) ICSA3 (ICSPA3) - BF1HS1M - A - 100AQL - 40AQL - 30BLNM - T1 - 5L - CT - SC



* Refer to page 51 for the details of model specification items.

Models/Specifications

* [] is for the high-precision specification.

Encoder Type	XY-axis configuration direction (*1)	Z-axis type (*2)	Model
Absolute	1	M	ICSA3 [ICSPA3] -BF1HS1M-A- <input type="checkbox"/> - <input type="checkbox"/> - <input type="checkbox"/> -BNM-T1- <input type="checkbox"/> - <input type="checkbox"/>
		L	ICSA3 [ICSPA3] -BF1HS1L-A- <input type="checkbox"/> - <input type="checkbox"/> - <input type="checkbox"/> -BNM-T1- <input type="checkbox"/> - <input type="checkbox"/>
	2	M	ICSA3 [ICSPA3] -BF2HS1M-A- <input type="checkbox"/> - <input type="checkbox"/> - <input type="checkbox"/> -BNM-T1- <input type="checkbox"/> - <input type="checkbox"/>
		L	ICSA3 [ICSPA3] -BF2HS1L-A- <input type="checkbox"/> - <input type="checkbox"/> - <input type="checkbox"/> -BNM-T1- <input type="checkbox"/> - <input type="checkbox"/>
	3	M	ICSA3 [ICSPA3] -BF3HS1M-A- <input type="checkbox"/> - <input type="checkbox"/> - <input type="checkbox"/> -BNM-T1- <input type="checkbox"/> - <input type="checkbox"/>
		L	ICSA3 [ICSPA3] -BF3HS1L-A- <input type="checkbox"/> - <input type="checkbox"/> - <input type="checkbox"/> -BNM-T1- <input type="checkbox"/> - <input type="checkbox"/>
	4	M	ICSA3 [ICSPA3] -BF4HS1M-A- <input type="checkbox"/> - <input type="checkbox"/> - <input type="checkbox"/> -BNM-T1- <input type="checkbox"/> - <input type="checkbox"/>
		L	ICSA3 [ICSPA3] -BF4HS1L-A- <input type="checkbox"/> - <input type="checkbox"/> - <input type="checkbox"/> -BNM-T1- <input type="checkbox"/> - <input type="checkbox"/>
Incremental	1	M	ICSA3 [ICSPA3] -BF1HS1M-I- <input type="checkbox"/> - <input type="checkbox"/> - <input type="checkbox"/> -BNM-T1- <input type="checkbox"/> - <input type="checkbox"/>
		L	ICSA3 [ICSPA3] -BF1HS1L-I- <input type="checkbox"/> - <input type="checkbox"/> - <input type="checkbox"/> -BNM-T1- <input type="checkbox"/> - <input type="checkbox"/>
	2	M	ICSA3 [ICSPA3] -BF2HS1M-I- <input type="checkbox"/> - <input type="checkbox"/> - <input type="checkbox"/> -BNM-T1- <input type="checkbox"/> - <input type="checkbox"/>
		L	ICSA3 [ICSPA3] -BF2HS1L-I- <input type="checkbox"/> - <input type="checkbox"/> - <input type="checkbox"/> -BNM-T1- <input type="checkbox"/> - <input type="checkbox"/>
	3	M	ICSA3 [ICSPA3] -BF3HS1M-I- <input type="checkbox"/> - <input type="checkbox"/> - <input type="checkbox"/> -BNM-T1- <input type="checkbox"/> - <input type="checkbox"/>
		L	ICSA3 [ICSPA3] -BF3HS1L-I- <input type="checkbox"/> - <input type="checkbox"/> - <input type="checkbox"/> -BNM-T1- <input type="checkbox"/> - <input type="checkbox"/>
	4	M	ICSA3 [ICSPA3] -BF4HS1M-I- <input type="checkbox"/> - <input type="checkbox"/> - <input type="checkbox"/> -BNM-T1- <input type="checkbox"/> - <input type="checkbox"/>
		L	ICSA3 [ICSPA3] -BF4HS1L-I- <input type="checkbox"/> - <input type="checkbox"/> - <input type="checkbox"/> -BNM-T1- <input type="checkbox"/> - <input type="checkbox"/>

*1: Refer to the figure below for XY-axis configuration direction.

*2: The load capacity and the maximum speed may vary depending on the type of Z-axis.

Note: T1 in the above models will be T2 when operated with XSEL-P/Q type.

Explanation of Model Code

Number	Contents	Specification
<input type="checkbox"/>	X-axis stroke (Note 1)	100 : 1000mm ~ 250 : 2500mm
<input type="checkbox"/>	Y-axis stroke (Note 1)	20 : 200mm ~ 70 : 700mm
<input type="checkbox"/>	Z-axis stroke (Note 1)	10 : 100mm ~ 40 : 400mm
<input type="checkbox"/>	Cable length (Note 2)	3L : 3m 5L : 5m
<input type="checkbox"/>	Y-axis/ Z-axis cable management	CT-SC : Self-standing cable (*3)

* The above explains the Models/Specifications chart to the left.

*3 Only cable track can be specified for the Y-axis cable management with model # BFHS.

Options

Please add the option codes at the end of each stroke of the axis. When adding multiple options, put together in alphabetic order.

Name	Code	Page
AQ seal	AQ	P13
Brake	B	P13
Creep sensor	C	P13
Home limit switch	L	P14
Reversed-home specification	NM	P14
Guide with ball-retaining mechanism	RT	P14

Configuration Direction

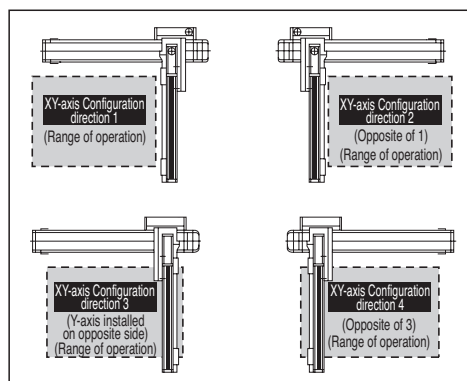

Common Specifications

* [] is for the high-precision specification.

Drive system	Ball screw, rolled C10 [equivalent to rolled C5]
Positioning repeatability	±0.02mm [±0.01mm]
Backlash	0.05mm or less [0.02mm or less]
Guide	Integrated with base
Base	Material: Aluminum with white alumite treatment
X-axis motor output / lead	400W / 20mm
Y-axis motor output / lead	200W / 20mm
Z-axis motor output / lead	60W / 8mm (M), 4mm (L)

Applicable Controller Specifications

Refer to page 65 for System Configuration.

Axis Configuration

* [] is for the high-precision specification.

Axis Type	Model	Page
X-axis	ISA[ISPA]-LXMX- <input type="checkbox"/> -400-20-(Stroke)-T1	P28
Y-axis	ISA[ISPA]-MYM- <input type="checkbox"/> -200-20-(Stroke)-T1	P22
Z-axis	ISA[ISPA]-SZM- <input type="checkbox"/> -60-8/4-(Stroke)-T1-B-NM	P17

* In the above model name, indicates encoder type A (absolute) or I (incremental).



Caution

(Note 1) The stroke in the model is specified in cm (centimeters).

(Note 2) The cable length measures from the X-axis connector box to the controller. The standard lengths are 3m and 5m, but other lengths can also be specified in meters. The maximum length is 20m.

(Note 3) The rated acceleration is 0.3G. Increasing the acceleration will result in lower load capacity.

(Note 4) Please note that a longer stroke will result in a lower maximum speed.

* For other points to note, please refer to page 49.

ICSA3 [ICSPA3] -BF□HS1□

Load Capacity (kg) (Note3)

BF□HS1M

		Y-axis stroke					
		200	300	400	500	600	700
Z-axis stroke	100	3.0					
	200	2.3					
	300	1.6					
	400	0.9					

BF□HS1L

		Y-axis stroke					
		200	300	400	500	600	700
Z-axis stroke	100	11.0					
	200	10.3					
	300	9.6					
	400	8.9					

Maximum Speed by Stroke (mm/sec) (Note4)

BF□HS1M

	Stroke																
	100	200~400	500	600	700	1000~1400	1500	1600	1700	1800	1900	2000	2100	2200	2300	2400	2500
X-axis	-	-	-	-	-	1000	950	830	740	650	590	540	490	440	410	370	300
Y-axis	1000						-	-	-	-	-	-	-	-	-	-	-
Z-axis	400	-	-	-	-	-	-	-	-	-	-	-	-	-	-	-	-

BF□HS1L

	Stroke																
	100	200~400	500	600	700	1000~1400	1500	1600	1700	1800	1900	2000	2100	2200	2300	2400	2500
X-axis	-	-	-	-	-	1000	950	830	740	650	590	540	490	440	410	370	300
Y-axis	1000						-	-	-	-	-	-	-	-	-	-	-
Z-axis	200	-	-	-	-	-	-	-	-	-	-	-	-	-	-	-	-

Dimensions

* The dimension below is for XY-axis Configuration direction 1.

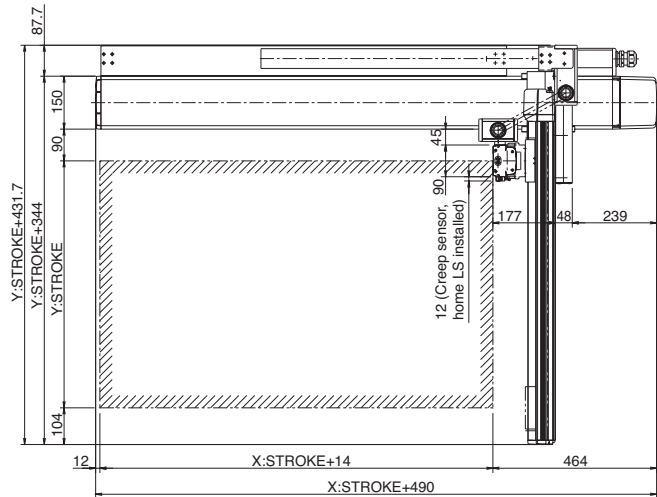
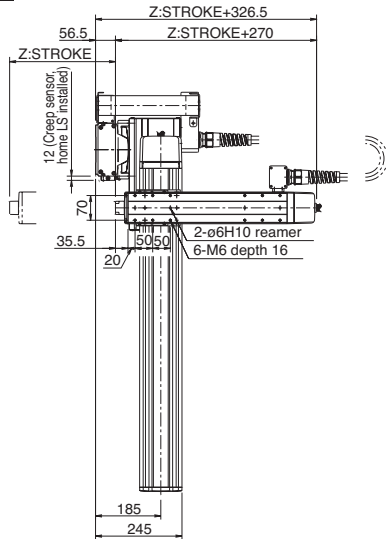

* The configuration position in the figure is home position. To change the home position, indicate NM in the option. Note that changing the home direction will require the actuator to be returned to IAI for adjustment.

X st	A	B	C	D
1000	225	0	0	12
1100	275	0	0	12
1200	325	0	0	12
1300	375	0	0	12
1400	425	0	0	12
1500	475	0	0	12
1600	525	0	0	12
1700	575	0	0	12
1800	200	425	0	16
1900	200	475	0	16
2000	200	525	0	16
2100	200	575	0	16
2200	200	200	425	20
2300	200	200	475	20
2400	200	200	525	20
2500	200	200	575	20

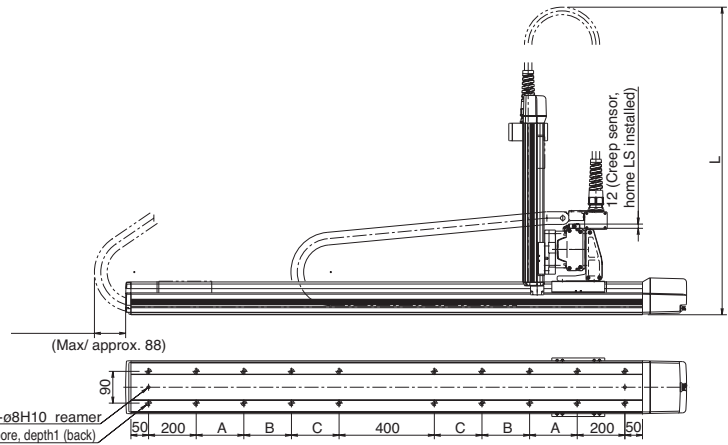

		Y stroke					
		200	300	400	500	600	700
Z stroke	100	(700)	(750)	(800)	(850)	(900)	(950)
	200	(800)	(850)	(900)	(950)	(1000)	(1050)
	300	(900)	(950)	(1000)	(1050)	(1100)	(1150)
	400	(1000)	(1050)	(1100)	(1150)	(1200)	(1250)

ICSA3-BF □ HS3M

Cartesian Robot: X-Y-Z 3-Axes Configuration
Z-Axis Slider Mount Type

ICSPA3-BF □ HS3M

Cartesian Robot: X-Y-Z 3-Axes Configuration
Z-Axis Slider Mount Type **High-Precision Specification**

Type XYB + Z-Axis Slider Mount Type Stroke X-axis: 1000-2500mm Y-axis: 200-700mm Z-axis: 100-400mm Load capacity 11.9kg ~ 7.5kg

Model specification items	Series	Type	Encoder type	X-axis stroke + options	Y-axis stroke + options	Z-axis stroke + options	Applicable controller	Cable length	Cable management
(Example)	ICSA3 [ICSPA3]	BFHS3M	A	100AQL	40AQL	30BLNM	T1	5L	CT-SC

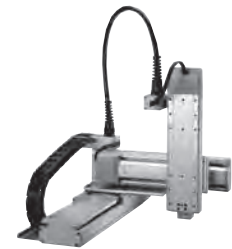

* Refer to page 51 for the details of model specification items.

Models/Specifications

* [] is for the high-precision specification.

Encoder Type	XY-axis configuration direction (*1)	Z-axis type (*2)	Model
Absolute	1	M	ICSA3 [ICSPA3] -BF1HS3M-A- [①] - [②] - [③] -BNM-T1- [④] - [⑤]
	2	M	ICSA3 [ICSPA3] -BF2HS3M-A- [①] - [②] - [③] -BNM-T1- [④] - [⑤]
	3	M	ICSA3 [ICSPA3] -BF3HS3M-A- [①] - [②] - [③] -BNM-T1- [④] - [⑤]
	4	M	ICSA3 [ICSPA3] -BF4HS3M-A- [①] - [②] - [③] -BNM-T1- [④] - [⑤]
Incremental	1	M	ICSA3 [ICSPA3] -BF1HS3M-I- [①] - [②] - [③] -BNM-T1- [④] - [⑤]
	2	M	ICSA3 [ICSPA3] -BF2HS3M-I- [①] - [②] - [③] -BNM-T1- [④] - [⑤]
	3	M	ICSA3 [ICSPA3] -BF3HS3M-I- [①] - [②] - [③] -BNM-T1- [④] - [⑤]
	4	M	ICSA3 [ICSPA3] -BF4HS3M-I- [①] - [②] - [③] -BNM-T1- [④] - [⑤]

*1: Refer to the figure below for XY-axis configuration direction.

*2: The load capacity and the maximum speed may vary depending on the type of Z-axis.
Note: T1 in the above models will be T2 when operated with XSEL-P/Q type.

Explanation of Model Code

Number	Contents	Specification
①	X-axis stroke (Note 1)	100 : 1000mm ~ 250 : 2500mm
②	Y-axis stroke (Note 1)	20 : 200mm ~ 70 : 700mm
③	Z-axis stroke (Note 1)	10 : 100mm ~ 40 : 400mm
④	Cable length (Note 2)	3L : 3m 5L : 5m
⑤	Y-axis/ Z-axis cable management	CT-SC : Self-standing cable (*3)

* The above explains the Models/Specifications chart to the left.

*3 Only cable track can be specified for the Y-axis cable management with model # BF□HS3□.

Options

Please add the option codes at the end of each stroke of the axis.
When adding multiple options, put together in alphabetic order.

Name	Code	Page
AQ seal	AQ	P13
Brake	B	P13
Creep sensor	C	P13
Home limit switch	L	P14
Reversed-home specification	NM	P14
Guide with ball-retaining mechanism	RT	P14

Configuration Direction

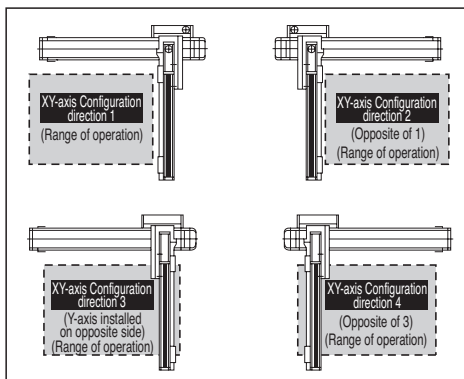

Axis Configuration

* [] is for the high-precision specification.

Axis Type	Model	Page
X-axis	ISA[ISPA]-LXMX-□-400-20-(Stroke)-T1	P28
Y-axis	ISA[ISPA]-MYM-□-200-20-(Stroke)-T1	P22
Z-axis	ISA[ISPA]-MZM-□-200-10-(Stroke)-T1-B-NM	P24

* In the above model name, □ indicates encoder type A (absolute) or I (incremental).

Common Specifications

* [] is for the high-precision specification.

Drive system	Ball screw, rolled C10 [equivalent to rolled C5]
Positioning repeatability	±0.02mm [±0.01mm]
Backlash	0.05mm or less [0.02mm or less]
Guide	Integrated with base
Base	Material: Aluminum with white alumite treatment
X-axis motor output / lead	400W / 20mm
Y-axis motor output / lead	200W / 20mm
Z-axis motor output / lead	200W / 10mm

Applicable Controller Specifications

Refer to page 65 for System Configuration.



Caution

- (Note 1) The stroke in the model is specified in cm (centimeters).
- (Note 2) The cable length measures from the X-axis connector box to the controller. The standard lengths are 3m and 5m, but other lengths can also be specified in meters. The maximum length is 20m.
- (Note 3) The rated acceleration is 0.3G. Increasing the acceleration will result in lower load capacity.
- (Note 4) Please note that a longer stroke will result in a lower maximum speed.

* For other points to note, please refer to page 49.

ICSA3 [ICSPA3] -BF□HS3M

Load Capacity (kg) (Note3)

BF□HS3M

		Y-axis stroke					
		200	300	400	500	600	700
Z-axis stroke	100	11.9				10.5	
	200	10.9				9.5	
	300	9.9				8.5	
	400	8.9				7.5	

Maximum Speed by Stroke (mm/sec) (Note4)

BF□HS3M

	Stroke															
	100	200~400	500~700	1000~1400	1500	1600	1700	1800	1900	2000	2100	2200	2300	2400	2500	
X-axis	-	-	-	1000	950	830	740	650	590	540	490	440	410	370	300	
Y-axis	-	1000		-	-	-	-	-	-	-	-	-	-	-	-	
Z-axis	500		-	-	-	-	-	-	-	-	-	-	-	-	-	

Dimensions * The dimension below is for XY-axis Configuration direction 1.

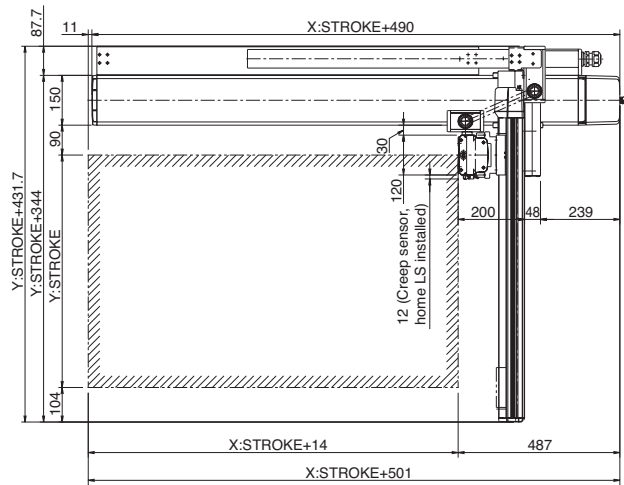
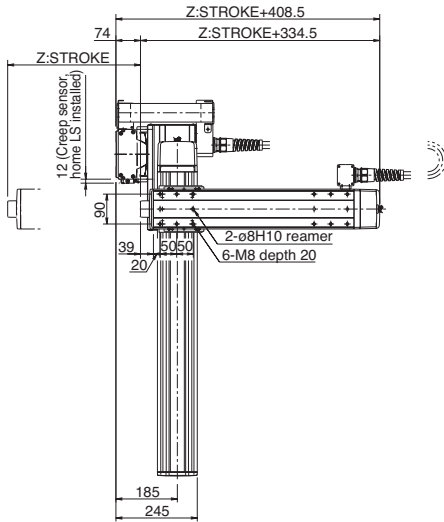

* The configuration position in the figure is home position. To change the home position, indicate NM in the option. Note that changing the home direction will require the actuator to be returned to IAI for adjustment.

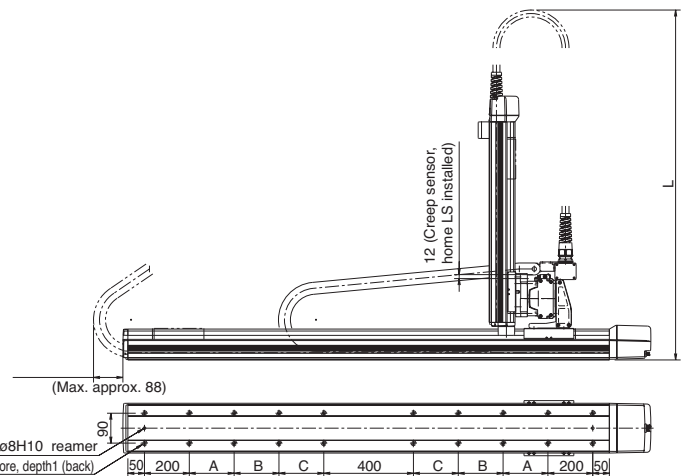

X st	A	B	C	D
1000	225	0	0	12
1100	275	0	0	12
1200	325	0	0	12
1300	375	0	0	12
1400	425	0	0	12
1500	475	0	0	12
1600	525	0	0	12
1700	575	0	0	12
1800	200	425	0	16
1900	200	475	0	16
2000	200	525	0	16
2100	200	575	0	16
2200	200	200	425	20
2300	200	200	475	20
2400	200	200	525	20
2500	200	200	575	20

		Y stroke					
		200	300	400	500	600	700
Z stroke	100	(680)	(730)	(780)	(830)	(880)	(930)
	200	(780)	(830)	(880)	(930)	(980)	(1030)
	300	(880)	(930)	(980)	(1030)	(1080)	(1130)
	400	(980)	(1030)	(1080)	(1130)	(1180)	(1230)

ICSA3-G1JHB1 □

Cartesian Robot: X-Y-Z 3-Axes Configuration
Z-Axis Base Mount Type

ICSPA3-G1JHB1 □

Cartesian Robot: X-Y-Z 3-Axes Configuration
Z-Axis Base Mount Type High-Precision Specification

Type XYG + Z-Axis Base Mount Type Stroke X-axis: 1000-2500mm Y-axis: 500-700mm Z-axis: 100-600mm Load capacity 14kg ~ 3kg

Model specification items Series - Type - Encoder type - X-axis stroke + options - Y-axis stroke + options - Z-axis stroke + options - Applicable controller - Cable length - Cable management
(Example) ICSA3 (ICSPA3) - G1JHB1H - A - 100AQL - 50AQL - 30BL - T1 - 5L - CT-SC

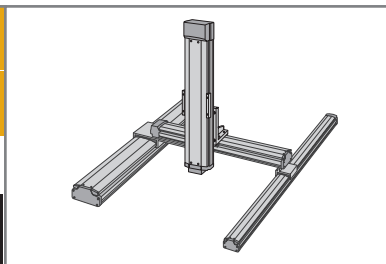

* Refer to page 51 for the details of model specification items.

Models/Specifications * [] is for the high-precision specification.

Encoder Type	XY-axis configuration direction	Z-axis type (*1)	Model
Absolute	-	H	ICSA3 [ICSPA3] -G1JHB1H-A- [1]- [2]- [3]-B-T1- [4]- [5]
		M	ICSA3 [ICSPA3] -G1JHB1M-A- [1]- [2]- [3]-B-T1- [4]- [5]
		L	ICSA3 [ICSPA3] -G1JHB1L-A- [1]- [2]- [3]-B-T1- [4]- [5]
Incremental	-	H	ICSA3 [ICSPA3] -G1JHB1H-I- [1]- [2]- [3]-B-T1- [4]- [5]
		M	ICSA3 [ICSPA3] -G1JHB1M-I- [1]- [2]- [3]-B-T1- [4]- [5]
		L	ICSA3 [ICSPA3] -G1JHB1L-I- [1]- [2]- [3]-B-T1- [4]- [5]

*1: The load capacity and the maximum speed may vary depending on the type of Z-axis.
Note: T1 in the above models will be T2 when operated with XSEL-P/Q type.

Explanation of Model Code

Number	Contents	Specification
①	X-axis stroke (Note 1)	100 : 1000mm ~ 250 : 2500mm
②	Y-axis stroke (Note 1)	50 : 500mm ~ 70 : 700mm
③	Z-axis stroke (Note 1)	10 : 100mm ~ 60 : 600mm
④	Cable length (Note 2)	3L : 3m 5L : 5m
⑤	Y-axis/ Z-axis cable management	CT-SC : Self-standing cable (*2) CT-CT : Cable track

* The above explains the Models/Specifications chart to the left.
*2 Only cable track can be specified for the Y-axis cable management with model # G1JHB1□.

Options

Please add the option codes at the end of each stroke of the axis.
When adding multiple options, put together in alphabetic order.

Name	Code	Page
AQ seal	AQ	P13
Brake	B	P13
Creep sensor	C	P13
Home limit switch	L	P14
Reversed-home specification	NM	P14
Guide with ball-retaining mechanism	RT	P14

Common Specifications * [] is for the high-precision specification.

Drive system	Ball screw, rolled C10 [equivalent to rolled C5]
Positioning repeatability	±0.02mm [±0.01mm]
Backlash	0.05mm or less [0.02mm or less]
Guide	Integrated with base
Base	Material: Aluminum with white alumite treatment
X-axis motor output / lead	400W / 20mm
Y-axis motor output / lead	200W / 20mm
Z-axis motor output / lead	60W / 16mm (H), 8mm (M), 4mm (L)

Applicable Controller Specifications

Refer to page 65 for System Configuration.

Axis Configuration * [] is for the high-precision specification.

Axis Type	Model	Page
X-axis	ISA[ISPA]-LXUWX-□-400-20-(Stroke)-T1	P30
Y-axis	ISA[ISPA]-MXM-□-200-20-(Stroke)-T1	P19
Z-axis	ISA[ISPA]-SXM-□-60-16/8/4-(Stroke)-T1-B	P15

* In the above model name, □ indicates encoder type A (absolute) or I (incremental).

Caution

(Note 1) The stroke in the model is specified in cm (centimeters).
 (Note 2) The cable length measures from the X-axis connector box to the controller. The standard lengths are 3m and 5m, but other lengths can also be specified in meters. The maximum length is 20m.
 (Note 3) The rated acceleration is 0.3G. Increasing the acceleration will result in lower load capacity.
 (Note 4) Please note that a longer stroke will result in a lower maximum speed.

* For other points to note, please refer to page 49.

ICSA3 [ICSPA3] -G1JHB1□

Load Capacity (kg) (Note3)

G1JHB1H

		Y-axis stroke		
		500	600	700
Z-axis stroke	100	3.0		
	200	3.0		
	300	3.0		
	400	3.0		
	500	3.0		
	600	3.0		

G1JHB1M

		Y-axis stroke		
		500	600	700
Z-axis stroke	100	6.0		
	200	6.0		
	300	6.0		
	400	6.0		
	500	6.0		
	600	6.0		

G1JHB1L

		Y-axis stroke		
		500	600	700
Z-axis stroke	100	14.0		
	200	14.0		
	300	14.0		
	400	14.0		
	500	14.0		
	600	14.0		

Maximum Speed by Stroke (mm/sec) (Note4)

G1JHB1H

	Stroke															
	100~400	500	600	700	1000~1400	1500	1600	1700	1800	1900	2000	2100	2200	2300	2400	2500
X-axis	-	-	-	-	1000	950	830	740	650	590	540	490	440	410	370	300
Y-axis	-				1000	-	-	-	-	-	-	-	-	-	-	-
Z-axis	800				-	-	-	-	-	-	-	-	-	-	-	-

G1JHB1M

	Stroke															
	100~400	500	600	700	1000~1400	1500	1600	1700	1800	1900	2000	2100	2200	2300	2400	2500
X-axis	-	-	-	-	1000	950	830	740	650	590	540	490	440	410	370	300
Y-axis	-				1000	-	-	-	-	-	-	-	-	-	-	-
Z-axis	400				-	-	-	-	-	-	-	-	-	-	-	-

G1JHB1L

	Stroke															
	100~400	500	600	700	1000~1400	1500	1600	1700	1800	1900	2000	2100	2200	2300	2400	2500
X-axis	-	-	-	-	1000	950	830	740	650	590	540	490	440	410	370	300
Y-axis	-				1000	-	-	-	-	-	-	-	-	-	-	-
Z-axis	200				-	-	-	-	-	-	-	-	-	-	-	-

Dimensions

* The configuration position in the figure is home position. To change the home position, indicate NM in the option. Note that changing the home direction will require the actuator to be returned to IA for adjustment.

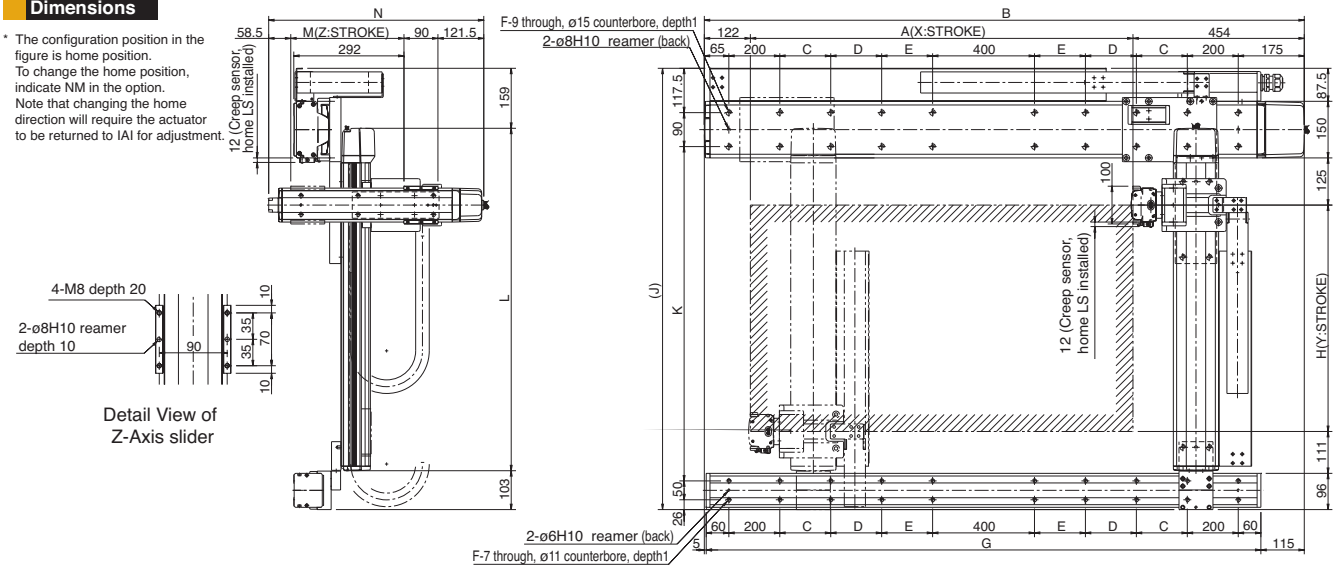

X dimension

A	B	C	D	E	F	G
1014	1590	275	0	0	12	1470
1114	1690	325	0	0	12	1570
1214	1790	375	0	0	12	1670
1314	1890	425	0	0	12	1770
1414	1990	475	0	0	12	1870
1514	2090	525	0	0	12	1970
1614	2190	575	0	0	12	2070
1714	2290	200	425	0	16	2170
1814	2390	200	475	0	16	2270
1914	2490	200	525	0	16	2370
2014	2590	200	575	0	16	2470
2114	2690	200	200	425	20	2570
2214	2790	200	200	475	20	2670
2314	2890	200	200	525	20	2770
2414	2990	200	200	575	20	2870
2514	3090	200	200	625	20	2970

Y dimension

H	J	K	L
500	1069.5	786	807.5
600	1169.5	886	907.5
700	1269.5	986	1007.5

Z dimension

M	N
100	370
200	470
300	570
400	670
500	770
600	870

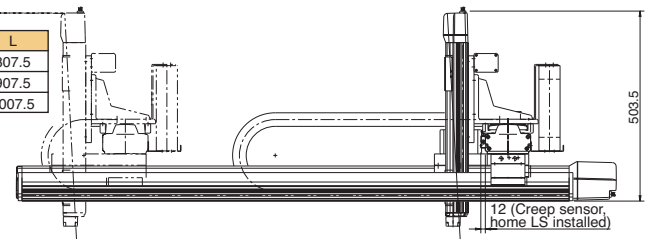

ICSA3-G1JHB2

Cartesian Robot: X-Y-Z 3-Axes Configuration
Z-Axis Base Mount Type

ICSPA3-G1JHB2

Cartesian Robot: X-Y-Z 3-Axes Configuration
Z-Axis Base Mount Type **High-Precision Specification**

Type XYG + Z-Axis Base Mount Type **Stroke** X-axis: 1000-2500mm Y-axis: 500-700mm Z-axis: 100-600mm **Load capacity** 19kg ~ 3.5kg

Model specification items
(Example) ICSA3 (ICSPA3) - G1JHB2H - A - 100AQL - 50AQL - 30BL - T1 - 5L - CT - SC

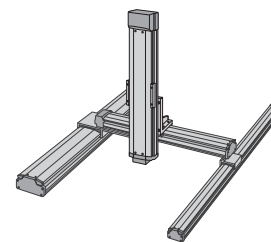

* Refer to page 51 for the details of model specification items.

Models/Specifications

Encoder Type	XY-axis configuration direction	Z-axis type (*1)	Model
Absolute	-	H	ICSA3 [ICSPA3] -G1JHB2H-A-①-②-③-B-T1-④-⑤
		M	ICSA3 [ICSPA3] -G1JHB2M-A-①-②-③-B-T1-④-⑤
		L	ICSA3 [ICSPA3] -G1JHB2L-A-①-②-③-B-T1-④-⑤
Incremental	-	H	ICSA3 [ICSPA3] -G1JHB2H-I-①-②-③-B-T1-④-⑤
		M	ICSA3 [ICSPA3] -G1JHB2M-I-①-②-③-B-T1-④-⑤
		L	ICSA3 [ICSPA3] -G1JHB2L-I-①-②-③-B-T1-④-⑤

*1: The load capacity and the maximum speed may vary depending on the type of Z-axis.
Note: T1 in the above models will be T2 when operated with XSEL-P/Q type.

Explanation of Model Code

Number	Contents	Specification
①	X-axis stroke (Note 1)	100 : 1000mm ~ 250 : 2500mm
②	Y-axis stroke (Note 1)	50 : 500mm ~ 70 : 700mm
③	Z-axis stroke (Note 1)	10 : 100mm ~ 60 : 600mm
④	Cable length (Note 2)	3L : 3m 5L : 5m
⑤	Y-axis/ Z-axis cable management	CT-SC : Self-standing cable (*2) CT-CT : Cable track

* The above explains the Models/Specifications chart to the left.
*2 Only cable track can be specified for the Y-axis cable management with model # G1JHB2□.

Options

Please add the option codes at the end of each stroke of the axis.
When adding multiple options, put together in alphabetic order.

Name	Code	Page
AQ seal	AQ	P13
Brake	B	P13
Creep sensor	C	P13
Home limit switch	L	P14
Reversed-home specification	NM	P14
Guide with ball-retaining mechanism	RT	P14

Common Specifications

Drive system	Ball screw, rolled C10 [equivalent to rolled C5]
Positioning repeatability	±0.02mm [±0.01mm]
Backlash	0.05mm or less [0.02mm or less]
Guide	Integrated with base
Base	Material: Aluminum with white alumite treatment
X-axis motor output / lead	400W / 20mm
Y-axis motor output / lead	200W / 20mm
Z-axis motor output / lead	100W / 20mm (H), 10mm (M), 5mm (L)

Applicable Controller Specifications

Refer to page 65 for System Configuration.

Axis Configuration

Axis Type	Model	Page
X-axis	ISA[ISPA]-LXUWX-□-400-20-(Stroke)-T1	P30
Y-axis	ISA[ISPA]-MXM-□-200-20-(Stroke)-T1	P19
Z-axis	ISA[ISPA]-MXM-□-100-20/10/5-(Stroke)-T1-B	P18

*In the above model name, □ indicates encoder type A (absolute) or I (incremental).



Caution

(Note 1) The stroke in the model is specified in cm (centimeters).
(Note 2) The cable length measures from the X-axis connector box to the controller. The standard lengths are 3m and 5m, but other lengths can also be specified in meters. The maximum length is 20m.
(Note 3) The rated acceleration is 0.3G. Increasing the acceleration will result in lower load capacity.
(Note 4) Please note that a longer stroke will result in a lower maximum speed.

* For other points to note, please refer to page 49.

ICSA3 [ICSPA3] -G1JHB2□

Load Capacity (kg) (Note3)

G1JHB2H

		Y-axis stroke		
		500	600	700
Z-axis stroke	100	3.5		
	200	3.5		
	300	3.5		
	400	3.5		
	500	3.5		
	600	3.5		

G1JHB2M

		Y-axis stroke		
		500	600	700
Z-axis stroke	100	9.0		
	200	9.0		
	300	9.0		
	400	9.0		
	500	9.0		
	600	9.0		

G1JHB2L

		Y-axis stroke		
		500	600	700
Z-axis stroke	100	19.0		
	200	19.0		
	300	19.0		
	400	19.0		
	500	18.8		
	600	17.8		

Maximum Speed by Stroke (mm/sec) (Note4)

G1JHB2H

	Stroke															
	100~400	500	600	700	1000~1400	1500	1600	1700	1800	1900	2000	2100	2200	2300	2400	2500
X-axis	-	-	-	-	1000	950	830	740	650	590	540	490	440	410	370	300
Y-axis	1000				-	-	-	-	-	-	-	-	-	-	-	-
Z-axis	1000				-	-	-	-	-	-	-	-	-	-	-	-

G1JHB2M

	Stroke															
	100~400	500	600	700	1000~1400	1500	1600	1700	1800	1900	2000	2100	2200	2300	2400	2500
X-axis	-	-	-	-	1000	950	830	740	650	590	540	490	440	410	370	300
Y-axis	1000				-	-	-	-	-	-	-	-	-	-	-	-
Z-axis	500				-	-	-	-	-	-	-	-	-	-	-	-

G1JHB2L

	Stroke															
	100~400	500	600	700	1000~1400	1500	1600	1700	1800	1900	2000	2100	2200	2300	2400	2500
X-axis	-	-	-	-	1000	950	830	740	650	590	540	490	440	410	370	300
Y-axis	1000				-	-	-	-	-	-	-	-	-	-	-	-
Z-axis	250				-	-	-	-	-	-	-	-	-	-	-	-

Dimensions

* The configuration position in the figure is home position.
To change the home position, indicate NM in the option.
Note that changing the home direction will require the actuator to be returned to IAI for adjustment.

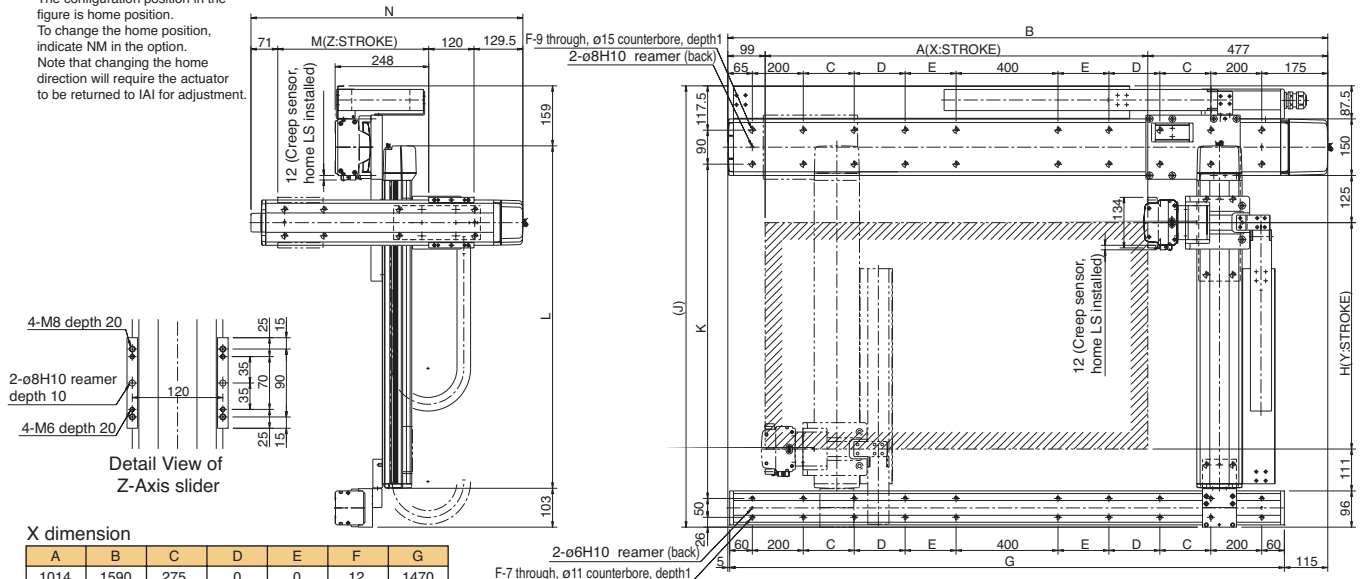

X dimension

A	B	C	D	E	F	G
1014	1590	275	0	0	12	1470
1114	1690	325	0	0	12	1570
1214	1790	375	0	0	12	1670
1314	1890	425	0	0	12	1770
1414	1990	475	0	0	12	1870
1514	2090	525	0	0	12	1970
1614	2190	575	0	0	12	2070
1714	2290	200	425	0	16	2170
1814	2390	200	475	0	16	2270
1914	2490	200	525	0	16	2370
2014	2590	200	575	0	16	2470
2114	2690	200	200	425	20	2570
2214	2790	200	200	475	20	2670
2314	2890	200	200	525	20	2770
2414	2990	200	200	575	20	2870
2514	3090	200	200	625	20	2970

Y dimension

H	J	K	L
500	1069.5	786	807.5
600	1169.5	886	907.5
700	1269.5	986	1007.5

Z dimension

M	N(100W)	N(200W)
100	420.5	434.5
200	520.5	534.5
300	620.5	634.5
400	720.5	734.5
500	820.5	834.5
600	920.5	934.5

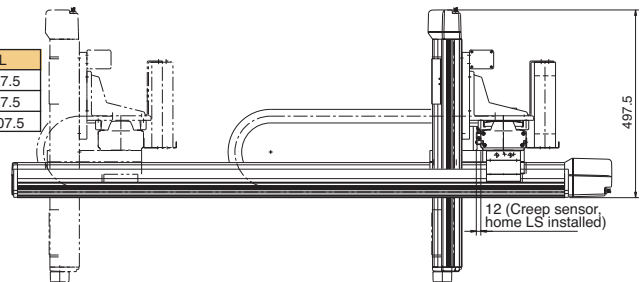

ICSA3-G1JHB3

Cartesian Robot: X-Y-Z 3-Axes Configuration
Z-Axis Base Mount Type

ICSPA3-G1JHB3

Cartesian Robot: X-Y-Z 3-Axes Configuration
Z-Axis Base Mount Type High-Precision Specification

Type XYG + Z-Axis Base Mount Type Stroke X-axis: 1000-2500mm Y-axis: 500-700mm Z-axis: 100-600mm Load capacity 19kg ~ 9kg

Model specification items Series - Type - Encoder type - X-axis stroke + options - Y-axis stroke + options - Z-axis stroke + options - Applicable controller - Cable length - Cable management
(Example) ICSA3 (ICSPA3) - G1JHB3H - A - 100AQL - 50AQL - 30BL - T1 - 5L - CT-SC

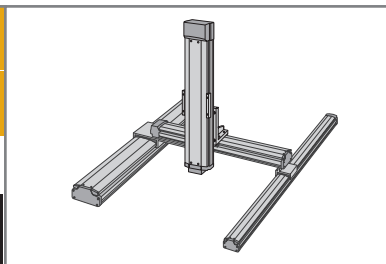

* Refer to page 51 for the details of model specification items.

Models/Specifications

* [] is for the high-precision specification.

Encoder Type	XY-axis configuration direction	Z-axis type (*1)	Model
Absolute	-	H	ICSA3 [ICSPA3] -G1JHB3H-A-[1]-[2]-[3]-B-T1-[4]-[5]
		M	ICSA3 [ICSPA3] -G1JHB3M-A-[1]-[2]-[3]-B-T1-[4]-[5]
		L	ICSA3 [ICSPA3] -G1JHB3L-A-[1]-[2]-[3]-B-T1-[4]-[5]
Incremental	-	H	ICSA3 [ICSPA3] -G1JHB3H-I-[1]-[2]-[3]-B-T1-[4]-[5]
		M	ICSA3 [ICSPA3] -G1JHB3M-I-[1]-[2]-[3]-B-T1-[4]-[5]
		L	ICSA3 [ICSPA3] -G1JHB3L-I-[1]-[2]-[3]-B-T1-[4]-[5]

*1: The load capacity and the maximum speed may vary depending on the type of Z-axis.
Note: T1 in the above models will be T2 when operated with XSEL-P/Q type.

Explanation of Model Code

Number	Contents	Specification
①	X-axis stroke (Note 1)	100 : 1000mm ~ 250 : 2500mm
②	Y-axis stroke (Note 1)	50 : 500mm ~ 70 : 700mm
③	Z-axis stroke (Note 1)	10 : 100mm ~ 60 : 600mm
④	Cable length (Note 2)	3L : 3m 5L : 5m
⑤	Y-axis/ Z-axis cable management	CT-SC : Self-standing cable (*2) CT-CT : Cable track

* The above explains the Models/Specifications chart to the left.
*2 Only cable track can be specified for the Y-axis cable management with model # G1JHB3□.

Options

Please add the option codes at the end of each stroke of the axis.
When adding multiple options, put together in alphabetic order.

Name	Code	Page
AQ seal	AQ	P13
Brake	B	P13
Creep sensor	C	P13
Home limit switch	L	P14
Reversed-home specification	NM	P14
Guide with ball-retaining mechanism	RT	P14

Common Specifications

* [] is for the high-precision specification.

Drive system	Ball screw, rolled C10 [equivalent to rolled C5]
Positioning repeatability	±0.02mm [±0.01mm]
Backlash	0.05mm or less [0.02mm or less]
Guide	Integrated with base
Base	Material: Aluminum with white alumite treatment
X-axis motor output / lead	400W / 20mm
Y-axis motor output / lead	200W / 20mm
Z-axis motor output / lead	200W / 20mm (H), 10mm (M)

Applicable Controller Specifications

Refer to page 65 for System Configuration.

Axis Configuration

* [] is for the high-precision specification.

Axis Type	Model	Page
X-axis	ISA[ISPA]-LXUWX-□-400-20-(Stroke)-T1	P30
Y-axis	ISA[ISPA]-MXM-□-200-20-(Stroke)-T1	P19
Z-axis	ISA[ISPA]-MXM-□-200-20/10-(Stroke)-T1-B	P19

* In the above model name, □ indicates encoder type A (absolute) or I (incremental).

Caution

(Note 1) The stroke in the model is specified in cm (centimeters).
 (Note 2) The cable length measures from the X-axis connector box to the controller. The standard lengths are 3m and 5m, but other lengths can also be specified in meters. The maximum length is 20m.
 (Note 3) The rated acceleration is 0.3G. Increasing the acceleration will result in lower load capacity.
 (Note 4) Please note that a longer stroke will result in a lower maximum speed.

* For other points to note, please refer to page 49.

ICSA3 [ICSPA3] -G1JHB3□

Load Capacity (kg) (Note3)

G1JHB3H

Z-axis stroke	Y-axis stroke		
	500	600	700
100	9.0		
200	9.0		
300	9.0		
400	9.0		
500	9.0		
600	9.0		

G1JHB3M

Z-axis stroke	Y-axis stroke		
	500	600	700
100	19.0		
200	19.0		
300	19.0		
400	18.7		
500	17.6		
600	16.6		

Maximum Speed by Stroke (mm/sec) (Note4)

G1JHB3H

	Stroke															
	100~400	500	600	700	1000~1400	1500	1600	1700	1800	1900	2000	2100	2200	2300	2400	2500
X-axis	-	-	-	-	1000	950	830	740	650	590	540	490	440	410	370	300
Y-axis	1000				-	-	-	-	-	-	-	-	-	-	-	-
Z-axis	1000				-	-	-	-	-	-	-	-	-	-	-	-

G1JHB3M

	Stroke															
	100~400	500	600	700	1000~1400	1500	1600	1700	1800	1900	2000	2100	2200	2300	2400	2500
X-axis	-	-	-	-	1000	950	830	740	650	590	540	490	440	410	370	300
Y-axis	1000				-	-	-	-	-	-	-	-	-	-	-	-
Z-axis	500				-	-	-	-	-	-	-	-	-	-	-	-

Dimensions

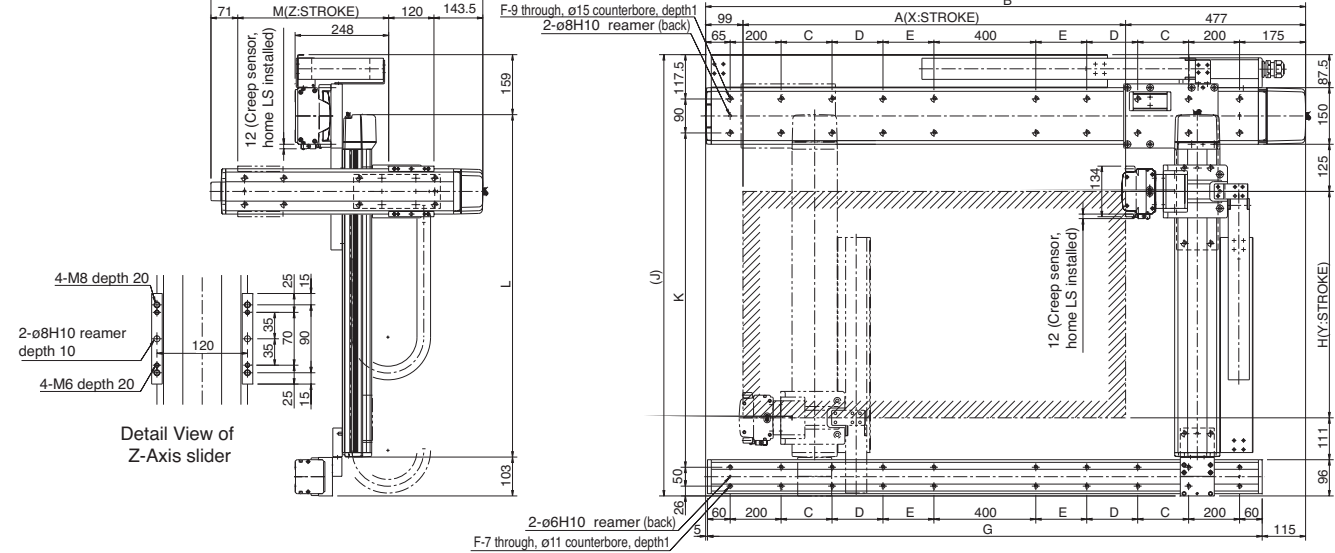

* The configuration position in the figure is home position.
To change the home position, indicate NM in the option.
Note that changing the home direction will require the actuator to be returned to IAI for adjustment.

X dimension

A	B	C	D	E	F	G
1014	1590	275	0	0	12	1470
1114	1690	325	0	0	12	1570
1214	1790	375	0	0	12	1670
1314	1890	425	0	0	12	1770
1414	1990	475	0	0	12	1870
1514	2090	525	0	0	12	1970
1614	2190	575	0	0	12	2070
1714	2290	200	425	0	16	2170
1814	2390	200	475	0	16	2270
1914	2490	200	525	0	16	2370
2014	2590	200	575	0	16	2470
2114	2690	200	200	425	20	2570
2214	2790	200	200	475	20	2670
2314	2890	200	200	525	20	2770
2414	2990	200	200	575	20	2870
2514	3090	200	200	625	20	2970

Y dimension

H	J	K	L
500	1069.5	786	807.5
600	1169.5	886	907.5
700	1269.5	986	1007.5

Z dimension

M	N(100W)	N(200W)
100	420.5	434.5
200	520.5	534.5
300	620.5	634.5
400	720.5	734.5
500	820.5	834.5
600	920.5	934.5

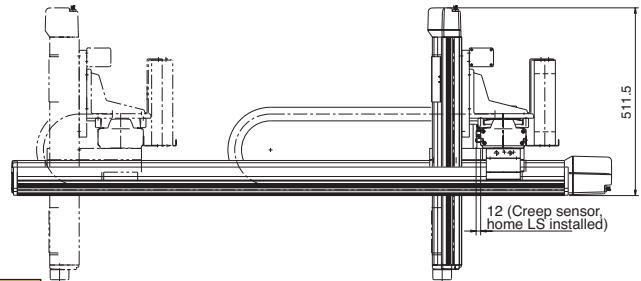

ICSA3-G2JHB1 □

Cartesian Robot: X-Y-Z 3-Axes Configuration
Z-Axis Base Mount Type

ICSPA3-G2JHB1 □

Cartesian Robot: X-Y-Z 3-Axes Configuration
Z-Axis Base Mount Type **High-Precision Specification**

Type XYG + Z-Axis Base Mount Type Stroke X-axis: 1000-2500mm Y-axis: 800-1200mm Z-axis: 100-600mm Load capacity 14kg ~ 3kg

Model specification items Series Type Encoder type X-axis stroke + options Y-axis stroke + options Z-axis stroke + options Applicable controller Cable length Cable management
(Example) ICSA3 (ICSPA3) - G2JHB1H - A - 100AQL - 80AQL - 30BL - T1 - 5L - CT-SC

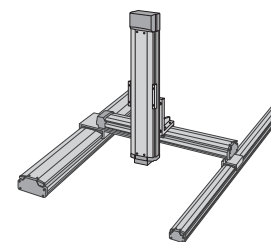

* Refer to page 51 for the details of model specification items.

Models/Specifications

* [] is for the high-precision specification.

Encoder Type	XY-axis configuration direction	Z-axis type (*1)	Model
Absolute	-	H	ICSA3 [ICSPA3] -G2JHB1H-A- [1]- [2]- [3]-B-T1- [4]- [5]
		M	ICSA3 [ICSPA3] -G2JHB1M-A- [1]- [2]- [3]-B-T1- [4]- [6]
		L	ICSA3 [ICSPA3] -G2JHB1L-A- [1]- [2]- [3]-B-T1- [4]- [6]
Incremental	-	H	ICSA3 [ICSPA3] -G2JHB1H-I- [1]- [2]- [3]-B-T1- [4]- [6]
		M	ICSA3 [ICSPA3] -G2JHB1M-I- [1]- [2]- [3]-B-T1- [4]- [6]
		L	ICSA3 [ICSPA3] -G2JHB1L-I- [1]- [2]- [3]-B-T1- [4]- [6]

*1: The load capacity and the maximum speed may vary depending on the type of Z-axis.
Note: T1 in the above models will be T2 when operated with XSEL-P/Q type.

Explanation of Model Code

Number	Contents	Specification
[1]	X-axis stroke (Note 1)	100 : 1000mm ~ 250 : 2500mm
[2]	Y-axis stroke (Note 1)	80 : 800mm ~ 120 : 1200mm
[3]	Z-axis stroke (Note 1)	10 : 100mm ~ 60 : 600mm
[4]	Cable length (Note 2)	3L : 3m 5L : 5m
[5]	Y-axis/ Z-axis cable management	CT-SC : Self-standing cable (*2) CT-CT : Cable track

* The above explains the Models/Specifications chart to the left.

*2 Only cable track can be specified for the Y-axis cable management with model # G2JHB1□.

Options

Please add the option codes at the end of each stroke of the axis.
When adding multiple options, put together in alphabetic order.

Name	Code	Page
AQ seal	AQ	P13
Brake	B	P13
Creep sensor	C	P13
Home limit switch	L	P14
Reversed-home specification	NM	P14
Guide with ball-retaining mechanism	RT	P14

Common Specifications

* [] is for the high-precision specification.

Drive system	Ball screw, rolled C10 [equivalent to rolled C5]
Positioning repeatability	±0.02mm [±0.01mm]
Backlash	0.05mm or less [0.02mm or less]
Guide	Integrated with base
Base	Material: Aluminum with white alumite treatment
X-axis motor output / lead	400W / 20mm
Y-axis motor output / lead	200W / 20mm
Z-axis motor output / lead	60W / 16mm (H), 8mm (M), 4mm (L)

Applicable Controller Specifications

Refer to page 65 for System Configuration.

Axis Configuration

* [] is for the high-precision specification.

Axis Type	Model	Page
X-axis	ISA[ISPA]-LXUWX-□-400-20-(Stroke)-T1	P30
Y-axis	ISA[ISPA]-MXMX-□-200-20-(Stroke)-T1	P20
Z-axis	ISA[ISPA]-SXM-□-60-16/8/4-(Stroke)-T1-B	P15

*In the above model name, □ indicates encoder type A (absolute) or I (incremental).



Caution

(Note 1) The stroke in the model is specified in cm (centimeters).

(Note 2) The cable length measures from the X-axis connector box to the controller. The standard lengths are 3m and 5m, but other lengths can also be specified in meters. The maximum length is 20m.

(Note 3) The rated acceleration is 0.3G. Increasing the acceleration will result in lower load capacity.

(Note 4) Please note that a longer stroke will result in a lower maximum speed.

* For other points to note, please refer to page 49.

ICSA3 [ICSPA3] -G2JHB1□

Load Capacity (kg) (Note3)

G2JHB1H

		Y-axis stroke				
		800	900	1000	1100	1200
Z-axis stroke	100	3.0				
	200	3.0				
	300	3.0				
	400	3.0				
	500	3.0				
	600	3.0				

G2JHB1M

		Y-axis stroke				
		800	900	1000	1100	1200
Z-axis stroke	100	6.0				
	200	6.0				
	300	6.0				
	400	6.0				
	500	6.0				
	600	6.0				

G2JHB1L

		Y-axis stroke				
		800	900	1000	1100	1200
Z-axis stroke	100	14.0				
	200	14.0				
	300	14.0				
	400	14.0				
	500	14.0				
	600	14.0				

Maximum Speed by Stroke (mm/sec) (Note4)

G2JHB1H

	Stroke														
	100~600	800~900	1000~1200	1300~1400	1500	1600	1700	1800	1900	2000	2100	2200	2300	2400	2500
X-axis	-	-	1000		950	830	740	650	590	540	490	440	410	370	300
Y-axis	-	1000			-	-	-	-	-	-	-	-	-	-	-
Z-axis	800	-	-	-	-	-	-	-	-	-	-	-	-	-	-

G2JHB1M

	Stroke														
	100~600	800~900	1000~1200	1300~1400	1500	1600	1700	1800	1900	2000	2100	2200	2300	2400	2500
X-axis	-	-	1000		950	830	740	650	590	540	490	440	410	370	300
Y-axis	-	1000			-	-	-	-	-	-	-	-	-	-	-
Z-axis	400	-	-	-	-	-	-	-	-	-	-	-	-	-	-

G2JHB1L

	Stroke														
	100~600	800~900	1000~1200	1300~1400	1500	1600	1700	1800	1900	2000	2100	2200	2300	2400	2500
X-axis	-	-	1000		950	830	740	650	590	540	490	440	410	370	300
Y-axis	-	1000			-	-	-	-	-	-	-	-	-	-	-
Z-axis	200	-	-	-	-	-	-	-	-	-	-	-	-	-	-

Dimensions

* The configuration position in the figure is home position. To change the home position, indicate NM in the option. Note that changing the home direction will require the actuator to be returned to IA1 for adjustment.

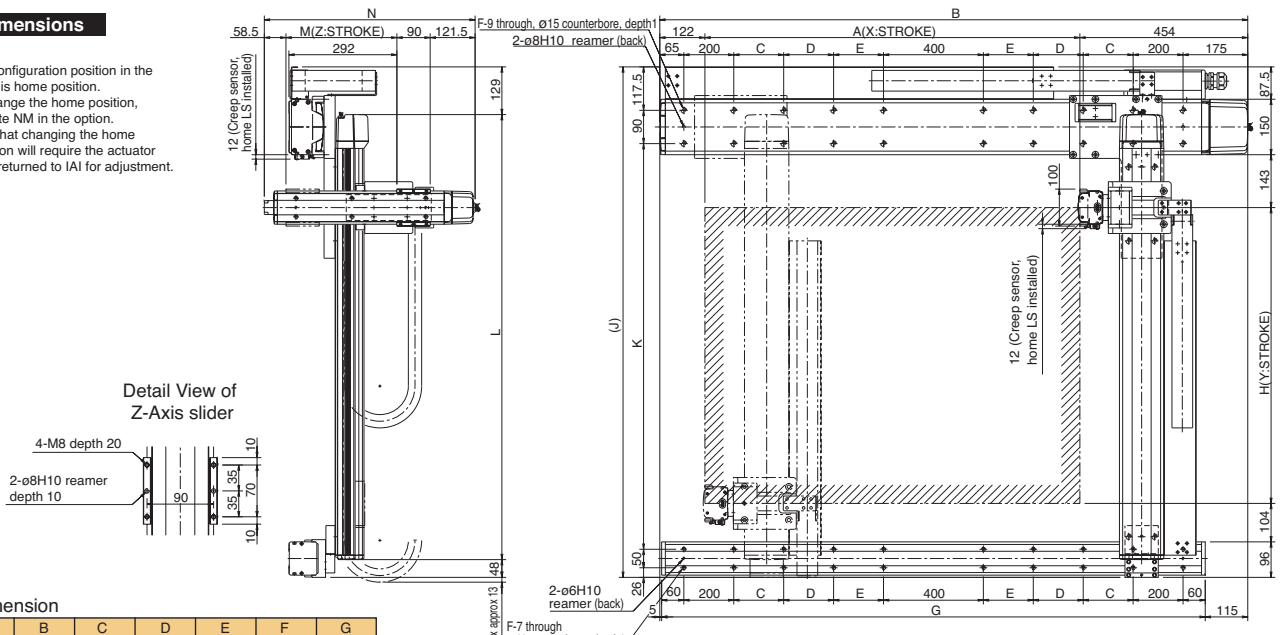

X dimension

A	B	C	D	E	F	G
1014	1590	275	0	0	12	1470
1114	1690	325	0	0	12	1570
1214	1790	375	0	0	12	1670
1314	1890	425	0	0	12	1770
1414	1990	475	0	0	12	1870
1514	2090	525	0	0	12	1970
1614	2190	575	0	0	12	2070
1714	2290	625	0	0	12	2170
1814	2390	675	0	0	12	2270
1914	2490	725	0	0	12	2370
2014	2590	775	0	0	12	2470
2114	2690	825	0	0	12	2570
2214	2790	875	0	0	12	2670
2314	2890	925	0	0	12	2770
2414	2990	975	0	0	12	2870
2514	3090	1025	0	0	12	2970

Y dimension

H	J	K	L
800	1380.5	1097	1203.5
900	1480.5	1197	1303.5
1000	1580.5	1297	1403.5
1100	1680.5	1397	1503.5
1200	1780.5	1497	1603.5

Z dimension

M	N
100	370
200	470
300	570
400	670
500	770
600	870

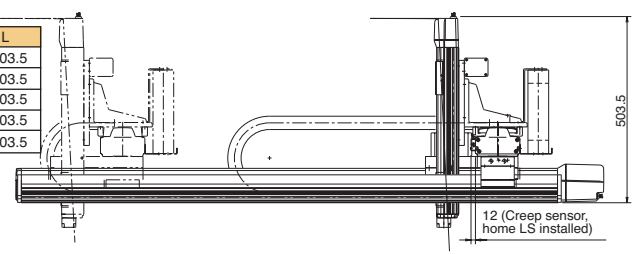

ICSA3-G2JHB2

Cartesian Robot: X-Y-Z 3-Axes Configuration
Z-Axis Base Mount Type

ICSPA3-G2JHB2

Cartesian Robot: X-Y-Z 3-Axes Configuration
Z-Axis Base Mount Type High-Precision Specification

Type XYG + Z-Axis Base Mount Type Stroke X-axis: 1000-2500mm Y-axis: 800-1200mm Z-axis: 100-600mm Load capacity 19kg ~ 3.5kg

Model specification items Series - Type - Encoder type - X-axis stroke + options - Y-axis stroke + options - Z-axis stroke + options - Applicable controller - Cable length - Cable management
(Example) ICSA3 (ICSPA3) - G2JHB2H - A - 100AQL - 80AQL - 30BL - T1 - 5L - CT-SC

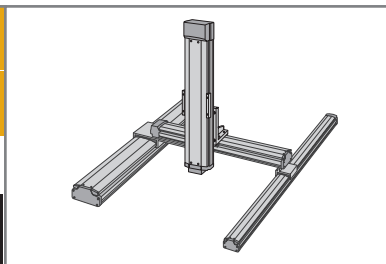

* Refer to page 51 for the details of model specification items.

Models/Specifications

Encoder Type	XY-axis configuration direction	Z-axis type (*1)	Model
Absolute	-	H	ICSA3 [ICSPA3] -G2JHB2H-A-①-②-③-B-T1-④-⑤
		M	ICSA3 [ICSPA3] -G2JHB2M-A-①-②-③-B-T1-④-⑤
		L	ICSA3 [ICSPA3] -G2JHB2L-A-①-②-③-B-T1-④-⑤
Incremental	-	H	ICSA3 [ICSPA3] -G2JHB2H-I-①-②-③-B-T1-④-⑤
		M	ICSA3 [ICSPA3] -G2JHB2M-I-①-②-③-B-T1-④-⑤
		L	ICSA3 [ICSPA3] -G2JHB2L-I-①-②-③-B-T1-④-⑤

*1: The load capacity and the maximum speed may vary depending on the type of Z-axis.
Note: T1 in the above models will be T2 when operated with XSEL-P/Q type.

Explanation of Model Code

Number	Contents	Specification
①	X-axis stroke (Note 1)	100 : 1000mm ~ 250 : 2500mm
②	Y-axis stroke (Note 1)	80 : 800mm ~ 120 : 1200mm
③	Z-axis stroke (Note 1)	10 : 100mm ~ 60 : 600mm
④	Cable length (Note 2)	3L : 3m 5L : 5m
⑤	Y-axis/ Z-axis cable management	CT-SC : Self-standing cable (*2) CT-CT : Cable track

* The above explains the Models/Specifications chart to the left.
*2 Only cable track can be specified for the Y-axis cable management with model # G2JHB2□.

Options

Please add the option codes at the end of each stroke of the axis.
When adding multiple options, put together in alphabetic order.

Name	Code	Page
AQ seal	AQ	P13
Brake	B	P13
Creep sensor	C	P13
Home limit switch	L	P14
Reversed-home specification	NM	P14
Guide with ball-retaining mechanism	RT	P14

Common Specifications

Drive system	Ball screw, rolled C10 [equivalent to rolled C5]
Positioning repeatability	±0.02mm [±0.01mm]
Backlash	0.05mm or less [0.02mm or less]
Guide	Integrated with base
Base	Material: Aluminum with white alumite treatment
X-axis motor output / lead	400W / 20mm
Y-axis motor output / lead	200W / 20mm
Z-axis motor output / lead	100W / 20mm (H), 10mm (M), 5mm (L)

Applicable Controller Specifications

Refer to page 65 for System Configuration.

Axis Configuration

Axis Type	Model	Page
X-axis	ISA[ISPA]-LXUWX-□-400-20-(Stroke)-T1	P30
Y-axis	ISA[ISPA]-MXMX-□-200-20-(Stroke)-T1	P20
Z-axis	ISA[ISPA]-MXM-□-100-20/10/5-(Stroke)-T1-B	P18

* In the above model name, □ indicates encoder type A (absolute) or I (incremental).

Caution

(Note 1) The stroke in the model is specified in cm (centimeters).
 (Note 2) The cable length measures from the X-axis connector box to the controller. The standard lengths are 3m and 5m, but other lengths can also be specified in meters. The maximum length is 20m.
 (Note 3) The rated acceleration is 0.3G. Increasing the acceleration will result in lower load capacity.
 (Note 4) Please note that a longer stroke will result in a lower maximum speed.

* For other points to note, please refer to page 49.

ICSA3 [ICSPA3] -G2JHB2□

Load Capacity (kg) (Note3)

G2JHB2H

		Y-axis stroke				
		800	900	1000	1100	1200
Z-axis stroke	100	3.5				
	200	3.5				
	300	3.5				
	400	3.5				
	500	3.5				
	600	3.5				

G2JHB2M

		Y-axis stroke				
		800	900	1000	1100	1200
Z-axis stroke	100	9.0				
	200	9.0				
	300	9.0				
	400	9.0				
	500	9.0				
	600	9.0				

G2JHB2L

		Y-axis stroke				
		800	900	1000	1100	1200
Z-axis stroke	100	19.0				
	200	19.0				
	300	19.0				
	400	19.0				
	500	18.8				
	600	17.8				

Maximum Speed by Stroke (mm/sec) (Note4)

G2JHB2H

	Stroke														
	100~600	800~900	1000~1200	1300~1400	1500	1600	1700	1800	1900	2000	2100	2200	2300	2400	2500
X-axis	-	-	1000		950	830	740	650	590	540	490	440	410	370	300
Y-axis	-	1000			-	-	-	-	-	-	-	-	-	-	-
Z-axis	1000	-	-	-	-	-	-	-	-	-	-	-	-	-	-

G2JHB2M

	Stroke														
	100~600	800~900	1000~1200	1300~1400	1500	1600	1700	1800	1900	2000	2100	2200	2300	2400	2500
X-axis	-	-	1000		950	830	740	650	590	540	490	440	410	370	300
Y-axis	-	1000			-	-	-	-	-	-	-	-	-	-	-
Z-axis	500	-	-	-	-	-	-	-	-	-	-	-	-	-	-

G2JHB2L

	Stroke														
	100~600	800~900	1000~1200	1300~1400	1500	1600	1700	1800	1900	2000	2100	2200	2300	2400	2500
X-axis	-	-	1000		950	830	740	650	590	540	490	440	410	370	300
Y-axis	-	1000			-	-	-	-	-	-	-	-	-	-	-
Z-axis	250	-	-	-	-	-	-	-	-	-	-	-	-	-	-

Dimensions

* The configuration position in the figure is home position. To change the home position, indicate NM in the option. Note that changing the home direction will require the actuator to be returned to IA1 for adjustment.

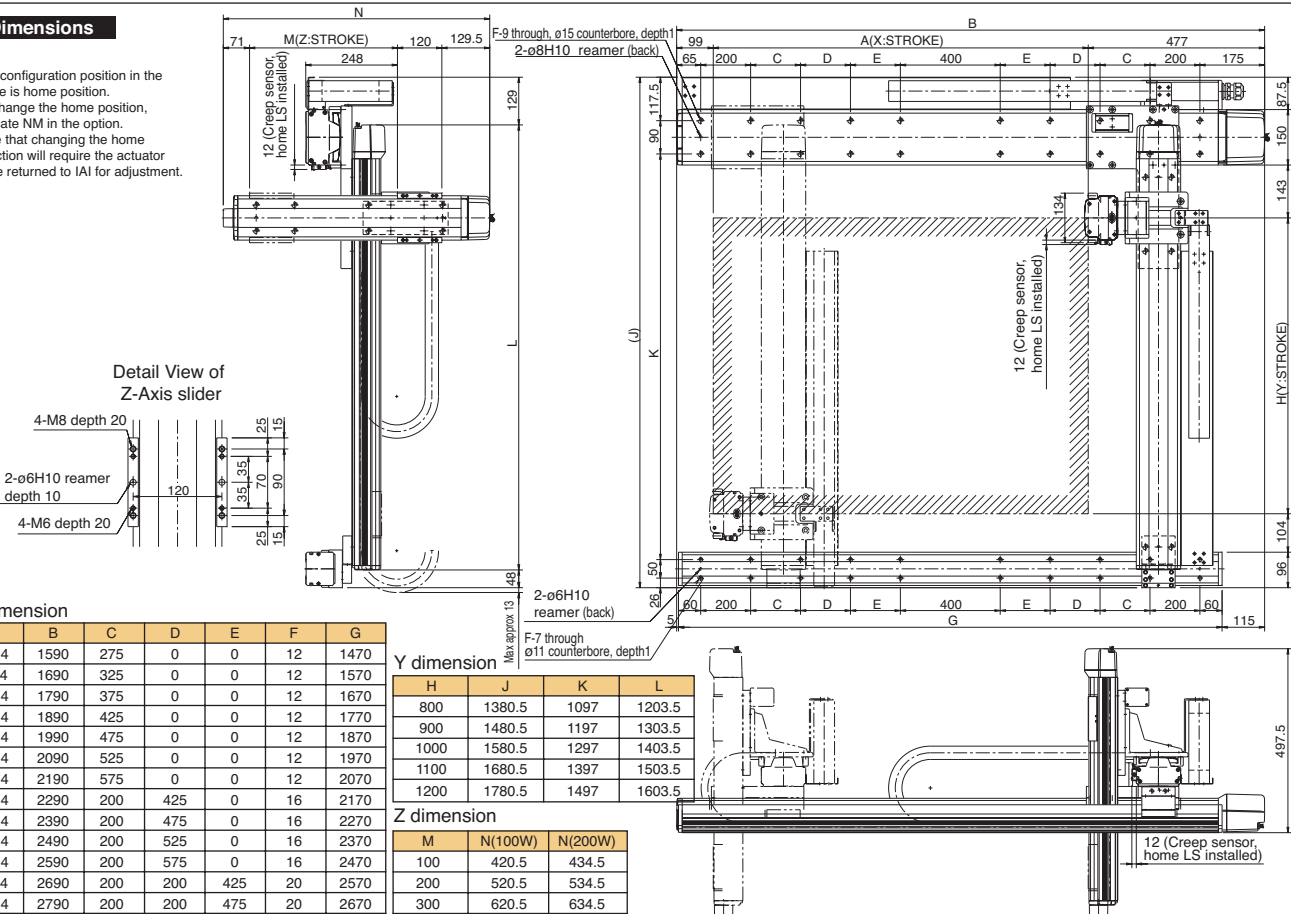

X dimension

A	B	C	D	E	F	G
1014	1590	275	0	0	12	1470
1114	1690	325	0	0	12	1570
1214	1790	375	0	0	12	1670
1314	1890	425	0	0	12	1770
1414	1990	475	0	0	12	1870
1514	2090	525	0	0	12	1970
1614	2190	575	0	0	12	2070
1714	2290	200	425	0	16	2170
1814	2390	200	475	0	16	2270
1914	2490	200	525	0	16	2370
2014	2590	200	575	0	16	2470
2114	2690	200	200	425	20	2570
2214	2790	200	200	475	20	2670
2314	2890	200	200	525	20	2770
2414	2990	200	200	575	20	2870
2514	3090	200	200	625	20	2970

Y dimension

H	J	K	L
800	1380.5	1097	1203.5
900	1480.5	1197	1303.5
1000	1580.5	1297	1403.5
1100	1680.5	1397	1503.5
1200	1780.5	1497	1603.5

Z dimension

M	N(100W)	N(200W)
100	420.5	434.5
200	520.5	534.5
300	620.5	634.5
400	720.5	734.5
500	820.5	834.5
600	920.5	934.5

ICSA3-G2JHB3

Cartesian Robot: X-Y-Z 3-Axes Configuration
Z-Axis Base Mount Type

ICSPA3-G2JHB3

Cartesian Robot: X-Y-Z 3-Axes Configuration
Z-Axis Base Mount Type **High-Precision Specification**

Type XYG + Z-Axis Base Mount Type **Stroke** X-axis: 1000-2500mm Y-axis: 800-1200mm Z-axis: 100-600mm **Load capacity** 19kg ~ 9kg

Model specification items
(Example) ICSA3 (ICSPA3) - G2JHB3H - A - 100AQL - 80AQL - 30BL - T1 - 5L - CT - SC

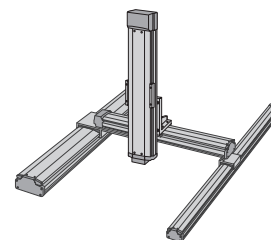

* Refer to page 51 for the details of model specification items.

Models/Specifications

Encoder Type	XY-axis configuration direction	Z-axis type (*1)	Model
Absolute	-	H	ICSA3 [ICSPA3] -G2JHB3H-A-①-②-③-B-T1-④-⑤
		M	ICSA3 [ICSPA3] -G2JHB3M-A-①-②-③-B-T1-④-⑤
		L	ICSA3 [ICSPA3] -G2JHB3L-A-①-②-③-B-T1-④-⑤
Incremental	-	H	ICSA3 [ICSPA3] -G2JHB3H-I-①-②-③-B-T1-④-⑤
		M	ICSA3 [ICSPA3] -G2JHB3M-I-①-②-③-B-T1-④-⑤
		L	ICSA3 [ICSPA3] -G2JHB3L-I-①-②-③-B-T1-④-⑤

*1: The load capacity and the maximum speed may vary depending on the type of Z-axis.
Note: T1 in the above models will be T2 when operated with XSEL-P/Q type.

Explanation of Model Code

Number	Contents	Specification
①	X-axis stroke (Note 1)	100 : 1000mm ~ 250 : 2500mm
②	Y-axis stroke (Note 1)	80 : 800mm ~ 120 : 1200mm
③	Z-axis stroke (Note 1)	10 : 100mm ~ 60 : 600mm
④	Cable length (Note 2)	3L : 3m 5L : 5m
⑤	Y-axis/ Z-axis cable management	CT-SC : Self-standing cable (*2) CT-CT : Cable track

* The above explains the Models/Specifications chart to the left.
*2 Only cable track can be specified for the Y-axis cable management with model # G2JHB3□.

Options

Please add the option codes at the end of each stroke of the axis.
When adding multiple options, put together in alphabetic order.

Name	Code	Page
AQ seal	AQ	P13
Brake	B	P13
Creep sensor	C	P13
Home limit switch	L	P14
Reversed-home specification	NM	P14
Guide with ball-retaining mechanism	RT	P14

Common Specifications

Drive system	Ball screw, rolled C10 [equivalent to rolled C5]
Positioning repeatability	±0.02mm [±0.01mm]
Backlash	0.05mm or less [0.02mm or less]
Guide	Integrated with base
Base	Material: Aluminum with white alumite treatment
X-axis motor output / lead	400W / 20mm
Y-axis motor output / lead	200W / 20mm
Z-axis motor output / lead	200W / 20mm (H), 10mm (M)

Applicable Controller Specifications

Refer to page 65 for System Configuration.

Axis Configuration

Axis Type	Model	Page
X-axis	ISA[ISPA]-LXUWX-□-400-20-(Stroke)-T1	P30
Y-axis	ISA[ISPA]-MXMX-□-200-20-(Stroke)-T1	P20
Z-axis	ISA[ISPA]-MXM-□-200-20/10-(Stroke)-T1-B	P19

*In the above model name, □ indicates encoder type A (absolute) or I (incremental).

Caution

(Note 1) The stroke in the model is specified in cm (centimeters).
 (Note 2) The cable length measures from the X-axis connector box to the controller. The standard lengths are 3m and 5m, but other lengths can also be specified in meters. The maximum length is 20m.
 (Note 3) The rated acceleration is 0.3G. Increasing the acceleration will result in lower load capacity.
 (Note 4) Please note that a longer stroke will result in a lower maximum speed.

* For other points to note, please refer to page 49.

ICSA3 [ICSPA3] -G2JHB3□

Load Capacity (kg) (Note3)

G2JHB3H

		Y-axis stroke				
		800	900	1000	1100	1200
Z-axis stroke	100	9.0				
	200	9.0				
	300	9.0				
	400	9.0				
	500	9.0				
	600	9.0				

G2JHB3M

		Y-axis stroke				
		800	900	1000	1100	1200
Z-axis stroke	100	19.0				
	200	19.0				
	300	19.0				
	400	18.7				
	500	17.6				
	600	16.6				

Maximum Speed by Stroke (mm/sec) (Note4)

G2JHB3H

	Stroke														
	100-600	800-900	1000-1200	1300-1400	1500	1600	1700	1800	1900	2000	2100	2200	2300	2400	2500
X-axis	-	-	1000		950	830	740	650	590	540	490	440	410	370	300
Y-axis	-	1000		-	-	-	-	-	-	-	-	-	-	-	-
Z-axis	1000	-	-	-	-	-	-	-	-	-	-	-	-	-	-

G2JHB3M

	Stroke														
	100-600	800-900	1000-1200	1300-1400	1500	1600	1700	1800	1900	2000	2100	2200	2300	2400	2500
X-axis	-	-	1000		950	830	740	650	590	540	490	440	410	370	300
Y-axis	-	1000		-	-	-	-	-	-	-	-	-	-	-	-
Z-axis	500	-	-	-	-	-	-	-	-	-	-	-	-	-	-

Dimensions

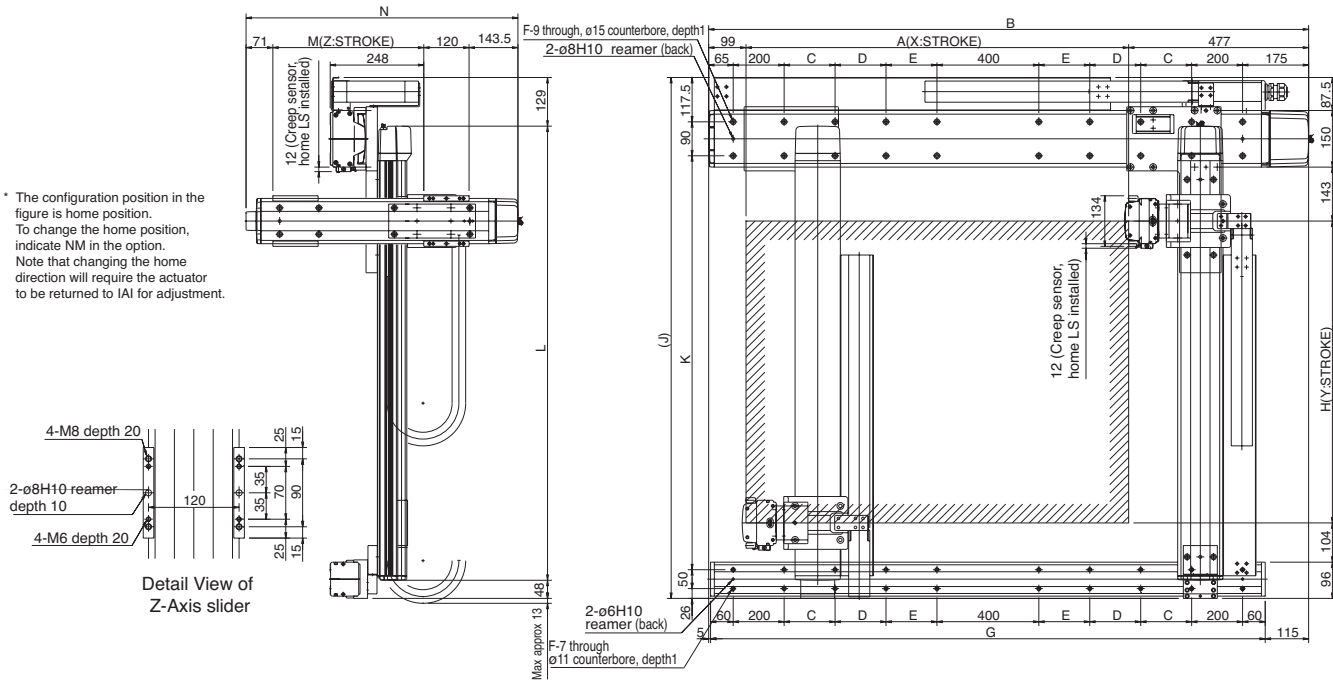

X dimension

A	B	C	D	E	F	G
1014	1590	275	0	0	12	1470
1114	1690	325	0	0	12	1570
1214	1790	375	0	0	12	1670
1314	1890	425	0	0	12	1770
1414	1990	475	0	0	12	1870
1514	2090	525	0	0	12	1970
1614	2190	575	0	0	12	2070
1714	2290	200	425	0	16	2170
1814	2390	200	475	0	16	2270
1914	2490	200	525	0	16	2370
2014	2590	200	575	0	16	2470
2114	2690	200	200	425	20	2570
2214	2790	200	200	475	20	2670
2314	2890	200	200	525	20	2770
2414	2990	200	200	575	20	2870
2514	3090	200	200	625	20	2970

Y dimension

H	J	K	L
800	1380.5	1097	1203.5
900	1480.5	1197	1303.5
1000	1580.5	1297	1403.5
1100	1680.5	1397	1503.5
1200	1780.5	1497	1603.5

Z dimension

M	N(100W)	N(200W)
100	420.5	434.5
200	520.5	534.5
300	620.5	634.5
400	720.5	734.5
500	820.5	834.5
600	920.5	934.5

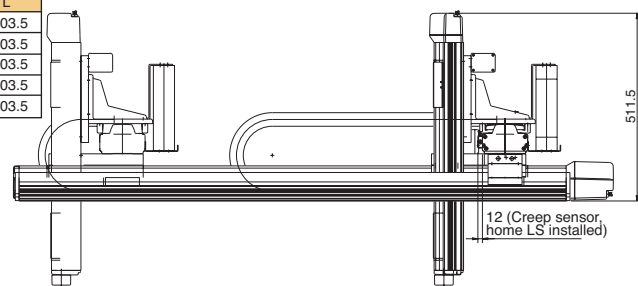

ICSA3-G1JHS1 □

Cartesian Robot: X-Y-Z 3-Axes Configuration
Z-Axis Slider Mount Type

ICSPA3-G1JHS1 □

Cartesian Robot: X-Y-Z 3-Axes Configuration
Z-Axis Slider Mount Type **High-Precision Specification**

Type / XYG + Z-Axis Slider Mount Type Stroke / X-axis: 1000-2500mm Y-axis: 500-700mm Z-axis: 100-400mm Load capacity / 11kg ~ 0.9kg

Model specification items Series - Type - Encoder type - X-axis stroke + options - Y-axis stroke + options - Z-axis stroke + options - Applicable controller - Cable length - Cable management
(Example) ICSA3 (ICSPA3) - G1JHS1H - A - 100AQL - 50AQL - 30BLNM - T1 - 5L - CT-SC

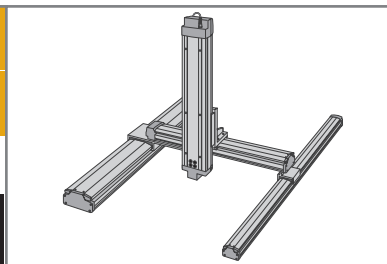

* Refer to page 51 for the details of model specification items.

Models/Specifications * [] is for the high-precision specification.

Encoder Type	XY-axis configuration direction	Z-axis type (*1)	Model
Absolute	-	M	ICSA3 [ICSPA3] -G1JHS1M-A- ① - ② - ③ -BNM-T1- ④ - ⑤
		L	ICSA3 [ICSPA3] -G1JHS1L-A- ① - ② - ③ -BNM-T1- ④ - ⑤
Incremental	-	M	ICSA3 [ICSPA3] -G1JHS1M-I- ① - ② - ③ -BNM-T1- ④ - ⑤
		L	ICSA3 [ICSPA3] -G1JHS1L-I- ① - ② - ③ -BNM-T1- ④ - ⑤

*1: The load capacity and the maximum speed may vary depending on the type of Z-axis.
Note: T1 in the above models will be T2 when operated with XSEL-P/Q type.

Explanation of Model Code

Number	Contents	Specification
①	X-axis stroke (Note 1)	100 : 1000mm ~ 250 : 2500mm
②	Y-axis stroke (Note 1)	50 : 500mm ~ 70 : 700mm
③	Z-axis stroke (Note 1)	10 : 100mm ~ 40 : 400mm
④	Cable length (Note 2)	3L : 3m 5L : 5m
⑤	Y-axis/ Z-axis cable management	CT-SC : Self-standing cable (*2)

* The above explains the Models/Specifications chart to the left.
*2 Only cable track can be specified for the Y-axis cable management with model # G1JHS1□ .

Options

Please add the option codes at the end of each stroke of the axis.
When adding multiple options, put together in alphabetic order.

Name	Code	Page
AQ seal	AQ	P13
Brake	B	P13
Creep sensor	C	P13
Home limit switch	L	P14
Reversed-home specification	NM	P14
Guide with ball-retaining mechanism	RT	P14

Common Specifications * [] is for the high-precision specification.

Drive system	Ball screw, rolled C10 [equivalent to rolled C5]
Positioning repeatability	±0.02mm [±0.01mm]
Backlash	0.05mm or less [0.02mm or less]
Guide	Integrated with base
Base	Material: Aluminum with white alumite treatment
X-axis motor output / lead	400W / 20mm
Y-axis motor output / lead	200W / 20mm
Z-axis motor output / lead	60W / 8mm (M), 4mm (L)

Applicable Controller Specifications

Refer to page 65 for System Configuration.

Axis Configuration * [] is for the high-precision specification.

Axis Type	Model	Page
X-axis	ISA[ISPA]-LXUWX-□-400-20-(Stroke)-T1	P30
Y-axis	ISA[ISPA]-MXM-□-200-20-(Stroke)-T1	P19
Z-axis	ISA[ISPA]-SZM-□-60-8/4-(Stroke)-T1-B-NM	P17

*In the above model name, □ indicates encoder type A (absolute) or I (incremental).

Caution

(Note 1) The stroke in the model is specified in cm (centimeters).
 (Note 2) The cable length measures from the X-axis connector box to the controller. The standard lengths are 3m and 5m, but other lengths can also be specified in meters. The maximum length is 20m.
 (Note 3) The rated acceleration is 0.3G. Increasing the acceleration will result in lower load capacity.
 (Note 4) Please note that a longer stroke will result in a lower maximum speed.

* For other points to note, please refer to page 49.

ICSA3 [ICSPA3] -G1JHS1□

Load Capacity (kg) (Note3)

G1JHS1M

		Y-axis stroke		
		500	600	700
Z-axis stroke	100	3.0		
	200	2.3		
	300	1.6		
	400	0.9		

G1JHS1L

		Y-axis stroke		
		500	600	700
Z-axis stroke	100	11.0		
	200	10.3		
	300	9.6		
	400	8.9		

Maximum Speed by Stroke (mm/sec) (Note4)

G1JHS1M

	Stroke															
	100-400	500	600	700	1000-1400	1500	1600	1700	1800	1900	2000	2100	2200	2300	2400	2500
X-axis	-	-	-	-	1000	950	830	740	650	590	540	490	440	410	370	300
Y-axis	-	1000			-	-	-	-	-	-	-	-	-	-	-	-
Z-axis	400	-	-	-	-	-	-	-	-	-	-	-	-	-	-	-

G1JHS1L

	Stroke															
	100-400	500	600	700	1000-1400	1500	1600	1700	1800	1900	2000	2100	2200	2300	2400	2500
X-axis	-	-	-	-	1000	950	830	740	650	590	540	490	440	410	370	300
Y-axis	-	1000			-	-	-	-	-	-	-	-	-	-	-	-
Z-axis	200	-	-	-	-	-	-	-	-	-	-	-	-	-	-	-

Dimensions

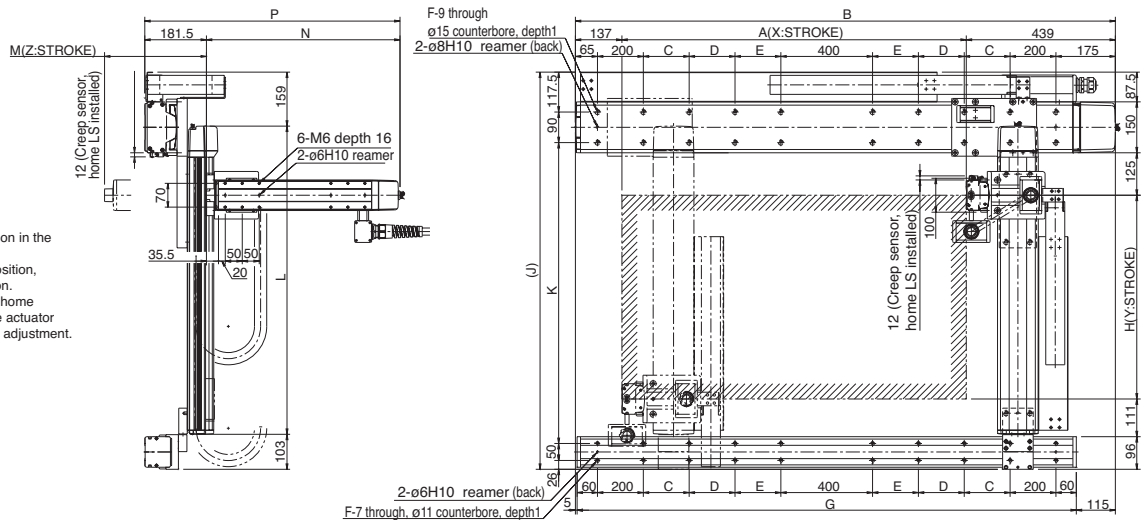

* The configuration position in the figure is home position. To change the home position, indicate NM in the option. Note that changing the home direction will require the actuator to be returned to IAI for adjustment.

X dimension

	A	B	C	D	E	F	G
1014	1590	275	0	0	12	1470	
1114	1690	325	0	0	12	1570	
1214	1790	375	0	0	12	1670	
1314	1890	425	0	0	12	1770	
1414	1990	475	0	0	12	1870	
1514	2090	525	0	0	12	1970	
1614	2190	575	0	0	12	2070	
1714	2290	200	425	0	16	2170	
1814	2390	200	475	0	16	2270	
1914	2490	200	525	0	16	2370	
2014	2590	200	575	0	16	2470	
2114	2690	200	200	425	20	2570	
2214	2790	200	200	475	20	2670	
2314	2890	200	200	525	20	2770	
2414	2990	200	200	575	20	2870	
2514	3090	200	200	625	20	2970	

Y dimension

H	J	K	L
500	1069.5	786	807.5
600	1169.5	886	907.5
700	1269.5	986	1007.5

Z dimension

M	N	P	Q
100	370	370	(800)
200	470	470	(900)
300	570	570	(1000)
400	670	670	(1100)

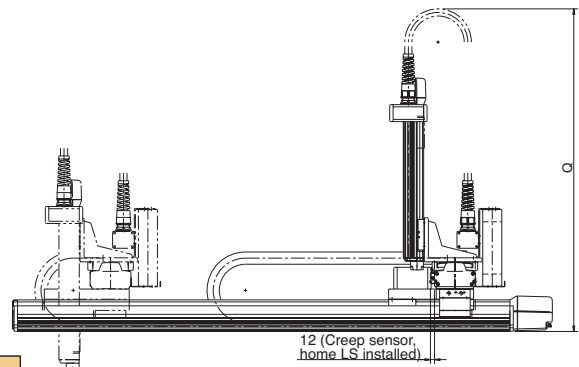

ICSA3-G1JHS2L

Cartesian Robot: X-Y-Z 3-Axes Configuration
Z-Axis Slider Mount Type

ICSPA3-G1JHS2L

Cartesian Robot: X-Y-Z 3-Axes Configuration
Z-Axis Slider Mount Type High-Precision Specification

Type / XYG + Z-Axis Slider Mount Type Stroke / X-axis: 1000-2500mm Y-axis: 500-700mm Z-axis: 100-400mm Load capacity / 13.1kg ~ 10.1kg

Model specification items Series - Type - Encoder type - X-axis stroke + options - Y-axis stroke + options - Z-axis stroke + options - Applicable controller - Cable length - Cable management
(Example) ICSA3 (ICSPA3) - G1JHS2L - A - 100AQL - 50AQL - 30BLNM - T1 - 5L - CT-SC

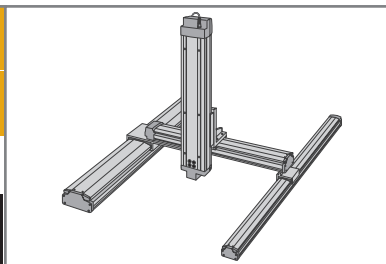

* Refer to page 51 for the details of model specification items.

Models/Specifications * [] is for the high-precision specification.

Encoder Type	XY-axis configuration direction	Z-axis type (*1)	Model
Absolute	-	L	ICSA3 [ICSPA3] -G1JHS2L-A- [1] - [2] - [3] -BNM-T1- [4] [5]
Incremental	-	L	ICSA3 [ICSPA3] -G1JHS2L-A- [1] - [2] - [3] -BNM-T1- [4] [5]

*1: The load capacity and the maximum speed may vary depending on the type of Z-axis.
Note: T1 in the above models will be T2 when operated with XSEL-P/Q type.

Explanation of Model Code

Number	Contents	Specification
[1]	X-axis stroke (Note 1)	100 : 1000mm ~ 250 : 2500mm
[2]	Y-axis stroke (Note 1)	50 : 500mm ~ 70 : 700mm
[3]	Z-axis stroke (Note 1)	10 : 100mm ~ 40 : 400mm
[4]	Cable length (Note 2)	3L : 3m 5L : 5m
[5]	Y-axis/ Z-axis cable management	CT-SC : Self-standing cable (*2)

* The above explains the Models/Specifications chart to the left.
*2 Only cable track can be specified for the Y-axis cable management with model # G1JHB2L.

Options

Please add the option codes at the end of each stroke of the axis.
When adding multiple options, put together in alphabetic order.

Name	Code	Page
AQ seal	AQ	P13
Brake	B	P13
Creep sensor	C	P13
Home limit switch	L	P14
Reversed-home specification	NM	P14
Guide with ball-retaining mechanism	RT	P14

Common Specifications * [] is for the high-precision specification.

Drive system	Ball screw, rolled C10 [equivalent to rolled C5]
Positioning repeatability	±0.02mm [±0.01mm]
Backlash	0.05mm or less [0.02mm or less]
Guide	Integrated with base
Base	Material: Aluminum with white alumite treatment
X-axis motor output / lead	400W / 20mm
Y-axis motor output / lead	200W / 20mm
Z-axis motor output / lead	100W / 5mm

Applicable Controller Specifications

Refer to page 65 for System Configuration.

Axis Configuration * [] is for the high-precision specification.

Axis Type	Model	Page
X-axis	ISA[ISPA]-LXUWX-□-400-20-(Stroke)-T1	P30
Y-axis	ISA[ISPA]-MXM-□-200-20-(Stroke)-T1	P19
Z-axis	ISA[ISPA]-MXM-□-100-5-(Stroke)-T1-B-NM	P18

* In the above model name, □ indicates encoder type A (absolute) or I (incremental).

Caution

(Note 1) The stroke in the model is specified in cm (centimeters).
(Note 2) The cable length measures from the X-axis connector box to the controller. The standard lengths are 3m and 5m, but other lengths can also be specified in meters. The maximum length is 20m.
(Note 3) The rated acceleration is 0.3G. Increasing the acceleration will result in lower load capacity.
(Note 4) Please note that a longer stroke will result in a lower maximum speed.

* For other points to note, please refer to page 49.

ICSA3 [ICSPA3] -G1JHS2L

Load Capacity (kg) (Note3)

G1JHS2L

		Y-axis stroke		
		500	600	700
Z-axis stroke	100	13.1		
	200	12.1		
	300	11.1		
	400	10.1		

Maximum Speed by Stroke (mm/sec) (Note4)

G1JHS2L

	Stroke													
	100~400	500~700	1000~1400	1500	1600	1700	1800	1900	2000	2100	2200	2300	2400	2500
X-axis	-	-	1000	950	830	740	650	590	540	490	440	410	370	300
Y-axis	-	1000	-	-	-	-	-	-	-	-	-	-	-	-
Z-axis	250	-	-	-	-	-	-	-	-	-	-	-	-	-

Dimensions

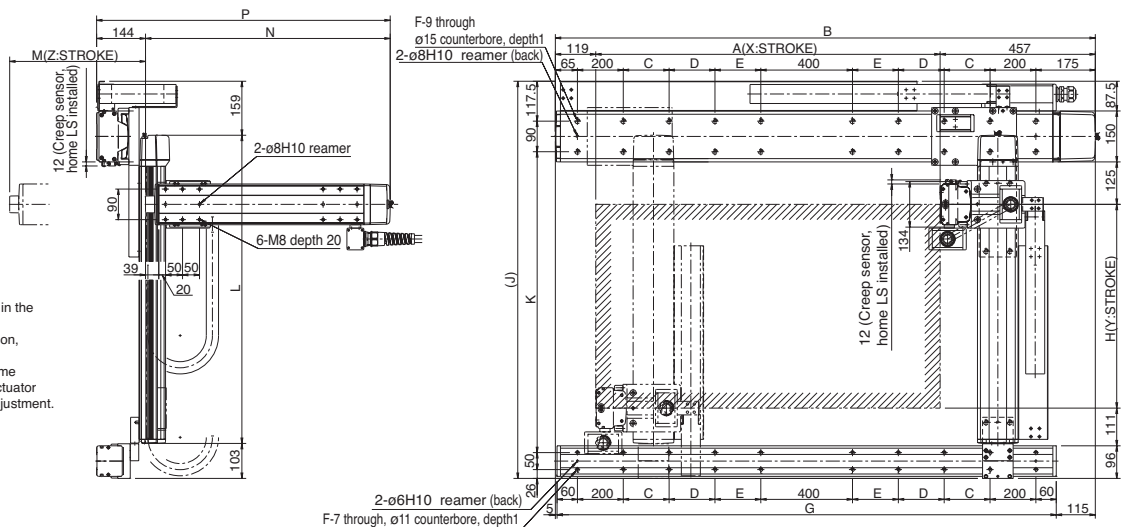

* The configuration position in the figure is home position. To change the home position, indicate NM in the option. Note that changing the home direction will require the actuator to be returned to IA1 for adjustment.

X dimension

	A	B	C	D	E	F	G
1014	1590	275	0	0	12	1470	
1114	1690	325	0	0	12	1570	
1214	1790	375	0	0	12	1670	
1314	1890	425	0	0	12	1770	
1414	1990	475	0	0	12	1870	
1514	2090	525	0	0	12	1970	
1614	2190	575	0	0	12	2070	
1714	2290	200	425	0	16	2170	
1814	2390	200	475	0	16	2270	
1914	2490	200	525	0	16	2370	
2014	2590	200	575	0	16	2470	
2114	2690	200	200	425	20	2570	
2214	2790	200	200	475	20	2670	
2314	2890	200	200	525	20	2770	
2414	2990	200	200	575	20	2870	
2514	3090	200	200	625	20	2970	

Y dimension

	H	J	K	L
500	1069.5	786	807.5	
600	1169.5	886	907.5	
700	1269.5	986	1007.5	

Z dimension

	M	N(100W)	N(200W)	P(100W)	P(200W)	Q
100	420.5	434.5	564.5	578.5	(800)	
200	520.5	534.5	664.5	678.5	(900)	
300	620.5	634.5	764.5	778.5	(1000)	
400	720.5	734.5	864.5	878.5	(1100)	
500	820.5	834.5	964.5	978.5	(1200)	

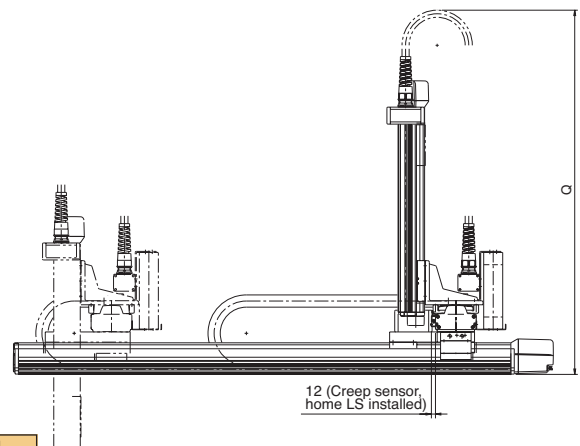

ICSA3-G1JHS3M

Cartesian Robot: X-Y-Z 3-Axes Configuration
Z-Axis Slider Mount Type

ICSPA3-G1JHS3M

Cartesian Robot: X-Y-Z 3-Axes Configuration
Z-Axis Slider Mount Type High-Precision Specification

Type / XYG + Z-Axis Slider Mount Type Stroke / X-axis: 1000-2500mm Y-axis: 500-700mm Z-axis: 100-500mm Load capacity / 11.9kg ~ 7.8kg

Model specification items
(Example) ICSA3 (ICSPA3) - G1JHS3M - A - 100AQL - 50AQL - 30BLNM - T1 - 5L - CT-SC

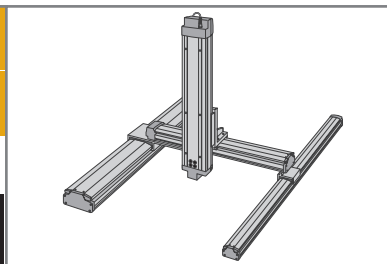

* Refer to page 51 for the details of model specification items.

Models/Specifications

Encoder Type	XY-axis configuration direction	Z-axis type (*1)	Model
Absolute	-	M	ICSA3 [ICSPA3] -G1JHS3M-A-①-②-③-BNM-T1-④-⑤
Incremental	-	M	ICSA3 [ICSPA3] -G1JHS3M-A-①-②-③-BNM-T1-④-⑤

*1: The load capacity and the maximum speed may vary depending on the type of Z-axis.
Note: T1 in the above models will be T2 when operated with XSEL-P/Q type.

Explanation of Model Code

Number	Contents	Specification
①	X-axis stroke (Note 1)	100 : 1000mm ~ 250 : 2500mm
②	Y-axis stroke (Note 1)	50 : 500mm ~ 70 : 700mm
③	Z-axis stroke (Note 1)	10 : 100mm ~ 50 : 500mm
④	Cable length (Note 2)	3L : 3m 5L : 5m
⑤	Y-axis/ Z-axis cable management	CT-SC : Self-standing cable (*2)

* The above explains the Models/Specifications chart to the left.
*2 Only cable track can be specified for the Y-axis cable management with model # G1JHS3M.

Options

Please add the option codes at the end of each stroke of the axis.
When adding multiple options, put together in alphabetic order.

Name	Code	Page
AQ seal	AQ	P13
Brake	B	P13
Creep sensor	C	P13
Home limit switch	L	P14
Reversed-home specification	NM	P14
Guide with ball-retaining mechanism	RT	P14

Common Specifications

Drive system	Ball screw, rolled C10 [equivalent to rolled C5]
Positioning repeatability	±0.02mm [±0.01mm]
Backlash	0.05mm or less [0.02mm or less]
Guide	Integrated with base
Base	Material: Aluminum with white alumite treatment
X-axis motor output / lead	400W / 20mm
Y-axis motor output / lead	200W / 20mm
Z-axis motor output / lead	200W / 10mm

Applicable Controller Specifications

Refer to page 65 for System Configuration.

Axis Configuration

Axis Type	Model	Page
X-axis	ISA[ISPA]-LXUWX-□-400-20-(Stroke)-T1	P30
Y-axis	ISA[ISPA]-MXM-□-200-20-(Stroke)-T1	P19
Z-axis	ISA[ISPA]-MZM-□-200-10-(Stroke)-T1-B-NM	P24

* In the above model name, □ indicates encoder type A (absolute) or I (incremental).

Caution

(Note 1) The stroke in the model is specified in cm (centimeters).
 (Note 2) The cable length measures from the X-axis connector box to the controller. The standard lengths are 3m and 5m, but other lengths can also be specified in meters. The maximum length is 20m.
 (Note 3) The rated acceleration is 0.3G. Increasing the acceleration will result in lower load capacity.
 (Note 4) Please note that a longer stroke will result in a lower maximum speed.

* For other points to note, please refer to page 49.

ICSA3 [ICSPA3] -G1JHS3M

Single-Axis Robots
Cartesian Robots

Load Capacity (kg) (Note3)

G1JHS3M

		Y-axis stroke		
		500	600	700
Z-axis stroke	100	11.9		
	200	10.9		
	300	9.9		
	400	8.9		
	500	7.8		

Maximum Speed by Stroke (mm/sec) (Note4)

G1JHS3M

	Stroke															
	100~400	500	600	700	1000~1400	1500	1600	1700	1800	1900	2000	2100	2200	2300	2400	2500
X-axis	-	-	-	-	1000	950	830	740	650	590	540	490	440	410	370	300
Y-axis	1000				-	-	-	-	-	-	-	-	-	-	-	-
Z-axis	500			-	-	-	-	-	-	-	-	-	-	-	-	-

Dimensions

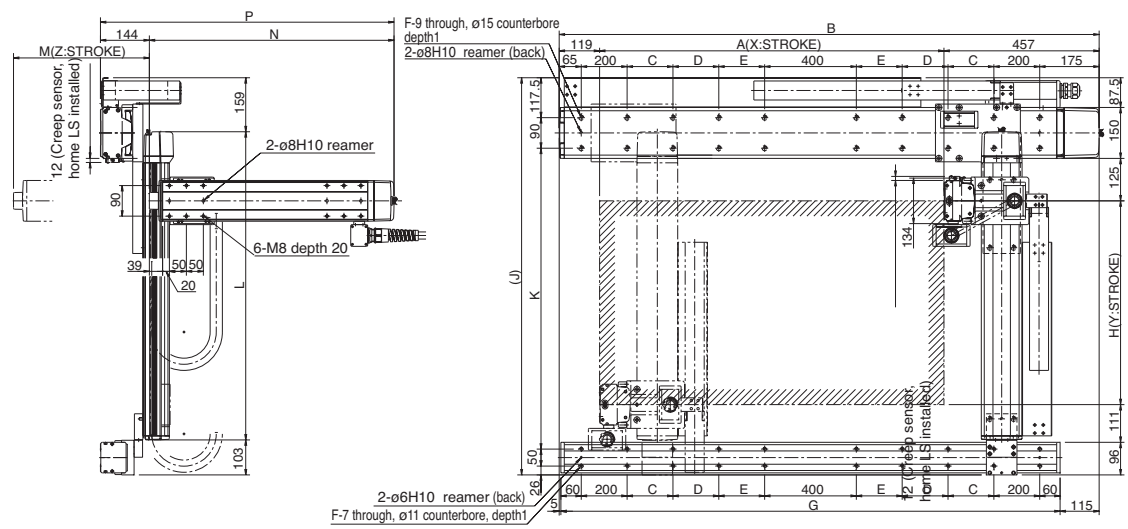

* The configuration position in the figure is home position.
To change the home position, indicate NM in the option.
Note that changing the home direction will require the actuator to be returned to IAI for adjustment.

X dimension

A	B	C	D	E	F	G
1014	1590	275	0	0	12	1470
1114	1690	325	0	0	12	1570
1214	1790	375	0	0	12	1670
1314	1890	425	0	0	12	1770
1414	1990	475	0	0	12	1870
1514	2090	525	0	0	12	1970
1614	2190	575	0	0	12	2070
1714	2290	200	425	0	16	2170
1814	2390	200	475	0	16	2270
1914	2490	200	525	0	16	2370
2014	2590	200	575	0	16	2470
2114	2690	200	200	425	20	2570
2214	2790	200	200	475	20	2670
2314	2890	200	200	525	20	2770
2414	2990	200	200	575	20	2870
2514	3090	200	200	625	20	2970

Y dimension

H	J	K	L
500	1069.5	786	807.5
600	1169.5	886	907.5
700	1269.5	986	1007.5

Z dimension

M	N(100W)	N(200W)	P(100W)	P(200W)	Q
100	420.5	434.5	564.5	578.5	(800)
200	520.5	534.5	664.5	678.5	(900)
300	620.5	634.5	764.5	778.5	(1000)
400	720.5	734.5	864.5	878.5	(1100)
500	820.5	834.5	964.5	978.5	(1200)

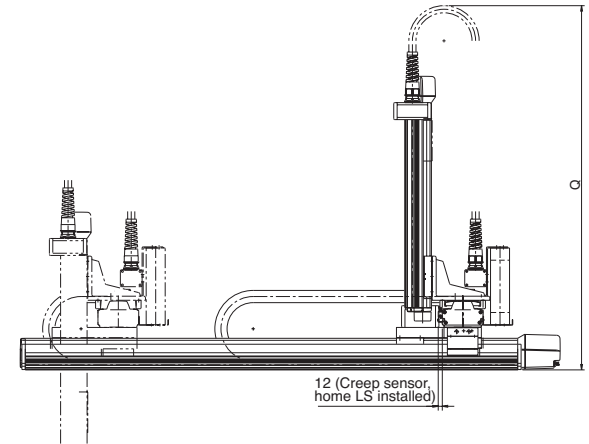

ICSA3-G2JHS1 □

Cartesian Robot: X-Y-Z 3-Axes Configuration
Z-Axis Slider Mount Type

ICSPA3-G2JHS1 □

Cartesian Robot: X-Y-Z 3-Axes Configuration
Z-Axis Slider Mount Type High-Precision Specification

Type / XYG + Z-Axis Slider Mount Type Stroke / X-axis: 1000-2500mm Y-axis: 800-1200mm Z-axis: 100-400mm Load capacity / 11kg ~ 0.9kg

Model specification items Series - Type - Encoder type - X-axis stroke + options - Y-axis stroke + options - Z-axis stroke + options - Applicable controller - Cable length - Cable management
(Example) ICSA3 (ICSPA3) - G2JHS1H - A - 100AQL - 100AQL - 30BLNM - T1 - 5L - CT-SC

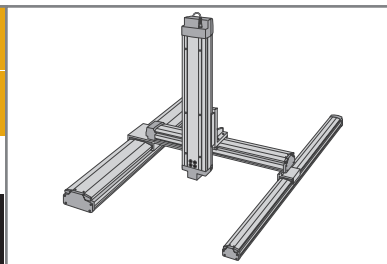

* Refer to page 51 for the details of model specification items.

Models/Specifications * [] is for the high-precision specification.

Encoder Type	XY-axis configuration direction	Z-axis type (*1)	Model
Absolute	-	M	ICSA3 [ICSPA3] -G2JHS1M-A- ① - ② - ③ -BNM-T1- ④ - ⑤
		L	ICSA3 [ICSPA3] -G2JHS1L-A- ① - ② - ③ -BNM-T1- ④ - ⑤
Incremental	-	M	ICSA3 [ICSPA3] -G2JHS1M-I- ① - ② - ③ -BNM-T1- ④ - ⑤
		L	ICSA3 [ICSPA3] -G2JHS1L-I- ① - ② - ③ -BNM-T1- ④ - ⑤

*1: The load capacity and the maximum speed may vary depending on the type of Z-axis.
Note: T1 in the above models will be T2 when operated with XSEL-P/Q type.

Explanation of Model Code

Number	Contents	Specification
①	X-axis stroke (Note 1)	100 : 1000mm ~ 250 : 2500mm
②	Y-axis stroke (Note 1)	80 : 800mm ~ 120 : 1200mm
③	Z-axis stroke (Note 1)	10 : 100mm ~ 40 : 400mm
④	Cable length (Note 2)	3L : 3m 5L : 5m
⑤	Y-axis/ Z-axis cable management	CT-SC : Self-standing cable (*2)

* The above explains the Models/Specifications chart to the left.
*2 Only cable track can be specified for the Y-axis cable management with model # G2JHS1□.

Options

Please add the option codes at the end of each stroke of the axis.
When adding multiple options, put together in alphabetic order.

Name	Code	Page
AQ seal	AQ	P13
Brake	B	P13
Creep sensor	C	P13
Home limit switch	L	P14
Reversed-home specification	NM	P14
Guide with ball-retaining mechanism	RT	P14

Common Specifications * [] is for the high-precision specification.

Drive system	Ball screw, rolled C10 [equivalent to rolled C5]
Positioning repeatability	±0.02mm [±0.01mm]
Backlash	0.05mm or less [0.02mm or less]
Guide	Integrated with base
Base	Material: Aluminum with white alumite treatment
X-axis motor output / lead	400W / 20mm
Y-axis motor output / lead	200W / 20mm
Z-axis motor output / lead	60W / 8mm (M), 4mm (L)

Applicable Controller Specifications

Refer to page 65 for System Configuration.

Axis Configuration * [] is for the high-precision specification.

Axis Type	Model	Page
X-axis	ISA[ISPA]-LXUWX-□-400-20-(Stroke)-T1	P30
Y-axis	ISA[ISPA]-MXMX-□-200-20-(Stroke)-T1	P20
Z-axis	ISA[ISPA]-SZM-□-60-8/4-(Stroke)-T1-B-NM	P17

* In the above model name, □ indicates encoder type A (absolute) or I (incremental).

Caution

(Note 1) The stroke in the model is specified in cm (centimeters).
 (Note 2) The cable length measures from the X-axis connector box to the controller. The standard lengths are 3m and 5m, but other lengths can also be specified in meters. The maximum length is 20m.
 (Note 3) The rated acceleration is 0.3G. Increasing the acceleration will result in lower load capacity.
 (Note 4) Please note that a longer stroke will result in a lower maximum speed.

* For other points to note, please refer to page 49.

ICSA3 [ICSPA3] -G2JHS1□

Load Capacity (kg) (Note3)

G2JHS1M

		Y-axis stroke				
		800	900	1000	1100	1200
Z-axis stroke	100	3.0				
	200	2.3				
	300	1.6				
	400	0.9				

G2JHS1L

		Y-axis stroke				
		800	900	1000	1100	1200
Z-axis stroke	100	11.0				
	200	10.3				
	300	9.6				
	400	8.9				

Maximum Speed by Stroke (mm/sec) (Note4)

G2JHS1M

	Stroke														
	100~400	800~900	1000~1200	1300~1400	1500	1600	1700	1800	1900	2000	2100	2200	2300	2400	2500
X-axis	-	-	1000		950	830	740	650	590	540	490	440	410	370	300
Y-axis	-	1000		-	-	-	-	-	-	-	-	-	-	-	-
Z-axis	400	-	-	-	-	-	-	-	-	-	-	-	-	-	-

G2JHS1L

	Stroke														
	100~400	800~900	1000~1200	1300~1400	1500	1600	1700	1800	1900	2000	2100	2200	2300	2400	2500
X-axis	-	-	1000		950	830	740	650	590	540	490	440	410	370	300
Y-axis	-	1000		-	-	-	-	-	-	-	-	-	-	-	-
Z-axis	200	-	-	-	-	-	-	-	-	-	-	-	-	-	-

Dimensions

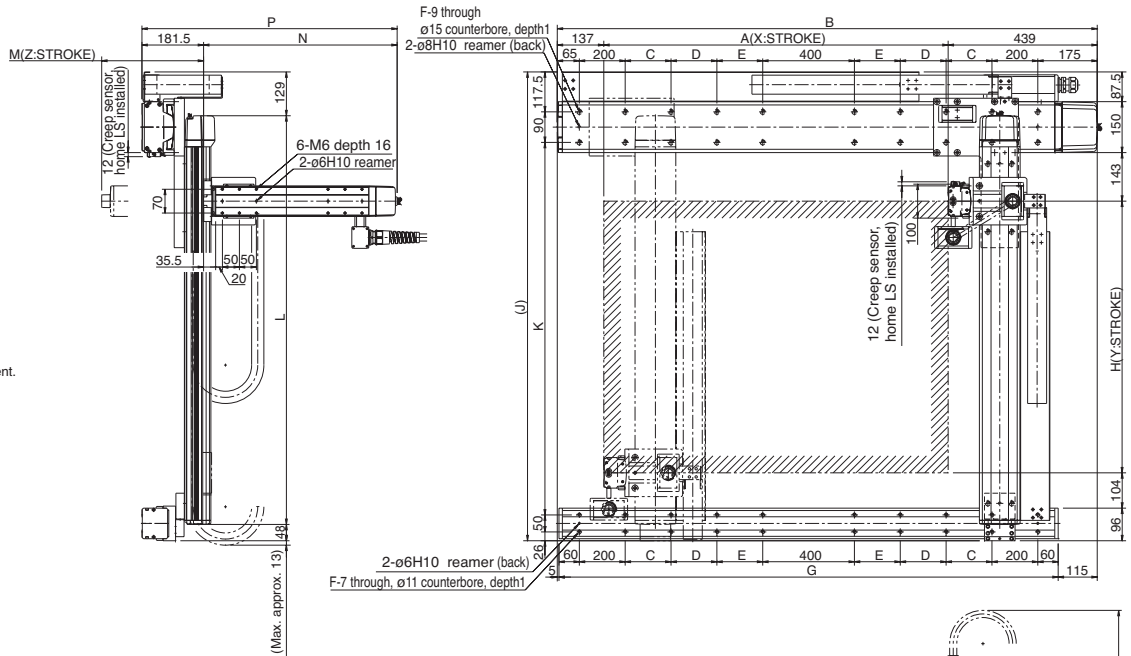

* The configuration position in the figure is home position. To change the home position, indicate NM in the option. Note that changing the home direction will require the actuator to be returned to IA for adjustment.

X dimension

A	B	C	D	E	F	G
1014	1590	275	0	0	12	1470
1114	1690	325	0	0	12	1570
1214	1790	375	0	0	12	1670
1314	1890	425	0	0	12	1770
1414	1990	475	0	0	12	1870
1514	2090	525	0	0	12	1970
1614	2190	575	0	0	12	2070
1714	2290	200	425	0	16	2170
1814	2390	200	475	0	16	2270
1914	2490	200	525	0	16	2370
2014	2590	200	575	0	16	2470
2114	2690	200	200	425	20	2570
2214	2790	200	200	475	20	2670
2314	2890	200	200	525	20	2770
2414	2990	200	200	575	20	2870
2514	3090	200	200	625	20	2970

Y dimension

H	J	K	L
800	1380.5	1097	1203.5
900	1480.5	1197	1303.5
1000	1580.5	1297	1403.5
1100	1680.5	1397	1503.5
1200	1780.5	1497	1603.5

Z dimension

M	N	P	Q
100	370	370	(800)
200	470	470	(900)
300	570	570	(1000)
400	670	670	(1100)

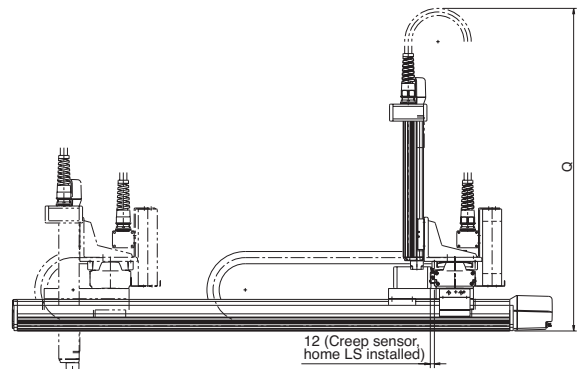

ICSA3-G2JHS2L

Cartesian Robot: X-Y-Z 3-Axes Configuration
Z-Axis Slider Mount Type

ICSPA3-G2JHS2L

Cartesian Robot: X-Y-Z 3-Axes Configuration
Z-Axis Slider Mount Type **High-Precision Specification**

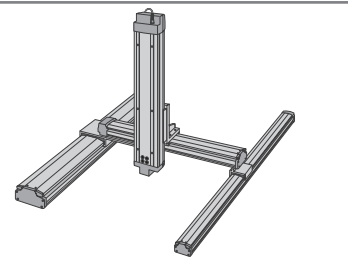

Type / XYG + Z-Axis Slider Mount Type | **Stroke** / X-axis: 1000-2500mm Y-axis: 800-1200mm Z-axis: 100-400mm | **Load capacity** / 13.1kg ~ 10.1kg

Model specification items: Series - Type - Encoder type - X-axis stroke + options - Y-axis stroke + options - Z-axis stroke + options - Applicable controller - Cable length - Cable management
(Example) ICSA3 (ICSPA3) - G2JHS2L - A - 100AQL - 100AQL - 30BLNM - T1 - 5L - CT-SC

* Refer to page 51 for the details of model specification items.

Models/Specifications

* [] is for the high-precision specification.

Encoder Type	XY-axis configuration direction	Z-axis type (*1)	Model
Absolute	-	L	ICSA3 [ICSPA3] -G2JHS2L-A- [1] - [2] - [3] -BNM-T1- [4] [5]
Incremental	-	L	ICSA3 [ICSPA3] -G2JHS2L-A- [1] - [2] - [3] -BNM-T1- [4] [5]

*1: The load capacity and the maximum speed may vary depending on the type of Z-axis.
Note: T1 in the above models will be T2 when operated with XSEL-P/Q type.

Explanation of Model Code

Number	Contents	Specification
[1]	X-axis stroke (Note 1)	100 : 1000mm ~ 250 : 2500mm
[2]	Y-axis stroke (Note 1)	80 : 800mm ~ 120 : 1200mm
[3]	Z-axis stroke (Note 1)	10 : 100mm ~ 40 : 400mm
[4]	Cable length (Note 2)	3L : 3m 5L : 5m
[5]	Y-axis/ Z-axis cable management	CT-SC : Self-standing cable (*2)

* The above explains the Models/Specifications chart to the left.
*2 Only cable track can be specified for the Y-axis cable management with model # G2JHS2L.

Options

Please add the option codes at the end of each stroke of the axis.
When adding multiple options, put together in alphabetic order.

Name	Code	Page
AQ seal	AQ	P13
Brake	B	P13
Creep sensor	C	P13
Home limit switch	L	P14
Reversed-home specification	NM	P14
Guide with ball-retaining mechanism	RT	P14

Common Specifications

* [] is for the high-precision specification.

Drive system	Ball screw, rolled C10 [equivalent to rolled C5]
Positioning repeatability	±0.02mm [±0.01mm]
Backlash	0.05mm or less [0.02mm or less]
Guide	Integrated with base
Base	Material: Aluminum with white alumite treatment
X-axis motor output / lead	400W / 20mm
Y-axis motor output / lead	200W / 20mm
Z-axis motor output / lead	100W / 5mm (L)

Applicable Controller Specifications

Refer to page 65 for System Configuration.

Axis Configuration

* [] is for the high-precision specification.

Axis Type	Model	Page
X-axis	ISA[ISPA]-LXUWX-□-400-20-(Stroke)-T1	P30
Y-axis	ISA[ISPA]-MXMX-□-200-20-(Stroke)-T1	P20
Z-axis	ISA[ISPA]-MZM-□-100-5-(Stroke)-T1-B-NM	P23

* In the above model name, □ indicates encoder type A (absolute) or I (incremental).

Caution

(Note 1) The stroke in the model is specified in cm (centimeters).
 (Note 2) The cable length measures from the X-axis connector box to the controller. The standard lengths are 3m and 5m, but other lengths can also be specified in meters. The maximum length is 20m.
 (Note 3) The rated acceleration is 0.3G. Increasing the acceleration will result in lower load capacity.
 (Note 4) Please note that a longer stroke will result in a lower maximum speed.

* For other points to note, please refer to page 49.

ICSA3 [ICSPA3] -G2JHS2L

Load Capacity by (kg) (Note3)

G2JHS2L

		Y-axis stroke				
		800	900	1000	1100	1200
Z-axis stroke	100	13.1				
	200	12.1				
	300	11.1				
	400	10.1				

Maximum Speed by Stroke (mm/sec) (Note4)

G2JHS2L

	Stroke														
	100~400	800~900	1000~1200	1300~1400	1500	1600	1700	1800	1900	2000	2100	2200	2300	2400	2500
X-axis	-	-	1000		950	830	740	650	590	540	490	440	410	370	300
Y-axis	-	1000		-	-	-	-	-	-	-	-	-	-	-	-
Z-axis	250	-	-	-	-	-	-	-	-	-	-	-	-	-	-

Dimensions

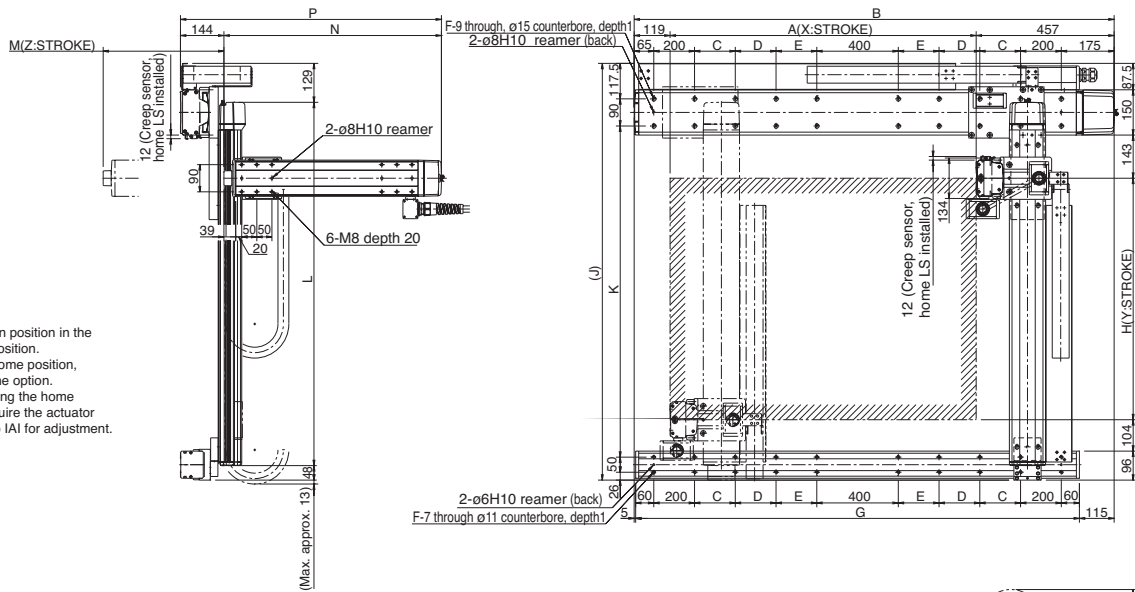

* The configuration position in the figure is home position. To change the home position, indicate NM in the option. Note that changing the home direction will require the actuator to be returned to IA1 for adjustment.

X dimension

A	B	C	D	E	F	G
1014	1590	275	0	0	12	1470
1114	1690	325	0	0	12	1570
1214	1790	375	0	0	12	1670
1314	1890	425	0	0	12	1770
1414	1990	475	0	0	12	1870
1514	2090	525	0	0	12	1970
1614	2190	575	0	0	12	2070
1714	2290	200	425	0	16	2170
1814	2390	200	475	0	16	2270
1914	2490	200	525	0	16	2370
2014	2590	200	575	0	16	2470
2114	2690	200	200	425	20	2570
2214	2790	200	200	475	20	2670
2314	2890	200	200	525	20	2770
2414	2990	200	200	575	20	2870
2514	3090	200	200	625	20	2970

Y dimension

H	J	K	L
800	1380.5	1097	1203.5
900	1480.5	1197	1303.5
1000	1580.5	1297	1403.5
1100	1680.5	1397	1503.5
1200	1780.5	1497	1603.5

Z dimension

M	N(100W)	N(200W)	P(100W)	P(200W)	Q
100	420.5	434.5	564.5	578.5	(800)
200	520.5	534.5	664.5	678.5	(900)
300	620.5	634.5	764.5	778.5	(1000)
400	720.5	734.5	864.5	878.5	(1100)
500	820.5	834.5	964.5	978.5	(1200)

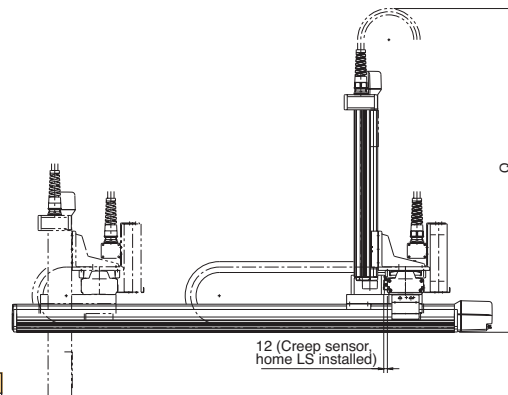

ICSA3-G2JHS3M

Cartesian Robot: X-Y-Z 3-Axes Configuration
Z-Axis Slider Mount Type

ICSPA3-G2JHS3M

Cartesian Robot: X-Y-Z 3-Axes Configuration
Z-Axis Slider Mount Type **High-Precision Specification**

Type / XYG + Z-Axis Slider Mount Type | **Stroke** / X-axis: 1000-2500mm Y-axis: 800-1200mm Z-axis: 100-500mm | **Load capacity** / 11.9kg ~ 7.8kg

Model specification items
(Example) ICSA3 (ICSPA3) - G2JHS3M - A - 100AQL - 100AQL - 30BLNM - T1 - 5L - CT-SC

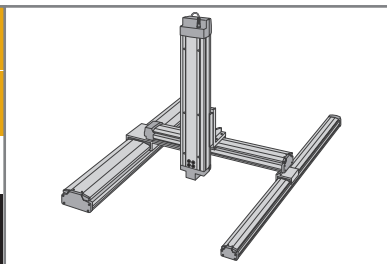

* Refer to page 51 for the details of model specification items.

Models/Specifications

* [] is for the high-precision specification.

Encoder Type	XY-axis configuration direction	Z-axis type (*1)	Model
Absolute	-	M	ICSA3 [ICSPA3] -G2JHS3M-A-①-②-③-BNM-T1-④-⑤
Incremental	-	M	ICSA3 [ICSPA3] -G2JHS3M-A-①-②-③-BNM-T1-④-⑤

*1: The load capacity and the maximum speed may vary depending on the type of Z-axis.
Note: T1 in the above models will be T2 when operated with XSEL-P/Q type.

Explanation of Model Code

Number	Contents	Specification
①	X-axis stroke (Note 1)	100 : 1000mm ~ 250 : 2500mm
②	Y-axis stroke (Note 1)	80 : 800mm ~ 120 : 1200mm
③	Z-axis stroke (Note 1)	10 : 100mm ~ 40 : 400mm
④	Cable length (Note 2)	3L : 3m 5L : 5m
⑤	Y-axis/ Z-axis cable management	CT-SC : Self-standing cable (*2)

* The above explains the Models/Specifications chart to the left.
*2 Only cable track can be specified for the Y-axis cable management with model # G2JHS3M.

Options

Please add the option codes at the end of each stroke of the axis.
When adding multiple options, put together in alphabetic order.

Name	Code	Page
AQ seal	AQ	P13
Brake	B	P13
Creep sensor	C	P13
Home limit switch	L	P14
Reversed-home specification	NM	P14
Guide with ball-retaining mechanism	RT	P14

Common Specifications

* [] is for the high-precision specification.

Drive system	Ball screw, rolled C10 [equivalent to rolled C5]
Positioning repeatability	±0.02mm [±0.01mm]
Backlash	0.05mm or less [0.02mm or less]
Guide	Integrated with base
Base	Material: Aluminum with white alumite treatment
X-axis motor output / lead	400W / 20mm
Y-axis motor output / lead	200W / 20mm
Z-axis motor output / lead	200W / 10mm

Applicable Controller Specifications

Refer to page 65 for System Configuration.

Axis Configuration

* [] is for the high-precision specification.

Axis Type	Model	Page
X-axis	ISA[ISPA]-LXUWX-□-400-20-(Stroke)-T1	P30
Y-axis	ISA[ISPA]-MXMX-□-200-20-(Stroke)-T1	P20
Z-axis	ISA[ISPA]-MZM-□-200-10-(Stroke)-T1-B-NM	P24

*In the above model name, □ indicates encoder type A (absolute) or I (incremental).

Caution

(Note 1) The stroke in the model is specified in cm (centimeters).
 (Note 2) The cable length measures from the X-axis connector box to the controller. The standard lengths are 3m and 5m, but other lengths can also be specified in meters. The maximum length is 20m.
 (Note 3) The rated acceleration is 0.3G. Increasing the acceleration will result in lower load capacity.
 (Note 4) Please note that a longer stroke will result in a lower maximum speed.

* For other points to note, please refer to page 49.

ICSA3 [ICSPA3] -G2JHS3M

Load Capacity (kg) (Note3)

G2JHS3M

		Y-axis stroke				
		800	900	1000	1100	1200
Z-axis stroke	100	11.9				
	200	10.9				
	300	9.9				
	400	8.9				
	500	7.8				

Maximum Speed by Stroke (mm/sec) (Note4)

G2JHS3M

	Stroke														
	100~400	800~900	1000~1200	1300~1400	1500	1600	1700	1800	1900	2000	2100	2200	2300	2400	2500
X-axis	-	-	1000		950	830	740	650	590	540	490	440	410	370	300
Y-axis	-	1000		-	-	-	-	-	-	-	-	-	-	-	-
Z-axis	500	-	-	-	-	-	-	-	-	-	-	-	-	-	-

Dimensions

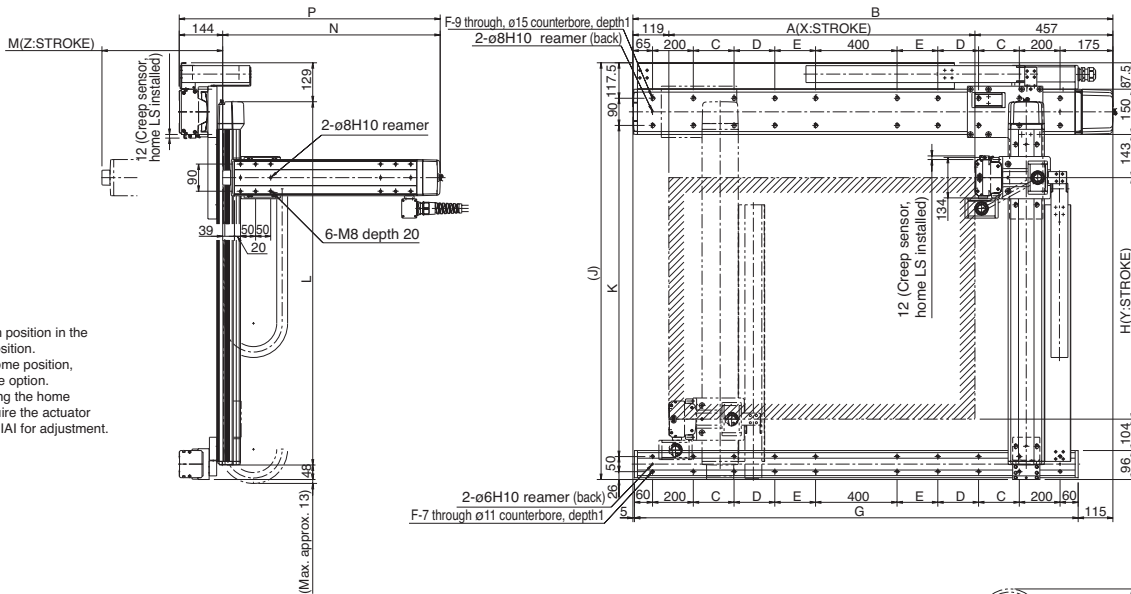

* The configuration position in the figure is home position. To change the home position, indicate NM in the option. Note that changing the home direction will require the actuator to be returned to IA1 for adjustment.

X dimension

A	B	C	D	E	F	G
1014	1590	275	0	0	12	1470
1114	1690	325	0	0	12	1570
1214	1790	375	0	0	12	1670
1314	1890	425	0	0	12	1770
1414	1990	475	0	0	12	1870
1514	2090	525	0	0	12	1970
1614	2190	575	0	0	12	2070
1714	2290	200	425	0	16	2170
1814	2390	200	475	0	16	2270
1914	2490	200	525	0	16	2370
2014	2590	200	575	0	16	2470
2114	2690	200	200	425	20	2570
2214	2790	200	200	475	20	2670
2314	2890	200	200	525	20	2770
2414	2990	200	200	575	20	2870
2514	3090	200	200	625	20	2970

Y dimension

H	J	K	L
800	1380.5	1097	1203.5
900	1480.5	1197	1303.5
1000	1580.5	1297	1403.5
1100	1680.5	1397	1503.5
1200	1780.5	1497	1603.5

Z dimension

M	N(100W)	N(200W)	P(100W)	P(200W)	Q
100	420.5	434.5	564.5	578.5	(800)
200	520.5	534.5	664.5	678.5	(900)
300	620.5	634.5	764.5	778.5	(1000)
400	720.5	734.5	864.5	878.5	(1100)
500	820.5	834.5	964.5	978.5	(1200)

