

IAI

Quality and Innovation

ROBO Cylinder[®] with Built-in Controller

ERC3 series



**The stainless sheet
type and gateway
unit have been added
to the series!**



www.intelligentactuator.com

Features of ERC3

1. Space-saving and wire-saving, because no space is needed to install a controller

Conventional system

ERC3 series

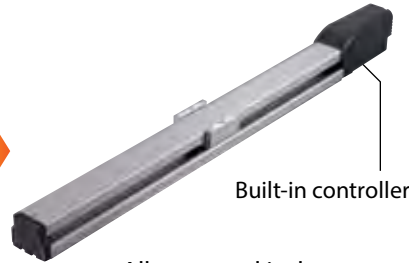

Built-in controller

All you need is the actuator, because a controller is built in.

The space-saving design lets you effectively utilize your facility.

Controllers for actuators

No need for controller space

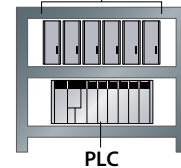

PLC

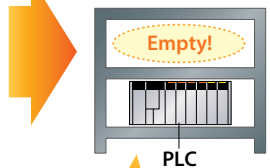

Empty!

PLC

No space is needed to install controllers, so the control panel can be made smaller.

2. Since a controller is built into the actuator, teaching can be performed near the actuator.

Conventional system

ERC3 series

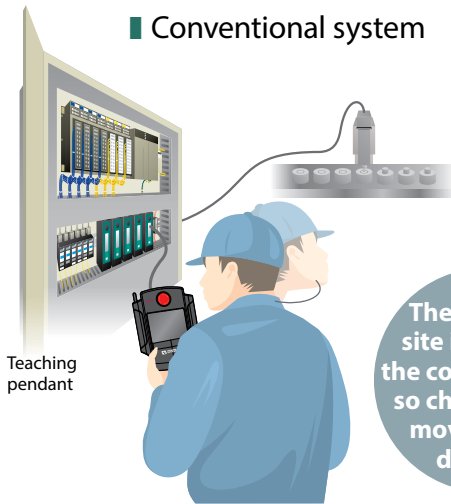

Teaching pendant

The teaching site is far from the control panel, so checking the movement is difficult.

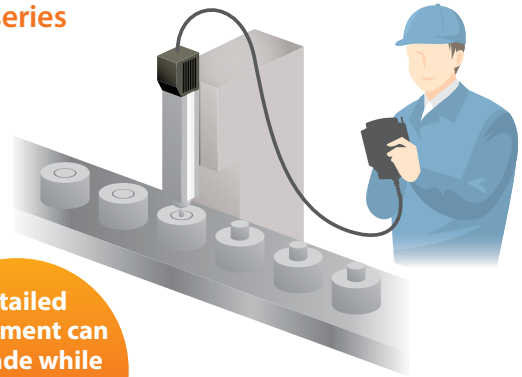

Detailed adjustment can be made while checking the movement close by.

3. The high-output driver boosts the payload to approx. 1.5 times and maximum speed also to 1.5 times compared to a conventional model

4. The maximum standard stroke has been extended.

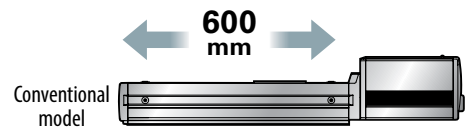
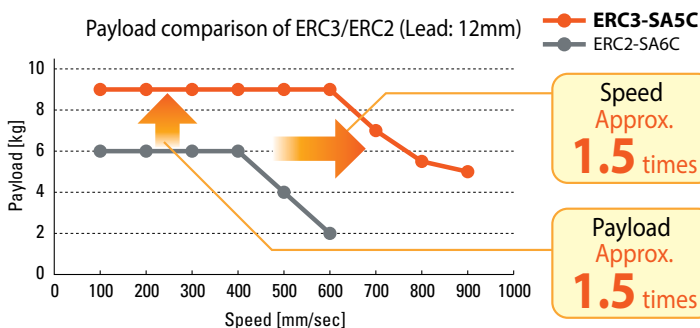

600 mm

Conventional model

30% longer

800 mm

ERC3 series





The ERC3 is a ROBO Cylinder comprising a built-in controller and actuator. Two types of controllers are available for the ERC3: "CON" type and "MEC" type. Specify an appropriate type in your order.

CON type	<p>Use this type if you use motorized cylinder applications frequently.</p> <ul style="list-style-type: none"> • 16 positioning points under the standard specification, extendable up to 512 points when the PIO converter (optional) is used • Connectable to major field networks using the gateway unit (optional)
MEC type	<p>Use this type if the actuator only needs to move through 2 or 3 points, just like an air cylinder.</p> <ul style="list-style-type: none"> • Operable only with the Quick Teach (optional) without a power-supply unit or PLC

Refer to P. 5 for details. →

Quick Teach RCM-PST

Connect the Quick Teach, and you can perform teaching or trial operation with the ERC3 without supplying power.



Quick Teach

Refer to P. 7 to 9, 51 and 52.

PIO converter RCB-CV

Connect the PIO converter to increase the number of positioning points to 512 or use the ERC3 as a simple absolute unit.



PIO converter

Refer to P. 45 to 47.

Gateway unit RCM-EGW

This unit lets you connect the ERC3 to a CC-Link, DeviceNet or other field network.







Gateway unit

Refer to P. 48 to 50.

Actuator Product Lineup

The product lineup of the controller-integrated actuator series ERC3 is shown below.

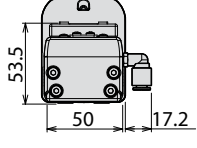
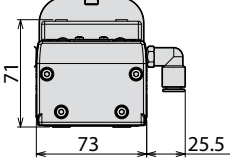
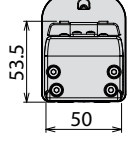
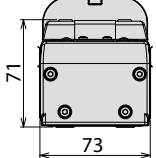
	Cleanroom type [ERC3CR]								Simple, dustproof type (stainless sheet type) [ERC3D]									
Type	Slider type																	
	SA5C				SA7C				SA5C				SA7C					
External view																		
Section view (mm)																		
Stroke (mm)	50~800								50~800									
Ball screw lead (mm)	3	6	12	20	4	8	16	24	3	6	12	20	4	8	16	24		
Maximum speed*1 (mm/s)	225	450	900	1120	210	490	980	1200	225	450	900	1120	210	490	980	1200		
Maximum payload*2 (kg)	Horizontal		20	18	9	6.5	45	40	35	17	20	18	9	6.5	45	40	35	17
	Vertical		12	6	2.5	1	22	14	6	3	12	6	2.5	1	22	14	6	3
Page	P.15				P.17				P.19				P.21					

(Notes) The above values are all based on operating each unit at an acceleration/deceleration of 0.3 G with the high-output setting enabled.

*1 The maximum speed may not be reached when the stroke is shorter. Also note that the longer the stroke, the lower the maximum speed becomes in order to avoid reaching a dangerous speed. For details, refer to the specification page of each model.

*2 The maximum payload is based on operation at the rated acceleration. The higher the acceleration, the lower the maximum payload becomes. For details, refer to the table of payloads by acceleration on P.32.

Standard type [ERC3]																	
Type	Slider type								Rod type								
	SA5C				SA7C				RA4C				RA6C				
External view																	
Section view (mm)																	
Stroke (mm)	50~800								50~300								
Ball screw lead (mm)	3	6	12	20	4	8	16	24	3	6	12	20	4	8	16	24	
Maximum speed*1 (mm/s)	225	450	900	1120	210	490	980	1200	225	450	700	800	210	420	700	800	
Maximum payload*2 (kg)	Horizontal	20	18	9	6.5	45	40	35	17	40	40	25	6	70	55	40	13
	Vertical	12	6	2.5	1	22	14	6	3	18	12	4.5	1.5	25	17.5	8	3
Page	P.23				P.25				P.27				P.29				

(Notes) The above values are all based on operating each unit at an acceleration/deceleration of 0.3 G with the high-output setting enabled.

*1 The maximum speed may not be reached when the stroke is shorter. Also note that the longer the stroke, the lower the maximum speed becomes in order to avoid reaching a dangerous speed. For details, refer to the specification page of each model.

*2 The maximum payload is based on operation at the rated acceleration. The higher the acceleration, the lower the maximum payload becomes. For details, refer to the table of payloads by acceleration on P.32.

How to Select Your Controller

The lineup of ERC3 built-in controllers is shown below.

● Controller Types

CON type	<ul style="list-style-type: none"> Up to 16 positioning points
MEC type	<ul style="list-style-type: none"> 2 or 3 positioning points (Same controls possible with an air cylinder can be achieved.) Quick Teach supported

● Operation Modes

Positioner mode	Normal operation (Move the actuator by specifying position numbers through a PLC, etc.)
Pulse-train control mode	Move the actuator using pulse signals from a host controller.

● I/O Types

PIO type	NPN	NPN specification (Standard)
	PNP	PNP specification
SIO type	<ul style="list-style-type: none"> Can increase the number of positioning points to a maximum of 512 using the PIO converter, or can use the ERC3 as a simple absolute unit Can access field networks using the gateway unit 	

● Types of ERC3 and Supported Tools

Controller type	Operation mode	I/O type		Model number (I/O type)	Teaching pendant			PC software			PIO converter	Gateway unit	Remarks
					CON-PTA	Quick Teach RCM-PST	SEP-PT	RCM-101-MW	RCM-101-USB	MEC PC software			
CON type	Positioner mode	PIO	NPN	NP	○	△ *1	—	○	○	—	—	—	Basic type (Refer to the page on the right.)
			PNP	PN	○	△ *1	—	○	○	—	—	—	Overseas specification
	SIO	SE	○	△	—	○	○	—	○	○	When the PIO converter or gateway unit is used (At least one is required.)		
	Pulse-train control mode	NPN	PLN	○	△ *1	—	○	○	—	—	—	When pulse-train control is used	
PNP		PLP	○	△ *1	—	○	○	—	—	—			
MEC type	Positioner mode	SIO	SE	○	○	○	—	—	○	—	—	Basic type when the Quick Teach is used (Refer to the page on the right.)	

○ : All functions are supported, △ : Limited functions are supported (Effective functions: Home return, Servo ON/OFF, JOG+, JOG-, Stop (Press and hold to reset the alarm))

*1 The SIO communication cable (for Quick Teach) (CB-PST-SIO050) must be purchased separately.

(Note) The PIO converter and gateway unit cannot be used at the same time.

The basic types of ERC3 built-in controllers are listed below.
Select one of the following types for any standard application.

① Basic type



Controller type	CON type (Up to 16 positioning points)
Operation mode	Positioner mode
I/O type	PIO type

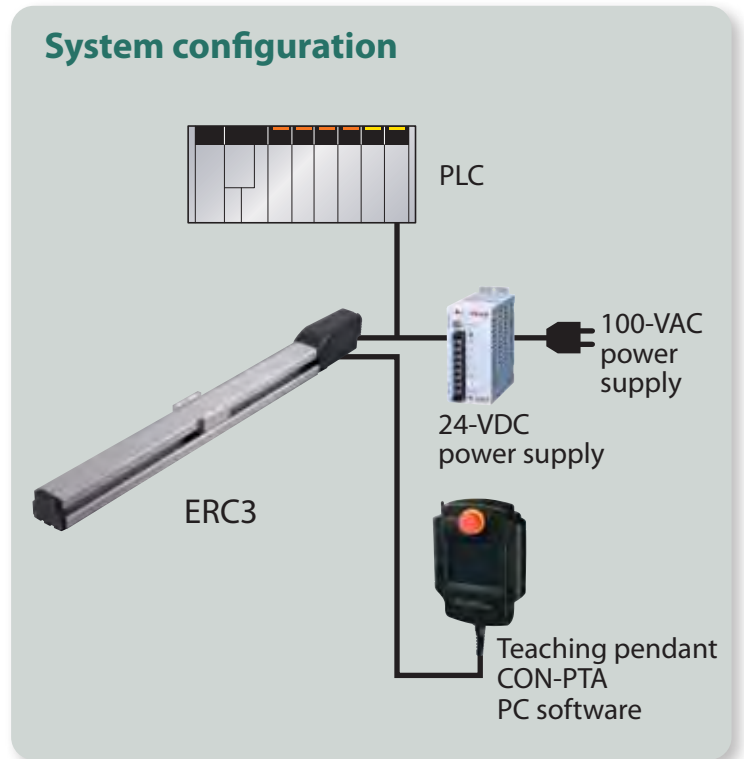

② Basic type when the Quick Teach is used



Quick Teach (Refer to P. 7 and 51.)

Controller type	MEC type (2 or 3 positioning points)
Operation mode	Positioner mode
I/O type	SIO type

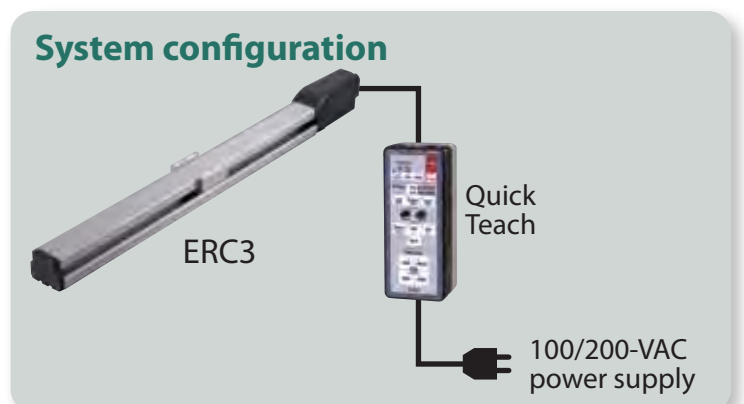

Quick Teach → P.51

Features

- 1 The ERC3 can be operated without a separate 24-V power supply.**

The Quick Teach lets you operate your actuator with ease simply by operating the buttons and dials on the operation panel without having to supply a separate 24V power supply or send signals from a PLC. With the Quick Teach, you can change the number of stop positions (between 2 and 3), change the stop position, speed and acceleration, or perform trial operation (forward/reverse, continuous operation).

* The above functions are enabled when the ERC3 controller is of the "MEC" type. Only JOG operation can be performed when the controller is of the "CON" type.

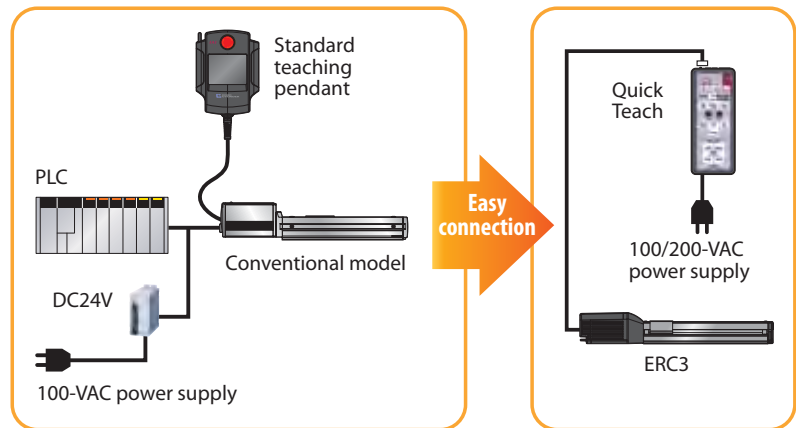

- 2 The acceleration/speed can be changed.**

- 3 JOG operation is supported and positions can be set (the stop positions can be changed).**

- 4 The actuator can be operated without a PLC, which means that a simple system can be made at low cost.**

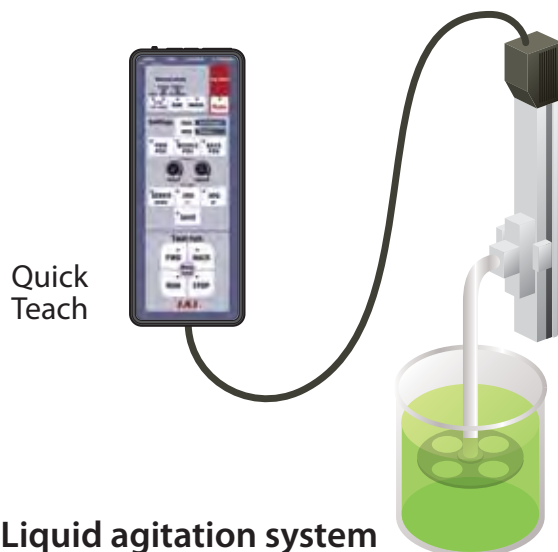

The system for agitating chemical solutions and other liquids uses an ERC3 and the Quick Teach. The system can be operated and a desired run-out or speed set without using a PLC.

Explanation of the Operation Panel

HOME button

When the actuator is started, home return is performed first to confirm the coordinate position of 0mm.

MANUAL button

Press this button (and hold it for at least 1 second) to set the acceleration/speed or perform a test run.

AUTO button

Pressing this button disables the operation and all inputs from the operation panel buttons. It also enables PIO commands to the ERC3.

STOP POS NUM button

Press this button (and hold it for at least 1 second) to switch the number of positions between 2 and 3.

TEACH MODE button

Use this button to switch between modes 1 and 2 below:
 1. Acceleration/speed
 2. Acceleration/speed/position

Acceleration/Deceleration and Speed Settings

Use buttons in this area to set how you want the actuator to move.

FWD POS / MIDDLE POS / BACK POS buttons

buttons

Switch to a desired movement (among the following types):

FWD POS: The actuator moves toward the end position.

BACK POS: The actuator moves toward the home position.

MIDDLE POS: The actuator moves toward the middle position.

ACCEL / SPEED knobs

You can turn these knobs to change the actuator speed and acceleration within a range of 1% to 100% of the maximum speed and rated acceleration/ deceleration, respectively.

* The minimum speed may not be 1% of the maximum speed. For the minimum speed, refer to the operation manual.

SERVO ON/OFF button

Use this button to turn on/off the motor power.

JOG- / JOG+ buttons

Use these buttons to jog the actuator in the negative and positive directions.

SAVE button

Pressing this button saves the speed, acceleration and position adjusted above.

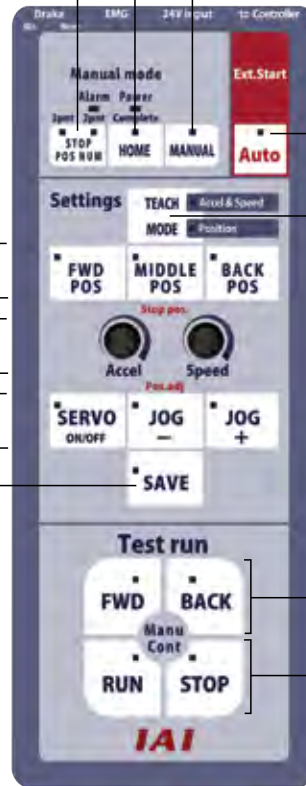

Test run

Use buttons in this area to actually move the actuator and check the saved operation.

FWD button

In a 2-position travel, the actuator moves from the BACK position to the FWD position.

In a 3-position travel, the actuator moves from the BACK position to the middle position, then to the FWD position.

BACK button

The actuator returns to the home position.

RUN button

In a 2-position travel, the actuator moves back and forth between the FWD and BACK positions.

In a 3-position travel, the actuator repeats its movement from the BACK position, middle position, FWD position, then BACK position.

STOP button

Stops the above operation.



Explanation of Terms

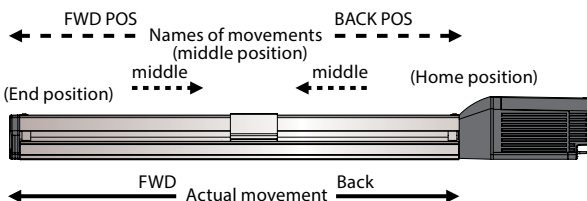

Operation Method

Changing the acceleration/speed

- ① Press and hold the **MANUAL** button.
- ② Press the **HOME** button.
- ③ Confirm that the **Accel & Speed** LED is lit.
- ④ Press the button corresponding to the stop position (**FWD POS/MIDDLE POS/BACK POS**) where you want to change the acceleration/speed.
*The **MIDDLE POS** button is available when the actuator is stopping at three positions.
- ⑤ Turn the **Accel/Speed** knobs.
*You can use the knobs to change the acceleration and speed within a range of 1% to 100% of the rated acceleration/deceleration and maximum speed, respectively. The minimum speed may not be 1% of the maximum speed, depending on the actuator. Refer to the operation manual for the minimum speed.
- ⑥ Press the **SAVE** button.

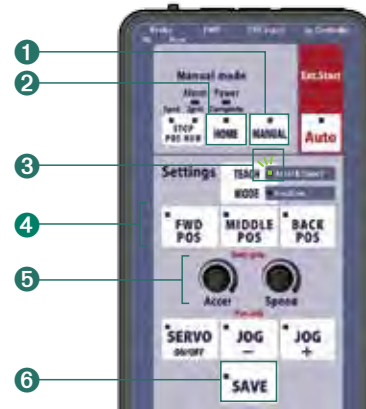

Changing the position

- ① Press and hold the **MANUAL** button.
- ② Press the **HOME** button.
- ③ Press the **STOP POS NUM** button and determine the number of stop positions.
- ④ Press the **TEACH MODE**. (Both the Accel & Speed LED and Position LED should illuminate.)
- ⑤ Press the button corresponding to the stop position (**FWD POS/MIDDLE POS/BACK POS**) where you want to change the position.
*The **MIDDLE POS** button is available when the actuator is stopping at three positions.
- ⑥ Move the actuator to a desired position.
*You can jog the actuator or turn off the servo and move the actuator by hand.
- ⑦ Press the **SAVE** button.
*Exercise caution because the conditions of the **Accel/Speed** knobs will also be saved together with the position.

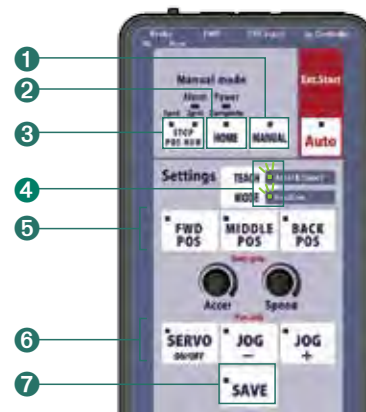

Performing test run (continuous operation)

- ① Press and hold the **MANUAL** button.
- ② Press the **HOME** button.
- ③ Press the **RUN** button.
* The actuator will move back and forth between the "forward position and back position" if it has been set to stop at two positions.
The actuator will move repeatedly in the sequence of "forward position → middle position → back position → forward position" if it has been set to stop at three positions.
- ④ Press the **STOP** button to stop the operation.

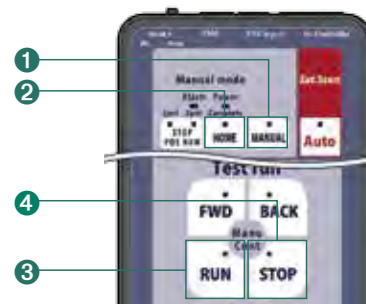

Application Examples **ERC3**

Slider type

Inkjet printer system

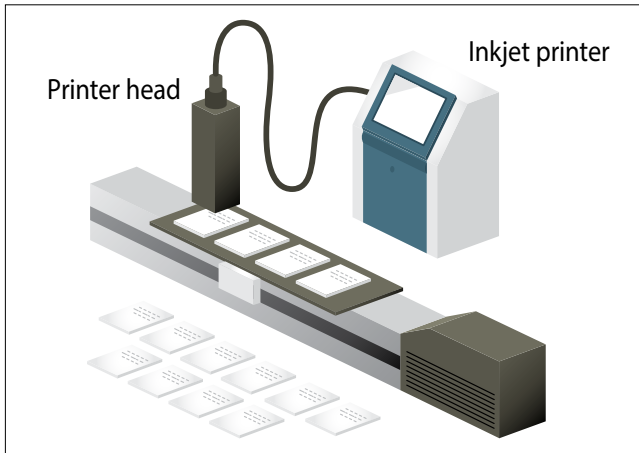

This system prints on components using an inkjet printer. The ERC3 is used to move components. Since the ERC3 can operate at a constant speed, stable printing quality can be achieved.

Component palletizing system

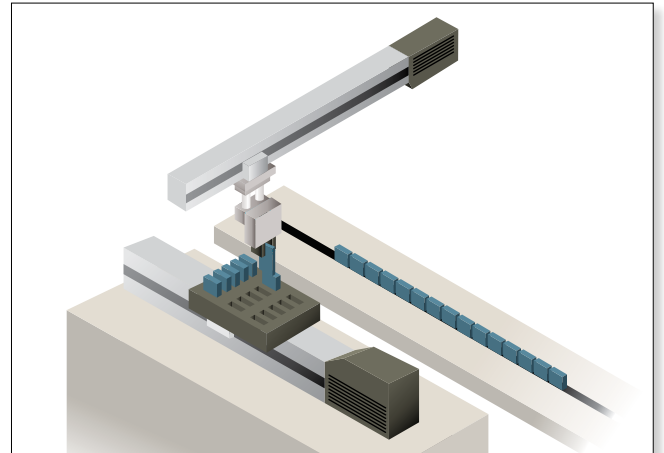

This ERC3-based system palletizes automobile components. Two axes are arranged separately to pick components and place them onto the pallet. The takt time can be reduced by performing approach and return at high speed and placement at low speed.

Rod type

Product life testing system

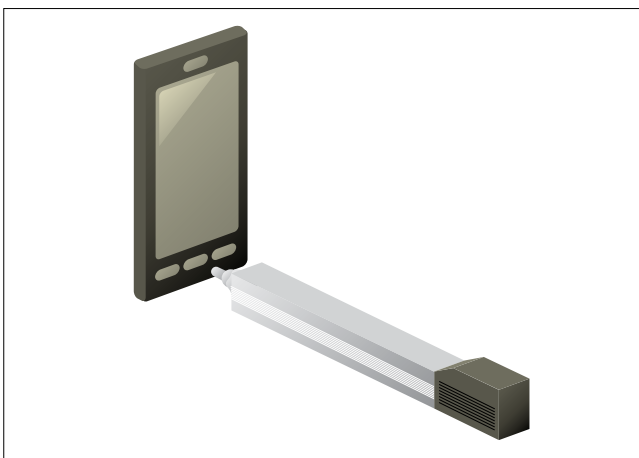

This ERC3-based system conducts life testing on electronic equipment. The push speed and force can be changed according to the product.

Work part alignment system

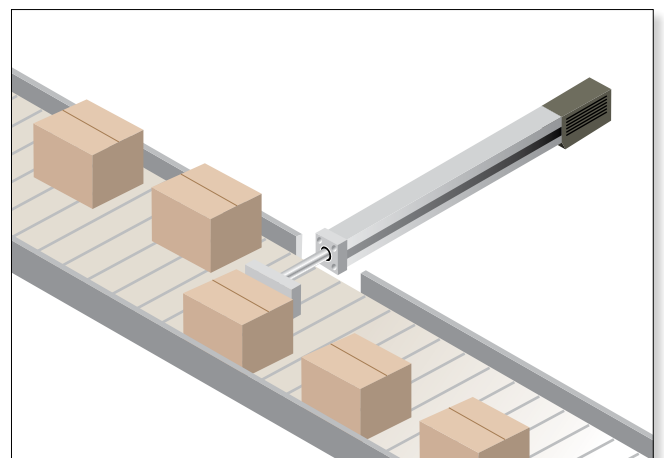

Cardboard boxes transported on the conveyor are pushed to one side and aligned.

Explanation of the Model Specification Items

The model number consists of the items specified below.

For the description of each item, refer to the applicable explanation provided below. Since the available selections (for lead, stroke, etc.) vary depending on the type, check the details on the page where each type is explained.

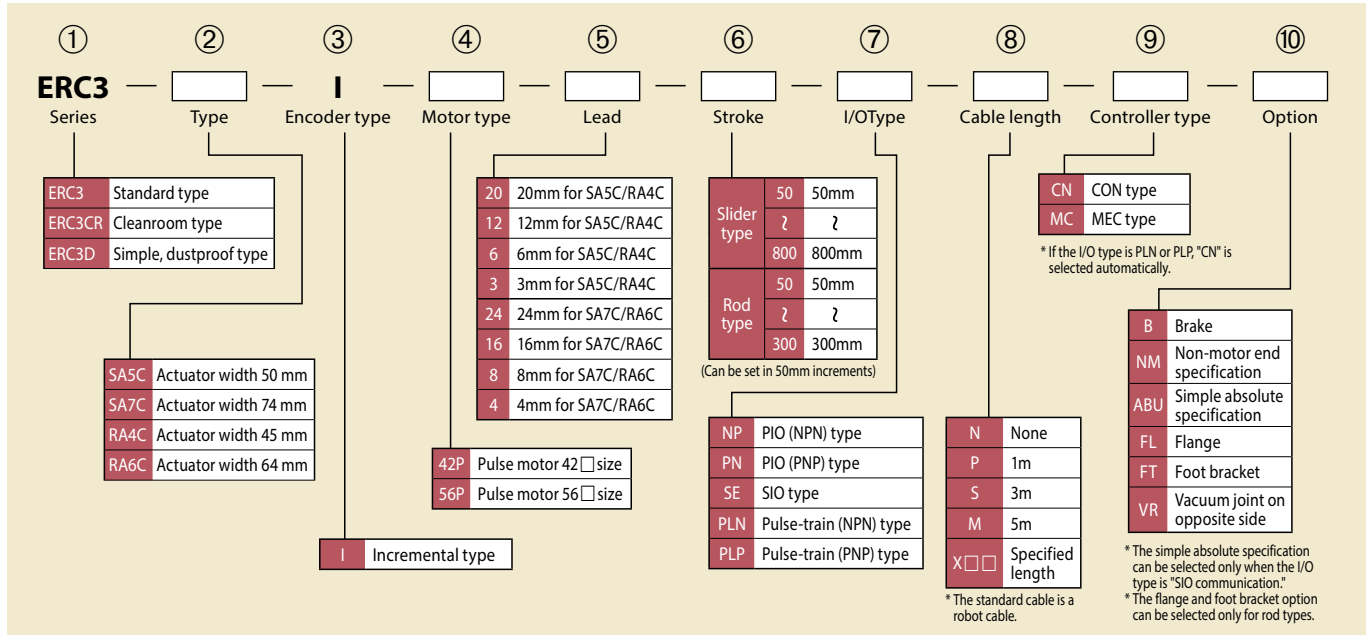

Explanation of items

① Series	Name of each series.										
② Type	The ERC3 series consists of the following four types of actuators. <table border="1"> <thead> <tr> <th>Type</th> <th>Actuator width</th> </tr> </thead> <tbody> <tr> <td>SA5C</td> <td>50mm</td> </tr> <tr> <td>SA7C</td> <td>74mm</td> </tr> <tr> <td>RA4C</td> <td>45mm</td> </tr> <tr> <td>RA6C</td> <td>64mm</td> </tr> </tbody> </table>	Type	Actuator width	SA5C	50mm	SA7C	74mm	RA4C	45mm	RA6C	64mm
Type	Actuator width										
SA5C	50mm										
SA7C	74mm										
RA4C	45mm										
RA6C	64mm										
③ Encoder type	Encoder equipped in the actuator. I: Incremental type Since the slider's position data is lost once the power is turned off, home return must be performed every time the power is turned on.										
④ Motor type	Wattage of the motor installed in the actuator. Since the ERC3 series is driven by a pulse motor, the motor size (42P = 42 frame size motor) is indicated instead of the wattage.										
⑤ Lead	Lead of the ball screw (distance travelled by the slider as the ball screw makes one rotation).										
⑥ Stroke	Stroke (range of operation) of the actuator (unit: mm).										
⑦ I/O type	Type of connectable controllers. With the ERC3 series having a built-in controller, the I/O (input/output signal) type is indicated.										
⑧ Cable length	Length of the cable that connects the ERC3 series with the host system and options.										
⑨ Controller type	Two types of controllers are available: <ul style="list-style-type: none"> • CON type: At least eight positioning points (or at least 64 points when the PIO converter is used) are supported. • MEC type: The actuator can be operated with ease. As for positioning, the actuator stops at two points or three positions. (Note) Switching between the CON type and MEC type is not possible after the shipment.										
⑩ Option	Options installed on the actuator. Refer to P. 12 for details. *If multiple options are selected, enter them in an alphabetic order. (Example: ABU-B-NM)										

Actuator Options

Brake
Model number: B

Applicable models All models

Description A mechanism to hold the slider in place when the actuator is used vertically, so that it will not drop and damage the work part, etc., when the power or servo is turned off.

Non-motor end specification
Model number: NM

Applicable models All models

Description Select this option if you want to change the home position of the actuator slider or rod from the normal position (motor side) to the front side.

Simple absolute specification
Model number: ABU

Applicable models All models

Description This option is used to allow the actuator to operate without returning home first when the power is turned on. It can be selected only when the I/O type is "SIO communication (SE)."
* The simple absolute battery is installed in the PIO converter (refer to P. 45), so the separately sold PIO converter of simple absolute specification is required.

Flange
Model number: FL

Applicable models ERC3-RA4C/RA6C

Description A bracket used to secure a rod actuator from the actuator side. The flange can be purchased separately later on.

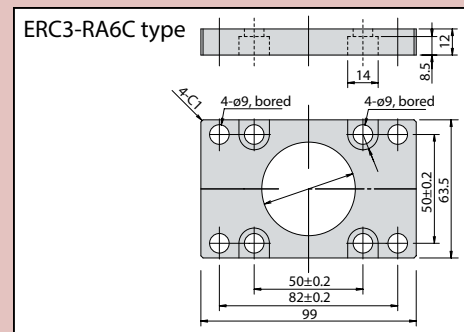
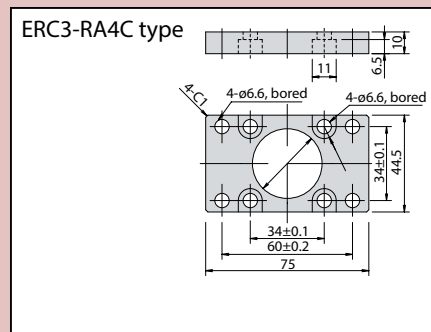

Foot bracket
Model number: FT

Applicable models ERC3-RA4C/RA6C

Description This bracket is used to affix the rod type with bolts from above the actuator. The bracket can be purchased separately later on.

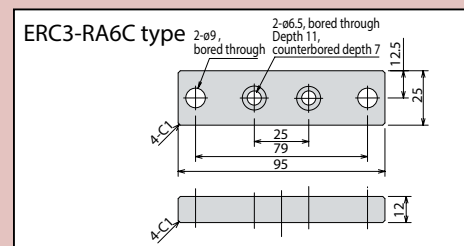
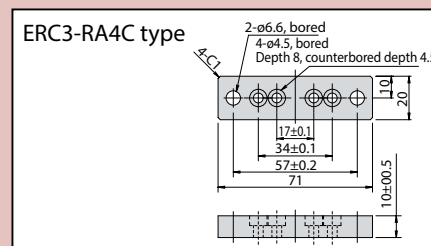

Vacuum joint on opposite side
Model number: VR

Applicable models ERC3CR-SA5C/SA7C

Description Under the standard specification, the vacuum joint is installed on the left side of the actuator as viewed from the motor. When this option is selected, the position of this joint is moved to the right side (opposite side).

1. Speed

"Speed" refers to the set speed at which to move the actuator slider (or rod).

After accelerating from the stationary state and reaching the set speed, the slider continues to move at that speed until immediately before the target position (specified position) and then decelerates to a stop.

<Caution>

- ❶ The pulse motors used in the ERC3 series change their maximum speed depending on the transported mass. When selecting your model, refer to "Correlation diagrams of speed vs. payload" (on the page featuring each model).
- ❷ Regardless of whether the stroke is short or long, the set speed may not be reached if the travel distance is short.
- ❸ The longer the stroke, the lower the maximum speed becomes in order to avoid reaching a dangerous speed. For details, refer to the "Stroke vs. Maximum Speed" table on the page featuring each model.
- ❹ When calculating the travel time, consider not only the travel time at the set speed, but also the acceleration, deceleration and settling times.

2. Acceleration/Deceleration

"Acceleration" refers to the rate of change in speed until the stationary actuator reaches the set speed.

"Deceleration" refers to the rate of change in speed until the actuator traveling at the set speed comes to a stop.

Both are specified in "G" in programs (0.3 G = 2940 mm/sec²).

<Caution>

- ❶ The greater the value of acceleration (deceleration), the faster the actuator accelerates (decelerates) and consequently the travel time becomes shorter.
Note, however, that an excessively higher acceleration (deceleration) is a cause of error and malfunction.
- ❷ The rated acceleration (deceleration) is 0.3 G.
Although the upper limit of acceleration (deceleration) is 1 G (or 0.5 G in a vertical application), increasing the value of acceleration/deceleration reduces the payload.

3. Duty

With the ERC3 series, the duty is limited according to the ambient temperature to prevent the motor unit from generating heat. Operate the actuator at a duty ratio not exceeding the allowable value shown in the graph below.

<Caution>

The duty limits shown below assume that the high-output setting of the controller is enabled. If the high-output setting is disabled, the payload and maximum speed become lower, but the actuator can be used at a duty of 100%. Refer to the operation manual for information on how to change the high-output setting.

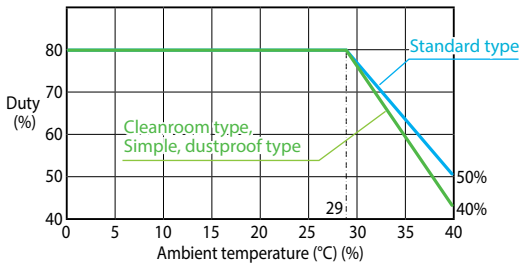

The duration of one cycle shall be assumed as follows:

Model	Duration of 1 cycle (T _M + T _R)
SA5C/RA4C	15 minutes or less
SA7C/RA6C	10 minutes or less

Notes:

Do not operate the actuator at a duty ratio exceeding the allowable value. If the actuator is operated at a duty ratio exceeding the allowable value, the life of the capacitor used in the controller will become shorter.

[Duty ratio]

"Duty ratio" refers to the utilization ratio indicated by a percentage of the time during which the actuator operates in one cycle.

$$D = \frac{T_M}{T_M + T_R} \times 100(\%)$$

D: Duty
T_M: Operating time (including push-motion operation)
T_R: Stationary time

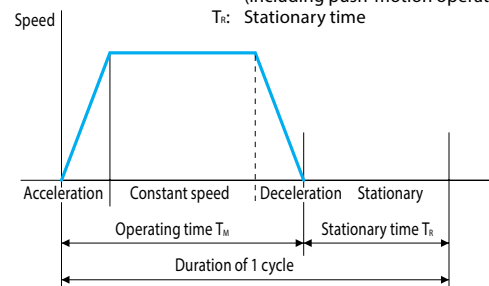

4. Installation

Refer to the table below for the installation orientation of each model.

○: Can be installed

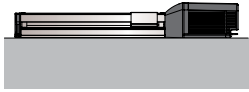
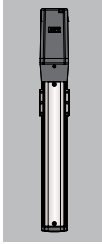
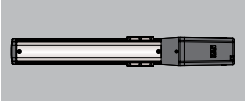
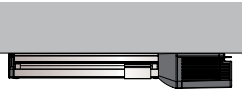
Installation orientation	Horizontal, flat	Vertical Note 1	Laid on side	Ceiling mount
				
Type				
SA5C, SA7C	○	○	○ ^{Note 2}	○
RA4C, RA6C	○	○	○	○
Slider type, standard specification (Screw cover specification) (SA5C, SA7C)	○	○	○	○
Slider type, standard specification (Stainless sheet specification) (SA5C, SA7C)	○	○	△	△
Slider type, cleanroom type (SA5C, SA7C)	○	○	△	△
Rod type (RA4C, RA6C)	○	○	○	○

Note 1 When installing the actuator vertically, bring the motor to the top whenever possible. If the actuator is mounted with the motor at the bottom, problems won't occur during normal operation, but if the actuator is stopped for a prolonged period of time, grease may separate depending on the ambient environment (especially when the ambient temperature is high), in which case base oil may flow into the motor unit and could cause problems on rare occasions.

Note 2 If the actuator is installed on its side, it becomes more vulnerable to entry of foreign matters into the actuator or scattering of grease on the guide and ball screw from openings on the exposed side.

Note 3 The slider type of standard specification (stainless specification) or cleanroom type SA5C/SA7C can be installed sideways or hung from the ceiling, but the actuator must be inspected daily. This is because when the actuator is laid on its side or mounted from the ceiling, the stainless sheet may become loose or shift. If the actuator is used continuously in this condition, the stainless sheet may fracture or develop other problems. Inspect your actuator daily and if the stainless sheet is found loose or shifted, adjust the installation of the stainless sheet.

ERC3CR-SA5C

- Cleanroom type ● Slider type
- Actuator Width 50mm

Model Specification Items	ERC3CR-SA5C	I	42P							
	Series	Type	Encoder type	Motor type	Lead	Stroke	I/O type	Cable length	Controller type	Option
			I: Incremental specification	42□ Pulse motor	20: 20mm 12: 12mm 6: 6mm 3: 3mm	50: 50mm ? 800: 800mm (Can be set in 50mm increments)	NP: PIO (NPN) type PN: PIO (PNP) type SE: SIO type PLN: Pulse-train (NPN) type PLP: Pulse-train (PNP) type	N: None P: 1m S: 3m M: 5m X□□: Specified length	CN: CON type MC: MEC type	B : Brake NM : Non-motor end specification ABU: Simple absolute specification VR: Vacuum joint on opposite side

*Refer to P.11 for the description of items constituting the model number.

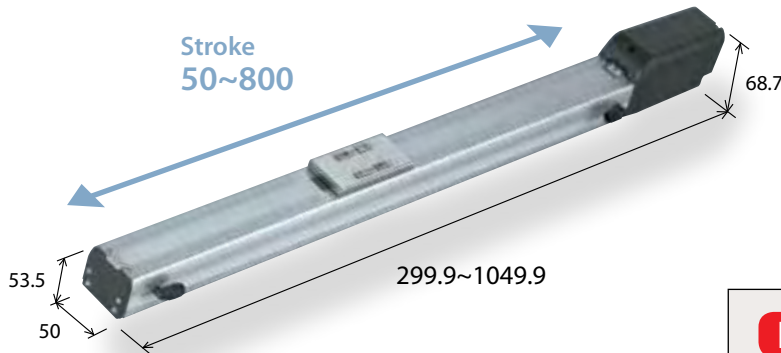

POINT Notes on selection

If the high-output setting is enabled (factory default), the duty must be limited. (Refer to P.13.) If the high-output setting is disabled, the payload and maximum speed become lower, but the actuator can be used at a duty of 100%. Refer to the operation manual for information on how to change the high-output setting. Refer to P.32 for the payload at each speed/acceleration when the high-output setting is enabled. Refer to P.33 for the specifications that apply when the high-output setting is disabled.

For other cautionary items, refer to "Explanations of/Cautionary Notes on Items Specified in Catalog (P.13)."

Correlation diagrams of Speed and Payload

With the ERC series, due to the characteristics of the pulse motor, payload decreases as the speed increases. Use the chart below to confirm that the desired speed and payload requirements are met.

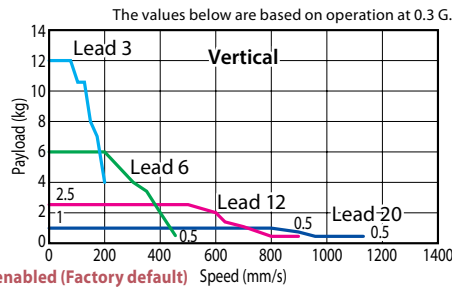
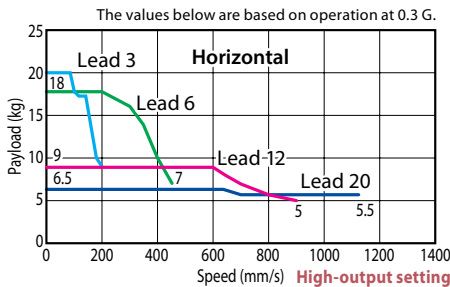

Actuator Specifications (High-output Setting Enabled)

Leads and Payloads

(Note 1) Take caution that the maximum payload decreases as the speed increases.

Model number	Lead (mm)	Maximum payload (Note 1)		Stroke (mm)
		Horizontal (kg)	Vertical (kg)	
ERC3CR-SA5C-I-42P-20-①-②-③-④	20	6.5	1	50~800 (every 50mm)
ERC3CR-SA5C-I-42P-12-①-②-③-④	12	9	2.5	
ERC3CR-SA5C-I-42P-6-①-②-③-④	6	18	6	
ERC3CR-SA5C-I-42P-3-①-②-③-④	3	20	12	

Legend ① Stroke ② I/O type ③ Cable length ④ Option

Stroke and Maximum Speed/Suction Amount by Lead

Lead	Stroke (every 50mm)	500 (mm)	550 (mm)	600 (mm)	650 (mm)	700 (mm)	750 (mm)	800 (mm)	Suction amount (NI/min)
20	1120	1045	900	785	690	610	80		
12	900	795	665	570	490	425	375	50	
6	450	395	335	285	245	215	185	165	30
3	225	195	165	140	120	105	90	80	15

The values of lead 3 apply when acceleration is at 0.1G.

(Unit: mm/s)

① Stroke

Stroke (mm)	Standard price	Stroke (mm)	Standard price
50	—	450	—
100	—	500	—
150	—	550	—
200	—	600	—
250	—	650	—
300	—	700	—
350	—	750	—
400	—	800	—

③ Cable length

Type	Cable symbol	Standard price	
		PIO type	SIO type
Standard type (Robot cable)	P (1m)	—	—
	S (3m)	—	—
	M (5m)	—	—
Special length	X06(6m)~X10(10m)	—	—

*Refer to P.44 for maintenance cables.

④ Options

Name	Option code	See page	Standard price
Brake	B	→P12	—
Non-motor end specification	NM	→P12	—
Vacuum joint on opposite side	VR	→P12	—
Simple absolute specification	ABU	→P12	— (*)

(*) If the simple absolute specification is selected, the separately sold PIO converter of simple absolute specification (with battery) is required.

Dimensional Drawings

CAD drawings can be downloaded from the website.

www.intelligentactuator.com



Offset reference position for moments (*3)

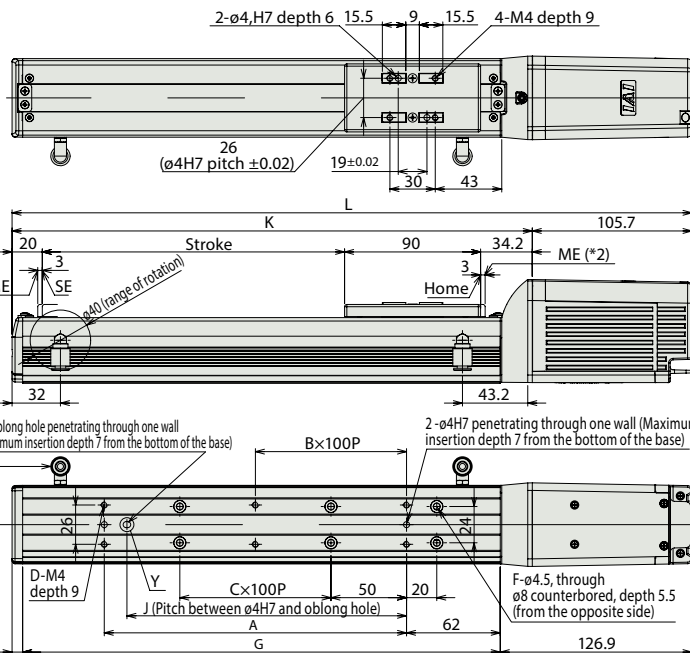
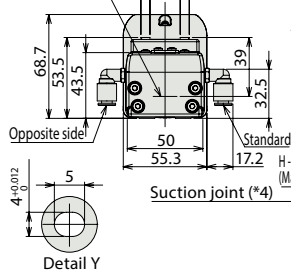

*4 Outer diameter of suction joint tube: $\phi 6$

*1 Connect the power & I/O cable. Refer to P.44 for details on this cable SE: Stroke End ME: Mechanical End

*2 The slider moves to the ME during home return, so pay attention to possible contact with surrounding structures.

*3 Reference position is used when calculating the Ma and Mc moments

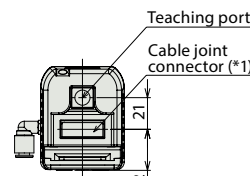

External view of the brake specification

The overall length of the brake specification is 42.5mm longer than the standard specification and its mass is 0.4 kg heavier.

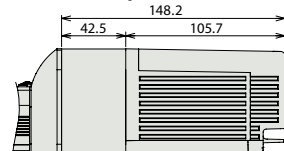

Actuator specification

Item	Description
Drive system	Ball screw $\phi 10$ mm, rolled C10
Positioning repeatability (*1)	± 0.02 mm [± 0.03 mm]
Lost motion	0.1 mm or less
Static allowable load moment	Ma: 29.4 N·m, Mb: 42.0 N·m, Mc: 60.5 N·m
Dynamic allowable load moment (*2)	Ma: 7.1 N·m, Mb: 10.2 N·m, Mc: 14.7 N·m
Overhang load lengths	150mm or less in Ma direction, 150 mm or less in Mb and Mc directions
Ambient operation temperature, humidity	0 to 40°C, 85% RH or less (Non-condensing)

(*1) The specification in [] applies when the lead is 20 mm.

(*2) Based on 5,000 km of traveling life.

Allowable load moment directions

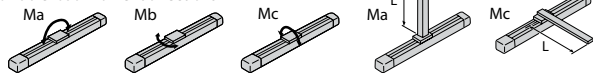

Dimensions and Mass by Stroke

Stroke	50	100	150	200	250	300	350	400	450	500	550	600	650	700	750	800
L	299.9	349.9	399.9	449.9	499.9	549.9	599.9	649.9	699.9	749.9	799.9	849.9	899.9	949.9	999.9	1049.9
A	73	100	100	200	200	300	300	400	400	500	500	600	600	700	700	800
B	0	0	0	1	1	2	2	3	3	4	4	5	5	6	6	7
C	0	0	1	1	2	2	3	3	4	4	5	5	6	6	7	7
D	4	4	4	6	6	8	8	10	10	12	12	14	14	16	16	18
F	4	4	6	6	8	8	10	10	12	12	14	14	16	16	18	18
G	166	216	266	316	366	416	466	516	566	616	666	716	766	816	866	916
H	0	1	1	1	1	1	1	1	1	1	1	1	1	1	1	1
J	0	85	85	185	185	285	285	385	385	485	485	585	585	685	685	785
K	194.2	244.2	294.2	344.2	394.2	444.2	494.2	544.2	594.2	644.2	694.2	744.2	794.2	844.2	894.2	944.2
Mass (kg)	1.6	1.8	2.0	2.1	2.3	2.5	2.6	2.8	3.0	3.1	3.3	3.5	3.6	3.8	4.0	4.1

Controllers (Built into the Actuator)

@I/O type

With the ERC3 series, one of the following five types of built-in controllers can be selected depending on the external input/output (I/O) type. Select the type that meets your purpose.

Name	External view	Model number	Features	Maximum number of positioning points	Input power	Power supply capacity	Standard price	Reference page
PIO type (NPN specification)		ERC3CR-SA5C-I-42P-□-□-NP-□-□	Simple control type accommodating up to 16 positioning points	16	DC24V	High-output setting enabled: 3.5A rated 4.2A max. High-output setting disabled: 2.2A	—	→P35
PIO type (PNP specification)		ERC3CR-SA5C-I-42P-□-□-PN-□-□	I/O type supporting inputs/outputs of the PNP specification often used overseas	16				
SIO type		ERC3CR-SA5C-I-42P-□-□-SE-□-□	High-function type accommodating up to 512 positioning points (PIO converter is used)	512				
Pulse-train type (NPN specification)		ERC3CR-SA5C-I-42P-□-□-PLN-□-□	Pulse-train input type supporting the NPN specification	—				
Pulse-train type (PNP specification)		ERC3CR-SA5C-I-42P-□-□-PLP-□-□	Pulse-train input type supporting the PNP specification	—				

ERC3CR-SA7C

- Cleanroom type
- Slider type
- Actuator Width 73mm

■ Model Specification Items

ERC3CR-SA7C-I-56P

Series — Type — Encoder type — Motor type — Lead — Stroke — I/O type — Cable length — Controller type — Option

I: Incremental specification 56□ Pulse motor 24: 24mm 50:50mm } NP: PIO (NPN) type N: None P: 1m CN: CON type B : Brake

16: 16mm 800:800mm } PN: PIO (PNP) type S: 3m M: 5m MC: MEC type NM : Non-motor end

8: 8mm (Can be set in 50mm increments) SE: SIO type X□□: Specified length ABU: Simple absolute

4: 4mm PLN: Pulse-train (NPN) type PLP: Pulse-train (PNP) type VR: Vacuum joint on opposite side

*Refer to P.11 for the description of items constituting the model number.

RoHS

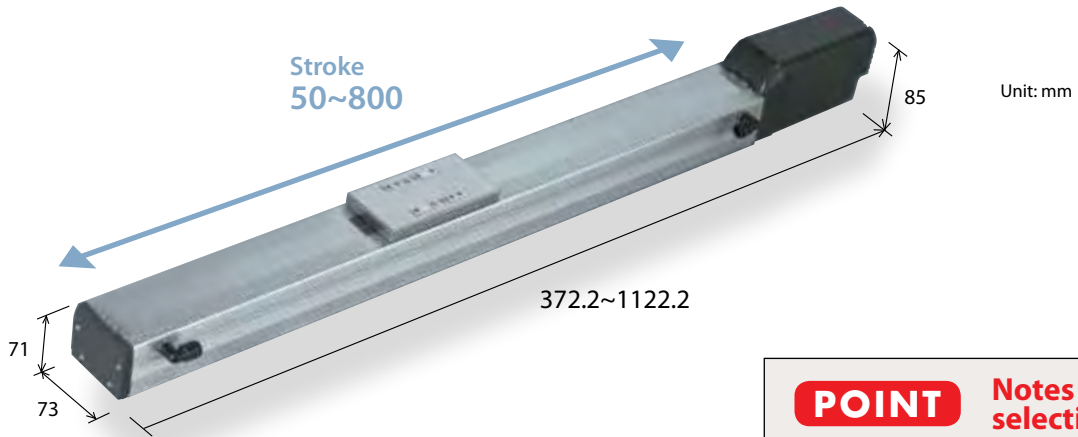

POINT Notes on selection

If the high-output setting is enabled (factory default), the duty must be limited. (Refer to P.13.) If the high-output setting is disabled, the payload and maximum speed become lower, but the actuator can be used at a duty of 100%. Refer to the operation manual for information on how to change the high-output setting. Refer to P.32 for the payload at each speed/acceleration when the high-output setting is enabled. Refer to P.33 for the specifications that apply when the high-output setting is disabled.

For other cautionary items, refer to "Explanations of/Cautionary Notes on Items Specified in Catalog (P.13)."

■ Correlation diagrams of Speed and Payload

With the ERC3 series, due to the characteristics of the pulse motor, payload decreases as the speed increases. Use the chart below to confirm that the desired speed and payload requirements are met.

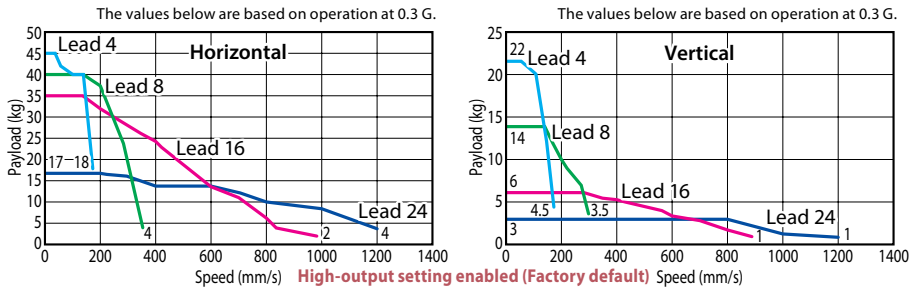

■ Actuator Specifications (High-output Setting Enabled)

■ Leads and Payloads

(Note 1) Take caution that the maximum payload decreases as the speed increases.

Model number	Lead (mm)	Maximum payload (Note 1)		Stroke (mm)
		Horizontal (kg)	Vertical (kg)	
ERC3CR-SA7C-I-56P-24-①-②-③-④	24	17	3	50~800 (every 50mm)
ERC3CR-SA7C-I-56P-16-①-②-③-④	16	35	6	
ERC3CR-SA7C-I-56P-8-①-②-③-④	8	40	14	
ERC3CR-SA7C-I-56P-4-①-②-③-④	4	45	22	

Legend ① Stroke ② I/O type ③ Cable length ④ Option

■ Stroke and Maximum Speed/Suction Amount by Lead

Stroke	50~550 (every 50mm)	600 (mm)	650 (mm)	700 (mm)	750 (mm)	800 (mm)	Suction amount (Nl/min)
24	1200	1155	1010	890	790	90	
16	980 <> 840	865 <> 840	750	655	580	515	70
8	490	430	375	325	290	255	40
4	210	185	160	145	125	30	

The value inside <> indicates vertical usage. The values of lead 8 and lead 4 apply when acceleration is at 0.1G. (Unit: mm/s)

① Stroke

Stroke (mm)	Standard price	Stroke (mm)	Standard price
50	—	450	—
100	—	500	—
150	—	550	—
200	—	600	—
250	—	650	—
300	—	700	—
350	—	750	—
400	—	800	—

③ Cable length

Type	Cable symbol	Standard price	
		PIO type	SIO type
Standard type (Robot cable)	P (1m)	—	—
	S (3m)	—	—
	M (5m)	—	—
Special length	X06(6m)~X10(10m)	—	—

*Refer to P. 44 for maintenance cables.

④ Options

Name	Option code	See page	Standard price
Brake	B	→P12	—
Non-motor end specification	NM	→P12	—
Vacuum joint on opposite side	VR	→P12	—
Simple absolute specification	ABU	→P12	— (*)

(*) If the simple absolute specification is selected, the separately sold PIO converter of simple absolute specification (with battery) is required.

Dimensional Drawings

CAD drawings can be downloaded from the website.

www.intelligentactuator.com



*4 Outer diameter of suction joint tube: ø8

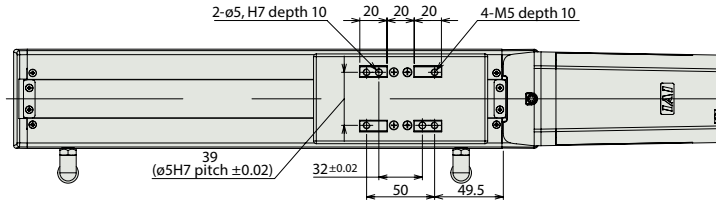

*1 Connect the power & I/O cable. Refer to P.44 for details on this cable
SE: Stroke End
ME: Mechanical End

*2 The slider moves to the ME during home return, so pay attention to possible contact with surrounding structures.

*3 Reference position is used when calculating the Ma and Mc moments

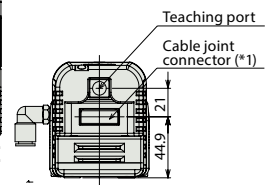
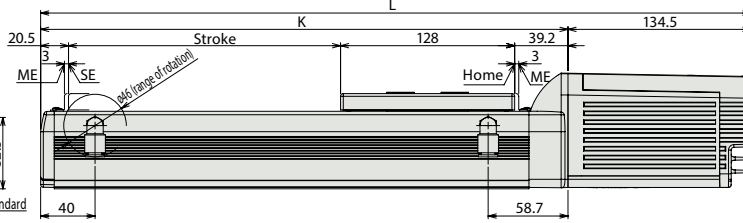
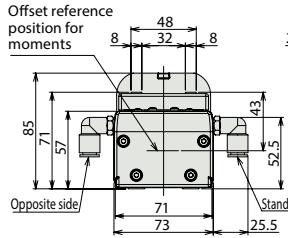

External view of the brake specification

The overall length of the brake specification is 51 mm longer than the standard specification and its mass is 0.5 kg heavier.

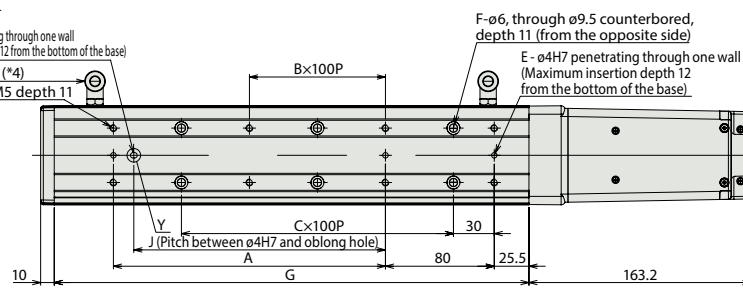
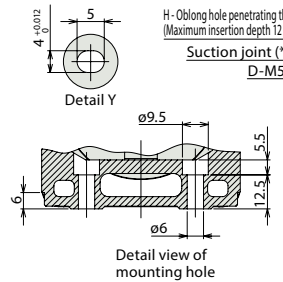
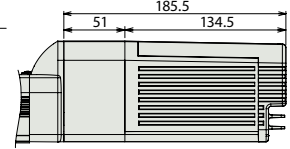

Actuator specification

Item	Description
Drive system	Ball screw ø12 mm, rolled C10
Positioning repeatability (*1)	± 0.02 mm [± 0.03 mm]
Lost motion	0.1 mm or less
Static allowable load moment	Ma: 70.0 N·m, Mb: 100.0 N·m, Mc: 159.5 N·m
Dynamic allowable load moment (*2)	Ma: 15.0 N·m, Mb: 21.4 N·m, Mc: 34.1 N·m
Overhang load lengths	150 mm or less in Ma direction, 150 mm or less in Mb and Mc directions
Ambient operation temperature, humidity	0 to 40°C, 85% RH or less (Non-condensing)

(*1) The specification in [] applies when the lead is 24 mm.

(*2) Based on 5,000 km of traveling life.

Allowable load moment directions

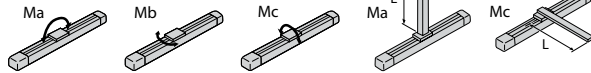

Dimensions and Mass by Stroke

Stroke	50	100	150	200	250	300	350	400	450	500	550	600	650	700	750	800
L	372.2	422.2	472.2	522.2	572.2	622.2	672.2	722.2	772.2	822.2	872.2	922.2	972.2	1022.2	1072.2	1122.2
A	0	100	100	200	200	300	300	400	400	500	500	600	600	700	700	800
B	0	0	0	1	1	2	2	3	3	4	4	5	5	6	6	7
C	1	1	2	2	3	3	4	4	5	5	6	6	7	7	8	8
D	4	6	6	8	8	10	10	12	12	14	14	16	16	18	18	20
E	2	3	3	3	3	3	3	3	3	3	3	3	3	3	3	3
F	4	4	6	6	8	8	10	10	12	12	14	14	16	16	18	18
G	199	249	299	349	399	449	499	549	599	649	699	749	799	849	899	949
H	0	1	1	1	1	1	1	1	1	1	1	1	1	1	1	1
J	0	85	85	185	185	285	285	385	385	485	485	585	585	685	685	785
K	237.7	287.7	337.7	387.7	437.7	487.7	537.7	587.7	637.7	687.7	737.7	787.7	837.7	887.7	937.7	987.7
Mass (kg)	3.6	3.9	4.1	4.4	4.7	4.9	5.2	5.5	5.7	6.0	6.3	6.5	6.8	7.1	7.3	7.6

Controllers (Built into the Actuator)

@I/O type

With the ERC3 series, one of the following five types of built-in controllers can be selected depending on the external input/output (I/O) type. Select the type that meets your purpose.

Name	External view	Model number	Features	Maximum number of positioning points	Input power	Power supply capacity	Standard price	Reference page
PIO type (NPN specification)		ERC3CR-SA7C-I-56P-□-□-NP-□-□	Simple control type accommodating up to 16 positioning points	16	DC24V	High-output setting enabled: 3.5A rated 4.2A max. High-output setting disabled: 2.2A	—	→P35
PIO type (PNP specification)		ERC3CR-SA7C-I-56P-□-□-PN-□-□	I/O type supporting inputs/outputs of the PNP specification often used overseas	16				
SIO type		ERC3CR-SA7C-I-56P-□-□-SE-□-□	High-function type accommodating up to 512 positioning points (PIO converter is used)	512				
Pulse-train type (NPN specification)		ERC3CR-SA7C-I-56P-□-□-PLN-□-□	Pulse-train input type supporting the NPN specification	—				
Pulse-train type (PNP specification)		ERC3CR-SA7C-I-56P-□-□-PLP-□-□	Pulse-train input type supporting the PNP specification	—				

ERC3D-SA5C

- Simple, dustproof type
- Slider type
- Actuator Width 50mm

Model Specification Items	ERC3D	SA5C	I	42P						
	Series	Type	Encoder type	Motor type	Lead	Stroke	I/O type	Cable length	Controller type	Option
			I: Incremental specification	42□ Pulse motor	20: 20mm 12: 12mm 6: 6mm 3: 3mm	50: 50mm ? 800: 800mm (Can be set in 50mm increments)	NP: PIO (NPN) type PN: PIO (PNP) type SE: SIO type PLN: Pulse-train (NPN) type PLP: Pulse-train (PNP) type	N: None P: 1m S: 3m M: 5m X□□: Specified length	CN: CON type MC: MEC type	B : Brake NM : Non-motor end specification ABU: Simple absolute specification

*Refer to P.11 for the description of items constituting the model number.

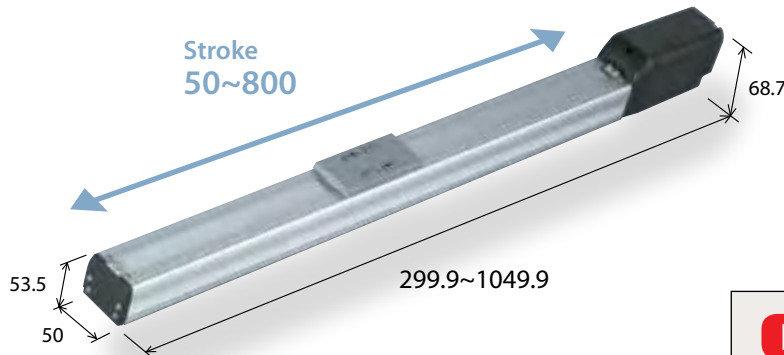

Unit: mm

POINT Notes on selection

If the high-output setting is enabled (factory default), the duty must be limited. (Refer to P.13.) If the high-output setting is disabled, the payload and maximum speed become lower, but the actuator can be used at a duty of 100%. Refer to the operation manual for information on how to change the high-output setting. Refer to P.32 for the payload at each speed/acceleration when the high-output setting is enabled. Refer to P.33 for the specifications that apply when the high-output setting is disabled.

For other cautionary items, refer to "Explanations of/Cautionary Notes on Items Specified in Catalog (P.13)."

Correlation diagrams of Speed and Payload

With the ERC3 series, due to the characteristics of the pulse motor, payload decreases as the speed increases. Use the chart below to confirm that the desired speed and payload requirements are met.

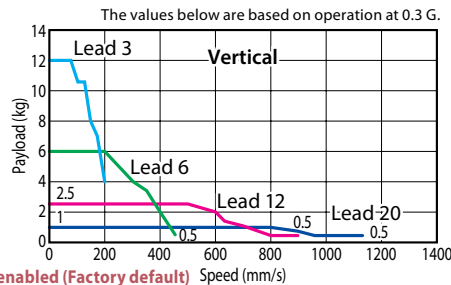
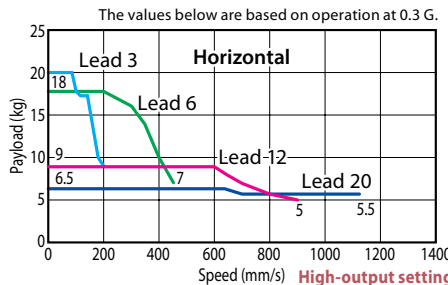

Actuator Specifications (High-output Setting Enabled)

Leads and Payloads

(Note 1) Take caution that the maximum payload decreases as the speed increases.

Model number	Lead (mm)	Maximum payload (Note 1)		Stroke (mm)
		Horizontal (kg)	Vertical (kg)	
ERC3D-SA5C-I-42P-20-①-②-③-④	20	6.5	1	50~800 (every 50mm)
ERC3D-SA5C-I-42P-12-①-②-③-④	12	9	2.5	
ERC3D-SA5C-I-42P-6-①-②-③-④	6	18	6	
ERC3D-SA5C-I-42P-3-①-②-③-④	3	20	12	

Legend ① Stroke ② I/O type ③ Cable length ④ Option

Stroke and Maximum Speed by Lead

Stroke / Lead	50~450 (every 50mm)	500 (mm)	550 (mm)	600 (mm)	650 (mm)	700 (mm)	750 (mm)	800 (mm)
20	1120			1045	900	785	690	610
12	900	795	665	570	490	425	375	330
6	450	395	335	285	245	215	185	165
3	225	195	165	140	120	105	90	80

The values of lead 3 apply when acceleration is at 0.1G.

(Unit: mm/s)

① Stroke

Stroke (mm)	Standard price	Stroke (mm)	Standard price
50	—	450	—
100	—	500	—
150	—	550	—
200	—	600	—
250	—	650	—
300	—	700	—
350	—	750	—
400	—	800	—

③ Cable length

Type	Cable symbol	Standard price	
		PIO type	SIO type
Standard type (Robot cable)	P (1m)	—	—
	S (3m)	—	—
	M (5m)	—	—
Special length	X06(6m)~X10(10m)	—	—

*Refer to P. 44 for maintenance cables.

④ Options

Name	Option code	See page	Standard price
Brake	B	→P12	—
Non-motor end specification	NM	→P12	—
Simple absolute specification	ABU	→P12	— (*)

(*) If the simple absolute specification is selected, the separately sold PIO converter of simple absolute specification (with battery) is required.

Dimensional Drawings

CAD drawings can be downloaded from the website.

www.intelligentactuator.com

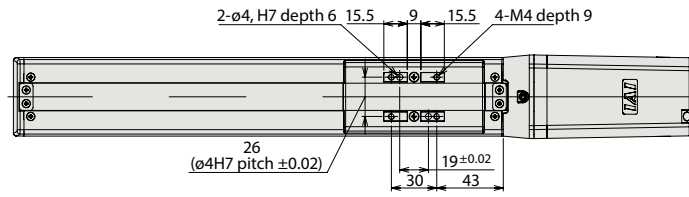

*1 Connect the power & I/O cable. Refer to P.44 for details on this cable
SE: Stroke End
ME: Mechanical End

*2 The slider moves to the ME during home return, so pay attention to possible contact with surrounding structures.

*3 Reference position is used when calculating the Ma and Mc moments

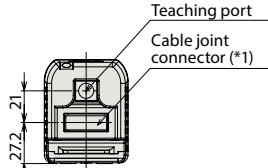
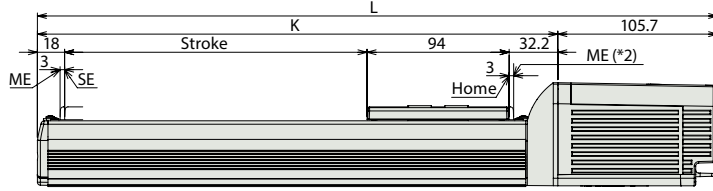
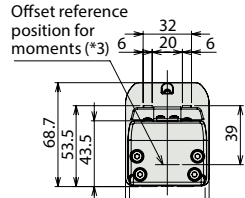

External view of the brake specification

The overall length of the brake specification is 42.5 mm longer than the standard specification and its mass is 0.4 kg heavier.

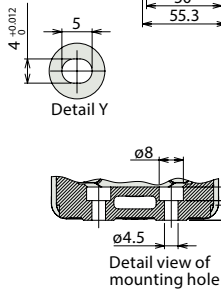
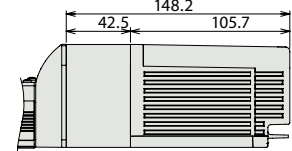

H- Oblong hole penetrating through one wall (Maximum insertion depth 7 from the bottom of the base)

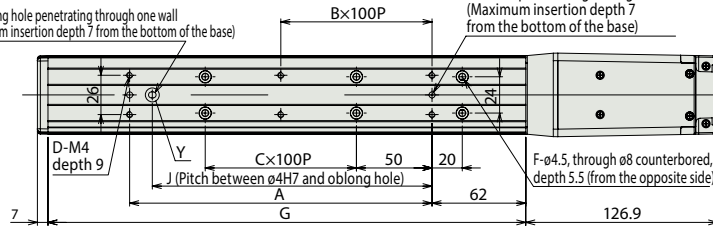

Actuator specification

Item	Description
Drive system	Ball screw ø10 mm, rolled C10
Positioning repeatability (*1)	± 0.02 mm [± 0.03 mm]
Lost motion	0.1 mm or less
Static allowable load moment	Ma: 29.4 N·m, Mb: 42.0 N·m, Mc: 60.5 N·m
Dynamic allowable load moment (*2)	Ma: 7.1 N·m, Mb: 10.2 N·m, Mc: 14.7 N·m
Overhang load lengths	150 mm or less in Ma direction, 150 mm or less in Mb and Mc directions
Ambient operation temperature, humidity	0 to 40°C, 85% RH or less (Non-condensing)

(*1) The specification in [] applies when the lead is 20 mm.

(*2) Based on 5,000 km of traveling life.

Allowable load moment directions

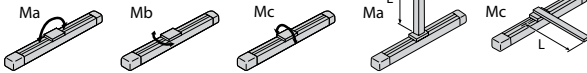

Dimensions and Mass by Stroke

Stroke	50	100	150	200	250	300	350	400	450	500	550	600	650	700	750	800
L	299.9	349.9	399.9	449.9	499.9	549.9	599.9	649.9	699.9	749.9	799.9	849.9	899.9	949.9	999.9	1049.9
A	73	100	100	200	200	300	300	400	400	500	500	600	600	700	700	800
B	0	0	0	1	1	2	2	3	3	4	4	5	5	6	6	7
C	0	0	1	1	2	2	3	3	4	4	5	5	6	6	7	7
D	4	4	4	6	6	8	8	10	10	12	12	14	14	16	16	18
F	4	4	6	6	8	8	10	10	12	12	14	14	16	16	18	18
G	166	216	266	316	366	416	466	516	566	616	666	716	766	816	866	916
H	0	1	1	1	1	1	1	1	1	1	1	1	1	1	1	1
J	0	85	85	185	185	285	285	385	385	485	485	585	585	685	685	785
K	194.2	244.2	294.2	344.2	394.2	444.2	494.2	544.2	594.2	644.2	694.2	744.2	794.2	844.2	894.2	944.2
Mass (kg)	1.6	1.8	2.0	2.1	2.3	2.5	2.6	2.8	3.0	3.1	3.3	3.5	3.6	3.8	4.0	4.1

Controllers (Built into the Actuator)

@I/O type

With the ERC3 series, one of the following five types of built-in controllers can be selected depending on the external input/output (I/O) type. Select the type that meets your purpose.

Name	External view	Model number	Features	Maximum number of positioning points	Input power	Power supply capacity	Standard price	Reference page
PIO type (NPN specification)		ERC3D-SA5C-I-42P-□-□-NP-□-□	Simple control type accommodating up to 16 positioning points	16	DC24V	High-output setting enabled: 3.5A rated 4.2A max. High-output setting disabled: 2.2A	—	→P35
PIO type (PNP specification)		ERC3D-SA5C-I-42P-□-□-PN-□-□	I/O type supporting inputs/outputs of the PNP specification often used overseas	16				
SIO type		ERC3D-SA5C-I-42P-□-□-SE-□-□	High-function type accommodating up to 512 positioning points (PIO converter is used)	512				
Pulse-train type (NPN specification)		ERC3D-SA5C-I-42P-□-□-PLN-□-□	Pulse-train input type supporting the NPN specification	—				
Pulse-train type (PNP specification)		ERC3D-SA5C-I-42P-□-□-PLP-□-□	Pulse-train input type supporting the PNP specification	—				

ERC3D-SA7C

- Simple, dustproof type
- Slider type
- Actuator Width 73mm

Model Specification Items: **ERC3D - SA7C - I - 56P**

Series	Type	Encoder type	Motor type	Lead	Stroke	I/O type	Cable length	Controller type	Option
I: Incremental specification	56□ Pulse motor	24: 24mm 16: 16mm 8: 8mm 4: 4hmm	50:50mm ? 800:800mm (Can be set in 50mm increments)	NP: PIO (NPN) type PN: PIO (PNP) type SE: SIO type PLN: Pulse-train (NPN) type PLP: Pulse-train (PNP) type	N: None P: 1m S: 3m M: 5m X□□: Specified length	CN: CON type MC: MEC type	B : Brake NM : Non-motor end specification ABU: Simple absolute specification		

*Refer to P.11 for the description of items constituting the model number.

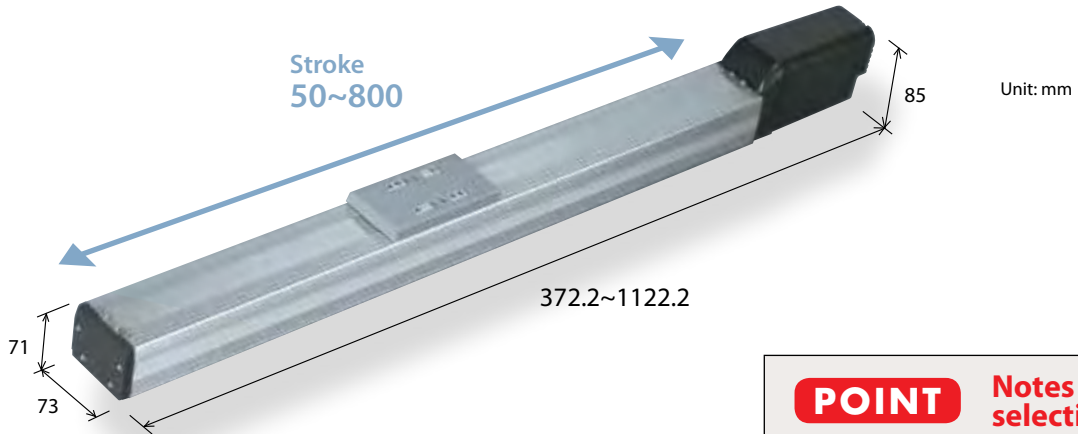

POINT Notes on selection

If the high-output setting is enabled (factory default), the duty must be limited. (Refer to P.13.) If the high-output setting is disabled, the payload and maximum speed become lower, but the actuator can be used at a duty of 100%. Refer to the operation manual for information on how to change the high-output setting. Refer to P.32 for the payload at each speed/acceleration when the high-output setting is enabled. Refer to P.33 for the specifications that apply when the high-output setting is disabled.

For other cautionary items, refer to "Explanations of/Cautionary Notes on Items Specified in Catalog (P.13)."

Correlation diagrams of Speed and Payload

With the ERC3 series, due to the characteristics of the pulse motor, payload decreases as the speed increases. Use the chart below to confirm that the desired speed and payload requirements are met.

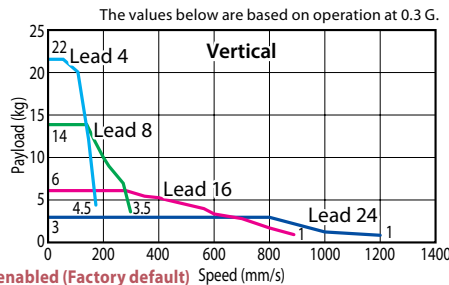
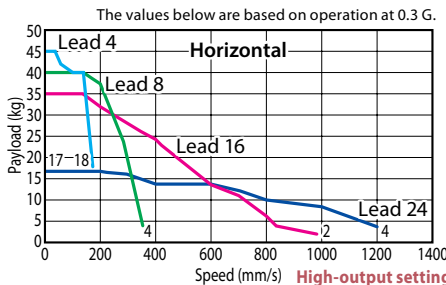

Actuator Specifications (High-output Setting Enabled)

Leads and Payloads

(Note 1) Take caution that the maximum payload decreases as the speed increases.

Model number	Lead (mm)	Maximum payload (Note 1)		Stroke (mm)
		Horizontal (kg)	Vertical (kg)	
ERC3D-SA7C-I-56P-24-①-②-③-④	24	17	3	50~800 (every 50mm)
ERC3D-SA7C-I-56P-16-①-②-③-④	16	35	6	
ERC3D-SA7C-I-56P-8-①-②-③-④	8	40	14	
ERC3D-SA7C-I-56P-4-①-②-③-④	4	45	22	

Legend ① Stroke ② I/O type ③ Cable length ④ Option

Stroke and Maximum Speed by Lead

Stroke Lead	Stroke (mm)					
	50~550 (every 50mm)	600 (mm)	650 (mm)	700 (mm)	750 (mm)	800 (mm)
24	1200	1155	1010	890	790	
16	980 <840>	865 <840>	750	655	580	515
8	490	430	375	325	290	255
4	210	185	160	145	125	

The value inside <> indicates vertical usage.

The values of lead 8 and lead 4 apply when acceleration is at 0.1G.

(Unit: mm/s)

① Stroke

Stroke (mm)	Standard price	Stroke (mm)	Standard price
50	—	450	—
100	—	500	—
150	—	550	—
200	—	600	—
250	—	650	—
300	—	700	—
350	—	750	—
400	—	800	—

③ Cable length

Type	Cable symbol	Standard price	
		PIO type	SIO type
Standard type (Robot cable)	P (1m)	—	—
	S (3m)	—	—
	M (5m)	—	—
Special length	X06(6m)~X10(10m)	—	—

*Refer to P.44 for maintenance cables.

④ Options

Name	Option code	See page	Standard price
Brake	B	→P12	—
Non-motor end specification	NM	→P12	—
Simple absolute specification	ABU	→P12	— (*)

(*) If the simple absolute specification is selected, the separately sold PIO converter of simple absolute specification (with battery) is required.

Dimensional Drawings

CAD drawings can be downloaded from the website.

www.intelligentactuator.com

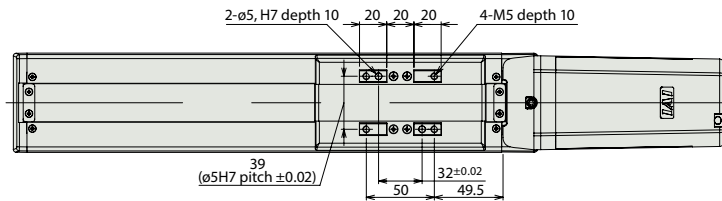

*1 Connect the power & I/O cable. Refer to P.44 for details on this cable SE: Stroke End ME: Mechanical End

*2 The slider moves to the ME during home return, so pay attention to possible contact with surrounding structures.

*3 Reference position is used when calculating the Ma and Mc moments

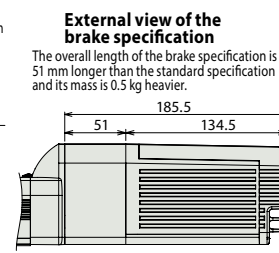
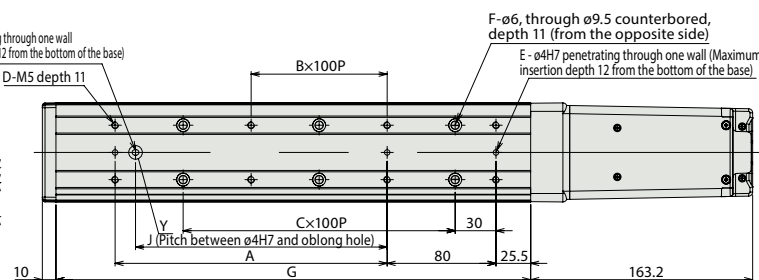
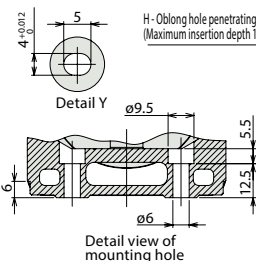
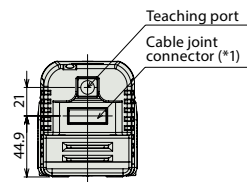
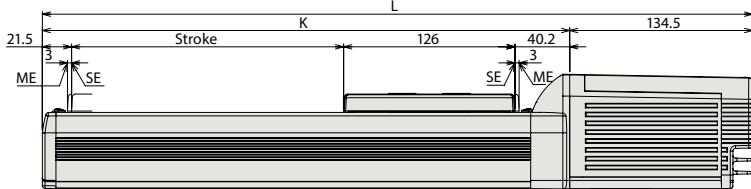
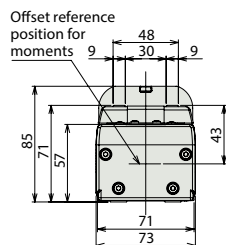

Actuator specification

Item	Description
Drive system	Ball screw ø12 mm, rolled C10
Positioning repeatability (*1)	± 0.02 mm [± 0.03 mm]
Lost motion	0.1 mm or less
Static allowable load moment	Ma: 70.0 N·m, Mb: 100.0 N·m, Mc: 159.5 N·m
Dynamic allowable load moment (*2)	Ma: 15.0 N·m, Mb: 21.4 N·m, Mc: 34.1 N·m
Overhang load lengths	150 mm or less in Ma direction, 150 mm or less in Mb and Mc directions
Ambient operation temperature, humidity	0 to 40°C, 85% RH or less (Non-condensing)

(*1) The specification in [] applies when the lead is 24 mm.

(*2) Based on 5,000 km of traveling life.

Allowable load moment directions

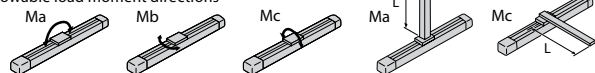

Dimensions and Mass by Stroke

Stroke	50	100	150	200	250	300	350	400	450	500	550	600	650	700	750	800
L	372.2	422.2	472.2	522.2	572.2	622.2	672.2	722.2	772.2	822.2	872.2	922.2	972.2	1022.2	1072.2	1122.2
A	0	100	100	200	200	300	300	400	400	500	500	600	600	700	700	800
B	0	0	0	1	1	2	2	3	3	4	4	5	5	6	6	7
C	1	1	2	2	3	3	4	4	5	5	6	6	7	7	8	8
D	4	6	6	8	8	10	10	12	12	14	14	16	16	18	18	20
E	2	3	3	3	3	3	3	3	3	3	3	3	3	3	3	3
F	4	4	6	6	8	8	10	10	12	12	14	14	16	16	18	18
G	199	249	299	349	399	449	499	549	599	649	699	749	799	849	899	949
H	0	1	1	1	1	1	1	1	1	1	1	1	1	1	1	1
J	0	85	85	185	185	285	285	385	385	485	485	585	585	685	685	785
K	237.7	287.7	337.7	387.7	437.7	487.7	537.7	587.7	637.7	687.7	737.7	787.7	837.7	887.7	937.7	987.7
Mass (kg)	3.6	3.9	4.1	4.4	4.7	4.9	5.2	5.5	5.7	6.0	6.3	6.5	6.8	7.1	7.3	7.6

Controllers (Built into the Actuator)

@I/O type

With the ERC3 series, one of the following five types of built-in controllers can be selected depending on the external input/output (I/O) type. Select the type that meets your purpose.

Name	External view	Model number	Features	Maximum number of positioning points	Input power	Power supply capacity	Standard price	Reference page
PIO type (NPN specification)		ERC3D-SA7C-I-56P-□-□-NP-□-□	Simple control type accommodating up to 16 positioning points	16	DC24V	High-output setting enabled: 3.5A rated 4.2A max. High-output setting disabled: 2.2A	—	→P35
PIO type (PNP specification)		ERC3D-SA7C-I-56P-□-□-PN-□-□	I/O type supporting inputs/outputs of the PNP specification often used overseas	16				
SIO type		ERC3D-SA7C-I-56P-□-□-SE-□-□	High-function type accommodating up to 512 positioning points (PIO converter is used)	512				
Pulse-train type (NPN specification)		ERC3D-SA7C-I-56P-□-□-PLN-□-□	Pulse-train input type supporting the NPN specification	—				
Pulse-train type (PNP specification)		ERC3D-SA7C-I-56P-□-□-PLP-□-□	Pulse-train input type supporting the PNP specification	—				

ERC3-SA5C

- Standard type
- Slider type
- Actuator Width 50mm

Model Specification Items	ERC3	SA5C	I	42P						
	Series	Type	Encoder type	Motor type	Lead	Stroke	I/O type	Cable length	Controller type	Option
			I: Incremental specification	42□ Pulse motor	20: 20mm 12: 12mm 6: 6mm 3: 3mm	50: 50mm ? 800: 800mm (Can be set in 50mm increments)	NP: PIO (NPN) type PN: PIO (PNP) type SE: SIO type PLN: Pulse-train (NPN) type PLP: Pulse-train (PNP) type	N: None P: 1m S: 3m M: 5m X□□: Specified length	CN: CON type MC: MEC type	B : Brake NM : Non-motor end specification ABU: Simple absolute specification

*Refer to P.11 for the description of items constituting the model number.

RoHS

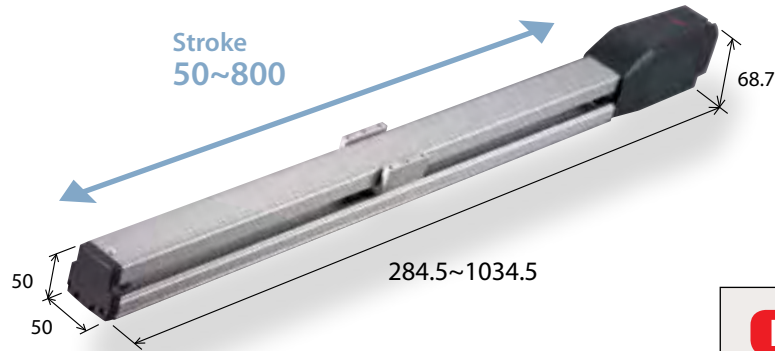

POINT Notes on selection

If the high-output setting is enabled (factory default), the duty must be limited. (Refer to P.13.) If the high-output setting is disabled, the payload and maximum speed become lower, but the actuator can be used at a duty of 100%. Refer to the operation manual for information on how to change the high-output setting. Refer to P.32 for the payload at each speed/acceleration when the high-output setting is enabled. Refer to P.33 for the specifications that apply when the high-output setting is disabled.

For other cautionary items, refer to "Explanations of/Cautionary Notes on Items Specified in Catalog (P.13)."

Correlation diagrams of Speed and Payload

With the ERC3 series, due to the characteristics of the pulse motor, payload decreases as the speed increases. Use the chart below to confirm that the desired speed and payload requirements are met.

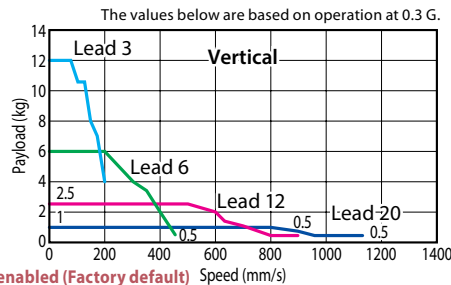
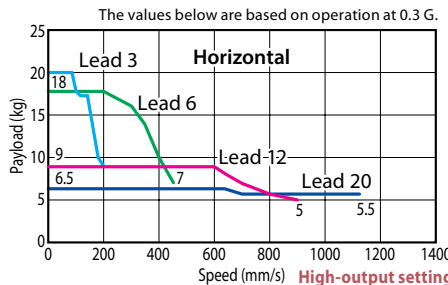

Actuator Specifications (High-output Setting Enabled)

Leads and Payloads

(Note 1) Take caution that the maximum payload decreases as the speed increases.

Model number	Lead (mm)	Maximum payload (Note 1)		Stroke (mm)
		Horizontal (kg)	Vertical (kg)	
ERC3-SA5C-I-42P-20-①-②-③-④	20	6.5	1	50~800 (every 50mm)
ERC3-SA5C-I-42P-12-①-②-③-④	12	9	2.5	
ERC3-SA5C-I-42P-6-①-②-③-④	6	18	6	
ERC3-SA5C-I-42P-3-①-②-③-④	3	20	12	

Legend ① Stroke ② I/O type ③ Cable length ④ Option

Stroke and Maximum Speed by Lead

Stroke / Lead	Maximum Speed (mm/s)							
	50~450 (every 50mm)	500 (mm)	550 (mm)	600 (mm)	650 (mm)	700 (mm)	750 (mm)	800 (mm)
20	1120	1115	935	795	680	585	510	
12	900	805	665	560	475	405	350	300
6	450	400	330	280	235	200	175	150
3	225	200	165	140	115	100	85	75

The values of lead 3 apply when acceleration is at 0.1G.

(Unit: mm/s)

① Stroke

Stroke (mm)	Standard price	Stroke (mm)	Standard price
50	—	450	—
100	—	500	—
150	—	550	—
200	—	600	—
250	—	650	—
300	—	700	—
350	—	750	—
400	—	800	—

③ Cable length

Type	Cable symbol	Standard price	
		PIO type	SIO type
Standard type (Robot cable)	P (1m)	—	—
	S (3m)	—	—
	M (5m)	—	—
Special length	X06(6m)~X10(10m)	—	—

*Refer to P. 44 for maintenance cables.

④ Options

Name	Option code	See page	Standard price
Brake	B	→P12	—
Non-motor end specification	NM	→P12	—
Simple absolute specification	ABU	→P12	— (*)

(*) If the simple absolute specification is selected, the separately sold PIO converter of simple absolute specification (with battery) is required.

Dimensional Drawings

CAD drawings can be downloaded from the website.

www.intelligentactuator.com

2D CAD

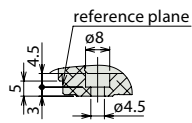

Detail view of X (Mounting hole and the reference plane)

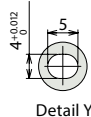
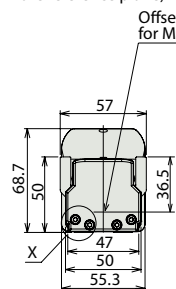

Detail Y

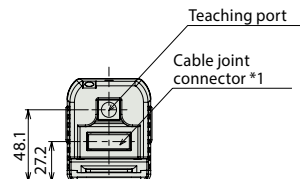
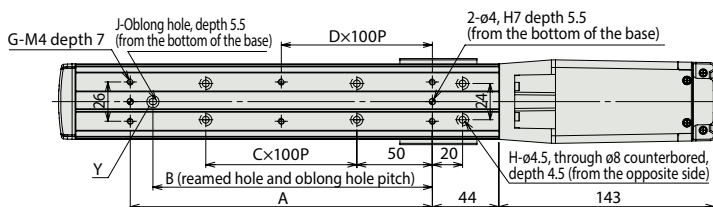
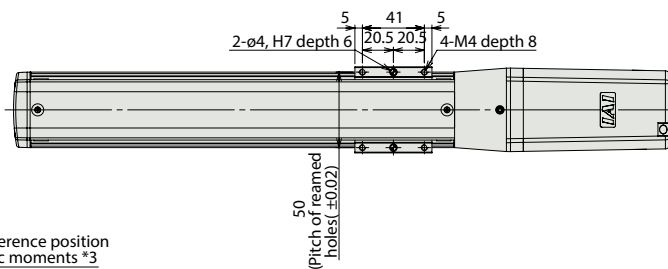

*1 Connect the power & I/O cable. Refer to P.44 for details on this cable
SE: Stroke End
ME: Mechanical End

*2 The slider moves to the ME during home return, so pay attention to possible contact with surrounding structures.

*3 Reference position is used when calculating the Ma and Mc moments

External view of the brake specification

The overall length of the brake specification is 42.5 mm longer than the standard specification and its mass is 0.4 kg heavier.

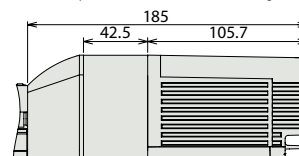

Actuator specification

Item	Description
Drive system	Ball screw ø10 mm, rolled C10
Positioning repeatability (*1)	± 0.02 mm [± 0.03 mm]
Lost motion	0.1 mm or less
Static allowable load moment	Ma: 29.4 N·m, Mb: 42.0 N·m, Mc: 60.5 N·m
Dynamic allowable load moment (*2)	Ma: 7.1 N·m, Mb: 10.2 N·m, Mc: 14.7 N·m
Overhang load lengths	150 mm or less in Ma direction, 150 mm or less in Mb and Mc directions
Ambient operation temperature, humidity	0 to 40°C, 85% RH or less (Non-condensing)

(*1) The specification in [] applies when the lead is 20 mm.

(*2) Based on 5,000 km of traveling life.

Allowable load moment directions

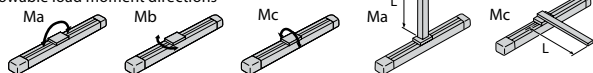

Dimensions and Mass by Stroke

Stroke	50	100	150	200	250	300	350	400	450	500	550	600	650	700	750	800
L	284.5	334.5	384.5	434.5	484.5	534.5	584.5	634.5	684.5	734.5	784.5	834.5	884.5	934.5	984.5	1034.5
A	73	100	100	200	200	300	300	400	400	500	500	600	600	700	700	800
B	0	85	85	185	185	285	285	385	385	485	485	585	585	685	685	785
C	0	0	1	1	2	2	3	3	4	4	5	5	6	6	7	7
D	0	0	0	1	1	2	2	3	3	4	4	5	5	6	6	7
F	142	192	242	292	342	392	442	492	542	592	642	692	742	792	842	892
G	4	4	4	6	6	8	8	10	10	12	12	14	14	16	16	18
H	4	4	6	6	8	8	10	10	12	12	14	14	16	16	18	18
J	0	1	1	1	1	1	1	1	1	1	1	1	1	1	1	1
Mass (kg)	1.4	1.5	1.6	1.7	1.9	2.0	2.1	2.2	2.3	2.4	2.5	2.7	2.8	2.9	3.0	3.1

Controllers (Built into the Actuator)

@I/O type

With the ERC3 series, one of the following five types of built-in controllers can be selected depending on the external input/output (I/O) type. Select the type that meets your purpose.

Name	External view	Model number	Features	Maximum number of positioning points	Input power	Power supply capacity	Standard price	Reference page
PIO type (NPN specification)		ERC3-SA5C-I-42P-□-□-NP-□-□	Simple control type accommodating up to 16 positioning points	16	DC24V	High-output setting enabled: 3.5A rated 4.2A max. High-output setting disabled: 2.2A	—	→P35
PIO type (PNP specification)		ERC3-SA5C-I-42P-□-□-PN-□-□	I/O type supporting inputs/outputs of the PNP specification often used overseas	16				
SIO type		ERC3-SA5C-I-42P-□-□-SE-□-□	High-function type accommodating up to 512 positioning points (PIO converter is used)	512				
Pulse-train type (NPN specification)		ERC3-SA5C-I-42P-□-□-PLN-□-□	Pulse-train input type supporting the NPN specification	—				
Pulse-train type (PNP specification)		ERC3-SA5C-I-42P-□-□-PLP-□-□	Pulse-train input type supporting the PNP specification	—				

ERC3-SA7C

- Standard type
- Slider type
- Actuator Width 74mm

Model Specification Items	ERC3	SA7C	I	56P						
	Series	Type	Encoder type	Motor type	Lead	Stroke	I/O type	Cable length	Controller type	Option
			I: Incremental specification	56□ Pulse motor	24: 24mm 16: 12mm 8: 8mm 4: 4mm	50:50mm ? 800:800mm (Can be set in 50mm increments)	NP: PIO (NPN) type PN: PIO (PNP) type SE: SIO type PLN: Pulse-train (NPN) type PLP: Pulse-train (PNP) type	N: None P: 1m S: 3m M: 5m X□□: Specified length	CN: CON type MC: MEC type	B : Brake NM : Non-motor end specification ABU: Simple absolute specification

*Refer to P.11 for the description of items constituting the model number.

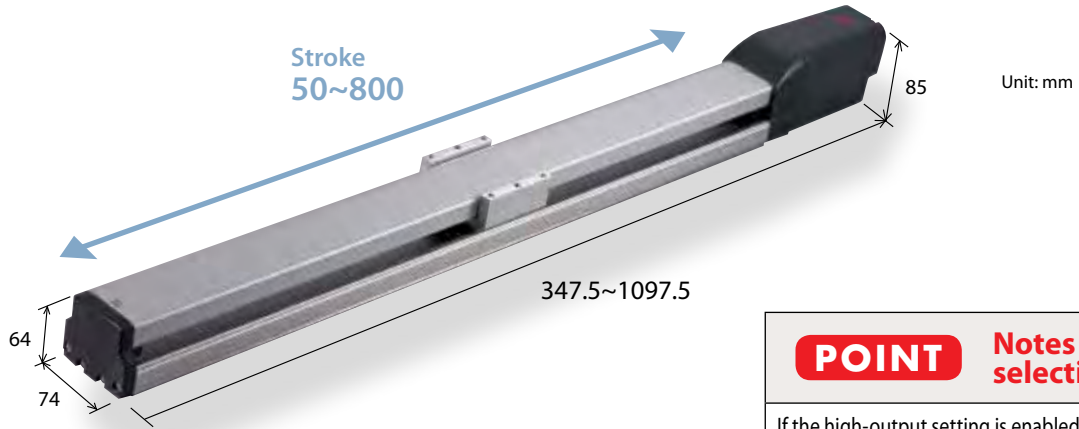

POINT Notes on selection

If the high-output setting is enabled (factory default), the duty must be limited. (Refer to P.13.) If the high-output setting is disabled, the payload and maximum speed become lower, but the actuator can be used at a duty of 100%. Refer to the operation manual for information on how to change the high-output setting. Refer to P.32 for the payload at each speed/acceleration when the high-output setting is enabled. Refer to P.33 for the specifications that apply when the high-output setting is disabled.

For other cautionary items, refer to "Explanations of/Cautionary Notes on Items Specified in Catalog (P.13)."

Correlation diagrams of Speed and Payload

With the ERC3 series, due to the characteristics of the pulse motor, payload decreases as the speed increases. Use the chart below to confirm that the desired speed and payload requirements are met.

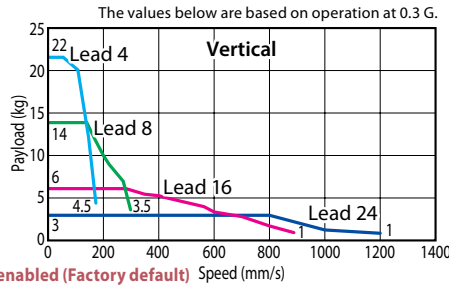
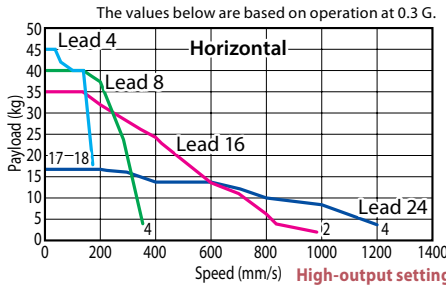

Actuator Specifications (High-output Setting Enabled)

Leads and Payloads

(Note 1) Take caution that the maximum payload decreases as the speed increases.

Model number	Lead (mm)	Maximum payload (Note 1)		Stroke (mm)
		Horizontal (kg)	Vertical (kg)	
ERC3-SA7C-I-56P-24-①-②-③-④	24	17	3	50~800 (every 50mm)
ERC3-SA7C-I-56P-16-①-②-③-④	16	35	6	
ERC3-SA7C-I-56P-8-①-②-③-④	8	40	14	
ERC3-SA7C-I-56P-4-①-②-③-④	4	45	22	

Legend ① Stroke ② I/O type ③ Cable length ④ Option

Stroke and Maximum Speed by Lead

Stroke / Lead	50~550 (every 50mm)	600 (mm)	650 (mm)	700 (mm)	750 (mm)	800 (mm)
24	1200	1130	975	850	745	
16	980 <> 840	880 <> 840	750	645	565	495
8	490	440	375	320	280	245
4	210	185	160	140	140	120

The value inside <> indicates vertical usage.

The values of lead 8 and lead 4 apply when acceleration is at 0.1G.

(Unit: mm/s)

① Stroke

Stroke (mm)	Standard price	Stroke (mm)	Standard price
50	—	450	—
100	—	500	—
150	—	550	—
200	—	600	—
250	—	650	—
300	—	700	—
350	—	750	—
400	—	800	—

③ Cable length

Type	Cable symbol	Standard price	
		PIO type	SIO type
Standard type (Robot cable)	P (1m)	—	—
	S (3m)	—	—
	M (5m)	—	—
Special length	X06(6m)~X10(10m)	—	—

*Refer to P. 44 for maintenance cables.

④ Options

Name	Option code	See page	Standard price
Brake	B	→P12	—
Non-motor end specification	NM	→P12	—
Simple absolute specification	ABU	→P12	— (*)

(*) If the simple absolute specification is selected, the separately sold PIO converter of simple absolute specification (with battery) is required.

Dimensional Drawings

CAD drawings can be downloaded from the website. www.intelligentactuator.com

2D CAD

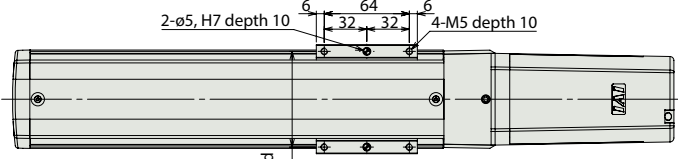
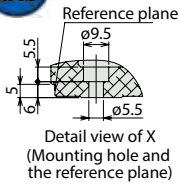

*1 Connect the power & I/O cable. Refer to P.44 for details on this cable
SE: Stroke End
ME: Mechanical End

*2 The slider moves to the ME during home return, so pay attention to possible contact with surrounding structures.

*3 Reference position is used when calculating the Ma and Mc moments

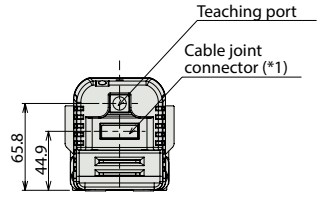
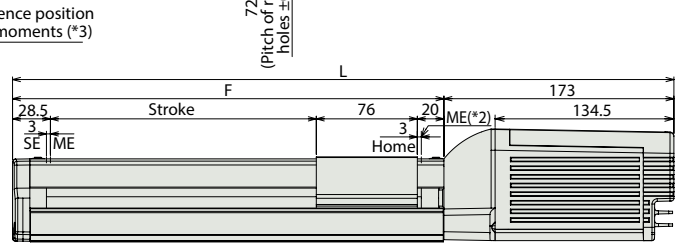
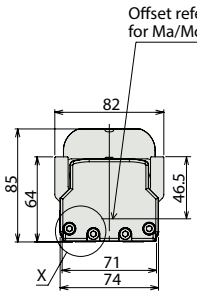

External view of the brake specification
The overall length of the brake specification is 51 mm longer than the standard specification and its mass is 0.5 kg heavier.

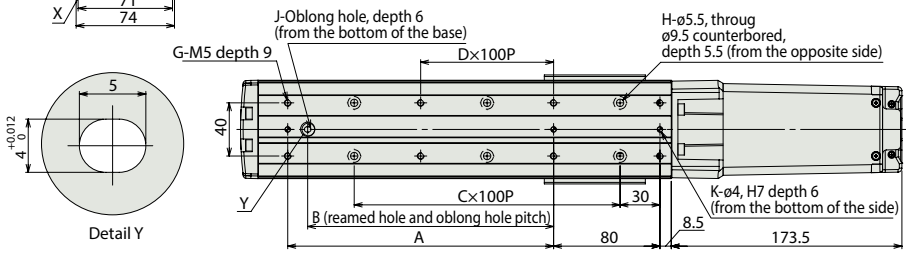
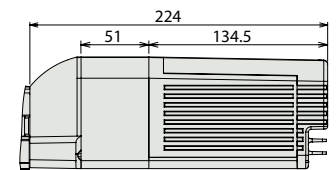

Actuator specification

Item	Description
Drive system	Ball screw ø12 mm, rolled C10
Positioning repeatability (*1)	± 0.02 mm [± 0.03 mm]
Lost motion	0.1 mm or less
Static allowable load moment	Ma: 70.0 N·m, Mb: 100.0 N·m, Mc: 159.5 N·m
Dynamic allowable load moment (*2)	Ma: 15.0 N·m, Mb: 21.4 N·m, Mc: 34.1 N·m
Overhang load lengths	150 mm or less in Ma direction, 150 mm or less in Mb and Mc directions
Ambient operation temperature, humidity	0 to 40°C, 85% RH or less (Non-condensing)

(*1) The specification in [] applies when the lead is 24 mm.
(*2) Based on 5,000 km of traveling life.

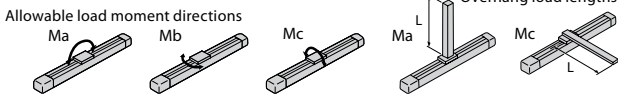

Dimensions and Mass by Stroke

Stroke	50	100	150	200	250	300	350	400	450	500	550	600	650	700	750	800
L	347.5	397.5	447.5	497.5	547.5	597.5	647.5	697.5	747.5	797.5	847.5	897.5	947.5	997.5	1047.5	1097.5
A	0	100	100	200	200	300	300	400	400	500	500	600	600	700	700	800
B	0	85	85	185	185	285	285	385	385	485	485	585	585	685	685	785
C	1	1	2	2	3	3	4	4	5	5	6	6	7	7	8	8
D	0	0	0	1	1	2	2	3	3	4	4	5	5	6	6	7
F	174.5	224.5	274.5	324.5	374.5	424.5	474.5	524.5	574.5	624.5	674.5	724.5	774.5	824.5	874.5	924.5
G	4	6	6	8	8	10	10	12	12	14	14	16	16	18	18	20
H	4	4	6	6	8	8	10	10	12	12	14	14	16	16	18	18
J	0	1	1	1	1	1	1	1	1	1	1	1	1	1	1	1
K	2	3	3	3	3	3	3	3	3	3	3	3	3	3	3	3
Mass (kg)	3.2	3.4	3.6	3.8	4.0	4.3	4.5	4.7	4.9	5.1	5.4	5.6	5.8	6.0	6.2	6.5

Controllers (Built into the Actuator)

@I/O type

With the ERC3 series, one of the following five types of built-in controllers can be selected depending on the external input/output (I/O) type. Select the type that meets your purpose.

Name	External view	Model number	Features	Maximum number of positioning points	Input power	Power supply capacity	Standard price	Reference page
PIO type (NPN specification)		ERC3-SA7C-I-56P-□-□-NP-□-□	Simple control type accommodating up to 16 positioning points	16	DC24V	High-output setting enabled: 3.5A rated 4.2A max. High-output setting disabled: 2.2A	—	→P35
PIO type (PNP specification)		ERC3-SA7C-I-56P-□-□-PN-□-□	I/O type supporting inputs/outputs of the PNP specification often used overseas	16				
SIO type		ERC3-SA7C-I-56P-□-□-SE-□-□	High-function type accommodating up to 512 positioning points (PIO converter is used)	512				
Pulse-train type (NPN specification)		ERC3-SA7C-I-56P-□-□-PLN-□-□	Pulse-train input type supporting the NPN specification	—				
Pulse-train type (PNP specification)		ERC3-SA7C-I-56P-□-□-PLP-□-□	Pulse-train input type supporting the PNP specification	—				

ERC3-RA4C

- Standard type
- Rod type ● Actuator Width 45mm

Model Specification Items	ERC3	RA4C	I	42P						
	Series	Type	Encoder type	Motor type	Lead	Stroke	I/O type	Cable length	Controller type	Option
			I: Incremental specification	42□ Pulse motor	20: 20mm 12: 12mm 6: 6mm 3: 3mm	50: 50mm ? 300: 300mm (Can be set in 50mm increments)	NP: PIO (NPN) type PN: PIO (PNP) type SE: SIO type PLN: Pulse-train (NPN) type PLP: Pulse-train (PNP) type	N: None P: 1m S: 3 m M: 5m X□□: Specified length	CN: CON type MC: MEC type	B : Brake NM : Non-motor end specification ABU: Simple absolute specification FL : Flange FT : Foot bracket

*Refer to P.11 for the description of items constituting the model number.

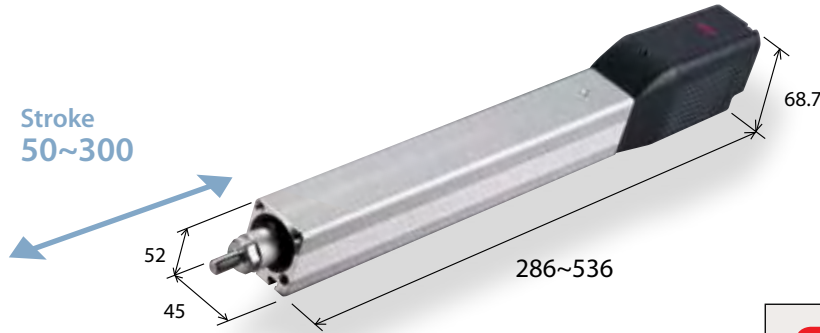

Unit: mm

POINT Notes on selection

If the high-output setting is enabled (factory default), the duty must be limited. (Refer to P.13.) If the high-output setting is disabled, the payload and maximum speed become lower, but the actuator can be used at a duty of 100%. Refer to the operation manual for information on how to change the high-output setting. Refer to P.32 for the payload at each speed/acceleration when the high-output setting is enabled. Refer to P.33 for the specifications that apply when the high-output setting is disabled.

For other cautionary items, refer to "Explanations of/Cautionary Notes on Items Specified in Catalog (P.13)."

Correlation diagrams of Speed and Payload

With the ERC3 series, due to the characteristics of the pulse motor, payload decreases as the speed increases. Use the chart below to confirm that the desired speed and payload requirements are met.

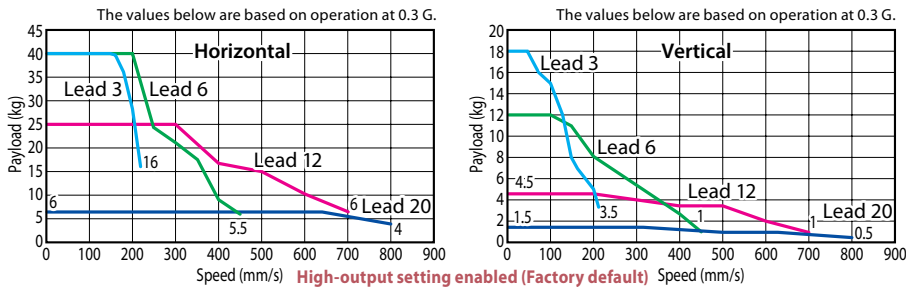

Actuator Specifications (High-output Setting Enabled)

Leads and Payloads

(Note 1) Take caution that the maximum payload decreases as the speed increases.

Model number	Lead (mm)	Maximum payload (Note 1)		Maximum push force (N)	Stroke (mm)
		Horizontal (kg)	Vertical (kg)		
ERC3-RA4C-I-42P-20-①-②-③-④	20	6	1.5	56	50~300 (every 50mm)
ERC3-RA4C-I-42P-12-①-②-③-④	12	25	4.5	93	
ERC3-RA4C-I-42P-6-①-②-③-④	6	40	12	185	
ERC3-RA4C-I-42P-3-①-②-③-④	3	40	18	370	

Legend ① Stroke ② I/O type ③ Cable length ④ Option

Stroke and Maximum Speed

(Unit: mm/s)

Stroke / Lead	50~200 (every 50mm)	250 (mm)	300 (mm)
20	800		
12	700	695	485
6	450	345	240
3	225	170	120

The values of lead 3 apply when acceleration is at 0.1G.

① Stroke

Stroke (mm)	Standard price
50	—
100	—
150	—
200	—
250	—
300	—

③ Cable length

Type	Cable symbol	Standard price	
		PIO type	SIO type
Standard type (Robot cable)	P (1m)	—	—
	S (3m)	—	—
	M (5m)	—	—
Special length	X06(6m)~X10(10m)	—	—

*Refer to P. 44 for maintenance cables.

④ Options

Name	Option code	See page	Standard price
Brake	B	→P12	—
Non-motor end specification	NM	→P12	—
Simple absolute specification	ABU	→P12	— (*)
Flange	FL	→P12	—
Foot bracket	FT	→P12	—

(*) If the simple absolute specification is selected, the separately sold PIO converter of simple absolute specification (with battery) is required.

Dimensional Drawings

CAD drawings can be downloaded from the website. www.intelligentactuator.com

2D CAD

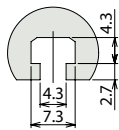

Detail A

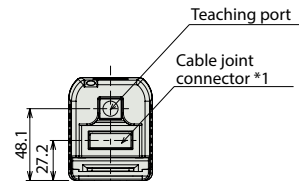
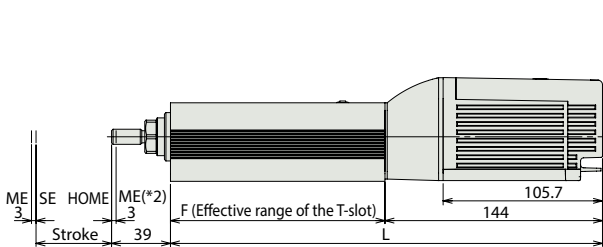
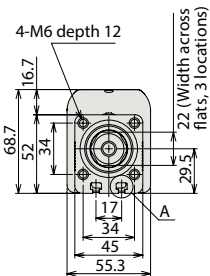
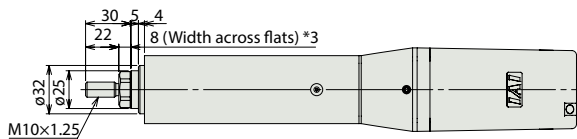

External view of the brake specification

The overall length of the brake specification is 42.5 mm longer than the standard specification and its mass is 0.4 kg heavier.

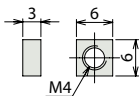

Supplied square nut for mounting via the T-slot (4 pcs are supplied)

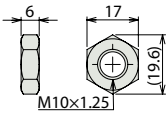

Supplied rod end nut

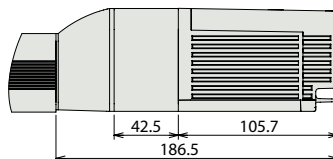

*1 Connect the power & I/O cable. Refer to P.44 for details on this cable
SE: Stroke End
ME: Mechanical End

*2 The rod moves to the ME during home return, so pay attention to possible contact with surrounding structures.

*3 The orientation of the bolt will vary depending on the product.

Actuator specification

Item	Description
Drive system	Ball screw ø10 mm, rolled C10
Positioning repeatability (*1)	± 0.02 mm [± 0.03 mm]
Lost motion	0.1 mm or less [0.2 mm or less]
Rod diameter	ø25 mm
Rod non-rotation precision	±1.5 degrees
Ambient operating temperature, humidity	0 to 40°C, 85% RH or less (Non-condensing)

(*1) The specification in [] applies when the lead is 20 mm.

Dimensions and Mass by Stroke

Stroke	50	100	150	200	250	300
L	286	336	386	436	486	536
F	142	192	242	292	342	392
Mass (kg)	1.4	1.7	2.0	2.3	2.6	2.9

Controllers (Built into the Actuator)

@I/O type

With the ERC3 series, one of the following five types of built-in controllers can be selected depending on the external input/output (I/O) type. Select the type that meets your purpose.

Name	External view	Model number	Features	Maximum number of positioning points	Input power	Power supply capacity	Standard price	Reference page
PIO type (NPN specification)		ERC3-RA4C-I-42P-□-□-NP-□-□	Simple control type accommodating up to 16 positioning points	16	DC24V	High-output setting enabled: 3.5A rated 4.2A max. High-output setting disabled: 2.2A	—	→P35
PIO type (PNP specification)		ERC3-RA4C-I-42P-□-□-PN-□-□	I/O type supporting inputs/outputs of the PNP specification often used overseas	16				
SIO type		ERC3-RA4C-I-42P-□-□-SE-□-□	High-function type accommodating up to 512 positioning points (PIO converter is used)	512				
Pulse-train type (NPN specification)		ERC3-RA4C-I-42P-□-□-PLN-□-□	Pulse-train input type supporting the NPN specification	—				
Pulse-train type (PNP specification)		ERC3-RA4C-I-42P-□-□-PLP-□-□	Pulse-train input type supporting the PNP specification	—				

ERC3-RA6C

- Standard type
- Rod type ● Actuator Width 64mm

Model Specification Items	ERC3	RA6C	I	56P						
	Series	Type	Encoder type	Motor type	Lead	Stroke	I/O type	Cable length	Controller type	Option
			I: Incremental specification	56□ Pulse motor	24: 24mm 16: 16mm 8: 8mm 4: 4mm	50: 50mm ? 300: 300mm (Can be set in 50mm increments)	NP: PIO (NPN) type PN: PIO (PNP) type SE: SIO type PLN: Pulse-train (NPN) type PLP: Pulse-train (PNP) type	N: None P: 1m S: 3m M: 5m X□□: Specified length	CN: CON type MC: MEC type	B : Brake NM : Non-motor end specification ABU: Simple absolute specification FL : Flange FT : Foot bracket

*Refer to P.11 for the description of items constituting the model number.

RoHS

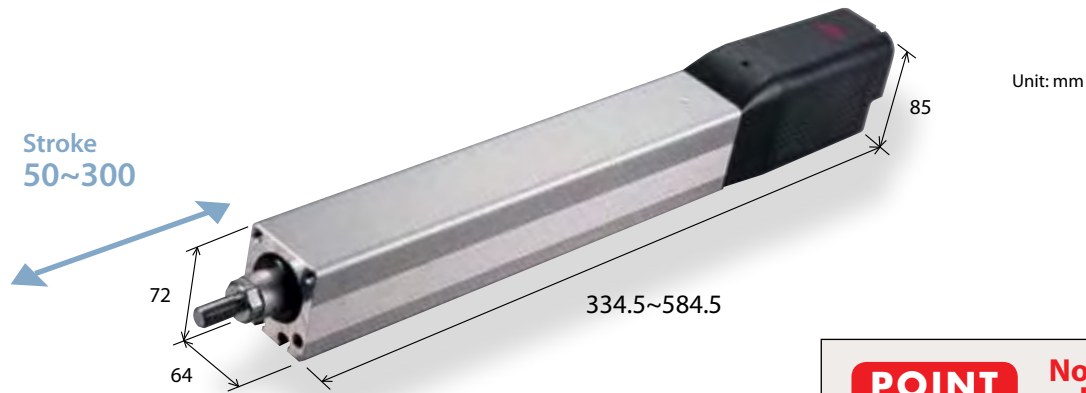

POINT Notes on selection

If the high-output setting is enabled (factory default), the duty must be limited. (Refer to P.13.) If the high-output setting is disabled, the payload and maximum speed become lower, but the actuator can be used at a duty of 100%. Refer to the operation manual for information on how to change the high-output setting. Refer to P.32 for the payload at each speed/acceleration when the high-output setting is enabled. Refer to P.33 for the specifications that apply when the high-output setting is disabled.

For other cautionary items, refer to "Explanations of/Cautionary Notes on Items Specified in Catalog (P.13)."

Correlation diagrams of Speed and Payload

With the ERC3 series, due to the characteristics of the pulse motor, payload decreases as the speed increases. Use the chart below to confirm that the desired speed and payload requirements are met.

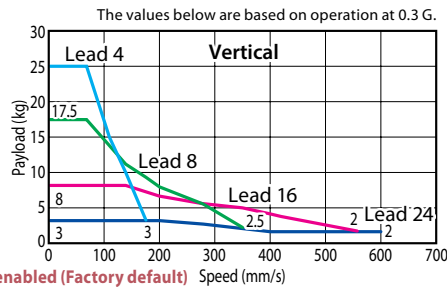
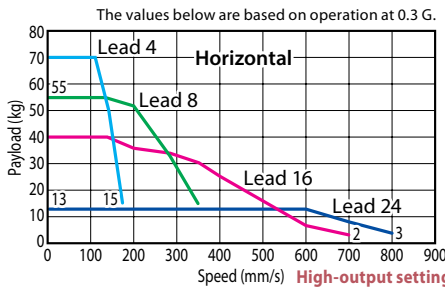

Actuator Specifications (High-output Setting Enabled)

Leads and Payloads

(Note 1) Take caution that the maximum payload decreases as the speed increases.

Model number	Lead (mm)	Maximum payload (Note 1)		Maximum push force (N)	Stroke (mm)
		Horizontal (kg)	Vertical (kg)		
ERC3-RA6C-I-56P-24-①-②-③-④	24	13	3	182	50~300 (every 50mm)
ERC3-RA6C-I-56P-16-①-②-③-④	16	40	8	273	
ERC3-RA6C-I-56P-8-①-②-③-④	8	55	17.5	547	
ERC3-RA6C-I-56P-4-①-②-③-④	4	70	25	1094	

Legend ① Stroke ② I/O type ③ Cable length ④ Option

Stroke and Maximum Speed

(Unit: mm/s)

Lead	Stroke	Maximum Speed	
		50~250 (every 50mm)	300 (mm)
24	24	800 <600>	
16	16	700 <560>	
8	8	420	400
4	4	210 <175>	210 <175>

The value inside <> indicates vertical usage. The values of lead 8 and lead 4 apply when acceleration is at 0.1G.

① Stroke

Stroke (mm)	Standard price
50	—
100	—
150	—
200	—
250	—
300	—

③ Cable length

Type	Cable symbol	Standard price	
		PIO type	SIO type
Standard type (Robot cable)	P (1m)	—	—
	S (3m)	—	—
	M (5m)	—	—
Special length	X06(6m)~X10(10m)	—	—

*Refer to P.44 for maintenance cables.

④ Options

Name	Option code	See page	Standard price
Brake	B	→P12	—
Non-motor end specification	NM	→P12	—
Simple absolute specification	ABU	→P12	— (*)
Flange	FL	→P12	—
Foot bracket	FT	→P12	—

(*) If the simple absolute specification is selected, the separately sold PIO converter of simple absolute specification (with battery) is required.

Dimensional Drawings

CAD drawings can be downloaded from the website. www.intelligentactuator.com

2D CAD

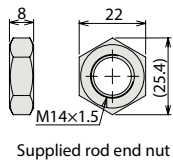
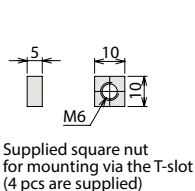
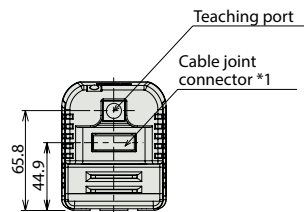
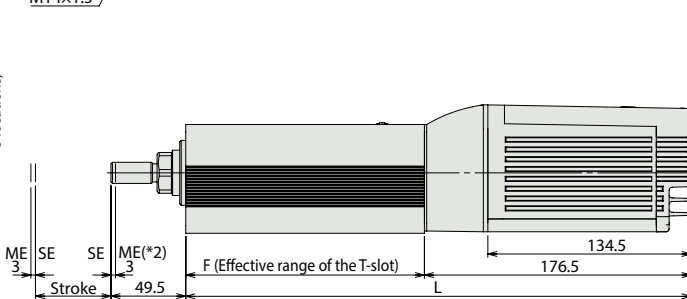
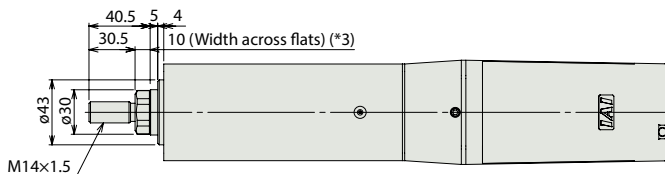
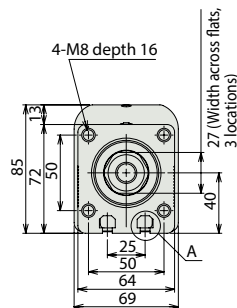
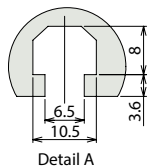

External view of the brake specification

The overall length of the brake specification is 51 mm longer than the standard specification and its mass is 0.5 kg heavier.

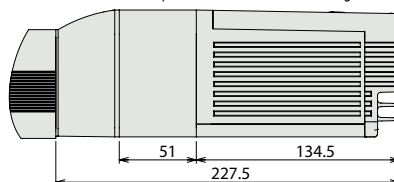

- *1 Connect the power & I/O cable. Refer to P.44 for details on this cable
SE: Stroke End
ME: Mechanical End
- *2 The rod moves to the ME during home return, so pay attention to possible contact with surrounding structures.
- *3 The orientation of the bolt will vary depending on the product.

Actuator specification

Item	Description
Drive system	Ball screw ø12 mm, rolled C10
Positioning repeatability (*1)	± 0.02 mm [± 0.03 mm]
Lost motion	0.1 mm or less [0.2 mm or less]
Rod diameter	ø30 mm
Rod non-rotation precision	± 1.0 degrees
Ambient operating temperature, humidity	0 to 40°C, 85% RH or less (Non-condensing)

(*1) The specification in [] applies when the lead is 24 mm.

Dimensions and Mass by Stroke

Stroke	50	100	150	200	250	300
L	334.5	384.5	434.5	484.5	534.5	584.5
F	158	208	258	308	358	408
Mass (kg)	3.9	4.4	4.9	5.4	5.9	6.4

Controllers (Built into the Actuator)

@I/O type

With the ERC3 series, one of the following five types of built-in controllers can be selected depending on the external input/output (I/O) type. Select the type that meets your purpose.

Name	External view	Model number	Features	Maximum number of positioning points	Input power	Power supply capacity	Standard price	Reference page
PIO type (NPN specification)		ERC3-RA6C-I-56P-□-□-NP-□-□	Simple control type accommodating up to 16 positioning points	16	DC24V	High-output setting enabled: 3.5A rated 4.2A max. High-output setting disabled: 2.2A	—	→P35
PIO type (PNP specification)		ERC3-RA6C-I-56P-□-□-PN-□-□	I/O type supporting inputs/outputs of the PNP specification often used overseas	16				
SIO type		ERC3-RA6C-I-56P-□-□-SE-□-□	High-function type accommodating up to 512 positioning points (PIO converter is used)	512				
Pulse-train type (NPN specification)		ERC3-RA6C-I-56P-□-□-PLN-□-□	Pulse-train input type supporting the NPN specification	—				
Pulse-train type (PNP specification)		ERC3-RA6C-I-56P-□-□-PLP-□-□	Pulse-train input type supporting the PNP specification	—				

Selection Guideline (Correlation Diagram of the Push Force and the Current-limiting Value)

In a push-motion operation, the push force can be used by changing the current-limiting value of the controller over a range of 20% to 70%. The maximum push-force varies depending on the model, so check the required push force from the table below and select an appropriate type meeting the purpose of use.

When performing a push-motion operation using a slider actuator, limit the push current so that the reactive force moment generated by the push force will not exceed 80% of the rated moment (M_a , M_b) specified in the catalog.

To help with the moment calculations, the application position of the guide moment is shown in the figure below. Calculate the necessary moment by considering the offset of the push force application position.

Note that if an excessive force exceeding the rated moment is applied, the guide may be damaged and the life may become shorter. Accordingly, include a sufficient safety factor when deciding on the push force.

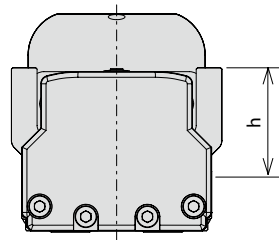

ERC3	SA5C : h=36.5mm
	SA7C : h=46.5mm
ERC3CR/ERC3D	SA5C : h=39mm
	SA7C : h=43mm

Calculation example)

If a push-motion operation is performed with an ERC3-SA7C by applying 100 N at the position shown to the right, the moment received by the guide, or M_a , is calculated as $(46.5 + 50) \times 100$
 $= 9650 \text{ (N}\cdot\text{mm)}$
 $= 9.65 \text{ (N}\cdot\text{m)}$.

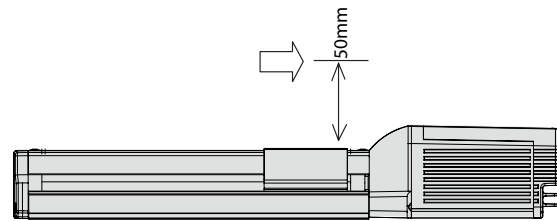

Since the rated moment M_a of the SA7C is 15 (N·m), $15 \times 0.8 = 12 > 9.65$, suggesting that this selection is acceptable. If an M_b moment generates due to the push-motion operation, calculate the moment from the overhang length and confirm, in the same way, that the calculated moment is within 80% of the rated moment.

Correlation Diagrams of the Push Force and the Current-limiting Value

The table below is only a reference, and the graphs may vary slightly from the actual values.

SA5C/RA4C type

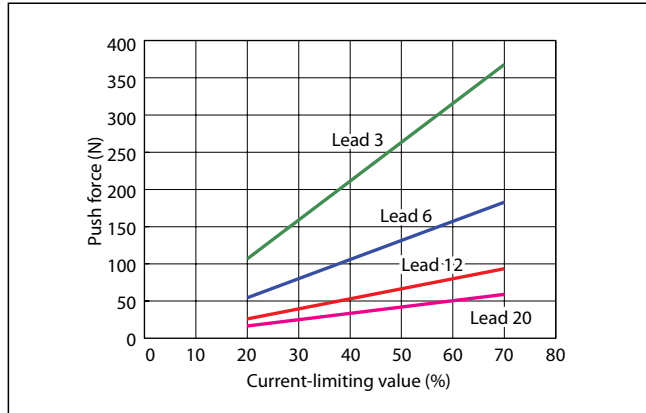

SA7C type

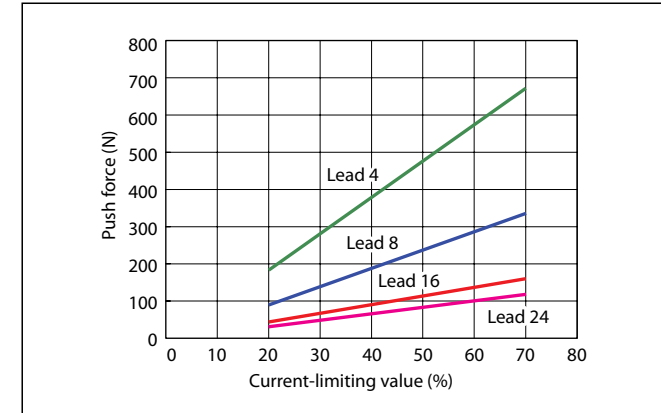

RA6C type

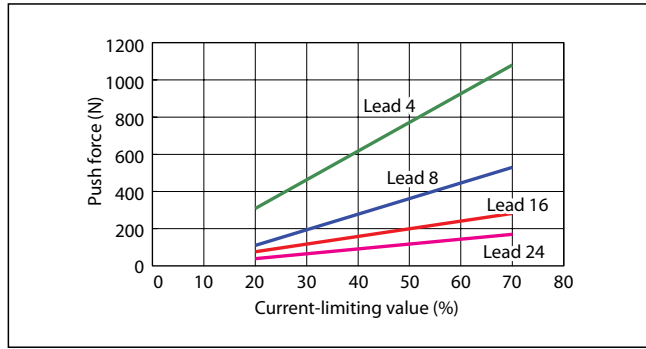

Notes on Use

- The relationship of the push force and the current-limiting value is only a reference, and the graphs may vary slightly from the actual values.
- If the current-limiting value is less than 20%, the push force may vary. Make sure the current-limiting value remains 20% or more.
- The graphs assume a traveling speed of 20 mm/s during push-motion operation.

Selection Guideline

(Table of ERC3 Payload by Speed/Acceleration)

High-output setting enabled
(Factory default)

The maximum acceleration/deceleration of the ERC3 is 1.0 G in a horizontal application or 0.5 G in vertical application. The payload drops as the acceleration increases, so when selecting a model, use the tables below to find one that meets the desired speed, acceleration and payload.

ERC3-SA5C

Lead 20

Orientation	Horizontal			Vertical				
	Acceleration (G)							
Speed (mm/s)	0.1	0.3	0.5	0.7	1	0.1	0.3	0.5
0	6.5	6.5	5	5	4	1	1	1
160	6.5	6.5	5	5	4	1	1	1
320	6.5	6.5	5	5	4	1	1	1
480	6.5	6.5	4	4	4	1	1	1
640	6.5	6.5	3.5	3.5	3	1	1	1
800	5.5	5.5	3.5	3	1	1	1	1
960	5.5	2.5	2	1		0.5	0.5	
1120	5.5	1	1	1		0.5	0.5	

Lead 12

Orientation	Horizontal			Vertical				
	Acceleration (G)							
Speed (mm/s)	0.1	0.3	0.5	0.7	1	0.1	0.3	0.5
0	9	9	9	9	8	2.5	2.5	2.5
100	9	9	9	9	8	2.5	2.5	2.5
200	9	9	9	9	8	2.5	2.5	2.5
300	9	9	9	9	7	2.5	2.5	2.5
400	9	9	8	8	6	2.5	2.5	2.5
500	9	9	8	5.5	5.5	2.5	2.5	2
600	9	9	8	5.5	4	2.5	2	1.5
700	9	7	6	4	2.5	2.5	1	0.5
800	5.5	3.5	2	1		0.5	0.5	
900	5	2.5	1			0.5		

Lead 6

Orientation	Horizontal			Vertical				
	Acceleration (G)							
Speed (mm/s)	0.1	0.3	0.5	0.7	1	0.1	0.3	0.5
0	18	18	13	12	11	6	6	6
50	18	18	13	12	11	6	6	6
100	18	18	13	12	11	6	6	6
150	18	18	13	12	11	6	6	6
200	18	18	13	12	11	6	6	6
250	18	17	13	12	9	6	5	4.5
300	16	16	12	11	7	4.5	4	3.5
350	14	14	8	8	6	4	3.5	3
400	10.5	10	7	4.5	4	2.5	2	1.5
450	7.5	7	4	2.5	1	1	0.5	

Lead 3

Orientation	Horizontal			Vertical				
	Acceleration (G)							
Speed (mm/s)	0.1	0.3	0.5	0.7	1	0.1	0.3	0.5
0	20	20	16	16	13	12	12	12
25	20	20	16	16	13	12	12	12
50	20	20	16	16	12	12	12	12
75	20	20	16	16	12	12	12	12
100	20	18	14	12	10	12	10.5	10.5
125	20	17	14	9.5	8	12	10.5	10.5
150	20	17	11	8	7	9.5	8	8
175	20	10	10	4.5	3.5	7	7	6
200	20	9	3			6	4	2
225	15					4.5		

ERC3-SA7C

Lead 24

Orientation	Horizontal			Vertical				
	Acceleration (G)							
Speed (mm/s)	0.1	0.3	0.5	0.7	1	0.1	0.3	0.5
0	20	17	15	13	11	3	3	3
200	20	17	15	13	11	3	3	3
400	20	14	14	13	10	3	3	3
600	20	14	10	8	8	3	3	3
800	10	10	8	6	2.5	3	2.5	
1000	8	4	2	1		2		
1200	4	2				1		

Lead 16

Orientation	Horizontal			Vertical				
	Acceleration (G)							
Speed (mm/s)	0.1	0.3	0.5	0.7	1	0.1	0.3	0.5
0	35	35	35	26.5	26.5	7	6	4
140	35	35	35	26.5	26.5	7	6	4
280	35	28	28	22	18	7	6	4
420	30	23	12.5	11	10	5	5	4
560	22	15	9.5	7.5	5.5	5	4	3
700	20	11	5.5	3.5	2	3.5	2.5	1.5
840	4	2.5				1		
980	2							

Lead 8

Orientation	Horizontal			Vertical				
	Acceleration (G)							
Speed (mm/s)	0.1	0.3	0.5	0.7	1	0.1	0.3	0.5
0	43	40	40	40	40	15	14	13
70	43	40	40	40	40	15	14	13
140	40	40	40	38	35	15	14	13
210	40	36	35	30	24	11	9	9
280	40	23	11	8	2	8	7	6
350	35	4	2	2		5	3.5	1.5
420	25					2.5		
490	15					1.5		

Lead 4

Orientation	Horizontal			Vertical				
	Acceleration (G)							
Speed (mm/s)	0.1	0.3	0.5	0.7	1	0.1	0.3	0.5
0	45	45	45	40	35	22	22	22
35	45	45	45	40	35	22	22	22
70	45	42	42	35	35	22	22	22
105	42	40	40	35	35	20	20	19
140	42	40	25	25	22	15	12	11
175	38	18				10	4.5	
210	35					6.5		

ERC3-RA4C

Lead 20

Orientation	Horizontal			Vertical				
	Acceleration (G)							
Speed (mm/s)	0.1	0.3	0.5	0.7	1	0.1	0.3	0.5
0	6	6	6	5	4.5	1.5	1.5	1.5
160	6	6	6	5	4.5	1.5	1.5	1.5
320	6	6	6	5	3	1.5	1.5	1.5
480	6	6	6	4.5	3	1	1	1
640	6	4	3	2		1	1	
800	4	3				0.5	0.5	

Lead 12

Orientation	Horizontal			Vertical				
	Acceleration (G)							
Speed (mm/s)	0.1	0.3	0.5	0.7	1	0.1	0.3	0.5
0	25	25	14	14	12	4.5	4.5	3.5
100	25	25	14	14	12	4.5	4.5	3.5
200	25	25	11	8	8	4.5	4.5	3.5
300	25	25	11	7	5.5	4	4	3.5
400	17.5	16.5	8	4	3.5	3.5	3.5	2.5
500	15	5.5	2	2		3.5	2	
600	10	3.5				2	1	
700	6	2				1	1	

Lead 6

Orientation	Horizontal			Vertical				
	Acceleration (G)							
Speed (mm/s)	0.1	0.3	0.5	0.7	1	0.1	0.3	0.5
0	40	40	31.5	30	25	12	12	10
50	40	40	31.5	30	25	12	12	10
100	40	40	31.5	24.5	21	12	12	10
150	40	40	24.5	17.5	17.5	11	11	7
200	40	40	21	14	12.5	8	8	5.5
250	35	24.5	17.5	14	11	7	7	4
300	28	21	12.5	12.5	8	5.5	5.5	4
350	24.5	17.5	9.5	5.5	5.5	4	3.5	3.5
400	17.5	9.5	7	4	2.5	3.5	2.5	2
450	17.5	5.5	2			1	1	1

Lead 3

Orientation	Horizontal			Vertical				
	Acceleration (G)							
Speed (mm/s)	0.1	0.3	0.5	0.7	1	0.1	0.3	0.5
0	40	40	40	40	35	18	18	17
25	40	40	40	40	35	18	18	17
50	40	40	40	40	35	18	18	17
75	40	40	40	40	35	16	16	16
100	40	40	40	40	35	16	15	15
125	40	40	40	40	30	16	12	10
150	40	40	40	30	25	10	8	5.5
175	36	36	35	25	20	10	5.5	5
200	36	28	28	19.5	14	7	5	4.5
225	36	16	14	10	6	4	3.5	2

ERC3-RA6C

Lead 24

Orientation	Horizontal			Vertical				
	Acceleration (G)							
Speed (mm/s)	0.1	0.3	0.5	0.7	1	0.1	0.3	0.5
0	20	13	11	10	8	3	3	2
200	20	13	11	10	8	3	3	2
400	20	13	11	10	8	2	2	2
600	13	7	5	3.5		2	2	
800	3	1						

Lead 16

Orientation	Horizontal			Vertical				
	Acceleration (G)							
Speed (mm/s)	0.1	0.3	0.5	0.7	1	0.1	0.3	0.5
0	45	40	30	28	26	8	8	8
140	45	40	30	28	26	8	8	8
280	45	34	30	24	18	6.5	5.5	5.5
420	45	22	17	13	10	5.5	4	3
560	9.5	5	2.5	1.5		2	1	
7								

High-output setting disabled Specification

■ Correlation diagrams of Speed and Payload

With the ERC3 series, due to the characteristics of the pulse motor, payload decreases as the speed increases. Use the chart below to confirm that the desired speed and payload requirements are met.

ERC3□-SA5C

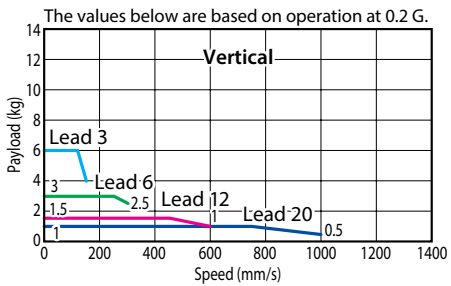
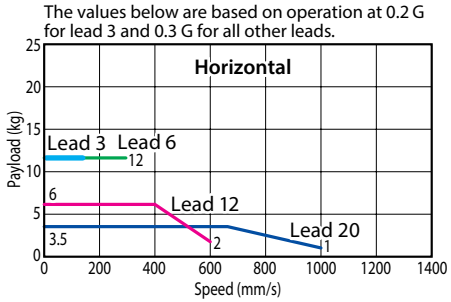

ERC3□-SA7C

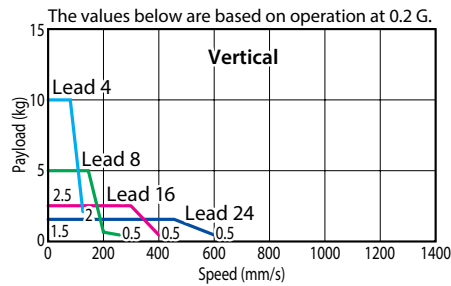
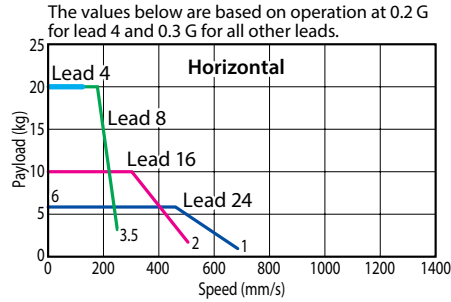

ERC3-RA4C

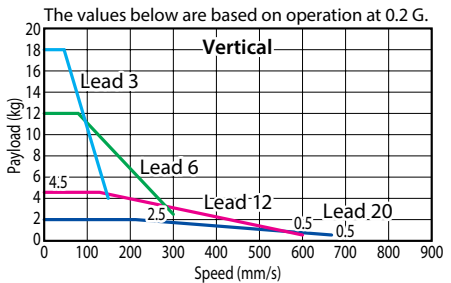
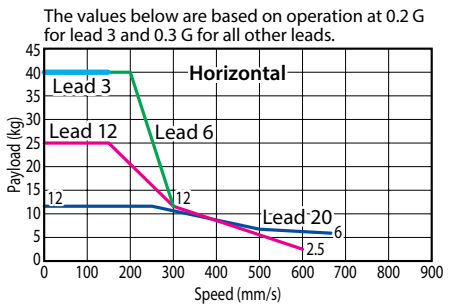

ERC3-RA6C

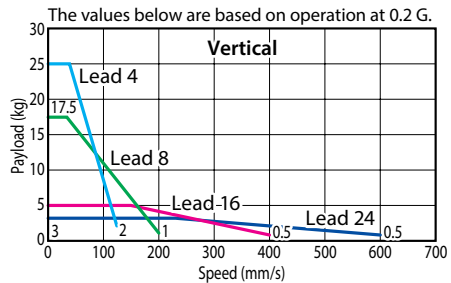
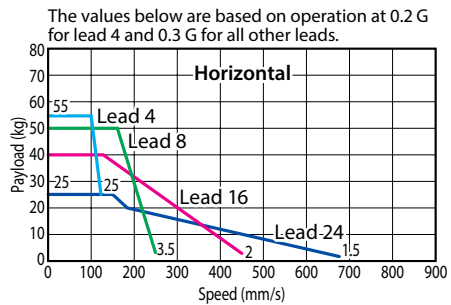

High-output setting disabled Specification

■ Stroke and Maximum Speed (Unit: mm/s)

•ERC3CR-SA5C

•ERC3D-SA5C

Stroke \ Lead	50~550 (every 50mm)	600 (mm)	650 (mm)	700 (mm)	750 (mm)	800 (mm)
20	1000	1000	900	785	690	610
12	600	570	490	425	375	330
6	300	285	245	215	185	165
3	150	140	120	105	90	80

•ERC3CR-SA7C

•ERC3D-SA7C

Stroke \ Lead	50~800 (every 50mm)
24	675 <600>
16	450 <400>
8	250
4	125

The value inside < > indicates vertical usage.

•ERC3-SA5C

Stroke \ Lead	50~550 (every 50mm)	600 (mm)	650 (mm)	700 (mm)	750 (mm)	800 (mm)
20	1000	935	795	680	585	510
12	600	560	475	405	350	300
6	300	280	235	200	175	150
3	150	140	115	100	85	75

•ERC3-SA7C

Stroke \ Lead	50~750 (every 50mm)	800 (mm)
24	675 <600>	
16	450 <400>	
8	250	245
4	125	120

The value inside < > indicates vertical usage.

•ERC3-RA4C

Stroke \ Lead	50~250 (every 50mm)	300 (mm)
20	667	667
12	600	485
6	300	240
3	150	120

•ERC3-RA6C

Stroke \ Lead	50~300 (every 50mm)
24	675 <600>
16	450 <400>
8	250 <200>
4	125

The value inside < > indicates vertical usage.

ERC3 controller specification



■ Model number NP/PN/SE/PLN/PLP
Controller part of actuator with built-in controller

List of Models

Controller type	CON type					MEC type		
Operation mode	Positioner mode			Pulse-train control mode		Positioner mode		
I/O type	PIO		SIO	NPN	PNP	PIO		SIO
	NPN	PNP				NPN	PNP	
Type (I/O type)	NP	PN	SE	PLN	PLP	NP	PN	SE
Position points	16 points		512 points (When the PIO converter or gateway unit is used)	—	—	3 points		2 points/ 3 points
Description	Basic type	Basic type	The PIO converter or gateway unit can be used. (Note)	When pulse trains are used	When pulse trains are used	3-point movement	3-point movement	The Quick Teach and PIO converter or gateway unit can be used. (Note)
External view								
Standard price	—							

(Note) The PIO converter and gateway unit cannot be used at the same time.

Model number

⑦&⑨ refers to the I/O type and controller type shown in the above table.

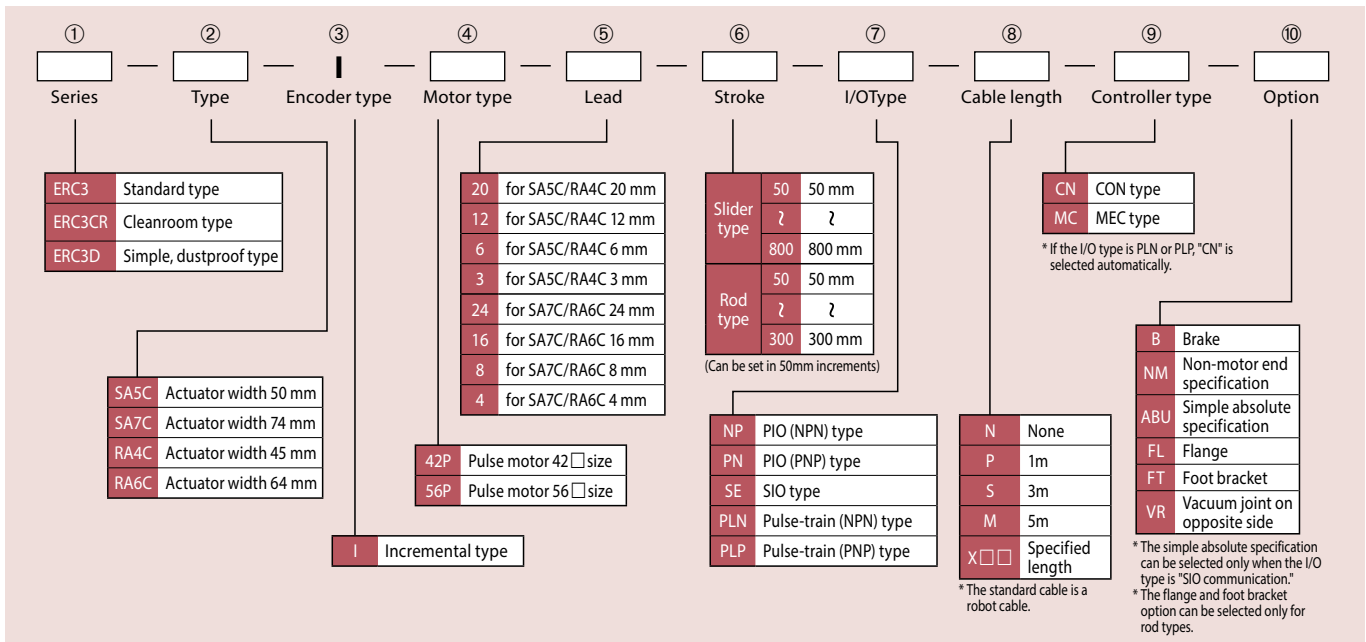

System Configuration

PIO Type/Pulse-train type

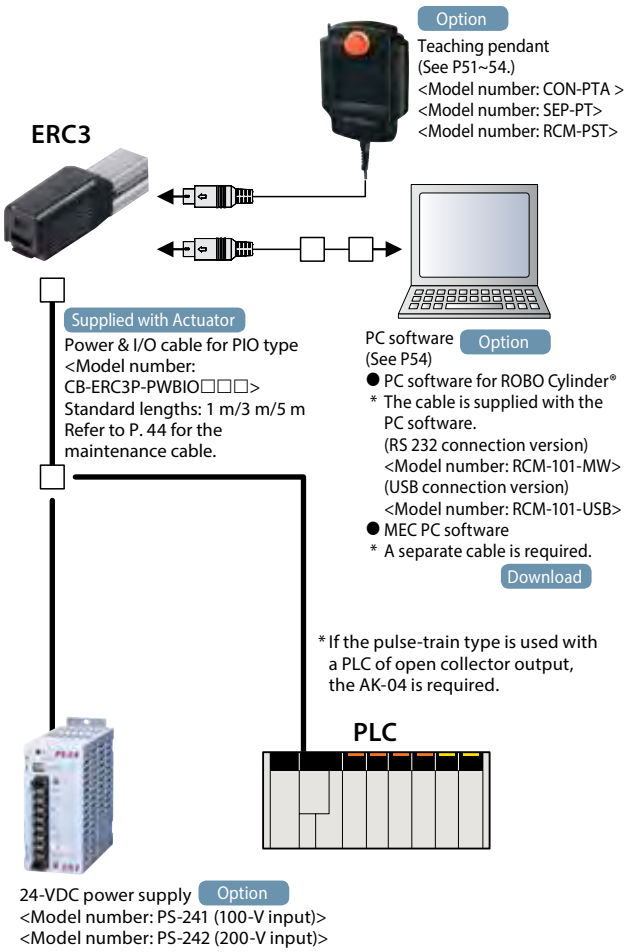

SIO Type

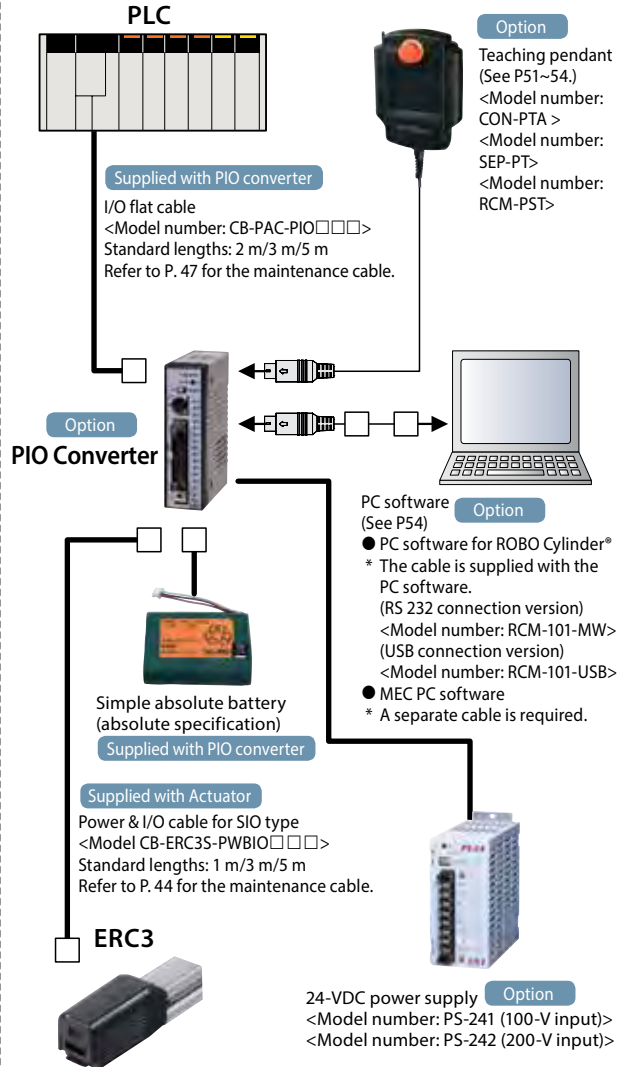

PC Wiring Diagram

The SIO connector is used to connect a teaching tool.

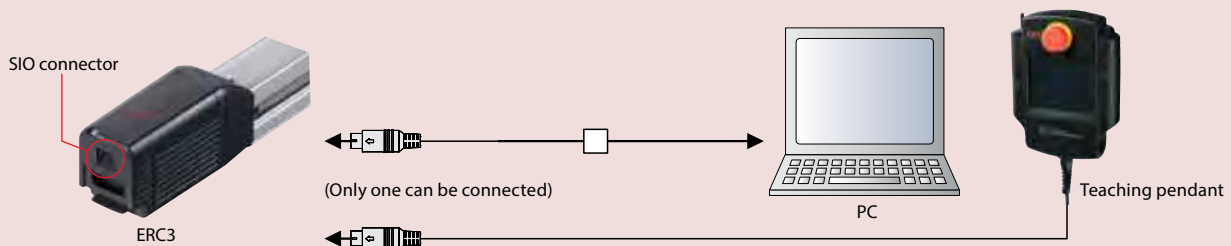

List of Base Controller Specifications

Item	Description	
Power supply voltage	24 VDC±10%	
Load current (including current consumed for control)	High-output setting enabled: 3.5 A rated/4.2 A max. High-output setting disabled: 2.2A	
Heat output	High-output setting enabled: 8 W High-output setting disabled: 5W	
Rush current (Note 1)	8.3A	
Momentary power failure resistance	MAX. 500µs	
Motor control method	Field-weakening vector control	
Supported encoder	Incremental encoder of 800 pulses/rev in resolution	
Actuator cable length	10 m max.	
Serial communication interface (SIO port)	RS485: 1 channel (conforming to Modbus protocol RTU/ASCII) / Speed: 9.6 to 230.4 kbps Actuators can be controlled via serial communication in a mode other than pulse-train	
External interface PIO specification	Dedicated 24-VDC signal input/output (NPN or PNP selected)—Up to 6 input points, up to 4 output points Cable length: 10m max.	
Data setting/input method	PC software, touch-panel teaching pendant, quick teach	
Data retention memory	Position data and parameters are saved in the non-volatile memory (There is no limit to the number of times the memory can be written.)	
Operation mode	Positioner mode/Pulse-train control mode	
Number of positions in positioner mode	Standard 8 points, maximum 16 points Note) Positioning points vary depending on the selected PIO pattern.	
Pulse-train interface	Input pulse	Differential method (line driver method): 200 kpps max. / Cable length: 10m max.
		Open collector method: Not supported * If the host is of open collector output type, use the optional AK-04 (sold separately) to convert open collector pulses to differential pulses.
	Command pulse magnification (electronic gear ratio: A/B)	1/50 < A/B < 50/1 Setting range of A and B (set by parameters): 1 to 4096
	Feedback pulse output	None
LED indicators (installed on the motor unit)	Servo ON (green), servo OFF (unlit), emergency stop (red), alarm (red), resetting (orange)	
Isolation resistance	500 VDC, 10 MΩ or more	
Electric shock protection mechanism	Class I basic isolation	
Cooling method	Natural air cooling	
Environment	Ambient operating temperature	0 to 40°C
	Ambient operating humidity	85%RH or less (non-condensing)
	Ambient storage temperature	-20 to 70°C (excluding batteries)
	Operating altitude	Altitude 1000m or less
	Protection degree	IP20
	Cooling method	Natural air cooling
	Vibration resistance	Number of vibrations: 10 to 57 Hz/Amplitude: 0.075 mm (Test conditions) Number of vibrations: 57 to 150 Hz/Acceleration: 9.8 m/s ² Sweep time in X/Y/Z directions: 10 minutes/Number of sweeps: 10 times
	Impact	(Test conditions) 150mm/sec ² , 11mm/sec, sinusoidal half pulse, 3 times each in X, Y and Z directions

Note 1 Rush current will flow for approx. 5msec after the power is turned on (at 40°C).
Take note that the value of rush current varies depending on the impedance of the power line.

Emergency Stop Circuit

The ERC3 series has no built-in emergency stop circuit, so the customer must provide an emergency stop circuit. Refer to the operation manual for details on the emergency stop circuit.

Positioner mode

I/O specification (PIO type)

Input Part

Item	Specification
Input points	6 points
Input voltage	24 VDC ±10%
Input current	5mA/1 circuit
Leak current	1mA/point max.

* The input circuit is not isolated from signals input from external equipment.

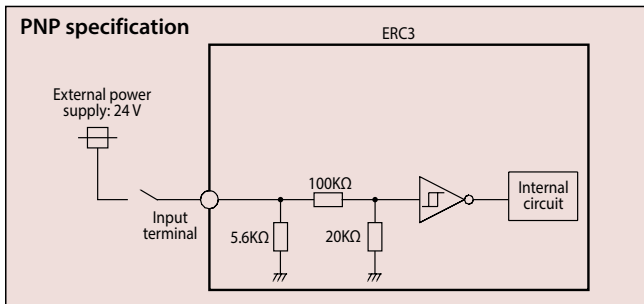
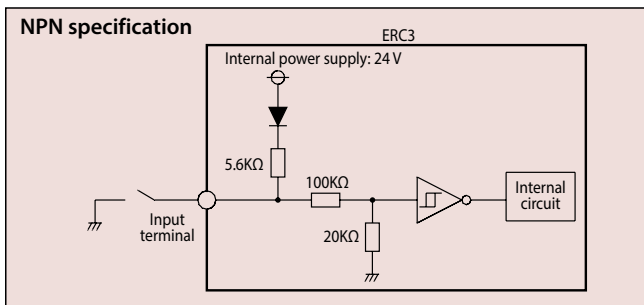

Output Part

Item	Specification
Output points	4 points
Load voltage	24 VDC ±10%
Maximum load current	5mA/1 circuit
Residual voltage	2 V or less

* The output circuit is not isolated from signals output to external equipment.

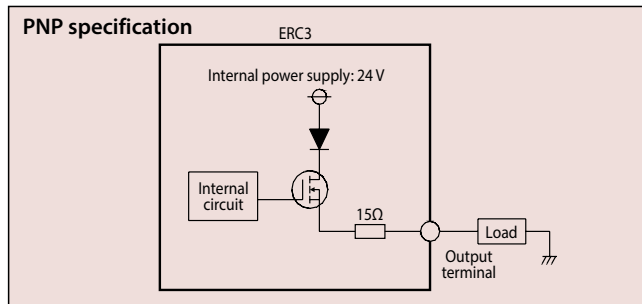
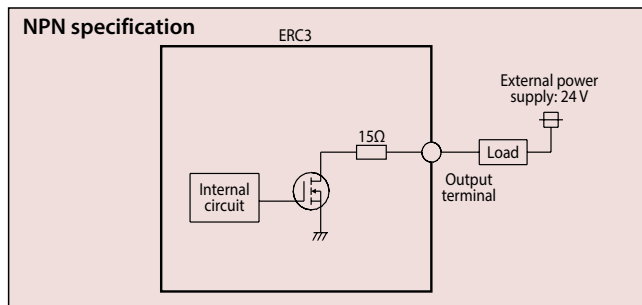

I/O Signal Table (PIO Type) [ERC3 and PLC Connected Directly]

Pin number	Category	Controller type PIO function	CN (CON type) Parameter No. 25 (PIO pattern) selection			MC (MEC type) Selected on teaching pendant or in PC software	
			0	1	2	Standard/Movement between 2 points (single solenoid)	2 inputs/Movement among 3 points
			8-point type	Solenoid type	16-point type		
	Input	Number of positioning points	8 points	3 points	16 points	2 points	3 points
		Home return signal	○	×	×	×	×
		Jog signal	×	×	×	×	×
		Teaching signal (writing of current position)	×	×	×	×	×
		Brake release	×	×	×	×	×
		Moving signal	×	×	×	×	×
		Zone signal	○	×	○	×	×
	Output	Position zone signal	×	×	○	×	×
A1		Frame ground			FG		
B1		+24V for control power supply			CP		
A2	-						
B2	0V for control power supply			GND			
A3	External brake release input			BK			
B3	+24V for motor power supply			MP			
A4	Emergency stop input			EMG			
B4	0V for motor power supply			GND			
A5	-						
B5	-						
A6	-						
B6	-						
A7	-						
B7	-						
A8	-						
B8	-						
A9	Input	IN0	PC1	ST0	PC1	ST0	ST0
B9		IN1	PC2	ST1	PC2	—	ST1
A10		IN2	PC4	ST2	PC4	RES	RES
B10		IN3	HOME	—	PC8	—	—
A11		IN4	CSTR	RES	CSTR	—	—
B11	IN5	*STP	*STP	*STP	—	—	
A12	Output	OUT0	PEND	PE0	PEND	LS0/PE0	LS0/PE0
B12		OUT1	HEND	PE1	HEND	LS1/PE1	LS1/PE1
A13		OUT2	ZONE1	PE2	PZONE/ZONE1	HEND	LS2/PE2
B13		OUT3	*ALM	*ALM	*ALM	*ALM	*ALM

(Note) Signals marked with an asterisk (*) (ALM/STP) are negative logic signals so they are normally on.

I/O Signal Table (SIO Type) [ERC3 and PLC Connected via PIO Converter]

Pin number	Category	Controller type PIO function	CN (CON type)					MC (MEC type)		
			Parameter No. 25 (PIO pattern) selection					Selected on teaching pendant or in PC software		
			0	1	2	3	4	5	Standard/Movement between 2 points (single solenoid)	2 inputs/Movement among 3 points
			Positioning mode	Teaching mode	256-point mode	512-point mode	Solenoid valve mode 1	Solenoid valve mode 2		
		Number of positioning points	64 points	64 points	256 points	512 points	7 points	3 points	2 points	3 points
	Input	Home return signal	○	○	○	○	○	×	×	×
		Jog signal	×	○	×	×	×	×	×	×
		Teaching signal (writing of current position)	×	○	×	×	×	×	×	×
		Brake release	○	×	○	○	○	○	×	×
	Output	Moving signal	○	○	×	×	×	×	×	×
		Zone signal	○	×	×	×	○	○	×	×
		Position zone signal	○	○	○	×	○	○	×	×
1A	—									
2A	—									
3A	—									
4A	—									
5A	Input	IN0	PC1	PC1	PC1	PC1	ST0	ST0	ST0	ST0
6A		IN1	PC2	PC2	PC2	PC2	ST1	ST1(JOG+)	—	ST1
7A		IN2	PC4	PC4	PC4	PC4	ST2	ST2 *1	RES	RES
8A		IN3	PC8	PC8	PC8	PC8	ST3	—	—	—
9A		IN4	PC16	PC16	PC16	PC16	ST4	—	—	—
10A		IN5	PC32	PC32	PC32	PC32	ST5	—	—	—
11A		IN6	—	MODE	PC64	PC64	ST6	—	—	—
12A		IN7	—	JISL	PC128	P128	—	—	—	—
13A		IN8	—	JOG+	—	PC256	—	—	—	—
14A		IN9	BKRL	JOG-	BKRL	BKRL	BKRL	BKRL	—	—
15A		IN10	—	—	—	—	—	—	—	—
16A		IN11	HOME	HOME	HOME	HOME	HOME	—	—	—
17A		IN12	*STP	*STP	*STP	*STP	*STP	—	—	—
18A		IN13	CSTR	CSTR/PWRT	CSTR	CSTR	—	—	—	—
19A		IN14	RES	RES	RES	RES	RES	RES	—	—
20A	IN15	SON	SON	SON	SON	SON	SON	—	—	
1B	Output	OUT0	PM1(ALM1)	PM1(ALM1)	PM1(ALM1)	PM1(ALM1)	PE0	LSO	LSO/PE0	LSO/PE0
2B		OUT1	PM2(ALM2)	PM2(ALM2)	PM2(ALM2)	PM2(ALM2)	PE1	LS1(TRQS)	LS1/PE1	LS1/PE1
3B		OUT2	PM4(ALM4)	PM4(ALM4)	PM4(ALM4)	PM4(ALM4)	PE2	LS2 *1	HEND	LS2/PE2
4B		OUT3	PM8(ALM8)	PM8(ALM8)	PM8(ALM8)	PM8(ALM8)	PE3	—	*ALM	*ALM
5B		OUT4	PM16	PM16	PM16	PM16	PE4	—	—	—
6B		OUT5	PM32	PM32	PM32	PM32	PE5	—	—	—
7B		OUT6	MOVE	MOVE	PM64	PM64	PE6	—	—	—
8B		OUT7	ZONE1	MODES	PM128	PM128	ZONE1	ZONE1	—	—
9B		OUT8	PZONE/ZONE2	PZONE/ZONE1	PZONE/ZONE1	PM256	PZONE/ZONE2	PZONE/ZONE2	—	—
10B		OUT9	—	—	—	—	—	—	—	—
11B		OUT10	HEND	HEND	HEND	HEND	HEND	HEND	—	—
12B		OUT11	PEND	PEND/WEND	PEND	PEND	PEND	—	—	—
13B		OUT12	SV	SV	SV	SV	SV	SV	—	—
14B		OUT13	*EMGS	*EMGS	*EMGS	*EMGS	*EMGS	*EMGS	—	—
15B		OUT14	*ALM	*LM	*ALM	*ALM	*ALM	*ALM	—	—
16B	OUT15	LOAD/TRQS *ALML	*ALML	LOAD/TRQS *ALML	LOAD/TRQS *ALML	LOAD/TRQS *ALML	*ALML	—	—	
17B	—									
18B	—									
19B	—									
20B	—									

(Note) In the table above, codes in () indicate functions effective before the home return. * indicates a negative logic signal.

PM1 to PM8 serve as alarm binary code output signals when an alarm occurs.

*1 These signals are invalid before the home return.

Explanation of Signal Names

Category	Signal name	Signal abbreviation	Function overview
Input	PTP strobe (start signal)	CSTR	The actuator starts moving to the position set by the command position number.
	Command position number	PC1~PC256	This signal is used to input the position number of the position to move the actuator to (binary input).
	Forced brake release	BKRL	The brake is forcibly released.
	Pause	*STP	When this signal turns OFF while the actuator is moving, the actuator will decelerate to a stop. The remaining travel is put on hold while the actuator is stopped and will resume when the signal turns ON.
	Reset	RES	Present alarms are reset when this signal turns ON. By turning ON this signal while the actuator is paused (*STP signal is OFF), the remaining travel can be cancelled.
	Servo ON	SON	The servo is ON while this signal is ON, and OFF while the signal is OFF.
	Home return	HOME	Home return operation is performed when this signal is turned ON.
	Teaching mode	MODE	The actuator switches to the teaching mode when this signal turns ON. The mode will not change unless the CSTR, JOG+ and JOG- signals are all OFF and the actuator is not operating.
	Jog/inching switching	JISL	The actuator can be jogged with a JOG+ or JOG- command while this signal is OFF. The actuator operates by inching with a JOG+ or JOG- command while this signal is ON.
	Jog	JOG + JOG -	When the JISL signal is OFF, the actuator jogs in the positive direction upon detection of the ON edge of the JOG+ signal, or in the negative direction upon detection of the ON edge of the JOG- signal. The actuator decelerates to a stop if the OFF edge is detected while jogging in each direction. The actuator operates by inching when the JISL signal is ON.
	Current position write	PWRT	When a position number is specified and this signal is turned ON for 20 ms or more in the teaching mode, the current position is written to the specified position number.
	Start signal	ST0~ST6	In the solenoid mode, the actuator moves to the specified position when this signal turns ON.
Output	Positioning complete	PEND/INP	This signal turns ON when the actuator reaches the positioning band after moving. The PEND signal does not turn OFF even when the actuator moves beyond the positioning band, but the INP signal turns OFF. A parameter is used to switch between PEND and INP.
	Completed position number	PM1~PM256	The position number of the position reached upon completion of positioning is output (by a binary signal).
	Home return complete	HEND	This signal turns ON upon completion of home return. It will remain ON until the home position is lost.
	Zone signal 1	ZONE1	This signal turns ON when the current position of the actuator falls within the parameter-set range.
	Zone signal 2	ZONE2	
	Position zone	PZONE	This signal turns ON when the current position of the actuator enters the range set in the position data table while moving to a position. This signal can be used with ZONE1, but the PZONE signal is effective only when moving to a set position.
	Alarm	*ALM	This signal remains ON while the controller is normal, and turns OFF when an alarm occurs.
	Moving	MOVE	This signal is ON while the actuator is moving (also during home return and push-motion operation).
	Servo ON	SV	This signal is ON when the servo is ON.
	Emergency stop output	*EMGS	This signal is ON when the controller is not in the emergency stop mode, and turns OFF when an emergency stop is actuated.
	Teaching mode output	MODES	This signal turns ON when the actuator enters the teaching mode due to an input of the MODE signal. It turns OFF when the actuator returns to the normal mode.
	Write complete	WEND	This signal is OFF immediately after switching to the teaching mode, and turns ON the moment the writing per the PWRT signal is completed. This signal also turns OFF when the PWRT signal turns OFF.
	Current position number	PE0~PE6	This signal turns ON when the actuator completes moving to the target position in the solenoid mode.
	Limit switch output	LS0~LS2	This signal turns ON when the current position of the actuator enters the positioning band (\pm) around the target position. If the home return has been completed, this signal is output even before a move command is issued or the servo is OFF.
	Load output judgment status	LOAD	This signal turns ON when the in-certification-range command torque exceeds the threshold.
Torque level status signal	TRQS	This signal turns ON when the motor current reaches the threshold.	
Minor failure alarm	*ALML	This signal is output when a message-level alarm generates.	

(Note) In the table above, * indicates a negative logic signal.

PIO 8-point Type (ERC3 and PLC Connected Directly)

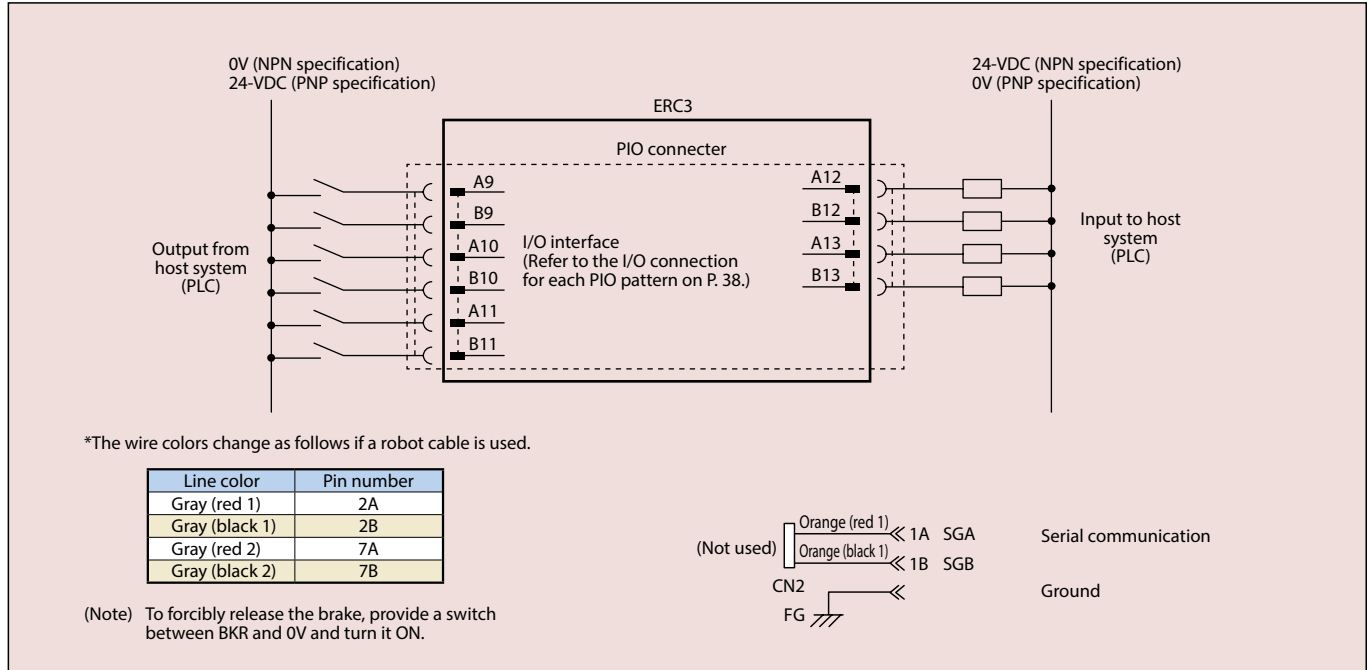

PIO Positioning Mode (Standard Type) (ERC3 and PLC Connected via PIO Converter)

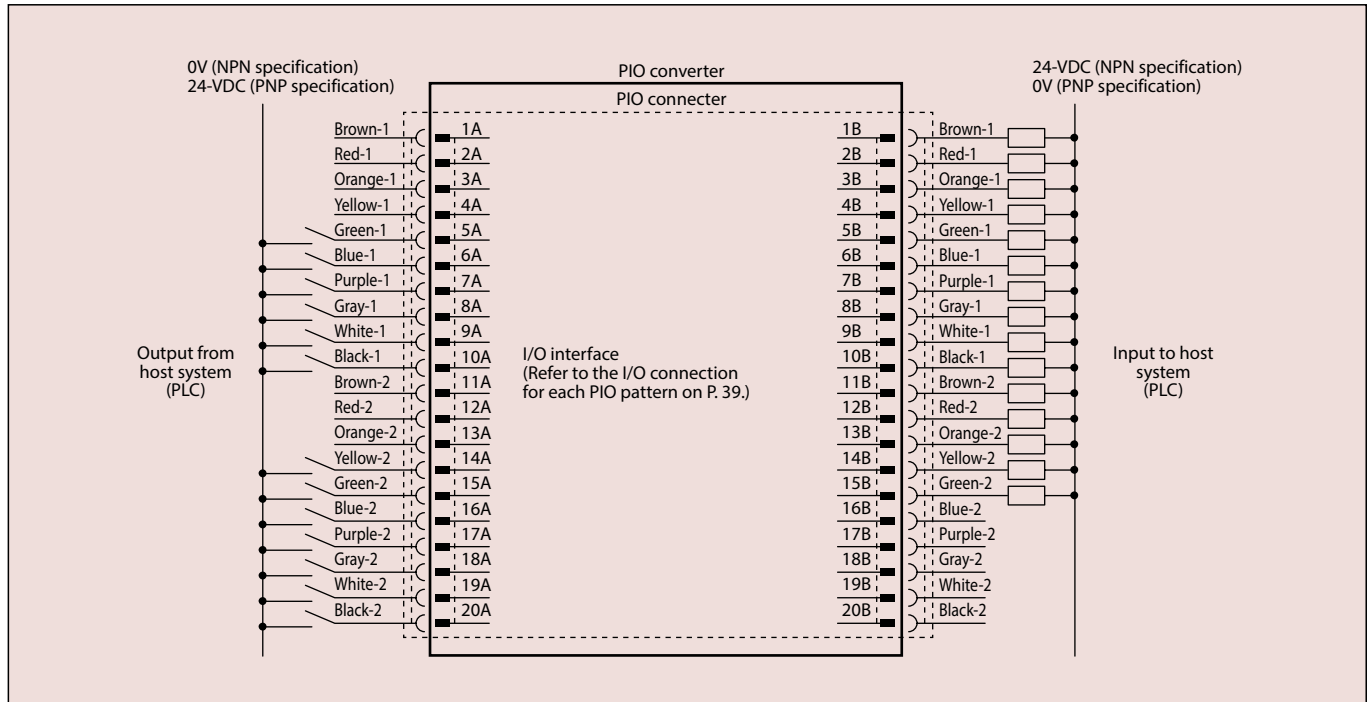

Pulse-train control mode

I/O specification (Pulse-train type)

Input Part

Code	Remarks
Differential input voltage range	26C31 or equivalent
Maximum cable length	Differential line driver method: 10m max. Open collector method (AK-04 used): 2m max.
Maximum number of input pulses	Differential line driver method: 200 kpps max. Open collector method (AK-04 used): 60kpps max.

* If the user-side I/O is of open collector type, use the AK-04.

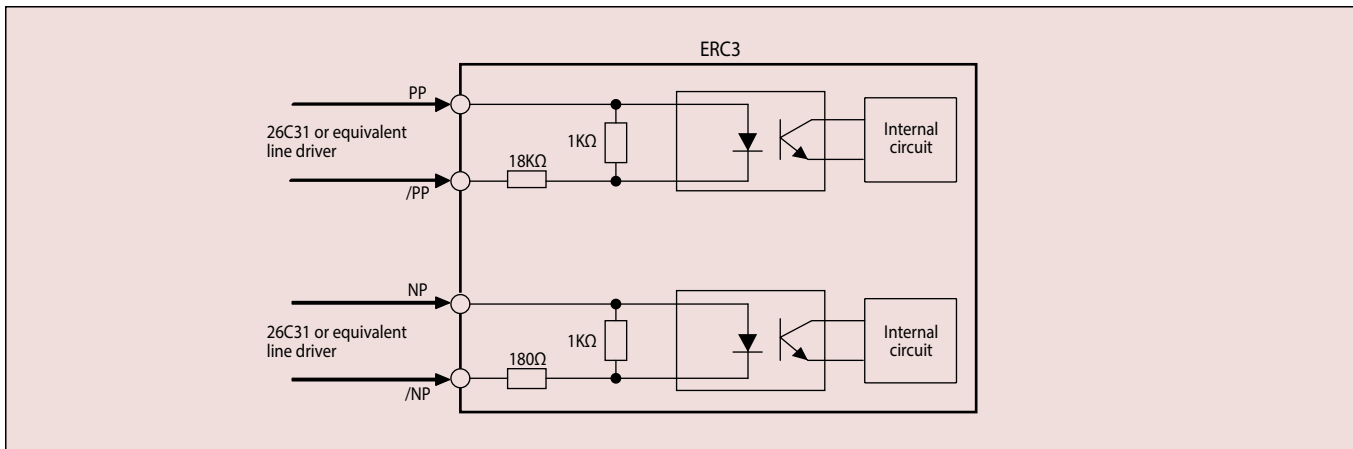

Pulse-train Control Circuit

Host Unit = Differential Type

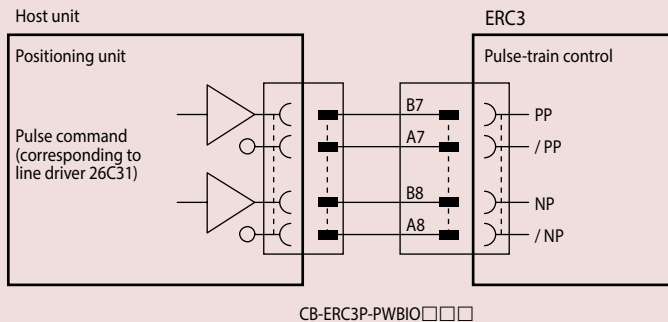

Host Unit = Open Collector Type

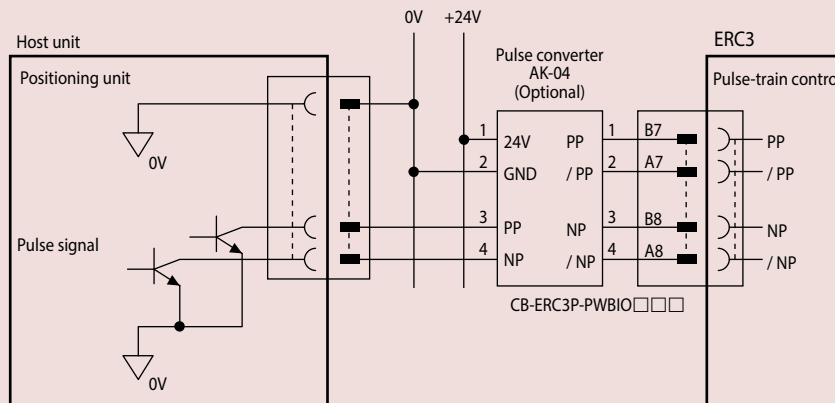

* The AK-04 (optional) is needed to input pulses.

* Use the same power supply for open collector input/output to/from the host and for the AK-04.

I/O Signals for the Pulse-train Control Mode

The table below lists the signal assignments for the flat cable for the pulse-train control mode. Connect an external device (such as PLC) according to this table.

[1] Positioning Operation - PIO Pattern: 0

Pin number	Category	I/O number	Signal abbreviation	Signal name	Description of function
A1	Frame ground		FG	—	Frame ground.
B1	+24 V for control power supply		CP	—	+24 V of the control power supply is input.
A2				—	
B2	0 V for control power supply		GND	—	0 V of the control power supply.
A3	External brake release input		BK	—	This signal is used to release the brake externally. The brake is released when +24 V is input.
B3	+24 V for motor power supply		MP	—	+24 V of the motor power supply is input.
A4	Emergency stop input		EMG	—	Input signal for emergency stop.
B4	0 V for motor power supply		GND	—	+24 V of the motor power supply is input.
A5					
B5					
A6					
B6					
A7			/PP	Command pulse	
B7			PP	Command pulse	
A8			/NP	Command pulse	
B8			NP	Command pulse	
A9	Input	IN0	SON	Servo ON	The servo is ON while this signal is ON, and OFF while the signal is OFF.
B9		IN1	TL	Torque limit selection	When this signal is turned ON, the motor torque is limited to the value set by a parameter.
A10		IN2	HOME	Home return	Home return operation is performed when this signal is turned ON.
B10		IN3	RES	Reset	Present alarms are reset when this signal is turned ON.
A11		IN4	—		
B11	IN5	—			
A12	Output	OUT0	SV	Servo ON status	This signal turns ON when the servo is ON.
B12		OUT1	INP	Positioning complete	This signal turns ON when the amount of remaining travel pulses in the deviation counter falls within the positioning band.
A13		OUT2	HEND	Home return complete	This signal turns ON upon completion of home return.
B13		OUT3	*ALM	Controller alarm status	This signal turns ON when the controller is normal, and turns OFF when an alarm generates.

* indicates a negative logic signal. Negative logic signals are normally ON while the power is supplied, and turn OFF when the signal is output.

[2] Push-motion Operation - PIO Pattern: 1

Pin number	Category	I/O number	Signal abbreviation	Signal name	Description of function
A1	Frame ground		FG	—	Frame ground.
B1	+24 V for control power supply		CP	—	+24 V of the control power supply is input.
A2				—	
B2	0 V for control power supply		GND	—	0 V of the control power supply.
A3	External brake release input		BK	—	This signal is used to release the brake externally. The brake is released when +24 V is input.
B3	+24 V for motor power supply		MP	—	+24 V of the motor power supply is input.
A4	Emergency stop input		EMG	—	Input signal for emergency stop.
B4	0 V for motor power supply		GND	—	+24 V of the motor power supply is input.
A5					
B5					
A6					
B6					
A7			/PP	Command pulse	
B7			PP	Command pulse	
A8			/NP	Command pulse	
B8			NP	Command pulse	
A9	Input	IN0	SON	Servo ON	The servo is ON while this signal is ON, and OFF while the signal is OFF.
B9		IN1	TL	Torque limit selection	When this signal is turned ON, the motor torque is limited to the value set by a parameter.
A10		IN2	HOME	Home return	Home return operation is performed when this signal is turned ON.
B10		IN3	RES	Reset	This signal serves as a reset signal when the torque is not limited (torque TL signal is OFF). When this signal turns ON, present alarms are reset.
			DCLR	Deviation counter clear	This signal serves as a deviation counter signal when the torque is limited (torque TL signal is ON). This signal clears the deviation counter.
A11	IN4	—			
B11	IN5	—			
A12	Output	OUT0	SV	Servo ON status	This signal turns ON when the servo is ON.
B12		OUT1	INP	Positioning complete	This signal serves as a positioning complete signal when the torque is not limited (torque TL signal is OFF). It turns ON when the remaining travel pulses in the deviation counter are within the range of positioning band.
			TLR	Torque limited	This signal serves as a torque limited signal when the torque is limited (torque TL signal is ON). If the torque is limited, this signal turns ON when the torque limit is reached.
A13		OUT2	HEND	Home return complete	This signal turns ON upon completion of home return.
B13	OUT3	*ALM	Controller alarm status	This signal turns ON when the controller is normal, and turns OFF when an alarm generates.	

* indicates a negative logic signal. Negative logic signals are normally ON while the power is supplied, and turn OFF when the signal is output.

Cable/Maintenance Parts

Power & I/O Cable for PIO Type

Model number **CB-ERC3P-PWBIO** □□□

*□□□ indicates the cable length (L). A desired length can be specified up to 10m. Example: 080=8m

* The standard cable is a robot cable.

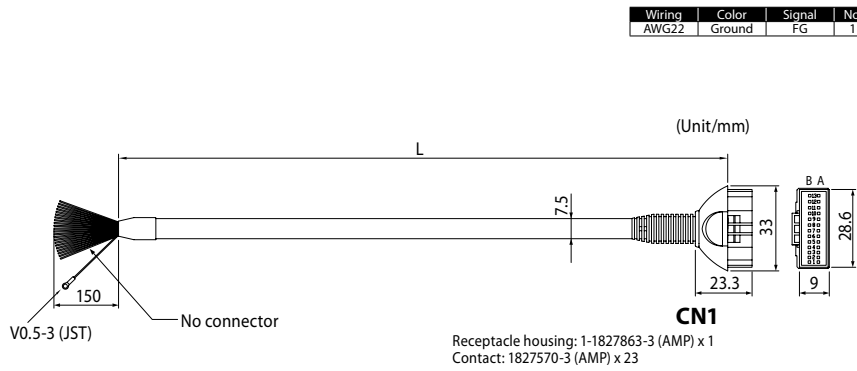

Minimum bending R: r = 45mm or more (when movable type is used)

Wiring	Color	Signal	No.
AWG22	Ground	FG	1

No.	Signal	Color	Wiring
A1	FG	Ground	AWG22
A2	—	—	—
A3	BK	Red 1	—
A4	EMG	Orange1	AWG28
A5	—	—	—
A6	—	—	—
A7	—	Blue	—
A8	—	Gray	—
A9	IN0	Brown2	—
A10	IN2	Orange2	—
A11	IN4	Green2	AWG28
A12	OUT0	Purple2	—
A13	OUT2	White2	—
B1	CP	Brown	—
B2	CP_GND	Red	AWG22
B3	MP	Orange	—
B4	MP_GND	Yellow	AWG19
B5	—	Green	—
B6	—	Brown1	—
B7	—	Purple	—
B8	—	White	—
B9	IN1	Red2	AWG28
B10	IN3	Yellow2	—
B11	IN5	Blue2	—
B12	OUT1	Gray2	—
B13	OUT3	Black	—

Power & I/O Cable for SIO Type

Model number **CB-ERC3S-PWBIO** □□□

*□□□ indicates the cable length (L). A desired length can be specified up to 10m. Example: 080=8m

* The standard cable is a robot cable.



Minimum bending R: r = 36 mm or more (when movable type is used)

Wiring	Signal	No.
AWG28	SB	1
—	SA	2
—	BK	3
—	EMG	4
—	BAT	5
—	BGND	6
AWG22	CP	7
—	CP_GND	8
AWG19 (AWG22)	MP	9
—	MP_GND	10
—	N.C	11
—	N.C	12
—	N.C	13
AWG22	FG	14

No.	Signal	Wiring
A1	FG	AWG22
A2	—	—
A3	BK	AWG28
A4	EMG	—
A5	BGND	AWG22
A6	BAT	AWG28
B1	CP	—
B2	CP_GND	AWG22
B3	MP	—
B4	MP_GND	AWG19
B5	SA	AWG28
B6	SB	—
A7	N.C	—
B7	N.C	—
A8	N.C	—
B8	N.C	—
A9	N.C	—
B9	N.C	—
A10	N.C	—
B10	N.C	—
A11	N.C	—
B11	N.C	—
A12	N.C	—
B12	N.C	—
A13	N.C	—
B13	N.C	—

SIO Communication Cable (for Quick Teach)

Model number **CB-PST-SIO050**

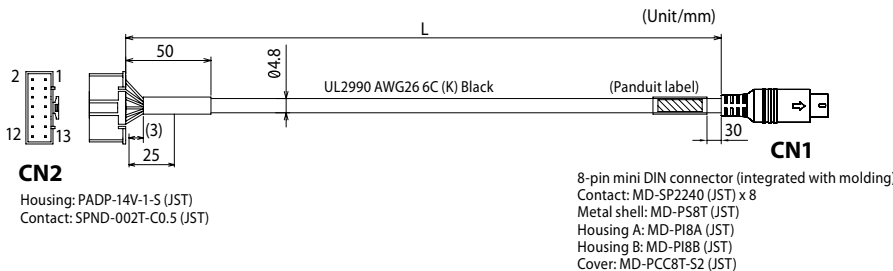
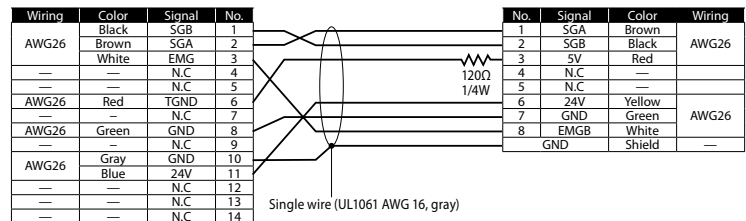

8-pin mini DIN connector (integrated with molding)
 Contact: MD-SP2240 (JST) x 8
 Metal shell: MD-PS8T (JST)
 Housing A: MD-PI8A (JST)
 Housing B: MD-PI8B (JST)
 Cover: MD-PCC8T-S2 (JST)

PIO Converter <RCB-CV>



Realizing controller functions of the next higher class with the ERC3 series

When connected to the PIO converter, the ERC3 series can demonstrate functions equivalent to the RCP4 controller "PCON-CA." Use the PIO converter if you want to configure a high-function system using the ERC3 series, use the absolute function or monitor the status of the actuator.

■ Features

■ Increased maximum number of positioning points

While the maximum number of positioning points supported by the ERC3 series' built-in controller is 16, it increases to 512 when the PIO converter is connected. Connecting the PIO converter also increases the numbers of I/O signals, allowing for complex controls and connection with peripheral equipment.



■ Supporting the simple absolute mode

The standard encoder of the ERC3 series is of incremental type. Once the power is turned off, therefore, the actuator's current position is lost and home return operation will be required next time the actuator is started. When the PIO converter is connected, the ERC3 lets you select the simple absolute mode. Home return operation is not required while the encoder is in the simple absolute mode, because the current position is retained.

* To use the simple absolute function, the PIO converter must be of the simple absolute type (equipped with the simple absolute battery) and the actuator must also be of the simple absolute specification.

* Among the different I/O types, only the serial communication type supports the simple absolute function.

In the simple absolute mode...

Home return operation is no longer required

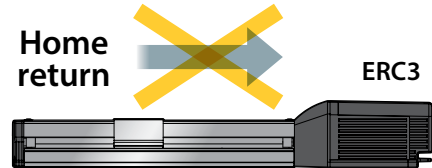

The actuator can be operated immediately after reconnecting the power.

■ Status LEDs indicating the operating status of the actuator

The PIO converter lets you check the following status using the status LEDs provided on the front panel (optional).

- Command current ratio level
- Alarm code
- PIO input terminal status
- PIO output terminal status

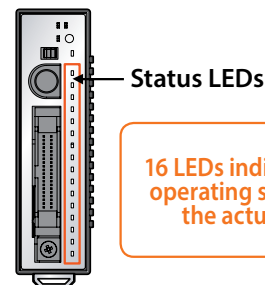

16 LEDs indicate the operating status of the actuator.

Calendar function for checking when errors occurred

The PIO converter has a calendar function that lets you check the details of past alarms, such as when each alarm occurred, by connecting the teaching pendant and PC software to the PIO converter. This function is useful when analyzing alarms.

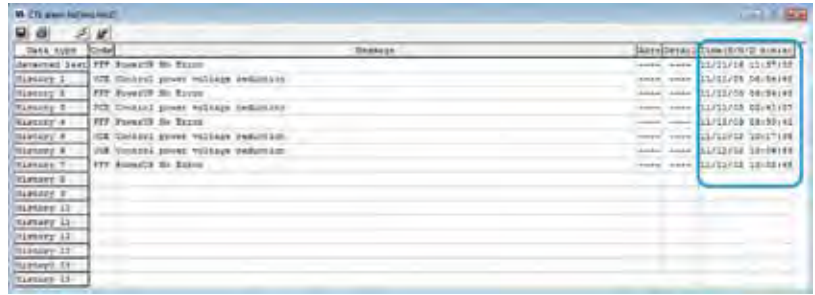

Brake release switch for at-will release of the brake

If your ERC3 actuator comes with a brake, the brake can be turned on/off freely using the brake release switch on the front panel of the PIO converter. To release the brake, turn the switch to the "RLS" position.

* If the actuator is used vertically, hold the actuator in place before releasing the brake.

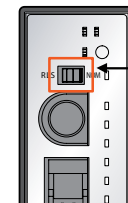

Brake release switch
Release the brake: RLS
Normal: NOM

Model Configuration

RCB Series	Type	I/O type	I/O cable length	Simple absolute function supported
CV	Built-in power cutoff relay type (standard)	NP	0	(No entry)
CVG	External power cutoff relay type	PN	2	AB
		NPM	3	ABUN
		PNM	5	

* Select "NPM/PNM" if you want to use the functions of monitoring LEDs on the front panel.

Base Specifications

Item	Description	
Number of connected axes	ERC3 1 axis	
Power supply voltage	24VDC ±10%	
Control power capacity	0.8A max.	
Heat output	1.3W	
Momentary power failure resistance	500µs max.	
Serial communication interface (SIO port)	RS485: 1 channel (conforming to Modbus protocol RTU/ASCII) / Speed: 9.6 to 230.4 kbps Actuators can be controlled via serial communication.	
External interface	Dedicated 24-VDC signal input/output (NPN or PNP selected)—Up to 16 input points, up to 16 output points / Cable length: 10 m max.	
Data setting/input method	PC software, touch-panel teaching pendant	
Operation Mode	Positioner mode	
Number of positions in positioner mode	Standard 64 points, maximum 512 points Note) Positioning points vary depending on the selected PIO pattern.	
LED display (installed on the front panel)	Status indicator LED - Steady green light: Servo ON / Blinking green light: Auto servo OFF / Steady red light: Alarm present Absolute battery status indicator LED - Green: Fully charged / Orange: Charging / Red: Not connected Absolute reset status LED - Green: Absolute reset complete / Red: Absolute reset not yet complete LED0 to LED15 (optional): 4 different statuses can be indicated by changing the switch setting. Command current ratio, alarm code, BK input status, PIO output status	
Electromagnetic brake forced release switch (installed on the front panel)	Switched between NOM (standard) and BK RLS (forced releases)	
Isolation resistance	500VDC, 10MΩ or more	
Electric shock protection mechanism	Class I basic isolation	
Cooling method	Natural air cooling	
Environment	Ambient operating temperature	0 to 40°
	Ambient operating humidity	85%RH or less (non-condensing)
	Ambient storage temperature	-20 to 70° (excluding batteries)
	Operating altitude	Altitude 1000m or less
	Protection degree	IP20
	Vibration resistance	Number of vibrations: 10 to 57 Hz / Amplitude: 0.075 mm Number of vibrations: 57 to 150 Hz / Acceleration: 9.8 m/s ² Sweep time in X/Y/Z directions: 10 minutes / Number of sweeps: 10 times
Consumable parts	Weight	103g or less, or 287g (including 190g for the battery) or less for the simple absolute specification
	External Dimensions	25W×90H×98D
Consumable parts	RTC backup capacitor: Approx. 5 years* Drive-source cutoff relay: Approx. 100,000 actuations Absolute battery: Approx. 3 years	

*When the power is supplied 12 hours a day at an ambient temperature of 40°C and the actuator is stopped (power turned off) 12 hours a day in an ambient temperature of 20°C.

Connection Example

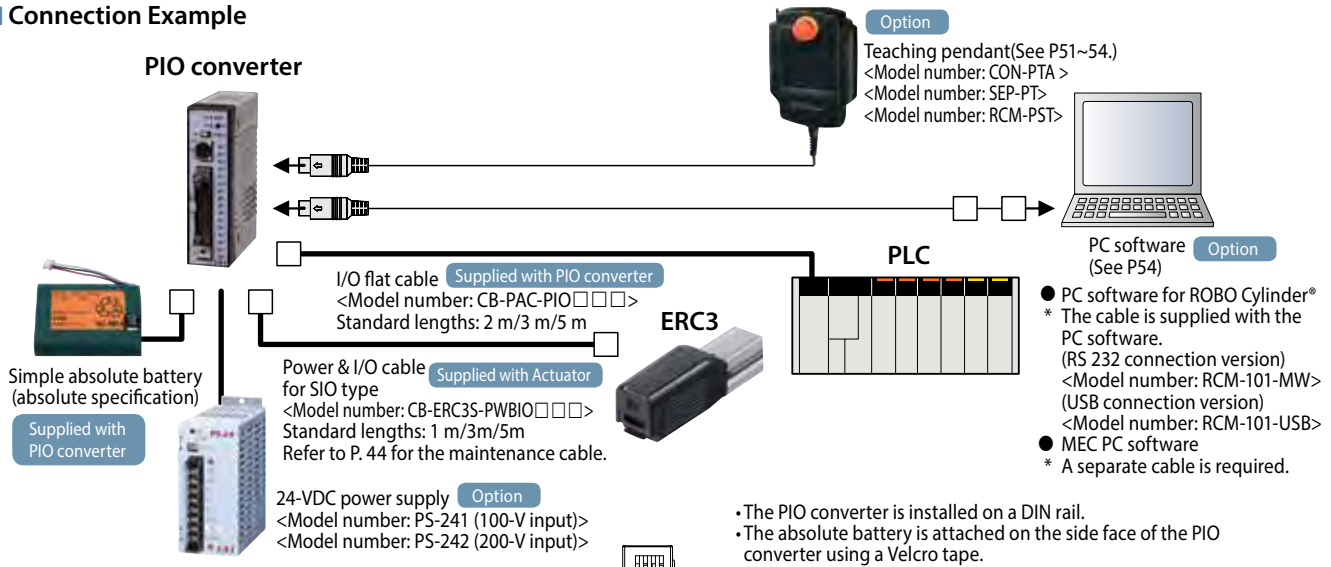

External Dimensions

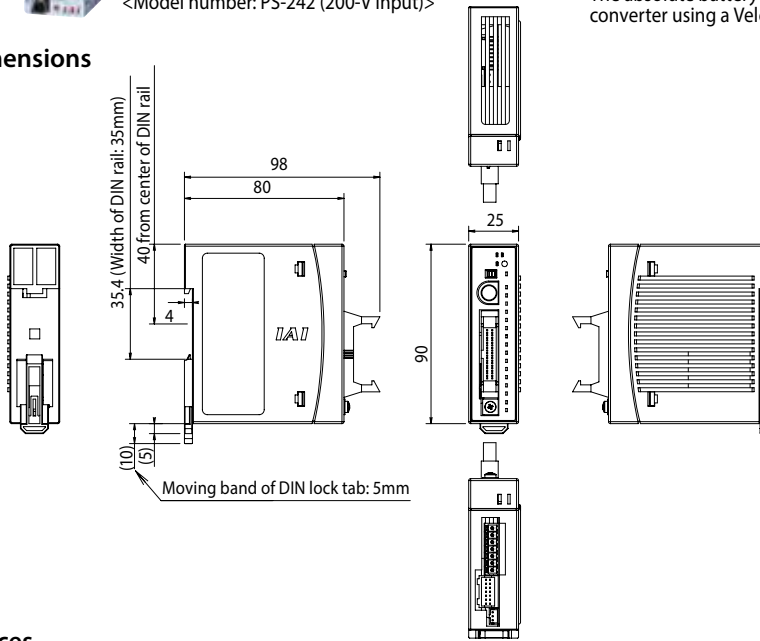

Standard Prices

*① in the model numbers below represents the number indicating I/O cable length.

Power cut-off relay	Monitoring LEDs	Positioning method	Model Numbers	Standard Prices
Built-in type	N/A	Incremental specification	RCB-CV-(NP/PN)-①	—
		Simple absolute specification (with battery)	RCB-CV-(NP/PN)-①-AB	—
		Simple absolute specification (without battery)	RCB-CV-(NP/PN)-①-ABUN	—
	Available	Incremental specification	RCB-CV-(NPM/PNM)-①	—
		Simple absolute specification (with battery)	RCB-CV-(NPM/PNM)-①-AB	—
		Simple absolute specification (without battery)	RCB-CV-(NPM/PNM)-①-ABUN	—
External type	N/A	Incremental specification	RCB-CVG-(NP/PN)-①	—
		Simple absolute specification (with battery)	RCB-CVG-(NP/PN)-①-AB	—
		Simple absolute specification (without battery)	RCB-CVG-(NP/PN)-①-ABUN	—
	Available	Incremental specification	RCB-CVG-(NPM/PNM)-①	—
		Simple absolute specification (with battery)	RCB-CVG-(NPM/PNM)-①-AB	—
		Simple absolute specification (without battery)	RCB-CVG-(NPM/PNM)-①-ABUN	—

I/O Flat Cable

Model number **CB-PAC-PIO□□□**

*□□□ indicates the cable length (L). A desired length can be specified up to 10m. Example: 080=8m

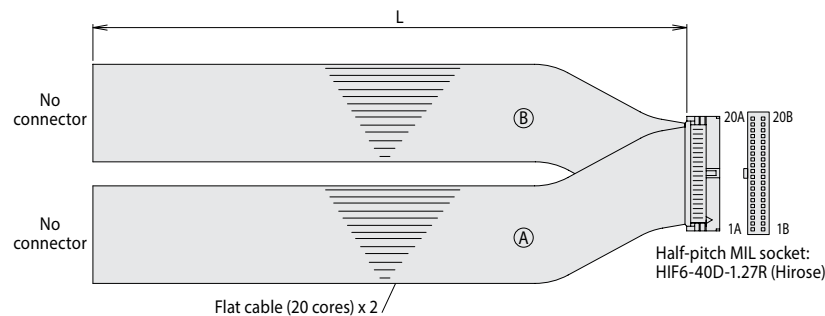

HIF6-40D-1.27R

No.	Signal name	Cable color	Wiring	No.	Signal name	Cable color	Wiring
1A	-	Brown - 1	Flat cable ④ (crimped)	1B	OUT0	Brown - 3	Flat cable ⑤ (crimped) AWG 28
2A	-	Red - 1		2B	OUT1	Red - 3	
3A	-	Orange - 1		3B	OUT2	Orange - 3	
4A	-	Yellow - 1		4B	OUT3	Yellow - 3	
5A	IN0	Green - 1		5B	OUT4	Green - 3	
6A	IN1	Blue - 1		6B	OUT5	Blue - 3	
7A	IN2	Purple - 1		7B	OUT6	Purple - 3	
8A	IN3	Gray - 1		8B	OUT7	Gray - 3	
9A	IN4	White - 1		9B	OUT8	White - 3	
10A	IN5	Black - 1		10B	OUT9	Black - 3	
11A	IN6	Brown - 2		11B	OUT10	Brown - 4	
12A	IN7	Red - 2		12B	OUT11	Red - 4	
13A	IN8	Orange - 2		13B	OUT12	Orange - 4	
14A	IN9	Yellow - 2		14B	OUT13	Yellow - 4	
15A	IN10	Green - 2		15B	OUT14	Green - 4	
16A	IN11	Blue - 2		16B	OUT15	Blue - 4	
17A	IN12	Purple - 2		17B	—	Purple - 4	
18A	IN13	Gray - 2		18B	—	Gray - 4	
19A	IN14	White - 2		19B	—	White - 4	
20A	IN15	Black - 2		20B	—	Black - 4	

Options

Gateway Unit <RCM-EGW>



The ERC3 gateway unit lets you connect up to four ERC3 actuators to implement the gateway function. The gateway unit connects to a PLC or other host control system via a field network. It supports seven network protocols (CC-Link, DeviceNet, PROFIBUS-DP, MECHATROLINK-II, CompoNet, EtherCAT, EtherNet/IP).

- **Features**
 - Use the position adjustment switches on the front panel to jog the actuator
 - The brake release switch for each axis is provided on the front panel

Model Configuration

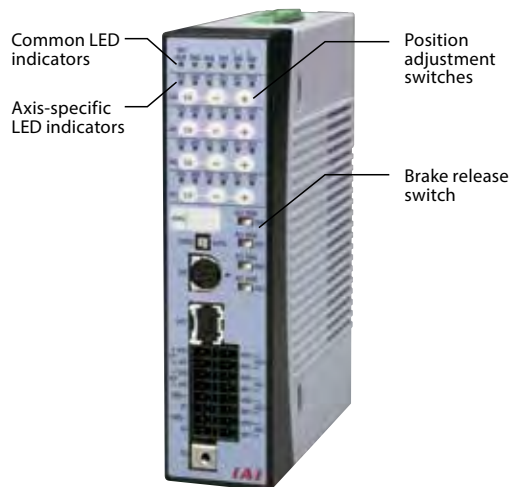
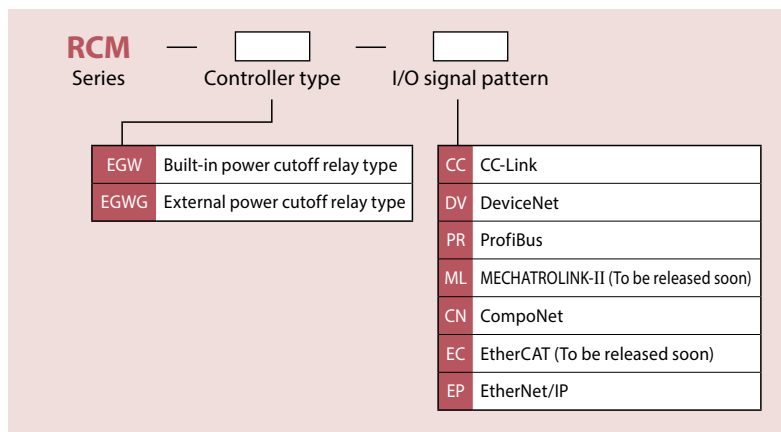

Base Specifications

Item	Description	
Number of controlled axes	Up to 4 axes	
Control/motor power-supply voltage	24 VDC ±10%	
Control power capacity	1 A max.	
Load current (per axis)	High-output setting enabled	3.5 A rated/4.2 A max.
	High-output setting disabled	1.2 A rated/2.2 A max.
Brake release power capacity (per axis)	0.15 A max.	
Rush current (Note)	60 A max.	
Cable length between actuator and gateway unit	10 m max. (A dedicated cable is used)	
Number of positioning points	Up to 512 points (Unlimited in the simple direct mode or direct numerical specification mode) (Note) The number of positioning points varies depending on the operation pattern selected by the parameter.	
Electromagnetic brake forced release	The electromagnetic brake for each axis can be released using the applicable brake forced release switch provided on the front panel.	
Environment	Ambient operating temperature	0~40°
	Ambient operating humidity	85% RH max. (Non-condensing)
	Protection class	IP20

Note) Approx. 50 μs of rush current flows after the power is turned on.

Standard Price

	Built-in power cutoff relay type		External power cutoff relay type	
	Model	Standard price	Model	Standard price
CC-Link connection specification	RCM-EGW-CC	—	RCM-EGWG-CC	—
DeviceNet connection specification	RCM-EGW-DV	—	RCM-EGWG-DV	—
ProfiBus connection specification	RCM-EGW-PR	—	RCM-EGWG-PR	—
MECHATROLINK-II connection specification (*)	RCM-EGW-ML	—	RCM-EGWG-ML	—
CompoNet connection specification	RCM-EGW-CN	—	RCM-EGWG-CN	—
EtherCAT connection specification (*)	RCM-EGW-EC	—	RCM-EGWG-EC	—
EtherNet/IP connection specification	RCM-EGW-EP	—	RCM-EGWG-EP	—

(*) To be released soon

Operation Mode

Operation pattern	Description
Positioner 1/simple direct mode	In the positioner 1 mode, position data of up to 512 points can be registered to stop the actuator at any of the registered positions. The current position can also be monitored. In the simple direct mode, the target position can be specified directly by entering a value. The current position can also be monitored.
Direct numerical specification mode	The target position, speed, acceleration/deceleration and push-current limiting value can be each specified by entering a value. In addition to the current position, the current speed and command current value can also be monitored.
Positioner 2 mode	In this mode, the actuator is operated using the position data of up to 512 points set in the position table. The current position cannot be monitored. The functions available in this mode are the same as those provided in the positioner 1 mode, except that less amount of data can be sent/received.
Positioner 3 mode	In this mode, the actuator is operated using the position data of up to 256 points set in the position table. The current position cannot be monitored. The amount of data sent/received in this mode is further less than that in the positioner 2 mode, and the actuator is controlled using the minimum signals required for positioning.
Remote I/O	The same six functions (Note 1) available with the PIO specification (CON type) can be controlled. The same two functions (Note 2) available with the PIO specification (MEC type) can be controlled.

Note 1) Switched using the ERC3's PIO pattern parameter.

Note 2) Switched using the ERC3's operation pattern parameter.

Control Signals in the Remote I/O Mode

The table below lists the ERC3 functions that can be controlled in each type.

CON Type Specifications

O: Supported X: Not supported

ROBO Cylinder function	Operation pattern (PIO pattern)					
	0	1	2	3	4	5
	Positioning mode	Teaching mode	256-point mode	512-point mode	Solenoid valve mode 1	Solenoid valve mode 2
Home return operation	O	O	O	O	O	X (Note 1)
Positioning operation	O	O	O	O	O	O
Speed & acceleration/deceleration setting	O	O	O	O	O	O
Pitch feed (inching)	O	O	O	O	O	O
Push-motion operation	O	O	O	O	O	X
Speed change while moving	O	O	O	O	O	O
Operation at different acceleration/speed	O	O	O	O	O	O
Pause	O	O	O	O	O	O (Note 2)
Zone signal output	O	O	O	X	O	O
PIO pattern selection	O	O	O	O	O	O

Note 1) Home return is performed with the first move command.

Note 2) Supported if ERC3 Parameter No. 27, "Move command type" is set to "0."

MEC Type Specifications

ROBO Cylinder function	Operation pattern	
	1-input, 2-point move	2-input, 3-point move
Home return operation	X (Note 1)	X (Note 1)
Positioning operation	O	O
Speed & acceleration/deceleration setting	O	O
Pitch feed (inching)	X	X
Push-motion operation	O	O
Speed change while moving	X	X
Operation at different acceleration/speed	O	O
Pause	X	O
Zone signal output	X	X

Note 1) Home return is performed with the first move command.

Example of Connection

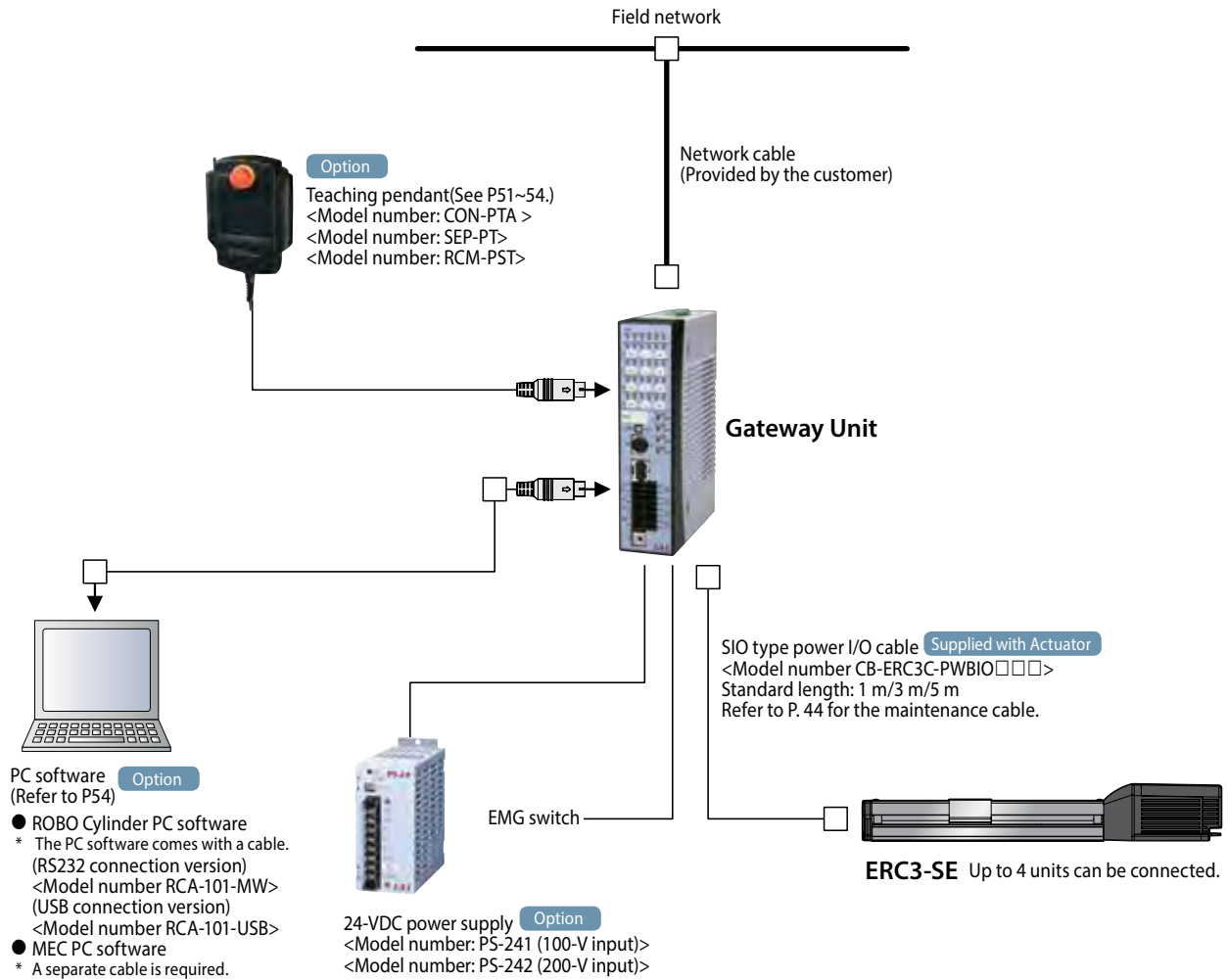

External Dimensions

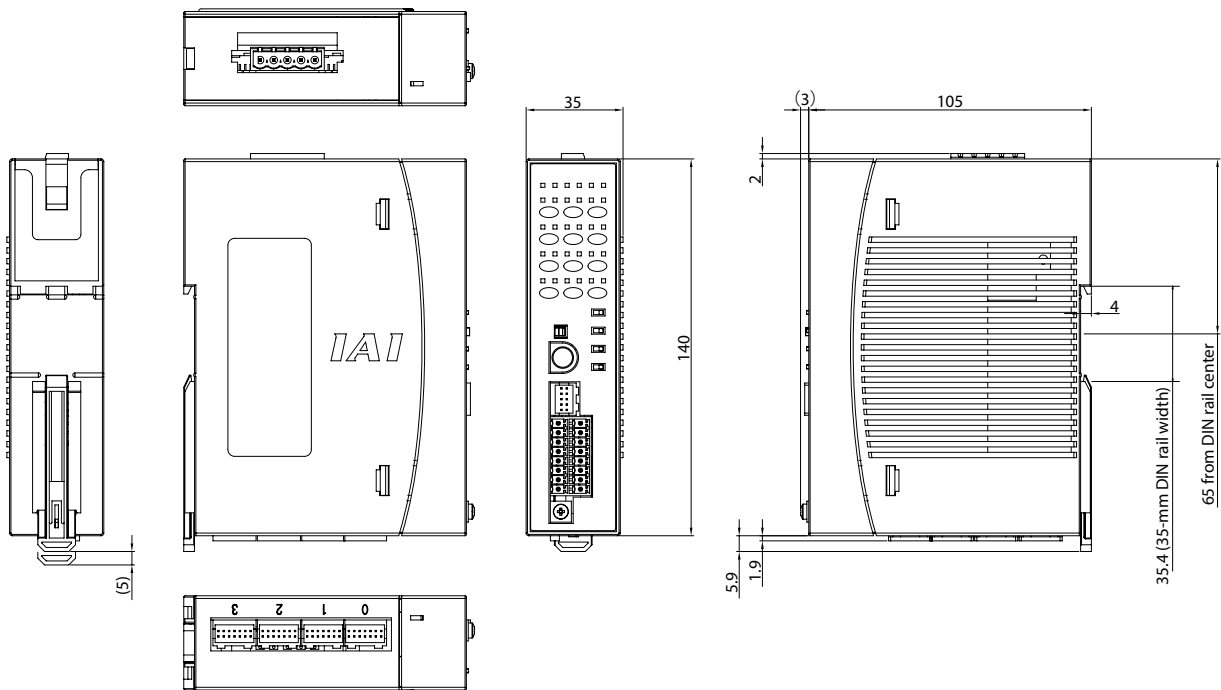

Notes on Selecting Teaching Pendant and PC Software

With the ERC3 series, usable teaching pendant and PC software vary depending on the controller type (CON type/MEC type). Refer to P.5 for controller types.

Teaching pendant

Controller type	CON-PTA	RCM-PST	SEP-PT
CON type	○	△	—
MEC type	○	○	○

PC software

Controller type	RCM-101-MW	RCM-101-USB	MEC PC software
CON type	○	○	—
MEC type	—	—	○

○: All functions are supported / △: Limited functions are supported (home return, servo ON/OFF, JOG+, JOG-, stop (press and hold to reset alarms))

Options

Quick Teach <RCM-PST>



A teaching pendant equipped with intuitive operation buttons and acceleration/speed knobs that can be used easily even by mechanical engineers and those who never operated a robot before.

- **Features**
 - User-friendly panel sheet switches and knobs let you complete the settings in no time.
 - The small pendant can be held in a hand.
 - Separate power-supply unit

■ **Model configuration**

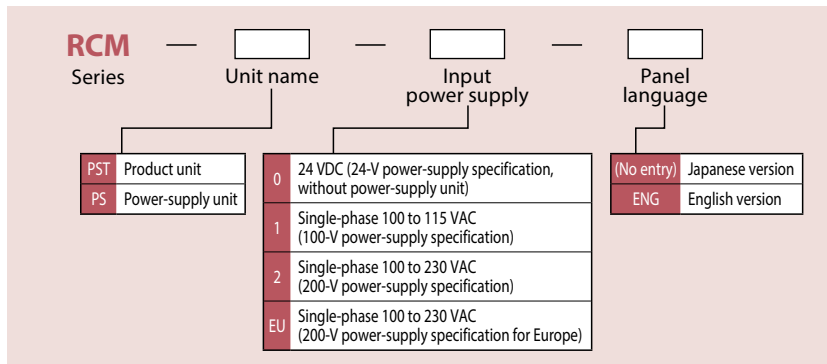

■ **Base Specifications**

Item	Description			
Product name	24-VDC specification	100-VDC specification	200-VDC specification	200-V power-supply specification for Europe (Note 2)
Product model	RCM-PST-0	RCM-PST-1	RCM-PST-2	RCM-PST-EU
Product configuration	Teaching pendant	RCM-PST-0		
	Power-supply unit	(Teaching pendant only)	RCM-PS-1	RCM-PS-2
Power supply voltage	24 VDC±10% (DC 21.6V to DC 26.4V)	Single-phase 100 to 115 VAC±10% (AC 90V to AC 126.5V)	Single-phase 100 to 230 VAC±10% (AC 90V to AC253 V)	Single-phase 100 to 230 VAC±10% (AC90V~AC253V)
Load capacity (motor power capacity) of connected ERC3 (Note 1)	ERC3	Rated		Maximum
	42P	1.2A		2.2A
	56P	1.2A		2.2A
Number of controlled axes	1 axis			
Environment conditions	Operating temperature range: 0 to 40°C Operating humidity range: 85% RH or less (non-condensing) Storage temperature range: -20°C to 70°C			
Protection degree	IP20			
Power-supply frequency	50Hz/60Hz			
Pollution degree	Pollution degree 2			
Leak current	—	0.5mA max	0.75mA max	
Cooling method	Natural air cooling			
Cable length	Actuator cable: 10m or less AC cable: 2m SIO communication cable (optional): 5m			
Product size	65 (W) x 157 (H) x 21.6 (D)	65 (W) x 157 (H) x 64.4 (D)		
Weight *Excluding connection cables	120g	540g	535g	
Standard price	—	—	—	—

Note 1) If an ERC3 actuator whose high-output setting is enabled is used to perform test run using the Quick Teach connected to the above power-supply unit, the ERC3 may not operate as specified. (Position data can be edited without problems.)

If test run is performed with the actuator's high-output setting enabled, connect a 24-VDC power supply to the Quick Teach. In this case, disconnect the power-supply unit.

Note 2) The CE Mark-compliant 200-V power-supply specification for Europe will be released soon.

Connection Example

Supplying power from the Quick Teach to the ERC3

<Using a 24-VDC power supply>

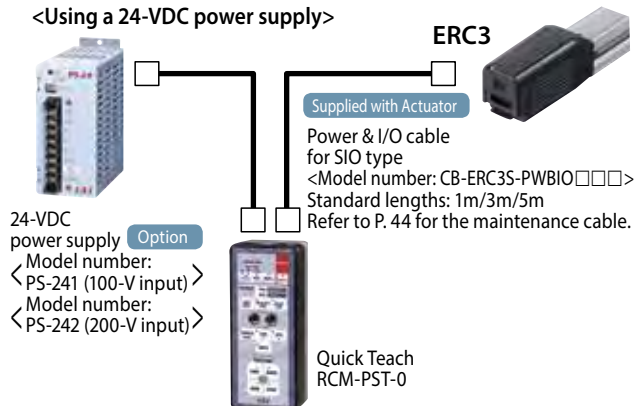

<Using a 100/200-VAC power supply>

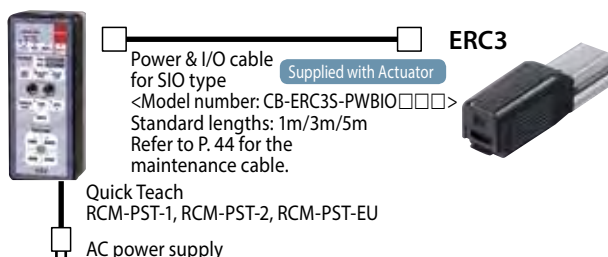

Connecting the Quick Teach to the ERC3 supplied with power

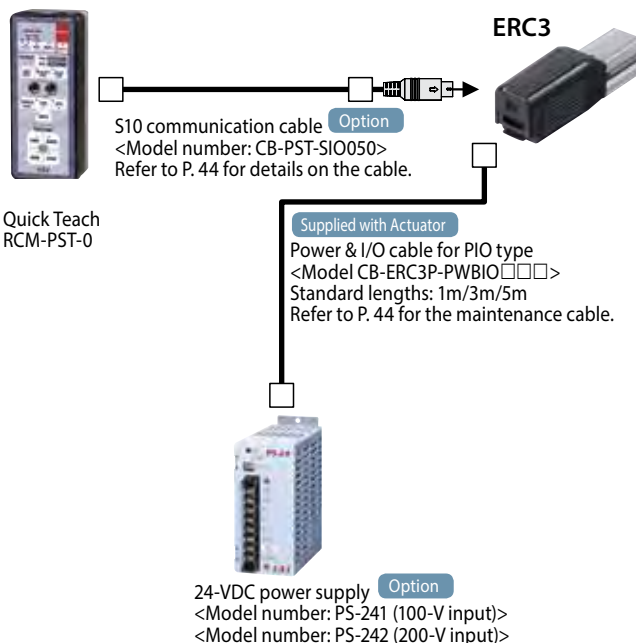

Name and Function of Each Part/External Dimensions

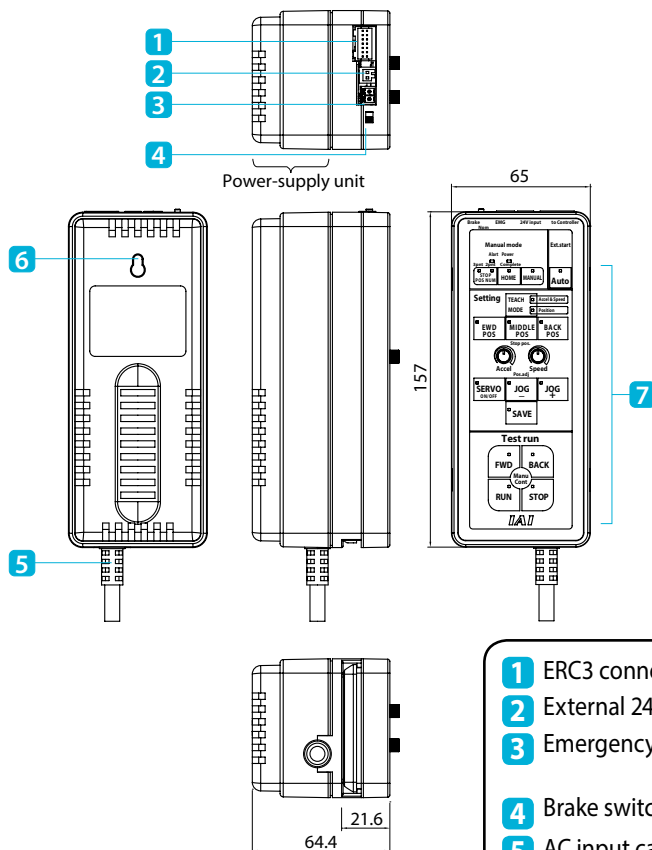

<Quick Teach and Model Numbers>

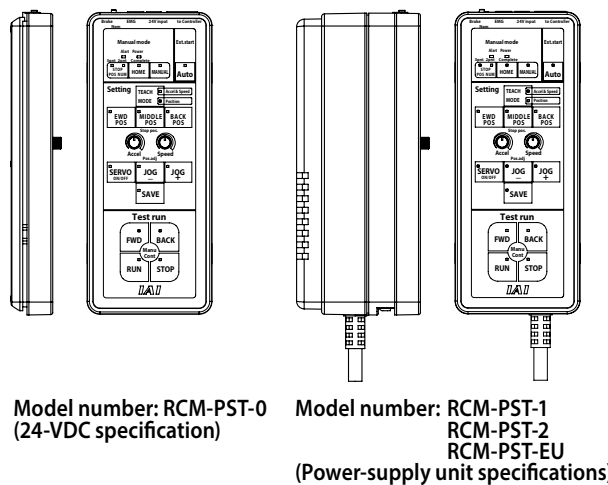

Shown above are the external dimensions of the Quick Teach with power-supply unit (model number: RCM-PST-1/2/EU). The 24-V power-supply specification (model number: RCM-PST-0) has no power-supply unit.

- 1 ERC3 connector..... For cable connection with the ERC3.
- 2 External 24-V connector 24 VDC±10%. * Supplied with a plug connector.
- 3 Emergency stop connector Connect an emergency stop switch. * Supplied with a plug connector.
- 4 Brake switch Forced release switch for an actuator with brake.
- 5 AC input cable Single-phase 100 or 230-V input. * Varies depending on the product.
- 6 Wall-mounting hook..... The hook can be secured with M3 or equivalent screws or bolts (screw head size: Ø6 or less).
- 7 Operation switches..... Panel sheet switches

Options

Touch-panel Teaching Pendant for Position Controller



Developed based on the design of the popular CON-PT series adopting an easy-to-use interactive touch-panel menu screen, this new data input device supports various functions offered by the ERC3 series controller.



CON-PTA

1. Color screen for greater ease of view
2. Supporting the takt time minimization function and maintenance information checking/ input functions of the ERC3 series
3. Position, parameters and other data can be saved in a SD card
4. Built-in clock function records the date & time of each event; data can then be saved in a SD card.

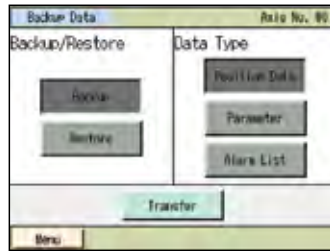

Model Numbers/Specifications

Item	Description		
Model number	CON-PTA-C-ENG	CON-PDA-C-ENG	CON-PGA-C-S-ENG
Type	Standard type	Enable switch type	Safety-category compliant type
Connectable controllers	ACON/PCON/SCON/RACON/RPCON/MSCON	ASEP/PSEP/MSEP/DSEP	AMEC/PMEC ERC2 (*1) /ERC3
3-position enable switch	×	○	○
Functions	<ul style="list-style-type: none"> • Position data input/editing • Moving function (moving to set positions, jogging/inching) • Parameter editing • Monitoring (current position, current speed, I/O signals, alarm code, alarm generation time) • Saving/reading data to/from external SD cards (position data parameters, alarm list) • Takt time minimization function • Maintenance information (total number of movements, total distance travelled, etc.) 		
Display	65536 colors (16-bit colors), white LED backlight		
Ambient operating temperature/humidity	0 to 50°C, 20 to 80% RH (non-condensing)		
Environmental resistance	IP40 or equivalent		
Mass	Approx. 570g		Approx. 600g
Cable length		5m	
Accessories	Stylus	Stylus	Stylus, TP adapter (Model number: RCB-LB-TG) Dummy plug (Model number: DP-4) Controller cable (Model number: CB-CON-LB005)

*1 Among the ERC2 series, only the actuators bearing 4904 or greater number stamped on the serial number label can be connected.

Name of Each Part

■ Name of Each Part/External Dimensions

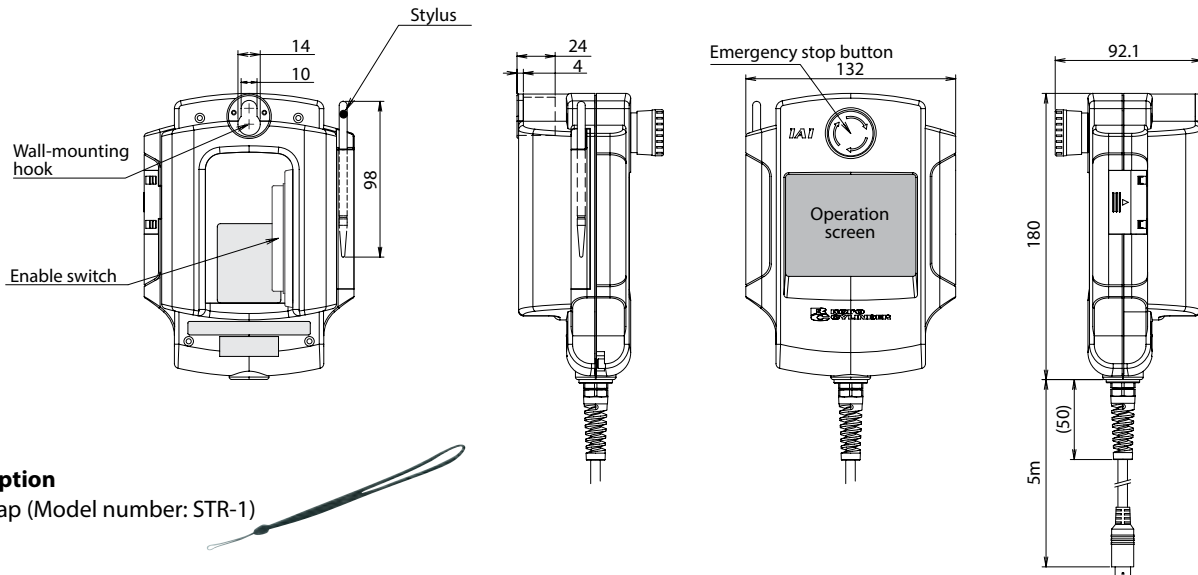

■ Option

- Strap (Model number: STR-1)

Options

Touch-panel Teaching Pendant for Position Controller SEP-PT

- **Features** Teaching device offering position input, test run, monitoring and other functions.
*This teaching pendant can be used when the ERC3's controller type is set to "MEC type."

SEP-PT version 3.00 or later is supported.

■ **Specifications**

Item	SEP-PT
Data input	○
Actuator operation	○
Ambient operating temperature/humidity	Temperature 0 to 40°C, humidity 85%RH or less
Operating ambience	Free from corrosive gases or significant powder dust.
Protection degree	IP40
Mass	Approx. 550g
Cable length	5m
Display	3-color LED touch panel with backlight
Standard price	—

■ **Configuration**

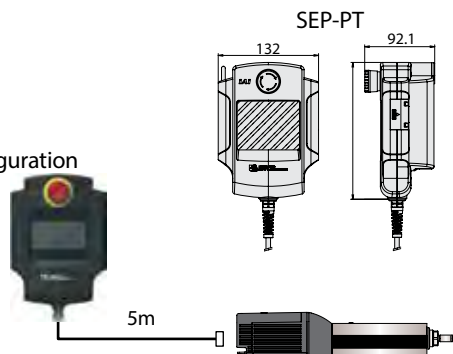

■ PC Software (Windows Only)

- **Features** This startup support software provides functions to input positions, perform test runs and monitor data, among others. Incorporating all functions needed to make adjustments, this software helps shorten the initial startup time.
*This software can be used when the ERC3's controller type is set to "CON type."

PC software version 8.03.00.00 or later is supported.

- **Model number** **RCM-101-MW**
(With external device communication cable + RS232 conversion unit)

■ **Configuration**

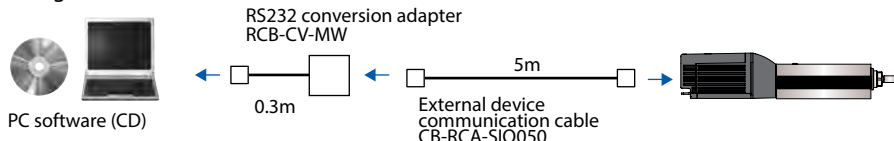

- **Model number** **RCM-101-USB**
(With external equipment communication cable + USB conversion adapter + USB cable)

■ **Configuration**

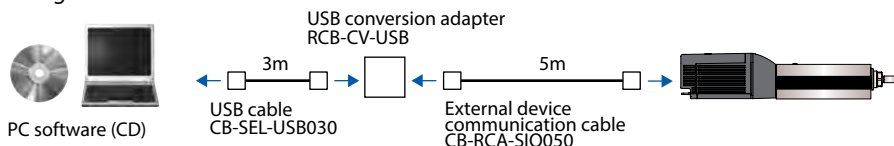

■ MEC PC Software

You can change the stop position data, perform test run and do many other things on a PC using the MEC PC software. This software also lets you use the middle stop function, perform push-motion operation, change the coordinates, etc., with ease. The MEC PC software can be downloaded on the IAI's website.

The MEC PC software can be used with the version 2.00.00.00 or later.

IAI's website: www.intelligentactuator.com

*This software can be used when the ERC3's controller type is set to "MEC type."

The cable supplied with the above "PC software (RCM-101-MW/RCM-101-USB)" can be used to connect the PC and ERC3 series. To purchase a cable separately, select an appropriate cable/adapter by referring to the table below.

PC connection method	Model	Name	Price
RS232	CB-RCA-SIO050	External device communication cable	—
	RCB-CV-MW	RS232 conversion adapter	—
USB	CB-RCA-SIO050	External device communication cable	—
	RCB-CV-USB	USB conversion adapter	—
	CB-SEL-USB030	USB cable	—

IAI America, Inc.

Headquarters: 2690 W. 237th Street, Torrance, CA 90505 (800) 736-1712

Chicago Office: 1261 Hamilton Parkway, Itasca, IL 60143 (800) 944-0333

Atlanta Office: 1220 Kennestone Circle, Suite 108, Marietta, GA 30066 (888) 354-9470

www.intelligentactuator.com

The information contained in this product brochure may change without prior notice due to product improvements.

IAI Industrieroboter GmbH

Ober der Röth 4, D-65824 Schwalbach am Taunus, Germany

IAI Robot (Thailand), CO., Ltd.

825 PhairojKijja Tower 12th Floor, Bangna-Trad RD.,

Bangna, Bangna, Bangkok 10260, Thailand

